

LUXEON 3535 Mid-Power LEDs

Illumination Portfolio



Introduction

LUXEON® 3535 delivers optimized performance in combination with quality of light needed for distributed light source applications. In addition to delivering specified correlated color temperature and color rendering combinations, these emitters deliver the efficacy and reliability required by the indoor illumination markets. This document contains the performance data needed to design and engineer applications based on these LUXEON 3535 emitters.

Features and Benefits

- High efficacy for sustainable design
- Compact 3535 package
- Minimum 70 and 80 CRI for both indoor and outdoor applications
- ANSI compliant 1/6th color binning
- Supports ENERGY STAR® lumen maintenance certification requirements

Key Applications

- Lamps
- Indoor Area Lighting
- Downlight
- Outdoor
- Architecture
- High bay & Low bay

Table of Contents

General Information	2
Product Nomenclature	2
Average Lumen Maintenance Characteristics	2
Environmental Compliance	2
Product Selection	3
Optical Characteristics	4
Electrical Characteristics	5
Absolute Maximum Ratings	5
JEDEC Moisture Sensitivity	5
Reflow Soldering Characteristics	6
Mechanical Dimensions	7
Solder Pad Design	8
Relative Spectral Distribution	9
Light Output Characteristics	10
Luminous Efficacy Characteristics	11
Forward Current Characteristics	12
Typical Radiation Patterns	13
Emitter Pocket Tape Packaging	15
Emitter Reel Packaging	16
Product Binning and Labeling	17
Forward Voltage Bins	18
Color Bin Structure	19

General Information

Product Nomenclature

LUXEON Mid-Power Illumination emitters are tested and binned at 100 mA, with current pulse duration of 20 ms. All characteristic charts where the thermal pad is kept at constant temperature (25°C typically) are measured with current pulse duration of 20 ms.

The part number designations for the MXM8 series is explained as follows:

M X M A - B C D E - I J K L

Where:

- A — designates minimum CRI performance (value 7 = 70 minimum and 8 = 80 minimum)
- B — designates radiation pattern (value P = Lambertian)
- C — designates color (value W = White)
- D, E — designates nominal ANSI CCT (for example, 30 = 3000K and 40 = 4000K)
- I, J, K & L — designates additional part numbers

Therefore products in this series with minimum CRI value of 80, CCT of 4000K will have the part numbering scheme:

M X M 8 - P W 4 0

Average Lumen Maintenance Characteristics

Lumen maintenance for solid-state lighting devices (LEDs) is typically defined in terms of the percentage of initial light output remaining after a specified period of time.

Environmental Compliance

Philips Lumileds is committed to providing environmentally friendly products to the solid-state lighting market. LUXEON Mid-Power LEDs are compliant to the European Union directives on the restriction of hazardous substances in electronic equipment, namely REACH and the RoHS directive. Philips Lumileds will not intentionally add the following restricted materials to these LEDs: lead, mercury, cadmium, hexavalent chromium, polybrominated biphenyls (PBB) or polybrominated diphenyl ethers (PBDE).

Product Selection

Product Selection for Mid-Power LEDs

Solder Pad Temperature = 25°C, Test Current = 100 mA

Table 1.

Nominal CCT	Part Number	Minimum CRI	Typical CRI	Typical R9	Minimum Luminous Flux (lm) ϕ_v	Typical Luminous Flux (lm) ϕ_v
2700K	MXM8-PW27-0000	80	82	10	28	32
3000K	MXM8-PW30-0000	80	82	10	30	33
3500K	MXM8-PW35-0000	80	82	10	30	34
4000K	MXM8-PW40-0000	80	82	10	32	36
5000K	MXM8-PW50-0000	80	82	10	32	36
5700K	MXM8-PW57-0000	80	82	10	32	36
6500K	MXM8-PW65-0000	80	82	10	32	36

Product Selection for Mid-Power LEDs

Solder Pad Temperature = 25°C, Test Current = 100 mA

Table 2.

Nominal CCT	Part Number	Color Rendering Index		Minimum Luminous Flux (lm) ϕ_v	Typical Luminous Flux (lm) ϕ_v
		Minimum	Typical		
4000K	MXM7-PW40-0000	70	72	32	39
5000K	MXM7-PW50-0000	70	73	32	39
5700K	MXM7-PW57-0000	70	73	32	39
6500K	MXM7-PW65-0000	70	74	32	39

Note for Tables 1 & 2:

I. Philips Lumileds maintains a tolerance of $\pm 7.5\%$ on luminous flux and ± 2 on CRI measurements.

Optical Characteristics

Optical Characteristics of Mid-Power LEDs

Solder Pad Temperature = 25°C, Test Current = 100 mA

Table 3.

Nominal CCT	Color Temperature CCT			Typical Total Included Angle ^[1] (degrees) $\theta_{0.90V}$	Typical Viewing Angle ^[2] (degrees) $2\theta_{1/2}$
	Minimum	Typical	Maximum		
2700K	2550K	2700K	2850K	150	115
3000K	2850K	3000K	3200K	150	115
3500K	3200K	3500K	3750K	150	115
4000K	3750K	4000K	4250K	150	115
5000K	4700K	5000K	5300K	150	115
5700K	5300K	5700K	6000K	150	115
6500K	6000K	6500K	7000K	150	115

Notes for Table 3:

1. Total angle at which 90% of total luminous flux is captured.
2. Viewing angle is the off axis angle from lamp centerline where the luminous intensity is $\frac{1}{2}$ of the peak value.

Electrical Characteristics

Electrical Characteristics of Mid-Power LEDs

Thermal Pad Temperature = 25°C, Test Current = 100 mA

Table 4.

Part Number	Forward Voltage V_f ^[1] (V)			Typical Temperature Coefficient of Forward Voltage ^[2] (mV/°C) $\Delta V_f / \Delta T_j$	Typical Thermal Resistance Junction to Solder Pad (°C/W) $R\theta_{j-c}$
	Minimum	Typical	Maximum		
MXM8-PW27-0000 MXM8-PW30-0000 MXM8-PW35-0000 MXM8-PW40-0000 MXM8-PW50-0000 MXM8-PW57-0000 MXM8-PW65-0000	2.80	3.10	3.40	-2.0 to -4.0	20

Notes for Table 4:

1. Philips Lumileds maintains a tolerance of $\pm 0.10V$ on forward voltage measurements.
2. Measured at T_j between 25°C and 110°C.

Absolute Maximum Ratings

Table 5.

Parameter	Maximum Performance
DC Forward Current (mA) ^[1]	150
Peak Pulsed Forward Current (mA) ^[2]	180
ESD Sensitivity	Class 3A Human Body Model Class C Machine Model
LED Junction Temperature ^[3]	115°C
Operating Case Temperature at 100 mA	-40°C - 105°C
Storage Temperature	-40°C - 100°C
Soldering Temperature	JEDEC 020D 260°C
Allowable Reflow Cycles	3
Reverse Voltage (Vr) ^{[4],[5]}	-5V

Notes for Table 5:

1. Ripple current with a frequency of 50-150 Hz is allowed, as long as the average of the current waveform is below 150 mA, and the maximum of the current waveform is lower than 180 mA.
2. At 10% duty cycle and pulse width 10ms.
3. Proper current derating must be observed to maintain junction temperature below the maximum.
4. LUXEON Mid-Power LEDs are not designed to be driven in reverse bias.
5. At maximum reverse current of 10 μA .

JEDEC Moisture Sensitivity

Table 6.

Level	Floor Life		Soak Requirements Standard	
	Time	Conditions	Time	Conditions
2	1 year	$\leq 30^\circ C / 60\% RH$	168 Hrs. + 5 / - 0 Hrs.	$\leq 85^\circ C / 60\% RH$

Reflow Soldering Characteristics

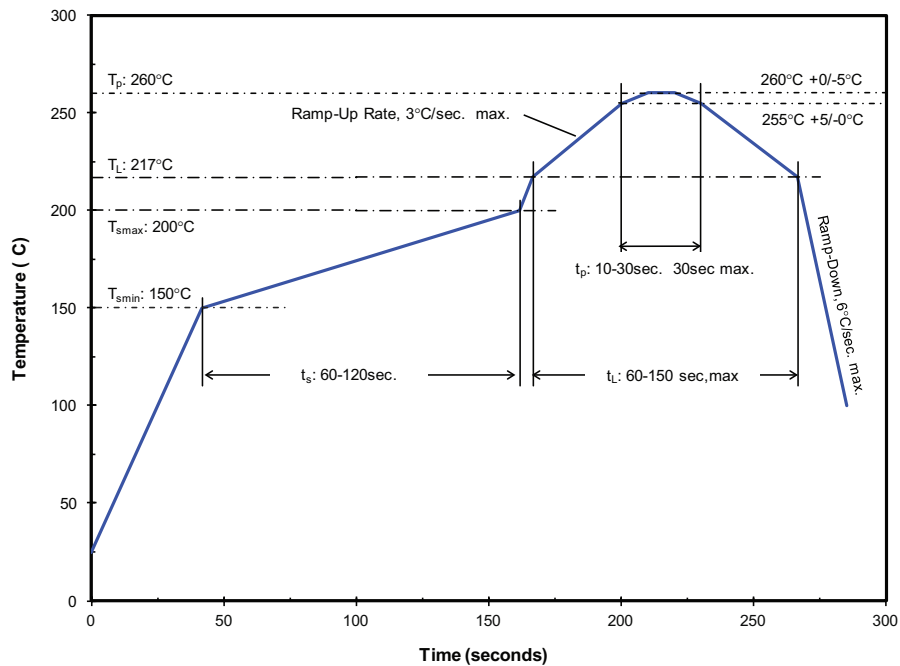

Figure 1. Temperature profile for Table 7.

Table 7. Reflow Profile in Accordance with J-Std-020D.

Profile Feature	Lead Free Assembly
Preheat/Soak :	
Temperature Min (T_{smin})	150°C
Temperature Max (T_{smax})	200°C
Maximum Time (t_s) from T_{smin} to T_{smax}	120 seconds
Ramp-up Rate (T_L to T_p)	3°C / second
Liquidous Temperature (T_L)	217°C
Maximum Time (t_L) Maintained above T_L	150 seconds
Maximum Peak Package Body Temperature (T_p)	260°C
Time (t_p) within 5°C of the specified temperature (T_c)	10-30 seconds
Maximum Ramp-Down Rate (T_p to T_L)	6°C / second
Maximum Time 25°C to Peak Temperature	8 minutes

Note for Table 7:

I. All temperatures refer to the application Printed Circuit Board (PCB), measured on the surface adjacent to the package body.

Mechanical Dimensions

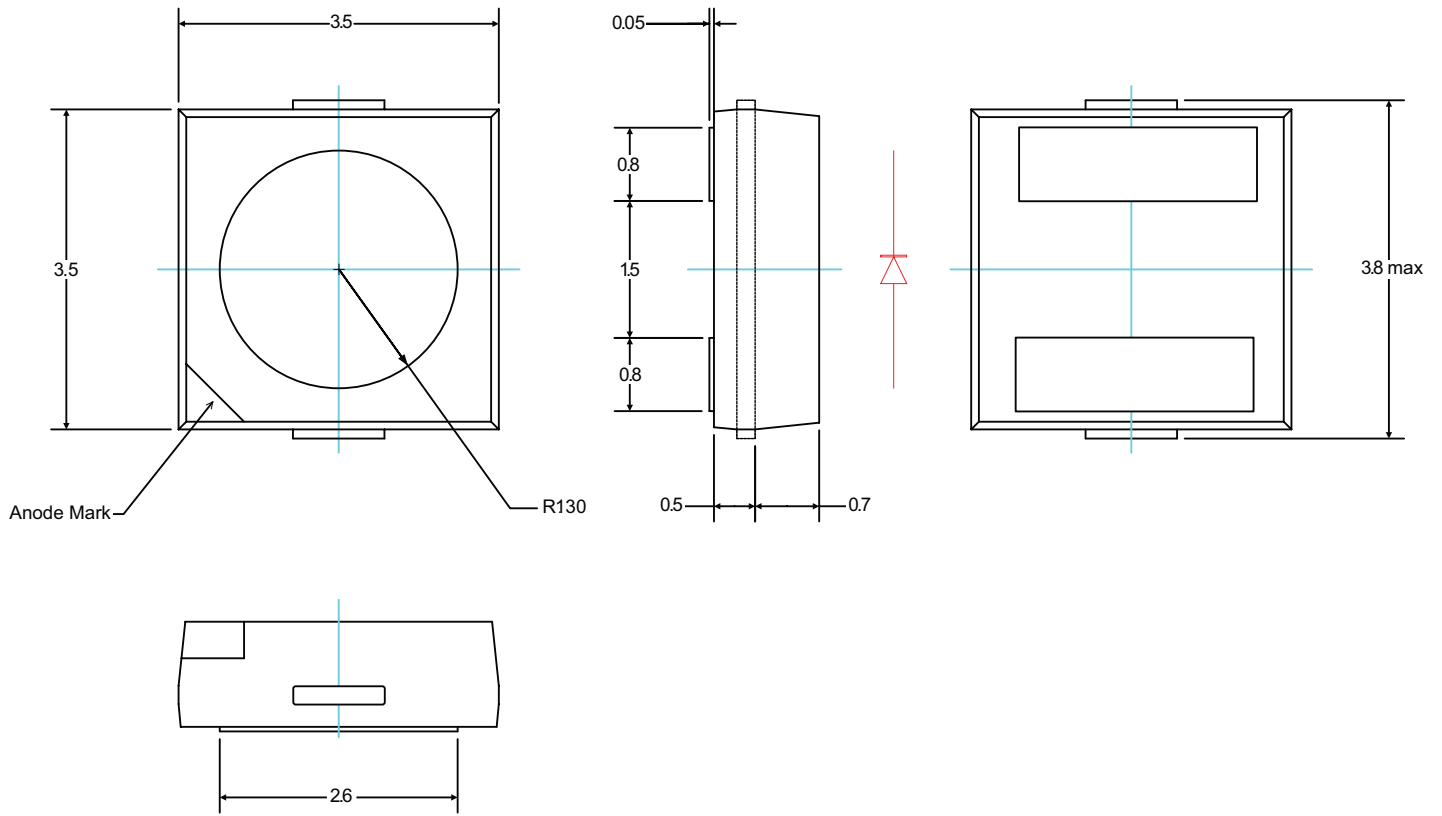

Figure 2. Package outline drawing.

Notes for Figure 2:

1. All dimensions are in millimeters.
2. Tolerance: $\pm 0.10\text{mm}$.
3. Materials
 - Lead Frame: Copper Alloy with Silver Plating
 - Package Body: High Temperature Thermal Plastic
 - Encapsulant: Silicone Resin
 - Solder Lead Finish: Sn-Sn Plating

Solder Pad Design

Recommended Solder Pad Dimensions

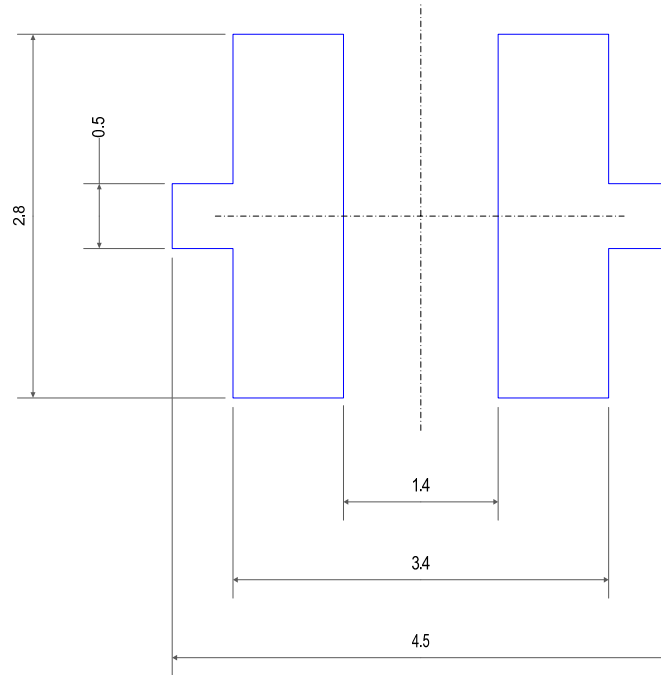

Recommended Pad Layout Dimensions

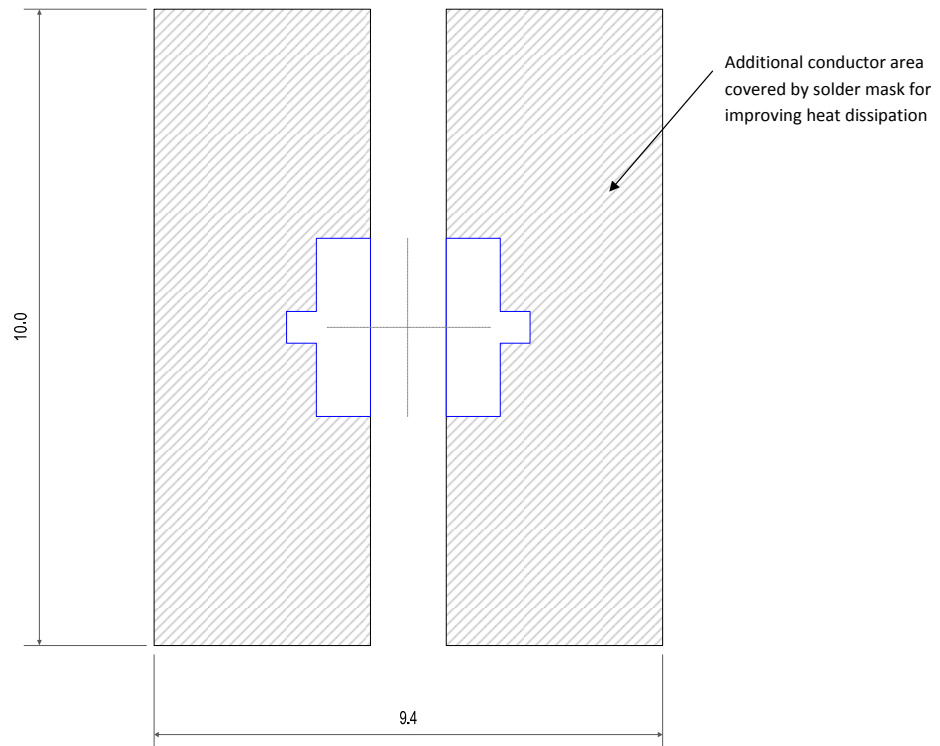

Figure 3. Solder pad layout.

Notes for Figure 3:

1. The drawing above shows the recommended solder pad layout on Printed Circuit Board (PCB).
2. Application Brief AB202 provides extensive details for this layout. In addition, the .dwg files are available at www.philipslumileds.com and www.philipslumileds.cn.com.

Relative Spectral Distribution

Relative Intensity vs. Wavelength, MXM7-PWXX

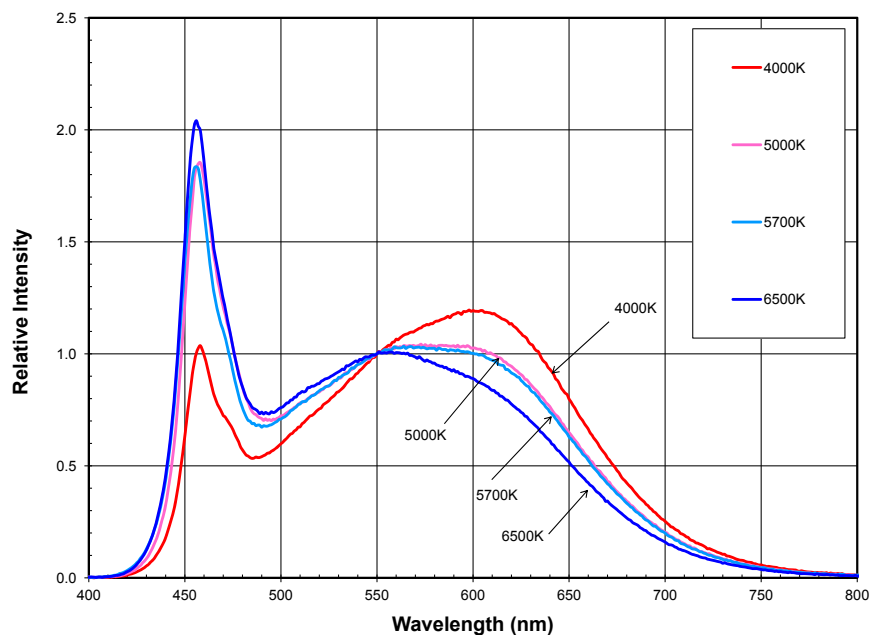

Figure 4. Typical color spectrum of MXM7-PWXX emitter, integrated measurement at solder pad temperature = 25°C, forward current = 100 mA.

Relative Intensity vs. Wavelength, MXM8-PWXX

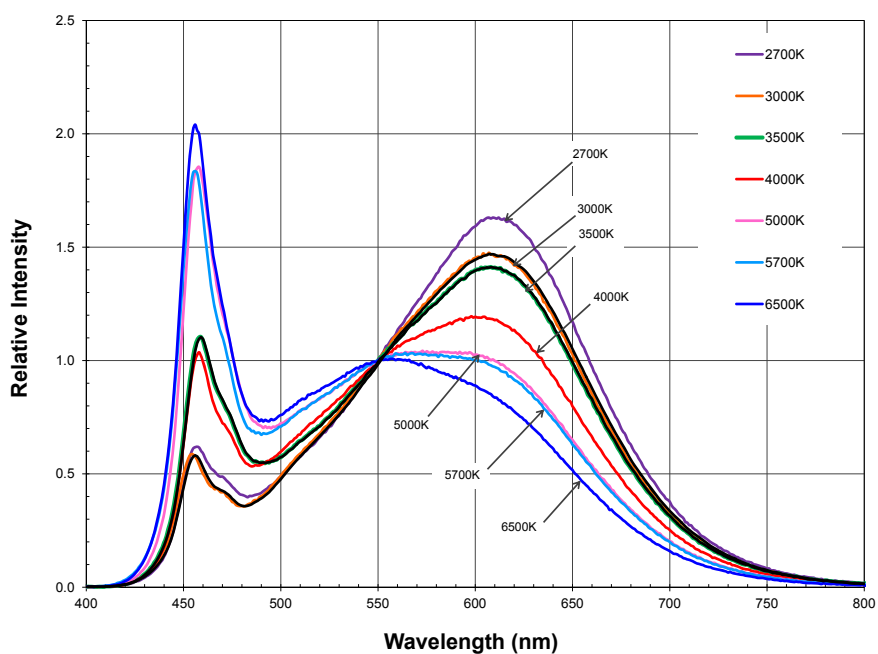

Figure 5. Typical color spectrum of MXM8-PWXX emitter, integrated measurement at solder pad temperature = 25°C, forward current = 100 mA.

Light Output Characteristics

Relative Flux over Temperature MXM8-PWXX/MXM7-PWXX

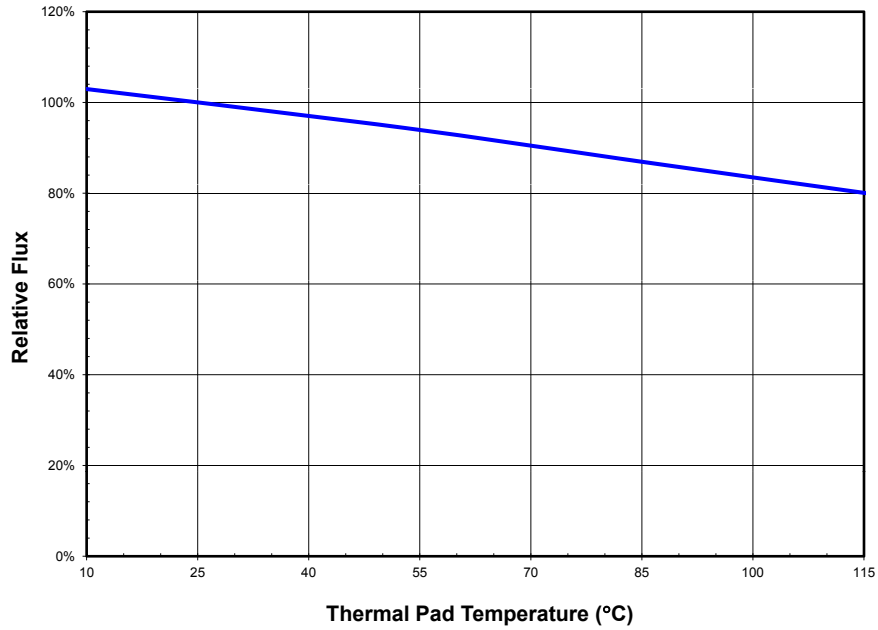

Figure 6. Typical relative light output vs. thermal pad temperature, forward current = 100 mA.

Relative Flux vs. Forward Current MXM8-PWXX/MXM7-PWXX

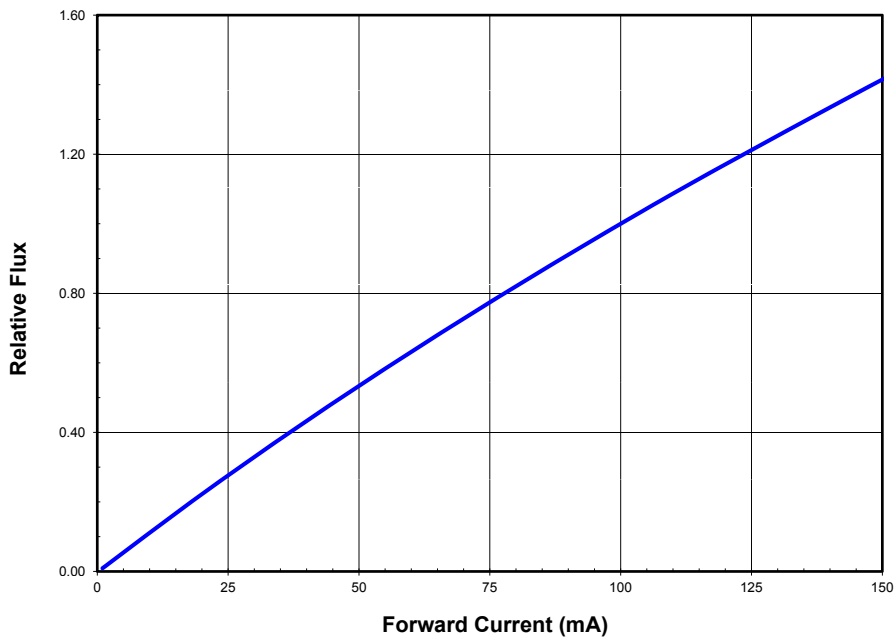

Figure 7. Typical relative luminous flux vs. forward current, solder pad temperature = 25°C.

Luminous Efficacy Characteristics

Relative Luminous Efficacy vs. Forward Current MXM8-PWXX/MXM7-PWXX

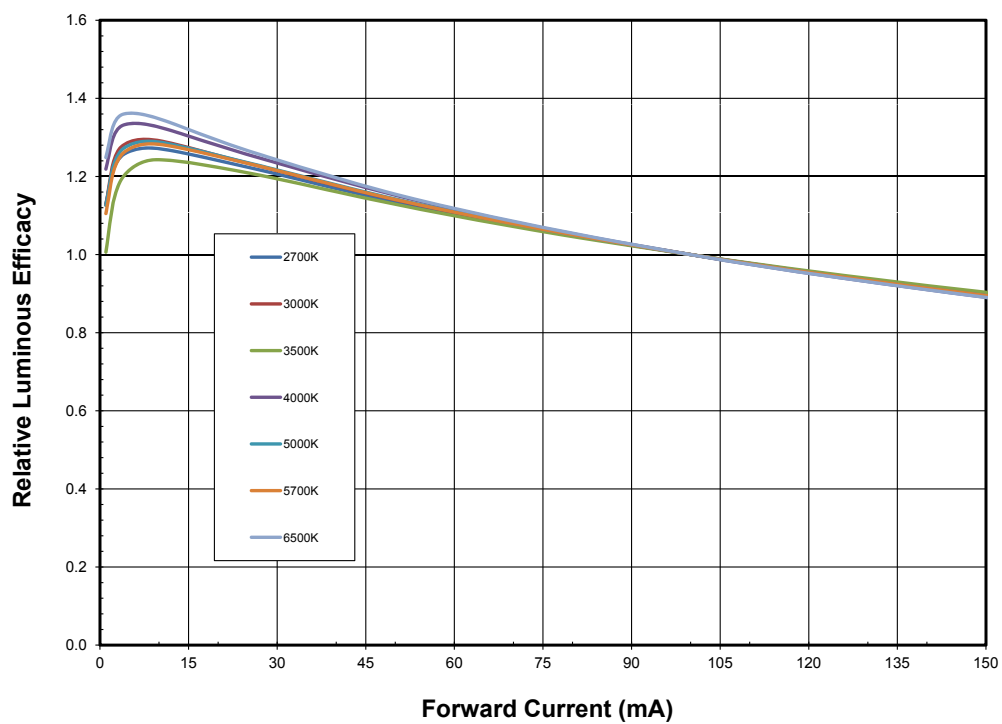

Figure 8. Typical emitter efficacy versus forward current, solder pad temperature = 25°C.

Forward Current Characteristics

Forward Current vs. Forward Voltage MXM8-PWXX/MXM7-PWXX

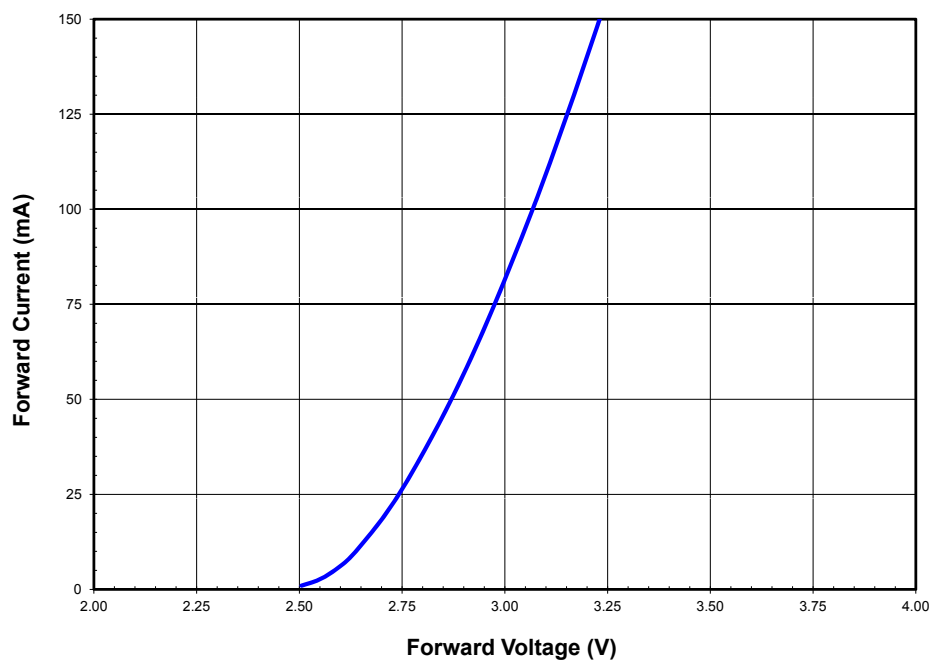

Figure 9. Typical forward current vs. forward voltage, solder pad temperature = 25°C.

Typical Radiation Patterns

Radiation Pattern in Cartesian Coordinate System

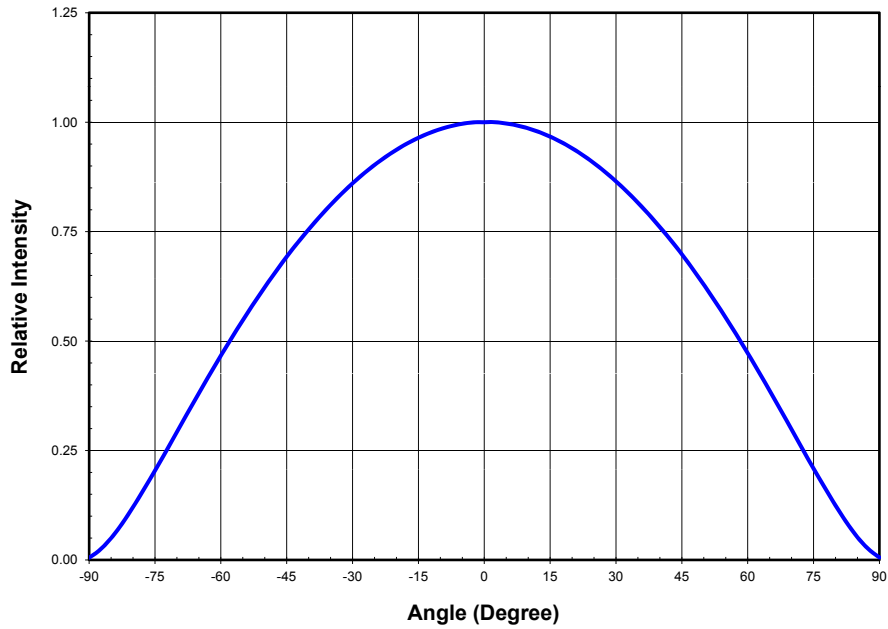

Figure 10. Typical representative spatial radiation pattern.

Radiation Pattern in Polar Coordinate System

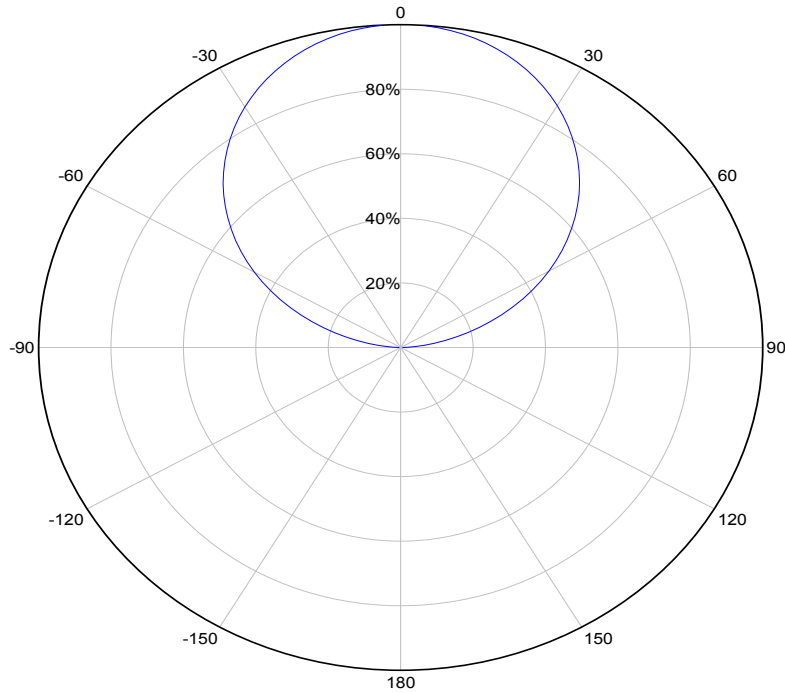

Figure 11. Typical polar plot of radiation pattern.

Color Shift vs. Viewing Angle

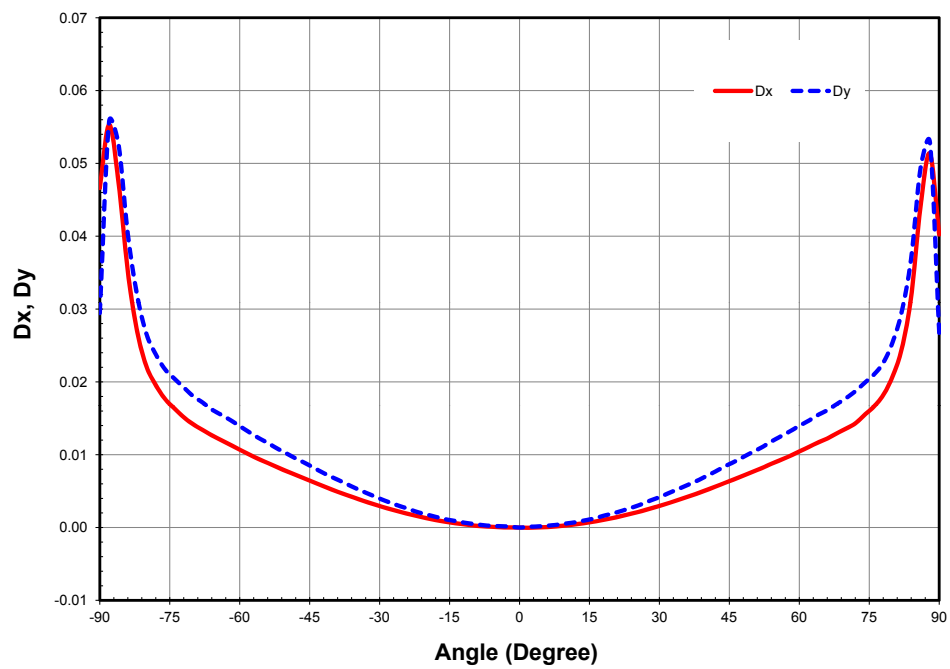

Figure 12. Typical plot of color shift vs. viewing angle.

Emitter Pocket Tape Packaging

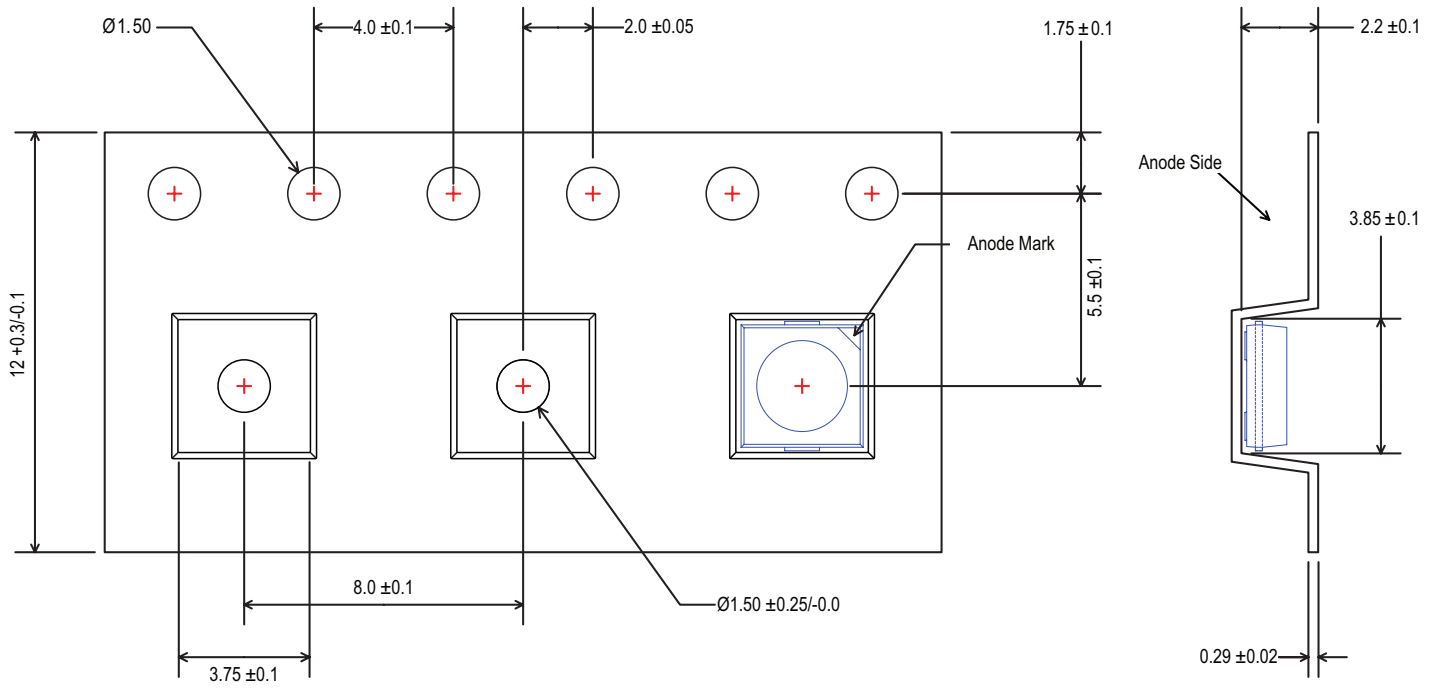

Figure 13. Emitter pocket tape packaging.

Notes for Figure 13:

1. All dimensions are in millimeters
2. Empty component pockets sealed with top cover tape
3. The maximum number of consecutive missing LEDs is two.

Emitter Reel Packaging

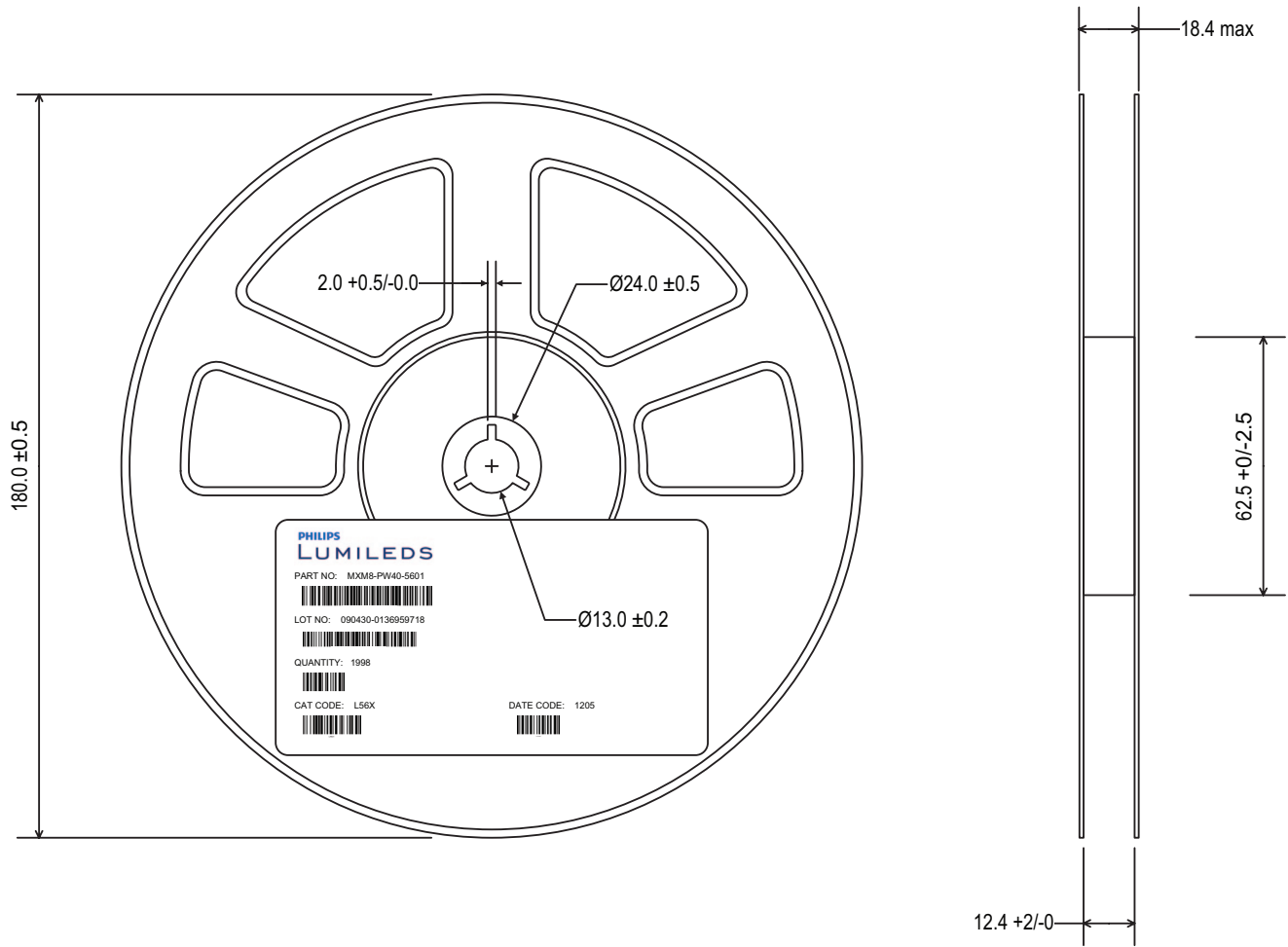

Figure 14. Emitter reel packaging.

Notes for Figure 14:

1. All dimensions are in millimeters.
2. Empty component pockets sealed with top cover tape.
3. 7 inch reel-1000 pieces per reel.
4. Minimum packing quantity is 500 pieces.
5. The maximum number of consecutive missing LEDs is two.
6. In accordance with EIA-481-I-B specification.

Product Binning and Labeling

Purpose of Product Binning

In the manufacturing of semiconductor products, there is a variation of performance around the average values given in the technical data sheets. For this reason, Philips Lumileds bins the LED components for luminous flux, color and forward voltage (V_f).

Decoding Product Bin Labeling

LUXEON Mid-Power emitters are labeled using a four digit alphanumeric code (CAT code) depicting the bin values for emitters packaged on a single reel. All emitters packaged within a reel are of the same 3-variable bin combination. Using these codes, it is possible to determine optimum mixing and matching of products for consistency in a given application.

Reels of 2700K, 3000K, 3500K, 4000K, 5000K, 5700K, 6500K emitters are labeled with a four digit alphanumeric CAT code following the format below.

ABCD

A = Flux bin (L etc.)

B and C = Color bin (For example 51, 52, 53, 54, 55, 56)

D = V_f bin

Luminous Flux Bins

Table 8 lists the standard photometric luminous flux bins for LUXEON Mid-Power emitters (tested and binned at 100 mA).

Although several bins are outlined, product availability in a particular bin varies by production run and by product performance. Not all bins are available in all colors.

Table 8. Flux Bins - All Colors

Bin Code	Minimum Photometric Flux (lm)	Maximum Photometric Flux (lm)
K	28	32
L	32	36
M	36	40
P	40	44

Tested and binned at 25°C, $I_f=100$ mA. Tester tolerance: $\pm 7\%$.

Forward Voltage Bins

Table 9. V_f Bins

Bin Code	Minimum Forward Voltage (V)	Maximum Forward Voltage (V)
T	2.8	2.9
V	2.9	3.0
W	3.0	3.1
X	3.1	3.2
Y	3.2	3.3
Z	3.3	3.4

Tested and binned at 25°C, $I_f = 100$ mA.

Color Bin Structure

MXM8-PW27-0000 Color Bin Structure

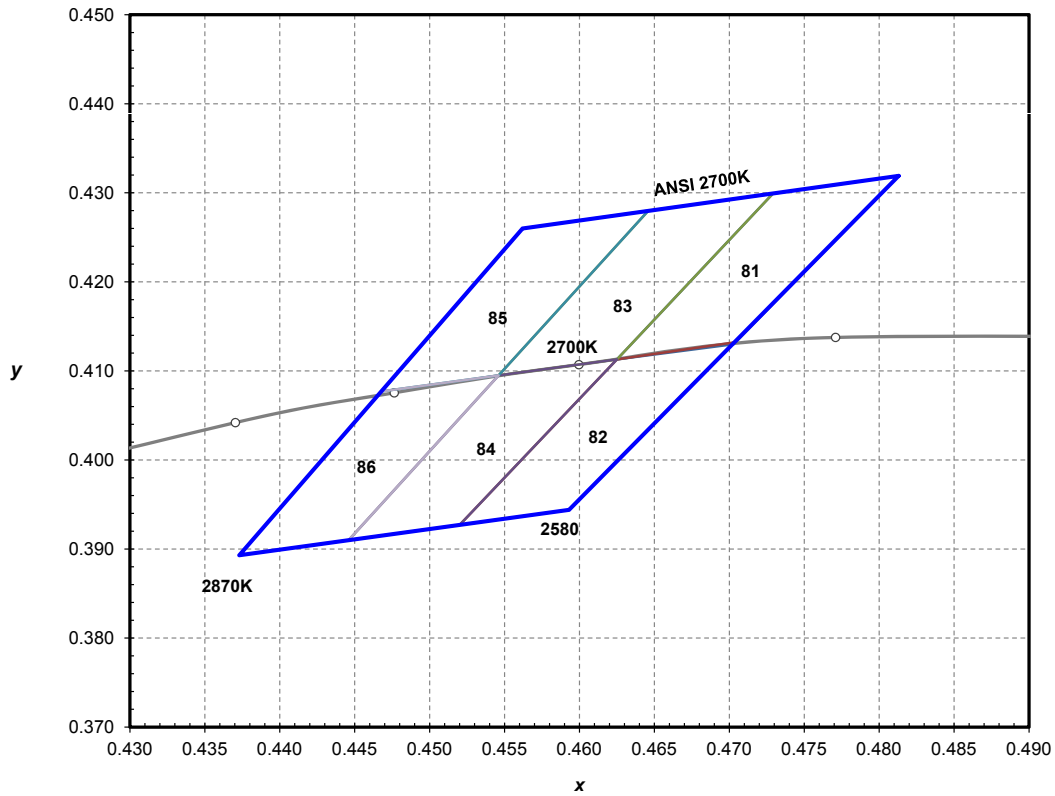

Figure 15. ANSI 2700K 1/6th color bin structure, forward current = 100 mA, thermal pad temperature = 25°C.

LUXEON Mid-Power Emitters are tested and binned by x,y coordinates.

Table 10.

LUXEON Mid-Power ANSI 1/6 Color Bin Coordinates for MXM8-PW27-0000 Emitter					
Bin Code	x	y	Bin Code	x	y
81	0.4625	0.4113	84	0.4446	0.3910
	0.4729	0.4299		0.4546	0.4095
	0.4813	0.4319		0.4625	0.4113
	0.4703	0.4130		0.4520	0.3927
82	0.4520	0.3927	85	0.4468	0.4077
	0.4625	0.4113		0.4562	0.4260
	0.4703	0.4132		0.4646	0.4280
	0.4593	0.3944		0.4546	0.4095
83	0.4546	0.4095	86	0.4373	0.3893
	0.4646	0.4280		0.4468	0.4077
	0.4729	0.4299		0.4546	0.4095
	0.4625	0.4113		0.4446	0.3910

Notes for Table 10:

I. Tester tolerance: ±0.01 in x and y coordinates.

Color Bin Structure, Continued

MXM8-PW30-0000 Color Bin Structure

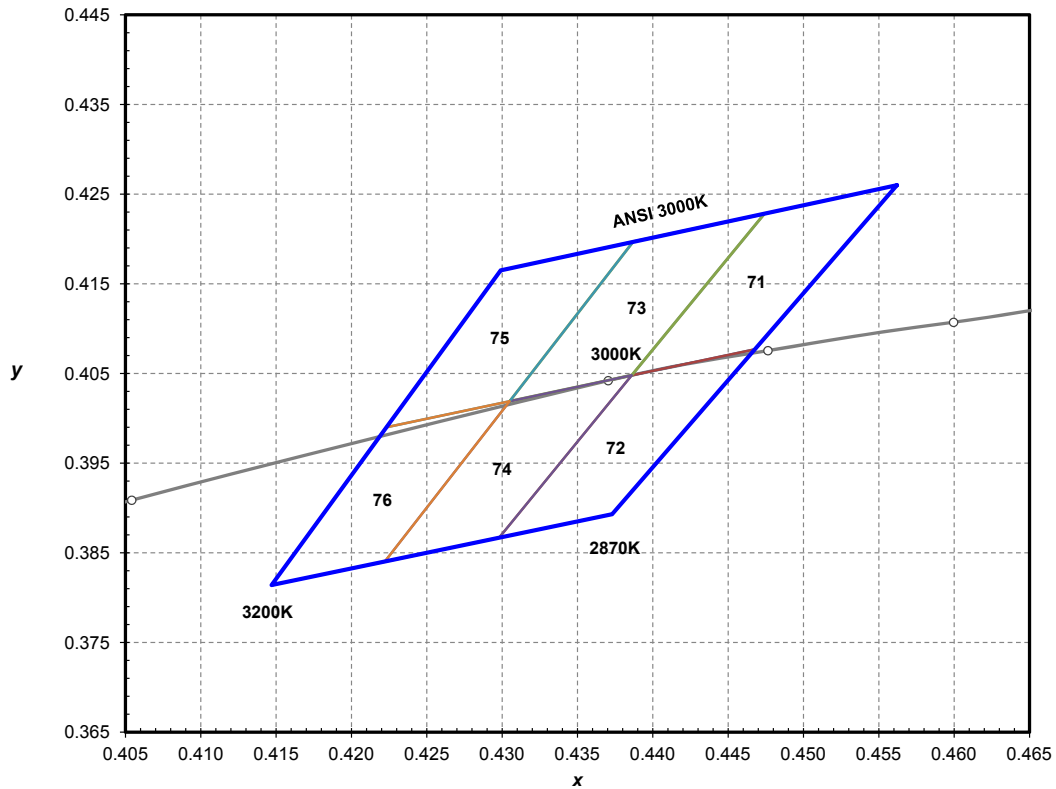

Figure 16. ANSI 3000K 1/6th color bin structure, forward current = 100 mA, thermal pad temperature = 25°C.

LUXEON Mid-Power Emitters are tested and binned by x,y coordinates.

Table II.

LUXEON Mid-Power ANSI 1/6 Color Bin Coordinates for MXM8-PW30-0000 Emitter					
Bin Code	x	y	Bin Code	x	y
71	0.4386	0.4048	74	0.4222	0.3840
	0.4474	0.4228		0.4305	0.4019
	0.4562	0.4260		0.4386	0.4048
	0.4468	0.4077		0.4298	0.3867
72	0.4298	0.3867	75	0.4223	0.3990
	0.4386	0.4048		0.4299	0.4165
	0.4468	0.4077		0.4387	0.4197
	0.4373	0.3893		0.4305	0.4019
73	0.4305	0.4019	76	0.4147	0.3814
	0.4387	0.4197		0.4223	0.3990
	0.4474	0.4228		0.4305	0.4019
	0.4386	0.4048		0.4222	0.3840

Notes for Table II:

I. Tester tolerance: ±0.01 in x and y coordinates.

Color Bin Structure, Continued

MXM8-PW35-0000 Color Bin Structure

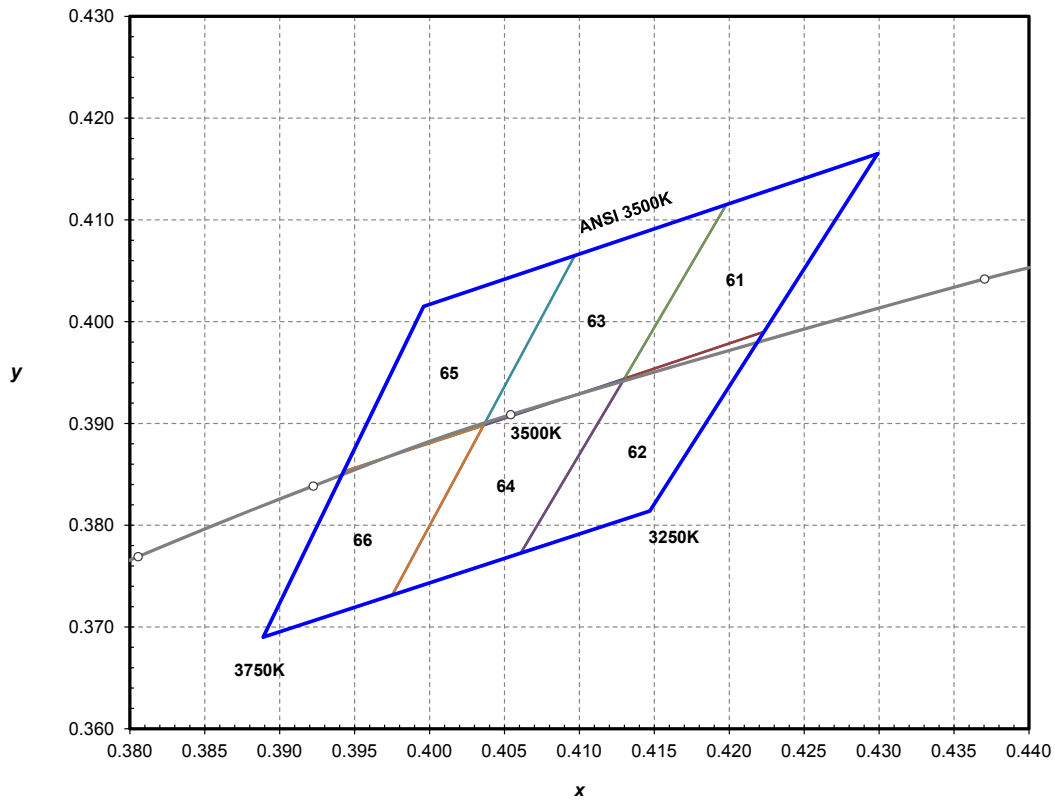

Figure 17. ANSI 3500K 1/6th color bin structure, forward current = 100 mA, thermal pad temperature = 25°C.

LUXEON Mid-Power Emitters are tested and binned by x,y coordinates.

Table 12.

LUXEON Mid-Power ANSI 1/6 Color Bin Coordinates for MXM8-PW35-0000 Emitter					
Bin Code	x	y	Bin Code	x	y
61	0.4130	0.3944	64	0.3975	0.3731
	0.4198	0.4115		0.4036	0.3898
	0.4299	0.4165		0.4130	0.3944
	0.4223	0.3990		0.4061	0.3773
62	0.4061	0.3773	65	0.3943	0.3853
	0.4130	0.3944		0.3996	0.4015
	0.4223	0.3990		0.4097	0.4065
	0.4147	0.3814		0.4036	0.3898
63	0.4036	0.3898	66	0.3889	0.3690
	0.4097	0.4065		0.3943	0.3853
	0.4198	0.4115		0.4036	0.3898
	0.4130	0.3944		0.3975	0.3731

Notes for Table 12:

I. Tester tolerance: ±0.01 in x and y coordinates.

Color Bin Structure, Continued

MXM7-PW40-0000 Color Bin Structure

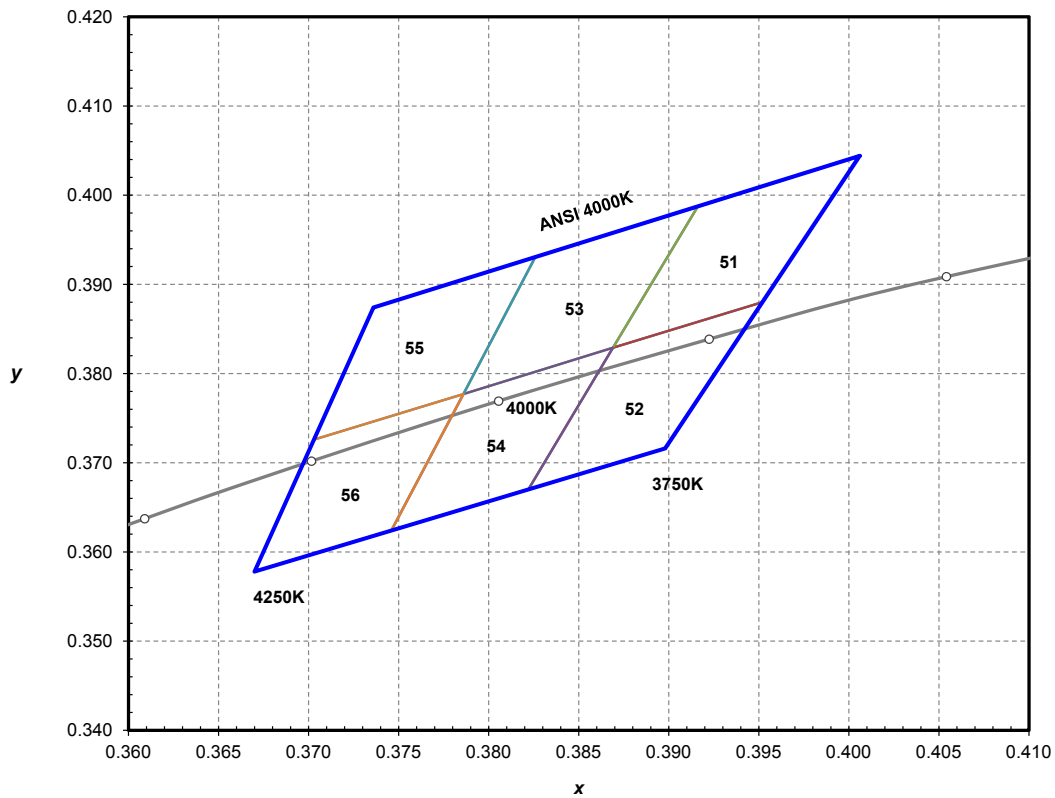

Figure 18. ANSI 4000K 1/6th color bin structure, forward current = 100 mA, thermal pad temperature = 25°C.

LUXEON Mid-Power Emitters are tested and binned by x,y coordinates.

Table 13.

LUXEON Mid-Power ANSI 1/6 Color Bin Coordinates for MXM7-PW40-0000 Emitter					
Bin Code	x	y	Bin Code	x	y
51	0.3869	0.3829	54	0.3746	0.3624
	0.3916	0.3987		0.3786	0.3777
	0.4006	0.4044		0.3869	0.3829
	0.3952	0.3880		0.3822	0.3670
52	0.3822	0.3670	55	0.3703	0.3726
	0.3869	0.3829		0.3736	0.3874
	0.3952	0.3880		0.3826	0.3931
	0.3898	0.3716		0.3786	0.3777
53	0.3786	0.3777	56	0.3670	0.3578
	0.3826	0.3931		0.3703	0.3726
	0.3916	0.3987		0.3786	0.3777
	0.3869	0.3829		0.3746	0.3624

Notes for Table 13:

I. Tester tolerance: ±0.01 in x and y coordinates.

Color Bin Structure, Continued

MXM7-PW50-0000 Color Bin Structure

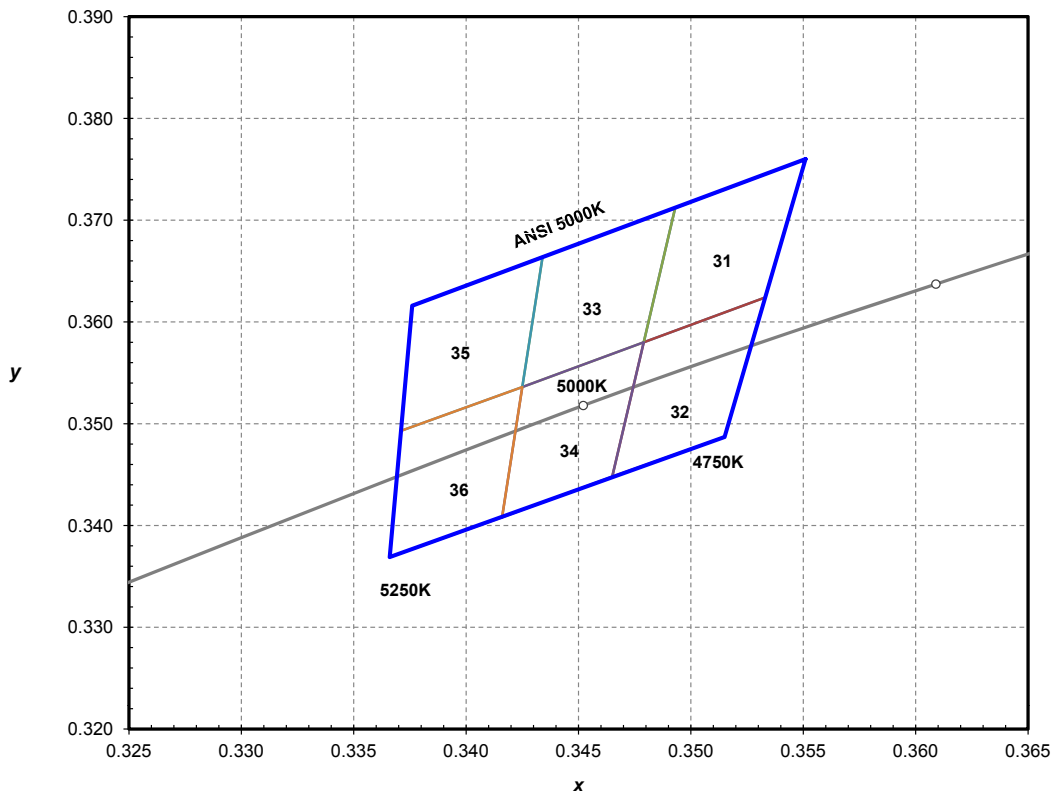

Figure 19. ANSI 5000K 1/6th color bin structure, forward current = 100 mA, thermal pad temperature = 25°C.

LUXEON Mid-Power Emitters are tested and binned by x,y coordinates.

Table 14.

LUXEON Mid-Power ANSI 1/6 Color Bin Coordinates for MXM7-PW50-0000 Emitter					
Bin Code	x	y	Bin Code	x	y
31	0.3479	0.3580	34	0.3416	0.3408
	0.3493	0.3712		0.3425	0.3536
	0.3551	0.3760		0.3479	0.3580
	0.3533	0.3624		0.3465	0.3448
32	0.3465	0.3448	35	0.3371	0.3493
	0.3479	0.3580		0.3376	0.3616
	0.3533	0.3624		0.3434	0.3664
	0.3515	0.3487		0.3425	0.3536
33	0.3425	0.3536	36	0.3366	0.3369
	0.3434	0.3664		0.3371	0.3493
	0.3493	0.3712		0.3425	0.3536
	0.3479	0.3580		0.3416	0.3408

Notes for Table 14:

I. Tester tolerance: ±0.01 in x and y coordinates.

Color Bin Structure, Continued

MXM7-PW57-0000 Color Bin Structure

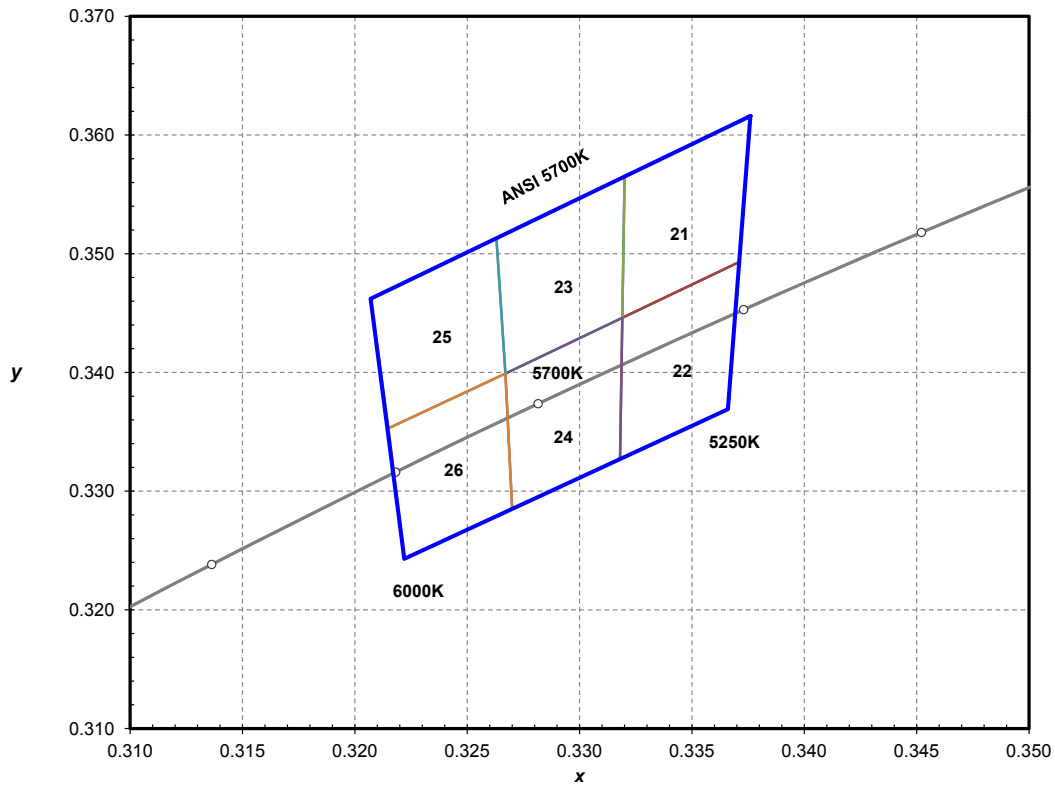

Figure 20. ANSI 5700K 1/6th color bin structure, forward current = 100 mA, thermal pad temperature = 25°C.

LUXEON Mid-Power Emitters are tested and binned by x,y coordinates.

Table 15.

LUXEON Mid-Power ANSI 1/6 Color Bin Coordinates for MXM7-PW57-0000 Emitter					
Bin Code	x	y	Bin Code	x	y
21	0.3319	0.3446	24	0.3270	0.3285
	0.3320	0.3565		0.3267	0.3399
	0.3376	0.3616		0.3319	0.3446
	0.3371	0.3493		0.3318	0.3327
22	0.3318	0.3327	25	0.3215	0.3353
	0.3319	0.3446		0.3207	0.3462
	0.3371	0.3493		0.3263	0.3513
	0.3366	0.3369		0.3267	0.3399
23	0.3267	0.3399	26	0.3222	0.3243
	0.3263	0.3513		0.3215	0.3353
	0.3320	0.3565		0.3267	0.3399
	0.3319	0.3446		0.3270	0.3285

Notes for Table 15:

I. Tester tolerance: ±0.01 in x and y coordinates.

Color Bin Structure, Continued

MXM7-PW65-0000 Color Bin Structure

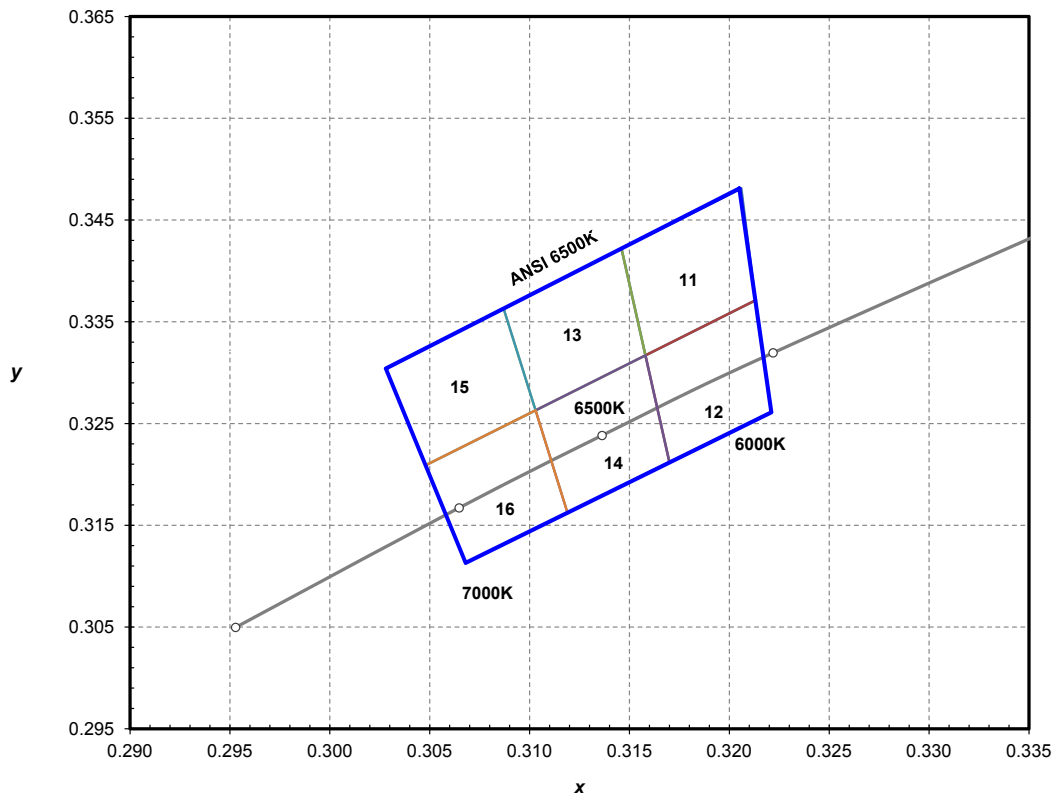

Figure 21. ANSI 6500K 1/6th color bin structure, forward current = 100 mA, thermal pad temperature = 25°C.

LUXEON Mid-Power Emitters are tested and binned by x,y coordinates.

Table 16.

LUXEON Mid-Power ANSI 1/6 Color Bin Coordinates for MXM7-PW65-0000 Emitter					
Bin Code	x	y	Bin Code	x	y
11	0.3158	0.3317	14	0.3119	0.3162
	0.3146	0.3422		0.3103	0.3263
	0.3206	0.3481		0.3158	0.3317
	0.3213	0.3371		0.3170	0.3212
12	0.3170	0.3212	15	0.3048	0.3209
	0.3158	0.3317		0.3028	0.3304
	0.3213	0.3371		0.3087	0.3363
	0.3221	0.3261		0.3103	0.3263
13	0.3103	0.3263	16	0.3068	0.3113
	0.3087	0.3363		0.3048	0.3209
	0.3146	0.3422		0.3103	0.3263
	0.3158	0.3317		0.3119	0.3162

Notes for Table 16:

I. Tester tolerance: ±0.01 in x and y coordinates.

Company Information

Philips Lumileds is a leading provider of LEDs for everyday lighting applications. The company's records for light output, efficacy and thermal management are direct results of the ongoing commitment to advancing solid-state lighting technology and enabling lighting solutions that are more environmentally friendly, help reduce CO₂ emissions and reduce the need for power plant expansion. Philips Lumileds LUXEON® LEDs are enabling never before possible applications in outdoor lighting, shop lighting, home lighting, digital imaging, display and automotive lighting.

Philips Lumileds is a fully integrated supplier, producing core LED material in all three base colors, (Red, Green, Blue) and white. Philips Lumileds has R&D centers in San Jose, California and in the Netherlands, and production capabilities in San Jose, Singapore and Penang, Malaysia. Founded in 1999, Philips Lumileds is the high flux LED technology leader and is dedicated to bridging the gap between solid-state technology and the lighting world. More information about the company's LUXEON LED products and solid-state lighting technologies can be found at www.philipslumileds.com.

Philips Lumileds Lighting Company shall not be liable for any kind of loss of data or any other damages, direct, indirect or consequential, resulting from the use of the provided information and data. Although Philips Lumileds Lighting Company has attempted to provide the most accurate information and data, the materials and services information and data are provided "as is" and Philips Lumileds Lighting Company neither warranties, nor guarantees the contents and correctness of the provided information and data. Philips Lumileds Lighting Company reserves the right to make changes without notice. You as user agree to this disclaimer and user agreement with the download or use of the provided materials, information and data.



©2013 Philips Lumileds Lighting Company. All rights reserved.
LUXEON is a registered trademark of the Philips Lumileds Lighting Company in the United States and other countries.

www.philipslumileds.com
www.philipslumileds.cn.com

LUXEON 3535 Datasheet DS202 20130228

X-ON Electronics

Largest Supplier of Electrical and Electronic Components

Click to view similar products for [High Power LEDs - White category:](#)

Click to view products by [Lumileds manufacturer:](#)

Other Similar products are found below :

[G42180-08](#) [B42180-08](#) [STW8Q2PA-R5-HA](#) [SZ5-M1-W0-00-V3/W2-AA](#) [LTPL-P00DWS57](#) [LZP-D0WW00-0000](#) [SZ5-M1-WW-C8-V1/V3-FA](#) [BXRC-27E2000-D-73](#) [BXRC-27G2000-D-73](#) [BXRC-30E1000-D-73](#) [BXRC-30G2000-D-73](#) [BXRC-40E1000-D-73](#) [BXRE-30G2000-B-73](#) [BXRE-30G2000-C-73](#) [BXRE-50C2001-C-74](#) [CXM-22-27-80-54-AC30-F4-3](#) [XHP50B-00-0000-0D0UH245G](#) [MP-5050-8100-27-80](#) [MP-5050-6100-65-80](#) [MP-5050-6100-50-80](#) [MP-5050-6100-40-80](#) [MP-5050-6100-30-80](#) [CXM-22-30-80-54-AC30-F4-3](#) [LTW-2835SZK57](#) [BXEM-50C0000-0-000](#) [WW-WNA30TS-U1\(M1\)](#) [KW CSLPM2.CC-8L8M-4L8N](#) [KW CSLPM2.CC-8L8M-4O9Q](#) [KW DPLS32.SB-6H6J-E5P7-EG-Z264](#) [L1V1-507003V500000](#) [CXM-22-35-80-36-AC10-F3-3](#) [KW3 CGLNM1.TG-Z6QF6-EBVFFCBB46-DFGA](#) [CXM-22-35-90-54-AC40-F5-3](#) [CXM-22-35-80-54-AC40-F5-3](#) [OSM51206E1N-0.8T](#) [OSW43020C1C](#) [MP161611032290](#) [MP-1616-2103-50-90](#) [KW CULPM1.TG-Z6RF7-ebvFfcbB46-65G5](#) [KW DMLS33.SG-Z6M7-EBVFFCBB46-8E8G-700-S](#) [CXM-32-35-80-54-AC40-F5-3](#) [XPGDWT-B1-0000-00EEA](#) [XHP70B-00-0000-0D0BP450E](#) [KW DMLN33.SG-7J7K-EBVFFCBB46-8E8G-200-S](#) [ASMT-MW05-NMNS1](#) [ASMT-MW06-NMNZ1](#) [KW DPLS33.KD-HIJG-D30D144-HN-22C2-120-S](#) [JR5050AWT-Q-B40EB0000-N0000001](#) [JR5050AWT-Q-H35EH0000-N0000001](#) [JR5050AWT-Q-U30EH0000-N0000001](#)