

CBT-120

Monolithic Die Series

Ultraviolet Chip On Board LEDs

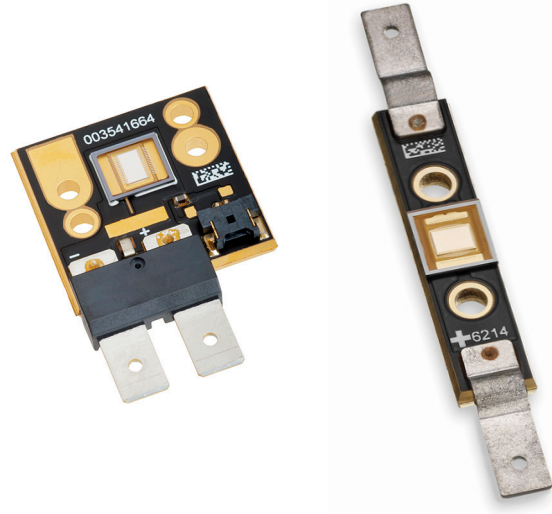

Table of Contents

Technology Overview2

Ordering Information3

Binning Structure4

Optical & Electrical Characteristics5

Optical & Electrical Characteristics Graphs.6

Typical Spectrum7

Reliability.....8

Thermal Resistance9

Mechanical Dimensions
Slim Package (C14) 10

Mechanical Dimensions
Square Package (C31) 11

Shipping Tray Slim Package (C14) 12

Shipping Tray Square Package (C31) 13

Packaging Specifications . 14

Revision History..... 15

Features:

- High thermal conductivity package .
 - › Junction to heat sink thermal resistance of < 1 °C/W
- UV LED technology for very high power density and uniform emission
- Large, monolithic chip with surface emitting area of 12 mm², 16:9 aspect ratio
- Low-profile window for efficient coupling into small-étendue systems
- High radiometric efficiency
- Environmentally friendly: RoHS compliant, mercury-free
- Variable drive currents up to 30A
- NIST traceable optical and electrical measurement testing

Applications

- Curing:
 - › Inks
 - › Coatings
 - › Adhesives
- Inspection
- Machine Vision
- Fiber-coupled illumination
- Specialty Projection Systems for Maskless Lithography:
 - › Optically matched to TI 0.65” and 0.95” DMD chipsets
- Rapid Prototyping and 3D printing
- Medical and Scientific Instrumentation

Technology Overview

Luminus LEDs benefit from innovations in device technology, chip packaging and thermal management. This suite of technologies give engineers and system designers the freedom to develop solutions both high in power and efficiency.

Luminus Technology

Luminus' technology enables large area LED chips to emit photons uniformly over the entire LED chip surface. The intense optical power density produced by these UV LEDs facilitate designs which replace arc and halogen lamps where arrays of traditional high power LEDs cannot.

For UV devices, Luminus engineers the LEDs to maximize light extraction and to emit with a Lambertian far-field distribution pattern. The design maximizes efficiency and allows for flexible optical designs.

Packaging Technology

Thermal management is critical in high power LED applications. Luminus CBT-120-UV LEDs have the lowest thermal resistance of any LED on the market with a thermal resistance from junction to heat sink of 0.73°C/W or 0.88°C/W. This allows the LED to be driven at higher current densities while maintaining a low junction temperature, thereby resulting in brighter solutions and longer lifetimes.

Reliability

Designed from the ground up, Luminus LEDs are one of the most reliable light sources in the world today. Luminus LEDs have passed a rigorous suite of environmental and mechanical stress tests, including mechanical shock, vibration, temperature cycling and humidity, and have been fully qualified for use in extreme high power and high current applications. With very low failure rates and median lifetimes that typically exceed 10,000 hours, Luminus LEDs are ready for even the most demanding applications.

Environmental Benefits

Luminus LEDs help reduce power consumption and the amount of hazardous waste entering the environment. All LED products manufactured by Luminus are RoHS compliant and free of hazardous materials, including lead and mercury.

Understanding Luminus LED Test Specifications

Every Luminus LED is fully tested to ensure that it meets the high quality standards expected from Luminus' products.

Testing Temperature

Luminus core board products are typically measured in such a way that the characteristics reported agree with how the devices will actually perform when incorporated into a system. This measurement is accomplished by mounting the devices on a 40°C heat sink and measuring the device while fully powered. This method of measurement ensures that Luminus LEDs perform in the field just as they are specified.

Multiple Operating Points

The tables on the following pages provide typical optical and electrical characteristics for the standard drive conditions. Since the LEDs can be operated over a wide range of drive conditions (currents from <1A to 30 A, and duty cycle from <1% to 100%) there are many other potential values attainable. Driving devices beyond recommended driving conditions shortens lifetime (see derating curves on page 6).

Ordering Information

Part Number Nomenclature

CBT — 120 — CC — C## — FF###-2#

Product Family	Chip Area	Color	Package Configuration	Bin Kit ^{1,2,3}
CBT: Copper-core PCB, Monolithic Die	120: 12 mm ²	UV = Ultraviolet	C14: 44.5 mm x 10 mm - Slim Package C31: 28 mm x 26.75 mm - Square Package See Mechanical Drawing section	See below for bin definition table

Note 1: A Bin Kit represents a group of individual flux or power bins that are shippable for a given ordering part number. Individual flux bins are not orderable.

Note 2: Flux Bin listed is minimum bin shipped - higher bins may be included at Luminus' discretion

CBT-120-UV Bin Kit Order Codes

The following tables describe the bin kit ordering codes for the CBT-120-UV. The power and wavelength bins included in the bin kit. Each kit specifies a minimum power and the listed wavelength. A maximum power is not specified. Within each kit, Luminus may ship any part meeting or exceeding the minimum power specification. Shipments will always meet the listed wavelength bin's range. For information on ordering bin kits not listed below, please contact Luminus or an official distributor.

Products	Ordering Part Number	Description
CBT-120-UV	CBT-120-UV-C31-x123-22	CBT-120-UV consisting of a 12 mm ² LED, a thermistor, connectors, and a square copper-core PCB.
	CBT-120-UV-C14-x123-22	CBT-120-UV consisting of a 12 mm ² LED, connectors, and a slim (rectangular) copper-core PCB.

Color	Bin Kit Code	Power (W)	Wavelength (nm)	
		Minimum Allowed	Min.	Max.
UV	N400-22	14.6	400	410
	P400-22	16.1	400	410
	Q400-22	17.7	400	410

CBT-120-UV Binning Structure

CBT-120-UV LEDs are specified for luminous flux and chromaticity/wavelength at a drive current of 18 A (1.5 A/mm²) and placed into one of the following Power Bins and Wavelength Bins:

Power Bins

Color	Power Flux Bin (F)	Minimum Flux (W)	Maximum Flux (W)
UV	N	14.6	16.1
	P	16.1	17.7
	Q	17.7	19.5

*Note: Luminus maintains a +/- 6% tolerance on power measurements.

Wavelength Bins

Color	Wavelength Bin (123)	Minimum Wavelength (nm)	Maximum Wavelength (nm)
UV	400	400	405
	405	405	410

Reference Optical & Electrical Characteristics ($T_{hs} = 40^{\circ}\text{C}$)^{1,2}

UV			
Parameter	Symbol	Values	Unit
Drive Condition³		18 A	
Current Density	j	1.5	A/mm ²
Forward Voltage	V_{Fmin}	3.2	V
	V_F	3.4	V
	V_{Fmax}	4.3	V
Radiometric Flux ⁵	Φ_{typ}	18.0	W
Radiometric Flux Density	Φ_R	1.5	W/mm ²
Wavelength Range	λ	400 - 410	nm
Peak Wavelength	λ_p	405	nm

	Symbol	UV	Unit
Emitting Area		12.0	mm ²
Emitting Area Dimensions		4.63 × 2.6	mm × mm
Dynamic Resistance	Ω_{dyn}	0.02	Ω

Absolute Maximum Ratings

	Symbol	UV	Unit
Minimum Current ⁶		0.2	A
Maximum Current ⁶		30	A
Maximum Junction Temperature ⁷	T_{jmax}	150	°C
Storage Temperature Range		-40 to +100	°C

Note 1: Data verified using NIST traceable calibration standard.

Note 2: All data are based on test conditions with a constant heat sink temperature $T_{hs} = 40^{\circ}\text{C}$ under pulse testing conditions. Pulse conditions: 25% duty-cycle and frequency of 360 Hz. Nominal $T_j \approx 80^{\circ}\text{C}$. See Thermal Resistance section for T_j and T_{hs} definition.

Note 3: Listed drive conditions are typical for common applications. CBT-120-UV devices can be driven at currents ranging from 0.2 A to 30 A and at duty cycles ranging from 1% to 100%. Drive current and duty cycle should be adjusted as necessary to maintain the junction temperature desired to meet application lifetime requirements.

Note 4: Unless otherwise noted, values listed are typical. Devices are production tested and specified at 18 A.

Note 5: Typical total flux from emitting area at listed peak wavelength. Reported performance is included to show trends for a selected power level. For specific minimum and maximum values, use bin tables. For product roadmap and future performance of devices, contact Luminus.

Note 6: CBT-120-UV LEDs are designed for operation to an absolute maximum current as specified above. Product lifetime data is specified at recommended forward drive currents. Sustained operation at or beyond absolute maximum currents will result in a reduction of device life time compared to recommended forward drive currents. Actual device lifetimes will also depend on junction temperature. Refer to the lifetime derating curves for further information. In pulsed operation, rise time from 10-90% of forward current should be longer than 0.5 $\mu\text{seconds}$.

Note 7: Lifetime dependent on LED junction temperature. Input power and thermal system must be properly managed to ensure lifetime. See charts on page 5 for further information.

Note 8: Special design considerations must be observed for operation under 1 A. Please contact Luminus for further information.

Optical & Electrical Characteristics

Relative Power vs Forward Current, $T_j = 80^\circ\text{C}$

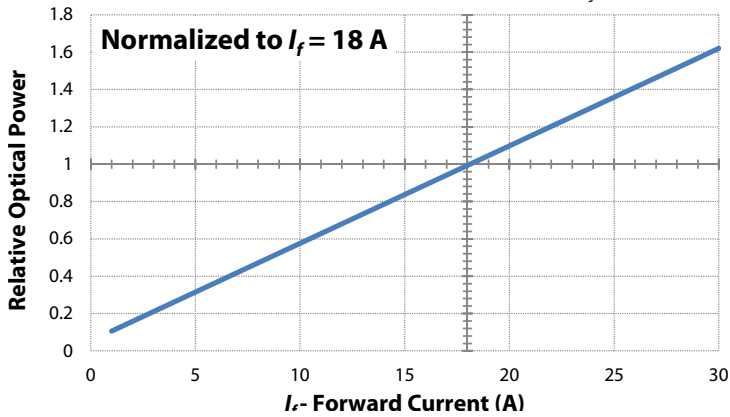

Relative Power vs Junc. Temperature, $I_f = 18\text{ A}$

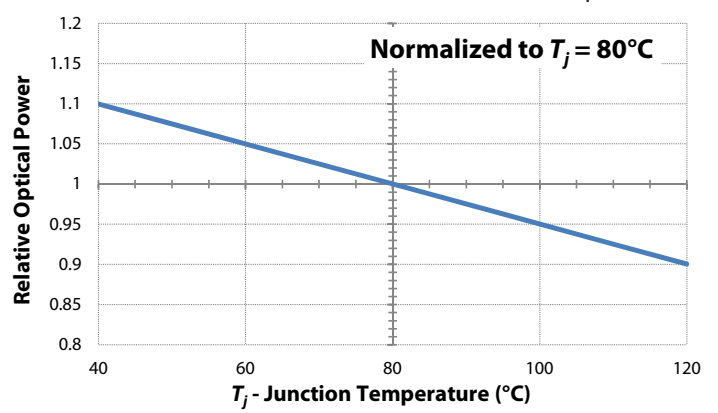

Peak Wavelength vs Forward Current

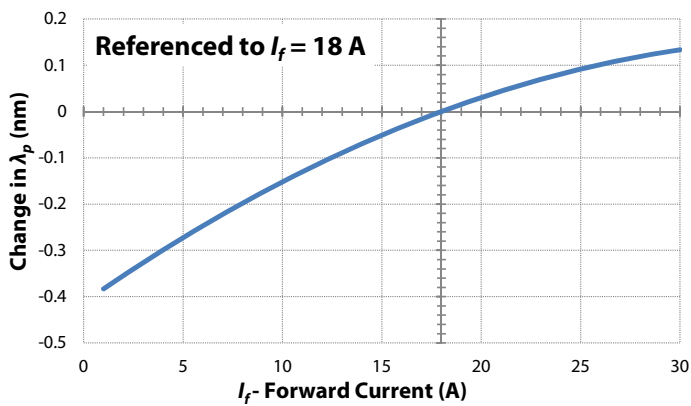

Peak Wavelength vs Junction Temperature

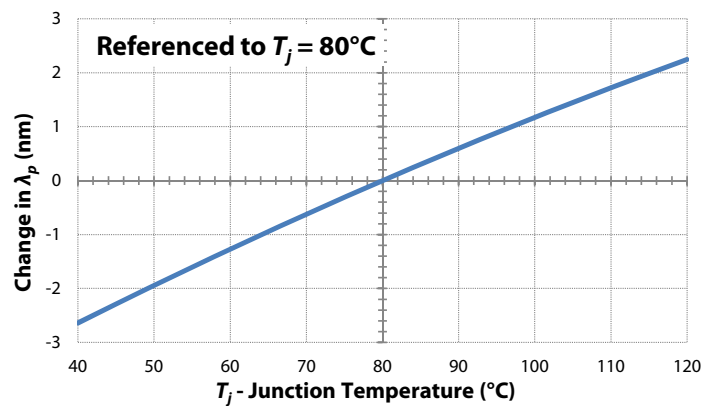

Forward Voltage vs Forward Current

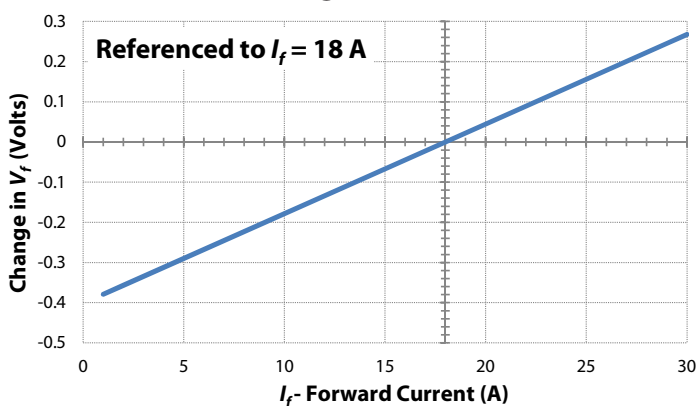

Forward Voltage vs Junction Temperature

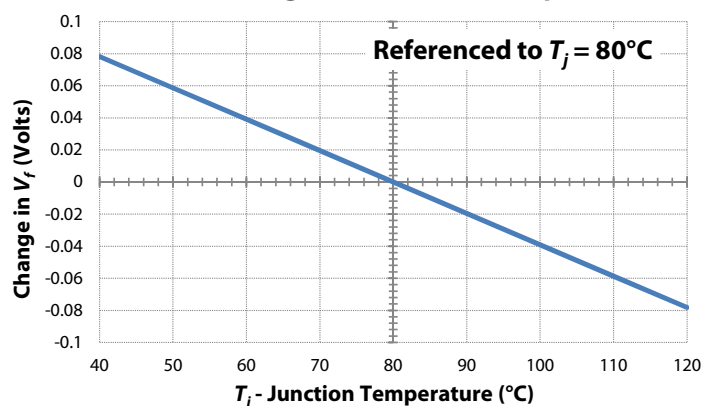

Typical Radiation Pattern

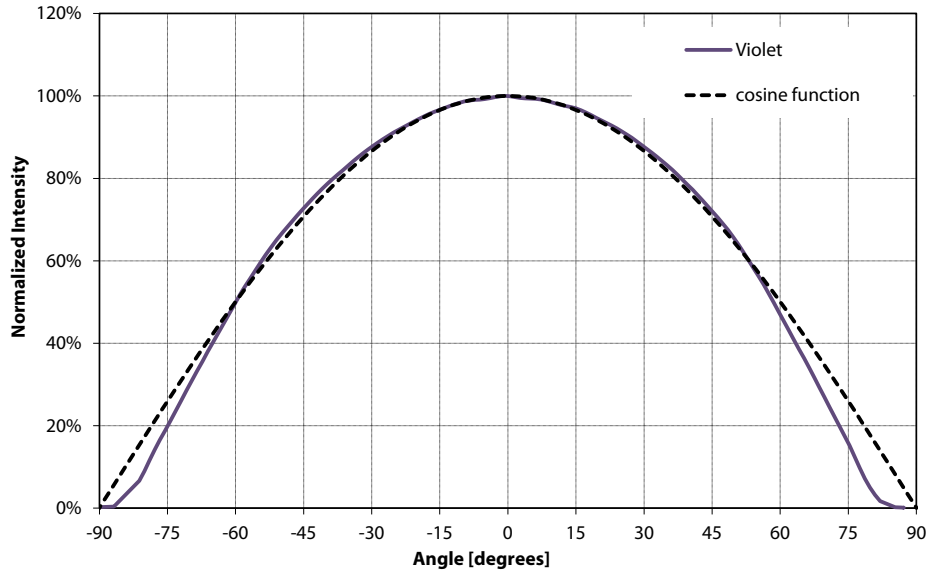

Typical Spectrum⁹

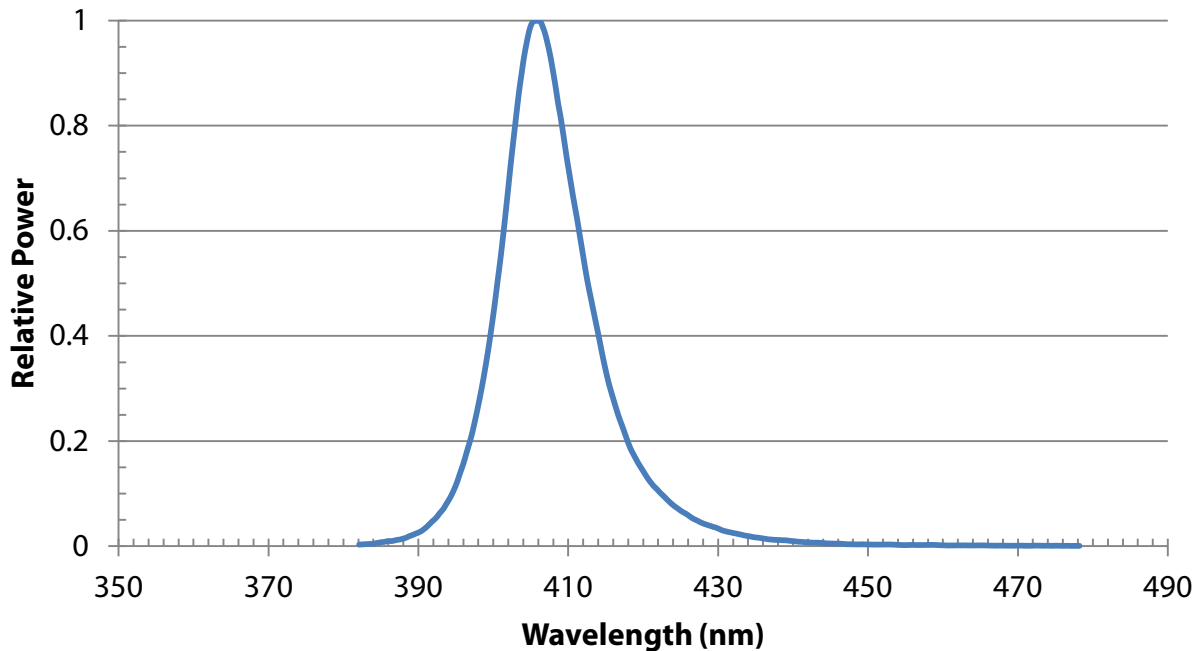

Note 9. Typical spectrum at current of 18 A in continuous operation.

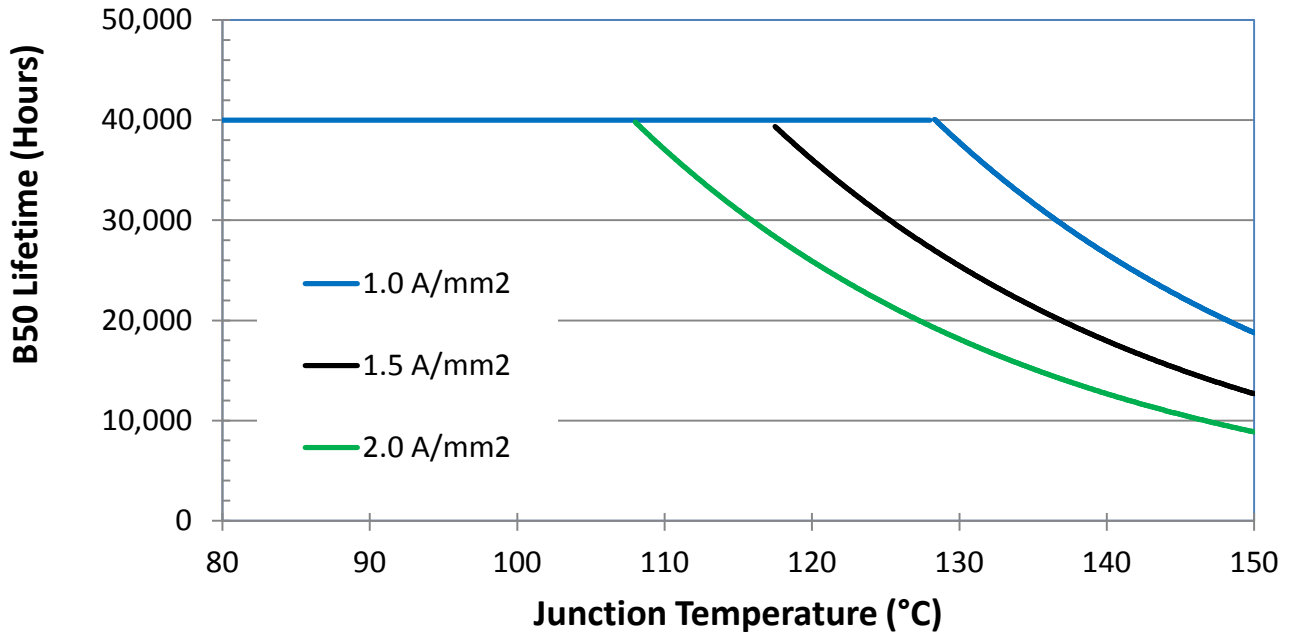
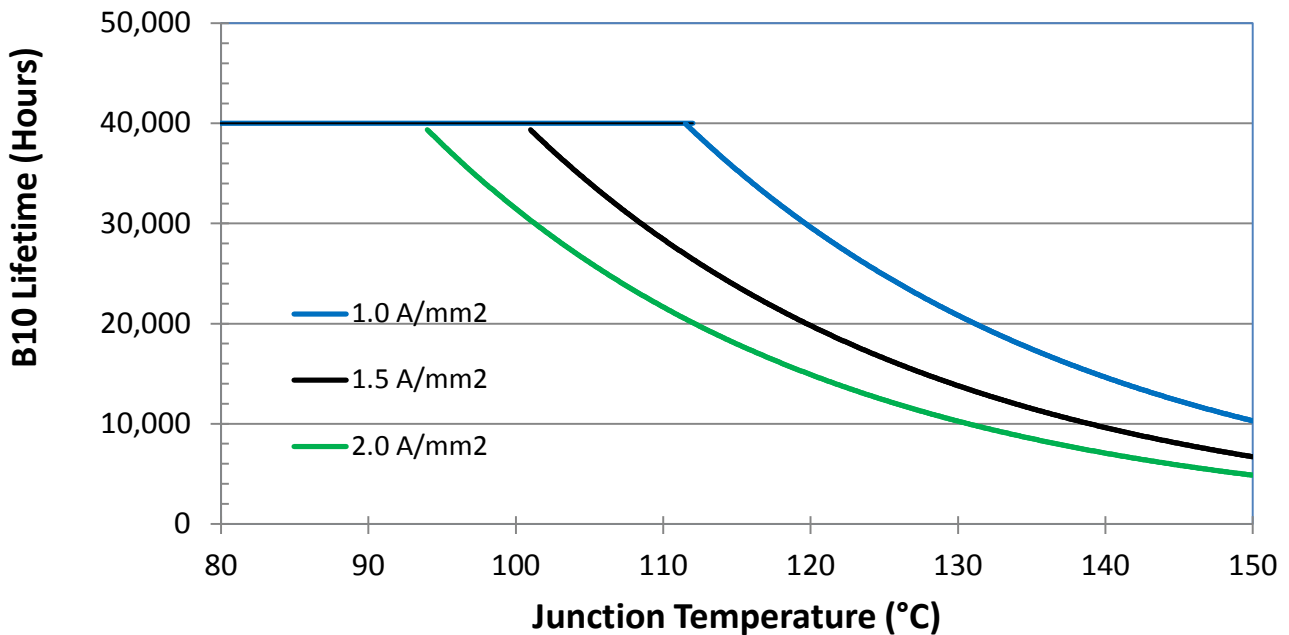
CBT-120-UV Reliability¹⁰
CBTxx-UV-405nm B50 Lifetime

CBTxx-UV-405nm B10 Lifetime

Note 10. Lifetime defined as time to 70% of initial intensity. Data can be used to model failure rate over typical product lifetime.

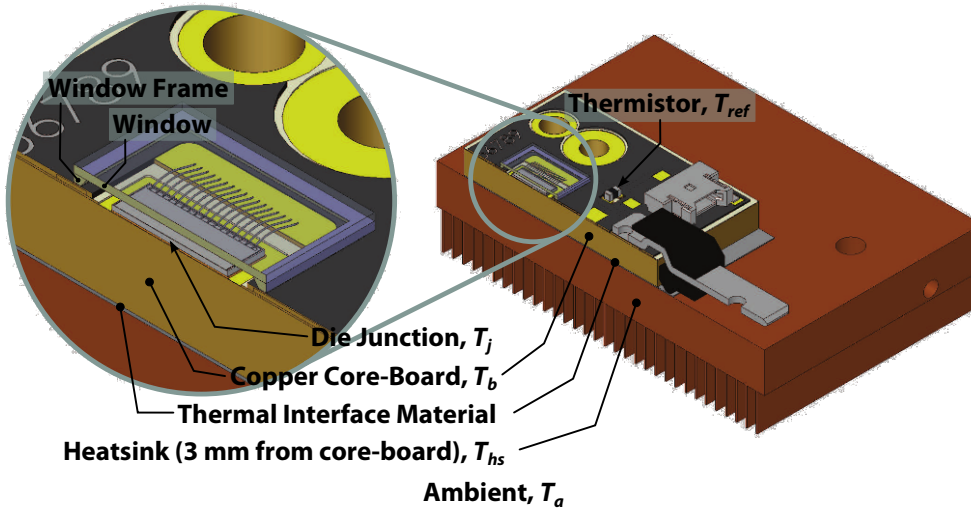
Thermal Resistance CBT-120-UV-C31



Typical Thermal Resistance

$R_{\theta j-b}^1$	0.61 °C/W
$R_{\theta b-hs}^1$	0.12 °C/W
$R_{\theta j-hs}^2$	0.73 °C/W
$R_{\theta j-ref}^1$	0.64 °C/W

Note 1: Thermal resistance values are based on FEA model results correlated to measured $R_{\theta j-hs}$ data.

Note 2: Thermal Resistance is based on eGraf 1205 Thermal interface.

Thermal Resistance CBT-120-UV-C14

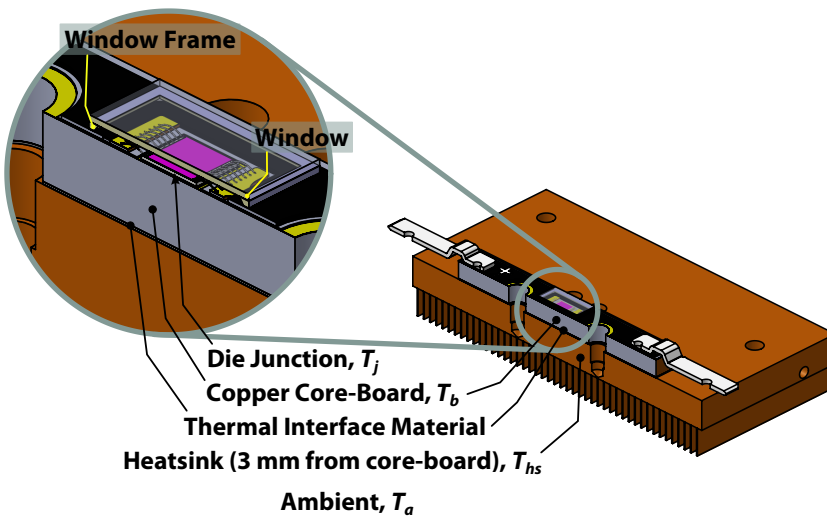

Typical Thermal Resistance

$R_{\theta j-b}^1$	0.76 °C/W
$R_{\theta b-hs}^1$	0.12 °C/W
$R_{\theta j-hs}^2$	0.88 °C/W

Note 1: Thermal resistance values are based on FEA model results correlated to measured $R_{\theta j-hs}$ data.

Note 2: Thermal Resistance is based on Fujipoly Thermal interface.

Electrical Pinout - C31 Package

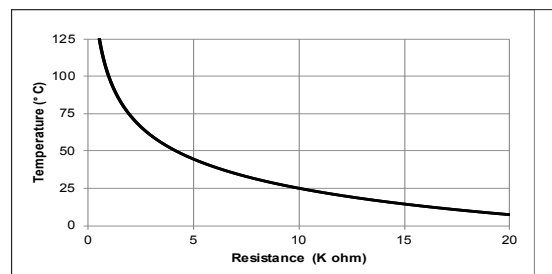
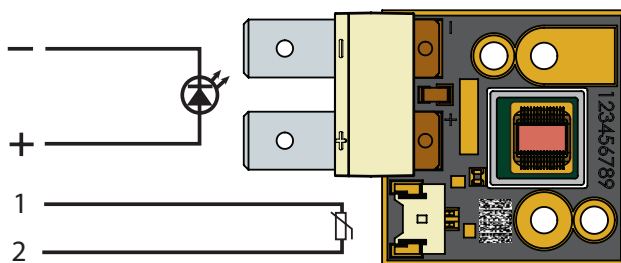

The thermistor used in CBT-120 devices mounted on coreboards is from Murata Manufacturing Co. The global part number is NCP18XH103J03RB. Please see <http://www.murata.com/> for details on calculating thermistor temperature.

For more information on use of the thermistor, please contact Luminus directly.

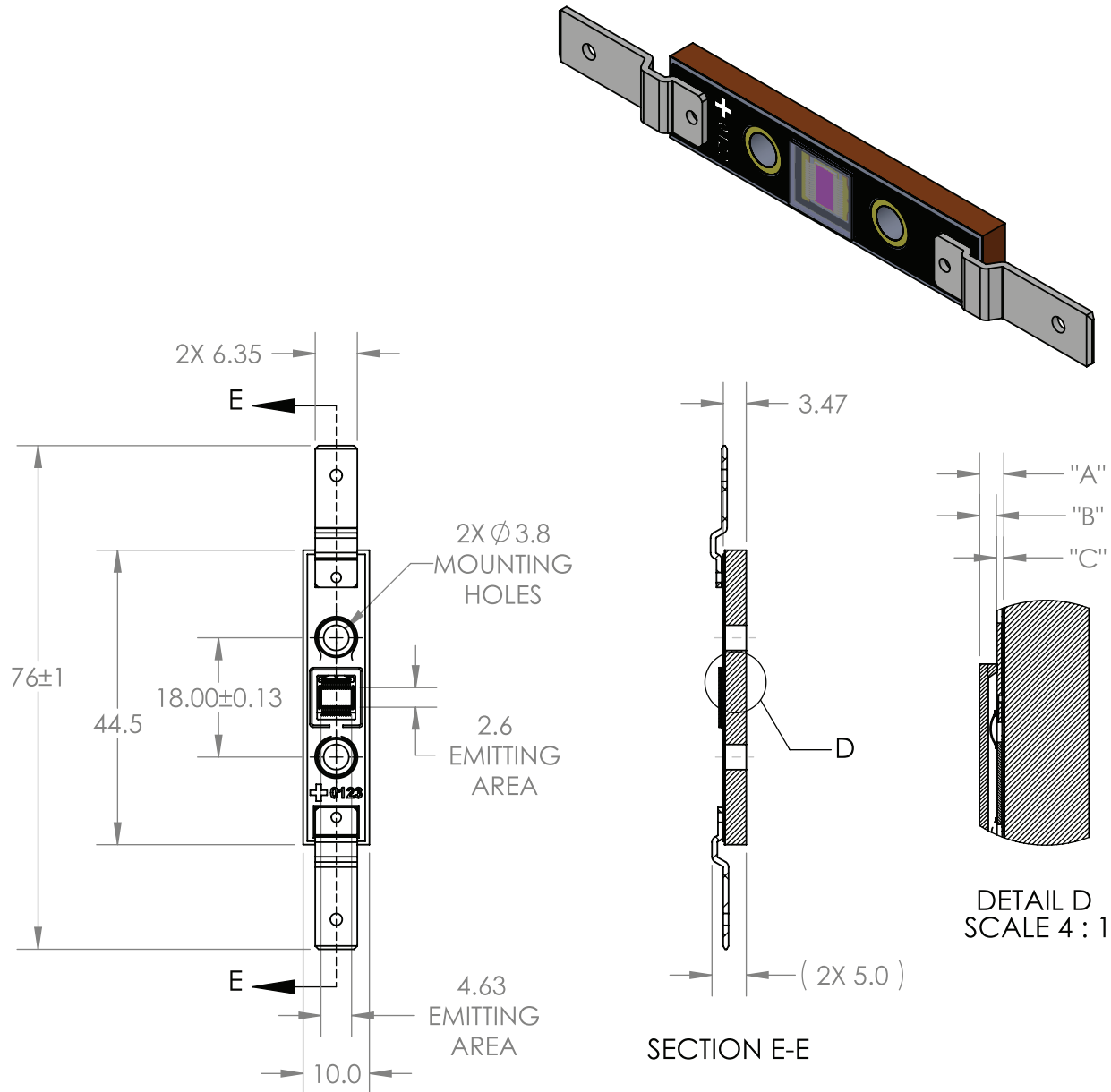
Mechanical Dimensions – CBT-120-UV-C14 Emitter

DIMENSIONS IN MILLIMETERS

DIMENSION NAME	DESCRIPTION	NOMINAL DIMENSION	TOLERANCE
"A"	TOP OF METAL SUBSTRATE TO TOP OF GLASS	0.93	±0.07
"B"	TOP OF EMITTING AREA TO TOP OF GLASS	0.64	±0.07
"C"	TOP OF METAL SUBSTRATE TO EMITTING AREA	0.29	±0.05

Recommended connector for Anode and Cathode: Panduit Disco Lok™ Series P/N: DNG14-250FL-C.

DWG-001898

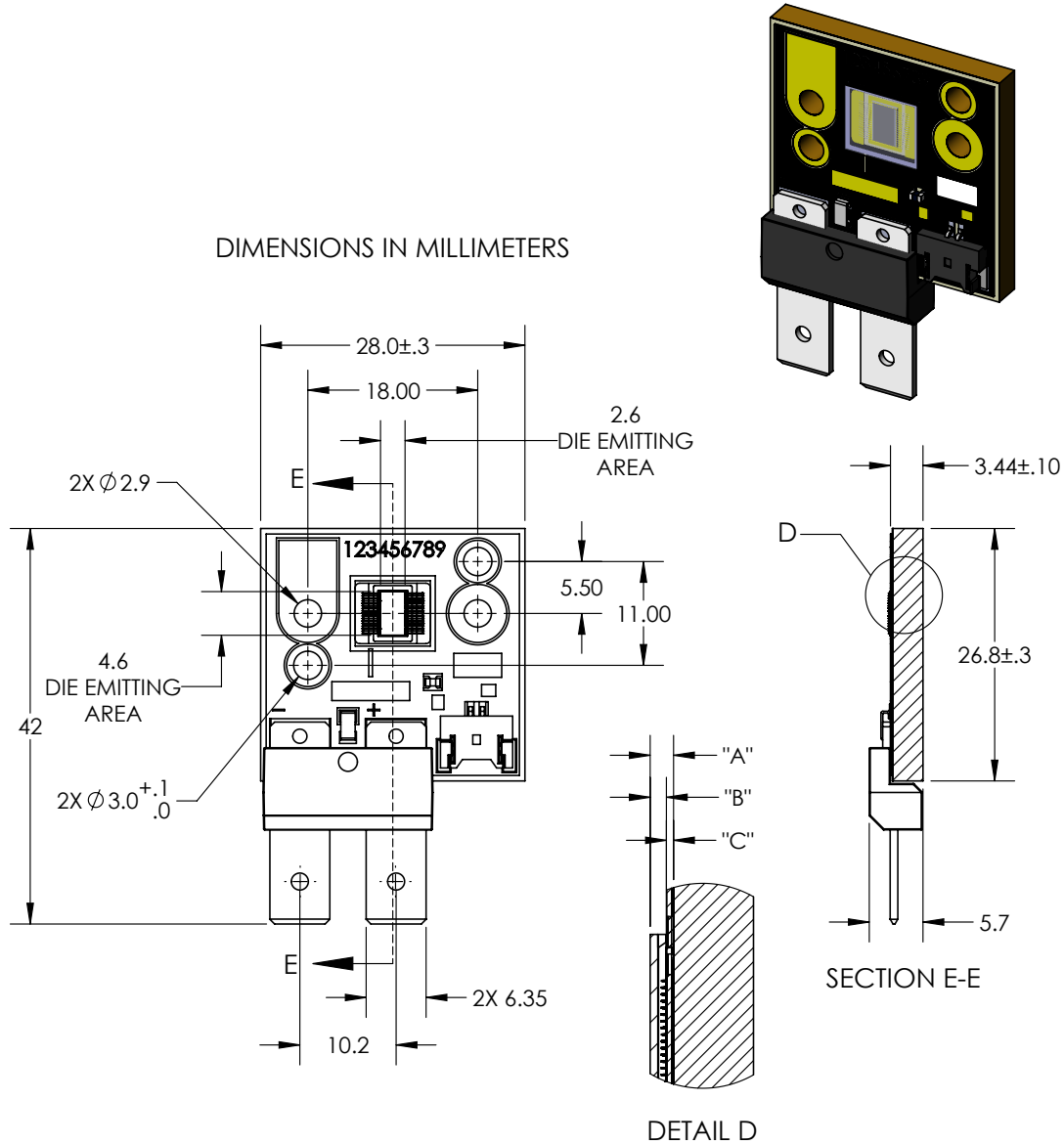
Mechanical Dimensions – CBT-120-UV-C31 Emitter

DIMENSION NAME	DESCRIPTION	NOMINAL DIMENSION	TOLERANCE
"A"	TOP OF METAL SUBSTRATE TO TOP OF WINDOW	0.91	±0.13
"B"	TOP OF DIE EMITTING AREA TO TOP OF WINDOW	0.61	±0.11
"C"	TOP OF METAL SUBSTRATE TO TOP OF DIE EMITTING AREA	0.27	±0.02

DWG-002179

Recommended connector for Anode and Cathode: Panduit Disco Lok™ Series P/N: DNG14-250FL-C.
 Thermistor Connector: MOLEX P/N 53780-0270 or GCT P/N WTB08-021S-F.
 Recommended Female: MOLEX P/N 51146-0200, GCT P/N WTB06-021S-F or equivalent

Shipping Tray Outline - CBT-120-C14

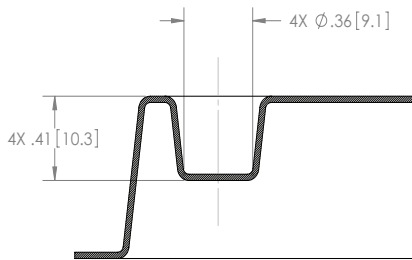
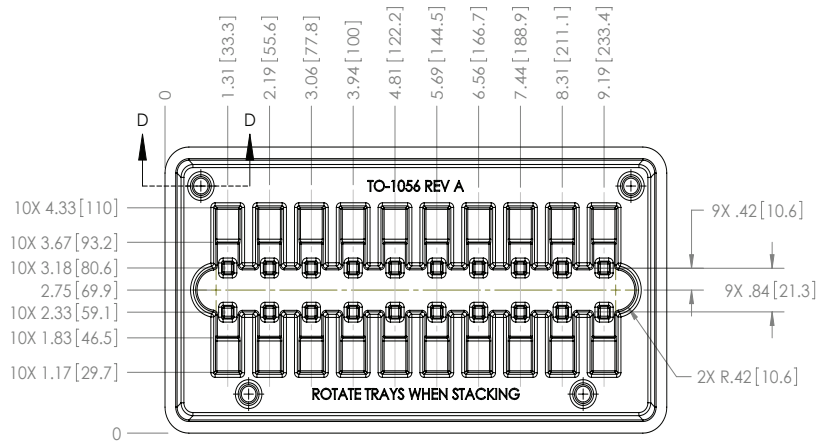

SECTION D-D
SCALE 2:1

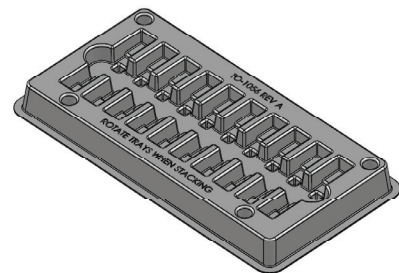

Shipping Tray Outline - CBT-120-C31

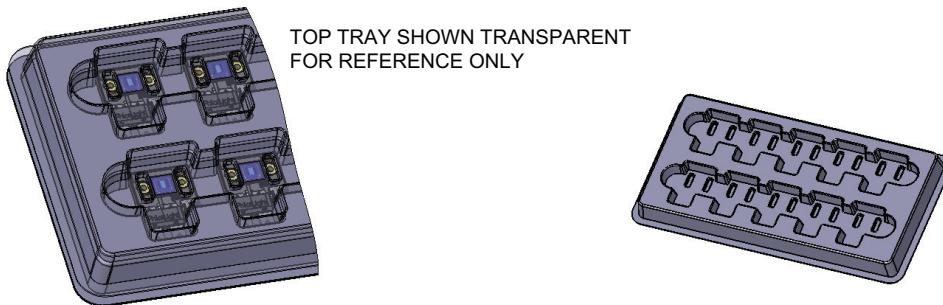
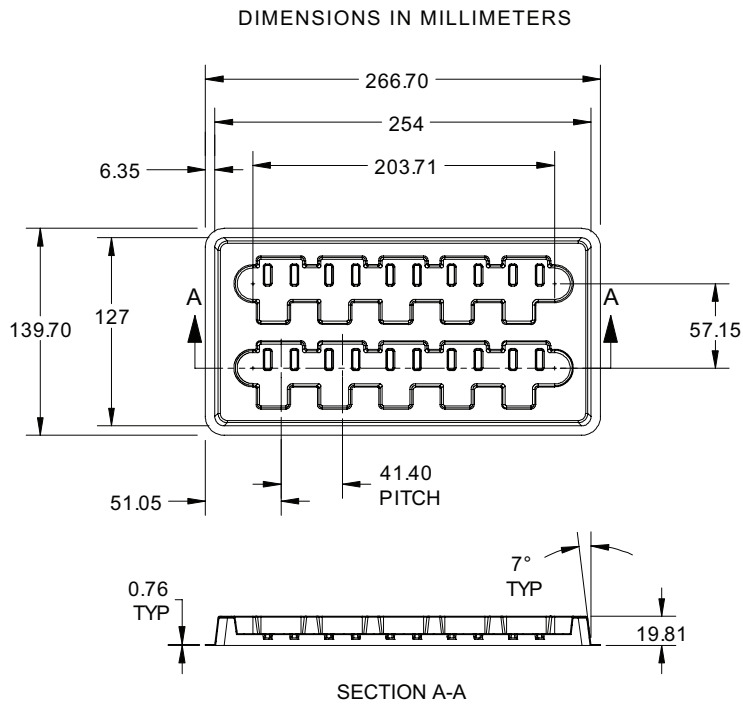

Packing and Shipping Specification (CBT-120)

Packing Specification

Packing Configuration	Qty /Pack	Box Dimensions (diameter x W, mm)	Gross Weight (kg)
Stack of 5 trays with 10 devices per tray Each pack is enclosed in ESD bag	50	140 x 280 x 70	2.7

Product Label Specification

Label Fields (subject to change):

- 6-8 digit Box number (for Luminus internal use)
- Luminus ordering part number
- Quantity of devices in pack
- Part number revision (for Luminus internal use)
- Customer's part number (optional)
- Flux Bin
- 2D Bar code





LUMINUS
LEADER IN BIG CHIP LEDS Solid State Filament™

BT-012345

Box number

PT-120-G-L11-MPG

Luminus part number

12345678

Customer part number

5F

Bin

Qty: 50

Rev 01



for traceability peel off label and attach

RoHS Compliant

Sample label –for illustration only

Shipping Box

Shipping Box	Quantity	Material	Dimensions (L x W x H, mm)
Carton Box	1 -20 packs (50 - 1000 Devices)	S4651	560 x 560 x 200



History of Changes

Rev	Date	Description of Change
01	03/20/2013	Initial Release
02	10/19/2013	Editorial Changes
03	02/06/2013	Updated Performance
04	03/21/2013	Added C14 Package Specs
05	04/18/2013	Updated Performance
06	08/09/2013	Implemented New Window Design
07	09/10/2014	Updated Performance
08	08/05/2015	Discontinued 385nm Parts, Updated format to combine with PDS-002172
09	10/05/2015	Updated Performance
10	03/29/2016	Updated Binning and Reliability



The products, their specifications and other information appearing in this document are subject to change by Luminus Devices without notice. Luminus Devices assumes no liability for errors that may appear in this document, and no liability otherwise arising from the application or use of the product or information contained herein. None of the information provided herein should be considered to be a representation of the fitness or suitability of the product for any particular application or as any other form of warranty. Luminus Devices' product warranties are limited to only such warranties as accompany a purchase contract or purchase order for such products. Nothing herein is to be construed as constituting an additional warranty. No information contained in this publication may be considered as a waiver by Luminus Devices of any intellectual property rights that Luminus Devices may have in such information. Big Chip LEDs™ is a registered trademark of Luminus Devices, Inc., all rights reserved.

This product is protected by U.S. Patents 6,831,302; 7,074,631; 7,083,993; 7,084,434; 7,098,589; 7,105,861; 7,138,666; 7,166,870; 7,166,871; 7,170,100; 7,196,354; 7,211,831; 7,262,550; 7,274,043; 7,301,271; 7,341,880; 7,344,903; 7,345,416; 7,348,603; 7,388,233; 7,391,059 Patents Pending in the U.S. and other countries.

X-ON Electronics

Largest Supplier of Electrical and Electronic Components

Click to view similar products for [LED Lighting Modules](#) category:

Click to view products by [Luminus Devices](#) manufacturer:

Other Similar products are found below :

[CDM-14-3018-90-36-DW01](#) [LPS1-01C24-4070-00](#) [XHP50A-0L-02-0D0BH430E](#) [28085](#) [LMH020-0850-27G9-00000SS](#) [LMH020-0850-27G9-00001SS](#) [LMH020-1250-27G9-00001SS](#) [LMH020-2000-27G9-00001SS](#) [LMH020-3000-27G9-00000SS](#) [LMH020-6000-30G9-00001TW](#) [LMH020-6000-40G9-00001TW](#) [LMH020-8000-30G9-00001TW](#) [LMH020-8000-40G9-00001TW](#) [LMH02B-1250-30G9-00000TW](#) [LMH02B-3000-35G9-00001TW](#) [LMH02B-3000-40G9-00001TW](#) [LMR020-0650-35F9-20100TW](#) [LLT-3R](#) [Z-G4-15WW](#) [ZM-1610-CW](#) [ZM-189-CW](#) [ZM-6223-CW](#) [ZRS-8480-CW](#) [ZRS-8480-WW](#) [L218-3080024C30000](#) [L218-3080048C00000](#) [L218-3580024C30000](#) [L218-3580048C00000](#) [L218-4080024C30000](#) [L218-4090024C30000](#) [L218-4090048C00000](#) [L218-5080024C30000](#) [L2M0-4070003MC3300](#) [L2M0-4070004MC2200](#) [L2M0-5070003MC3300](#) [L2M0-5770005MC3300](#) [CBM-120-FR-C15-RA100](#) [CBM-120-UV-C31-K380-21](#) [CBM-120-UV-X31-I365-22](#) [CBM-120-UV-X31-L400-22](#) [CBM-90-IRD-X33-K850](#) [CBT-120-G-C11-JK200](#) [CBT-140-WCS-L16-UA120](#) [CBT-140-WCS-L16-UA122](#) [CBT-140-WCS-L16-UA123](#) [CBT-140-WDH-L16-QB220](#) [CBT-140-WDH-L16-RA220](#) [CBT-90-B-L11-G100](#) [CBT-90-B-L11-H101](#) [CBT-90-B-L11-J101](#)