

Generation 2

Dispense

CCT Tunable LED COBs

PRELIMINARY

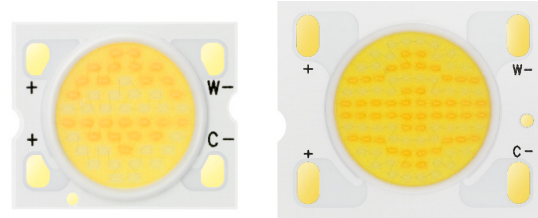

Table of Contents

Test Specifications2

Dimensions and Graphs....4

Optical and Electrical Character-
istics.....5

Package Dimensions7

Shipping Container8

Handling Notes9

Features:

- Two channel cool and warm 90+ CRI LEDs
- 95 CRI typical with both channels powered on
- High lumen density for directional lighting
- Enables system beam angles from 10 to 40 degrees
- 6500K to 2700K CCT range for commercial and residential lighting
- Robust design standard COB manufacturing materials and processes
- Consistent white light <3 SDCM
- Specified “hot” performance and 100% factory tested at Tj=85°C
- Environmentally friendly: RoHS and REACH compliant
- UL recognized, file # E465703



Applications

- Human centric lighting
- Hospitality / hotel / restaurant lighting
- Residential lighting
- Museum and high-end retail lighting
- Circadian lighting in hospitals, offices, or schools

Products Families

- CTM-9-6527-90-36-TWD2: Typical 8.4W per channel, 9.3mm LES
- CTM-14-6527-90-36-TWD2: Typical 25W per channel, 13.7mm LES
 - 6527: CCT range (“4018” = 4000K to 1800K)
 - 90: minimum CRI
 - “36” = 36V nominal voltage
 - TWD2 = standard configuration

Technology Data

Electrical data @ $T_j=85^\circ\text{C}$

Part number	Nominal forward current per channel	Nominal input power per channel	Nominal voltage per channel	Maximum voltage per channel	Maximum forward current per channel	Maximum forward power per channel
CTM-9-6527-90-36-TWD2	250mA	8.25W	33V	37V	450mA	17W
CTM-14-6527-90-36-TWD2	700mA	23W	33V	37V	900mA	34W

* Note that the maximum current and maximum power per channel also serve as guidelines for maximum current and maximum power for both channels combined. Luminaire thermal system capability and power derating curves on page 6 must be considered, and most 2 channel drivers will limit or should limit the combined maximum forward current of both channels per the values in the table above. In order to drive both channels simultaneously above nominal current, the luminaire's thermal system must be appropriately engineered to dissipate the thermal load and avoid absolute maximum case temperatures and junction temperatures.

Photometric Data @ $T_j=85^\circ\text{C}$ and Nominal Forward Current:

Part number	CRI (min)	CCT of cool white	Minimum flux (lumens)	Nominal flux (lumens)	CCT of warm white	Minimum flux (lumens)	Nominal flux (lumens)
CTM-9-6527-90-36-TWD2	90	6500K	940	1100	2700K	900	940
CTM-14-6527-90-36-TWD2	90	6500K	3260	3500	2700K	2550	3040

Chromaticity Bins and Ellipse Definitions @ $T_j=85^\circ\text{C}$:

Nominal CCT	Center Point		Angle	3-step bin	
	CIEx	CIEy	$\theta(^{\circ})$	a	b
2700K	0.4579	0.4115	54.39	0.00964	0.00421
6500K	0.3125	0.3280	65.10	0.00995	0.00348

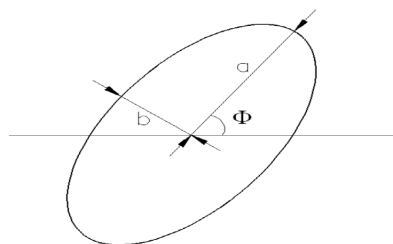

CTM Gen2 Current Ratios and Nominal CCTs

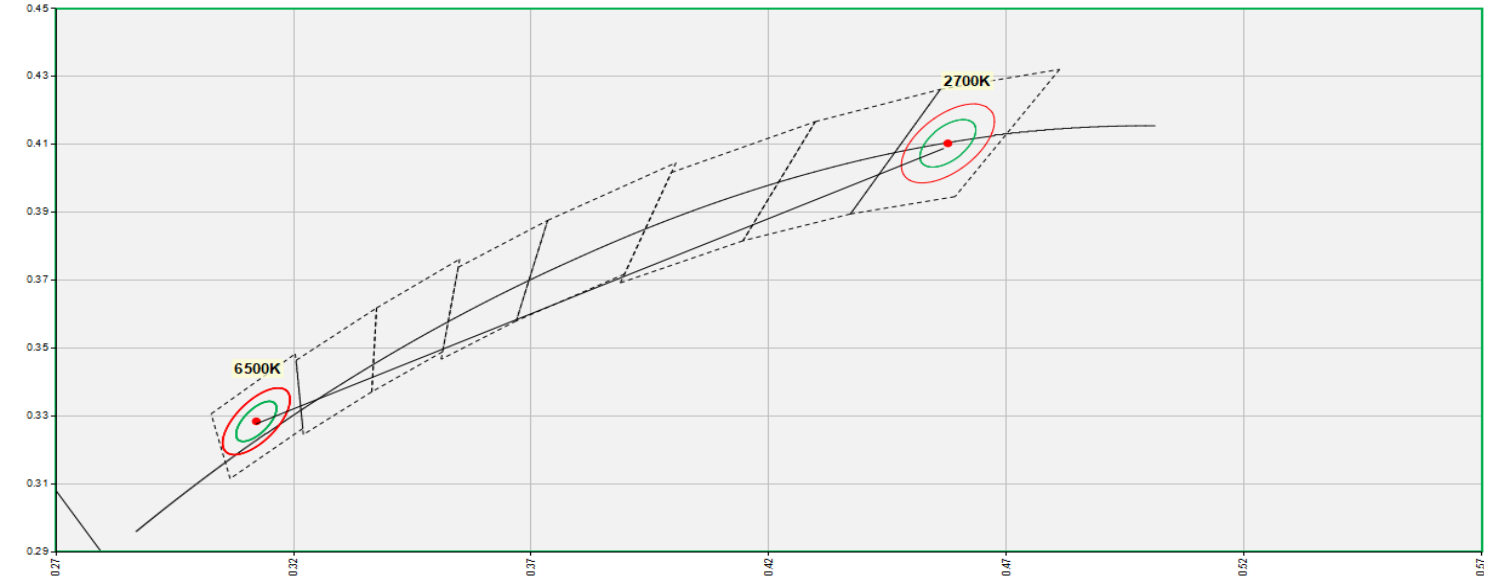

Absolute Maximum Ratings & Optical/Electrical Characteristics:

Parameter	Symbol	Minimum	Typical	Maximum	Unit
Operating case temperature	T_c			105	°C
Junction temperature	T_j			125	°C
Viewing angle	$2(\Theta_{1/2})$		130		Degrees
Reverse voltage	V_r			5	Volts
Ambient operating temperature	T_{opr}	-40		+85	°C
Storage temperature	T_{sto}	-40		+85	°C
Electrostatic Discharge	ESD			4000V	HBM

Mechanical Dimensions & Thermal Resistance:

Part Number	Light Emitting Surface (LES) Diameter	Board Size	Typical Thermal Resistance (Rthj-c)	PCB Thickness
CTM-9-6527-90-36-TWD1	9.3mm	12x15mm	0.5 K/W	1mm
CTM-14-6527-90-36-TWD1	13.7mm	20x24mm	0.25 K/W	1mm

Relative Output Flux vs. Junction Temperature

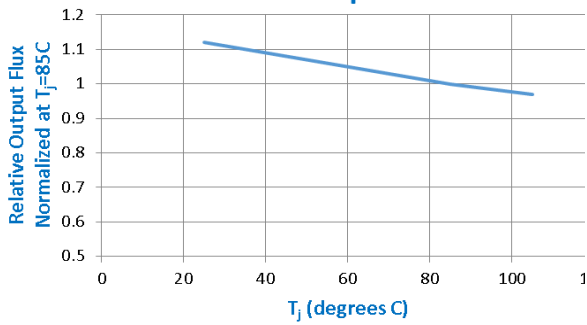

CTM-9(each channel)High CCT@Tj=85°C Forward Current vs. Forward Voltage

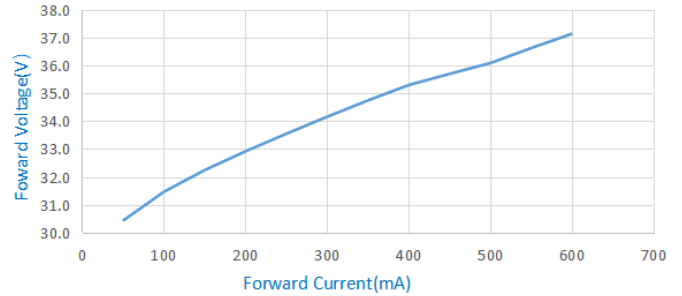

CTM-9(each channel)Low CCT@Tj=85°C Forward Current vs. Forward Voltage

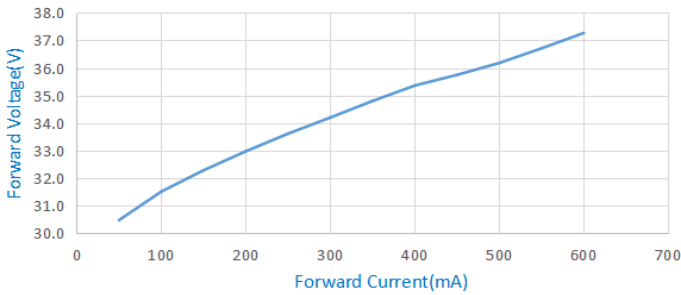

CTM-9 High CCT Relative Luminus Flux vs. Forward Current per Channel

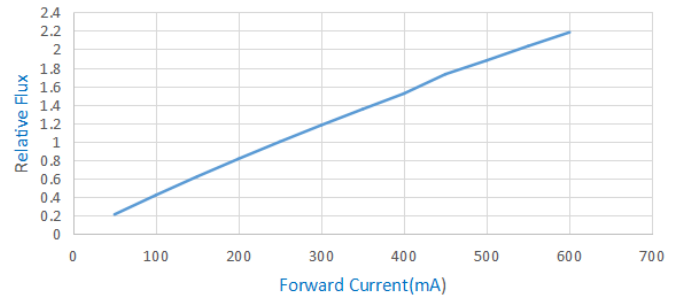

CTM-9 Low CCT Relative Luminus Flux vs. Forward Current per Channel

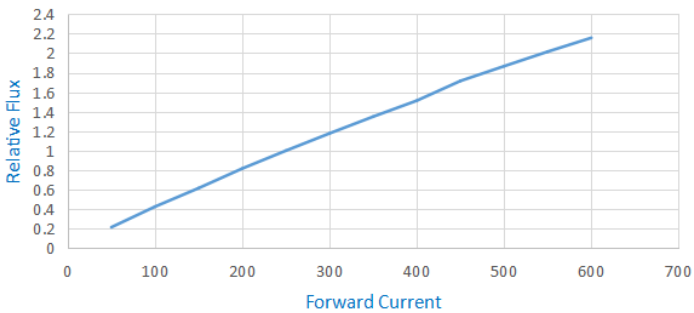

CTM-14 Low CCT Relative Luminus Flux vs. Forward Current per Channel

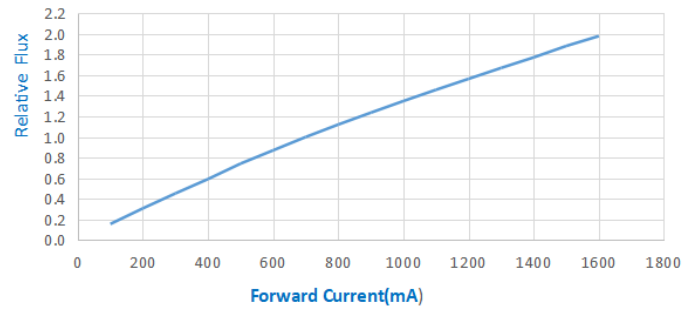

CTM-14 High CCT Relative Luminus Flux vs. Forward Current per Channel

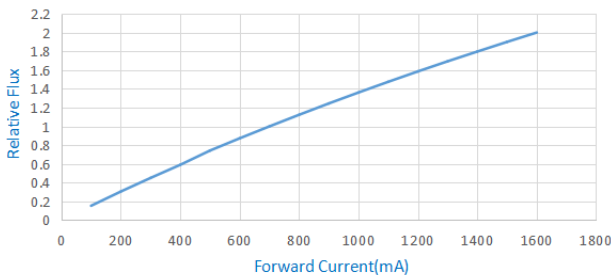

CTM-14(each channel)Low CCT@Tj=85°C Forward Current vs. Forward Voltage

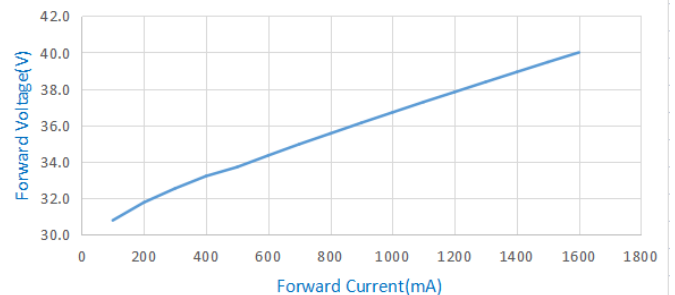

CTM-14(each channel)High CCT@Tj=85°C
 Forward Current vs. Forward Voltage

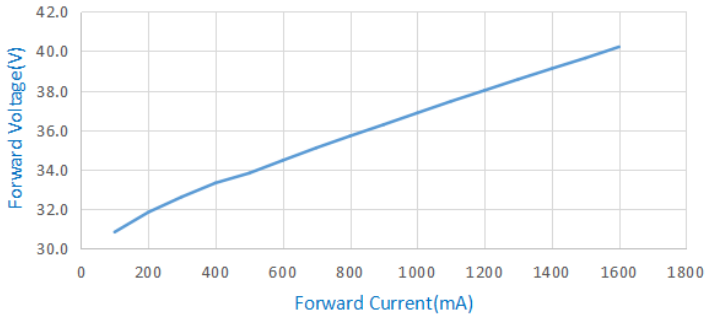

CTM-14 Typical Forward Voltage @Nominal If
 vs. Junction Temperature

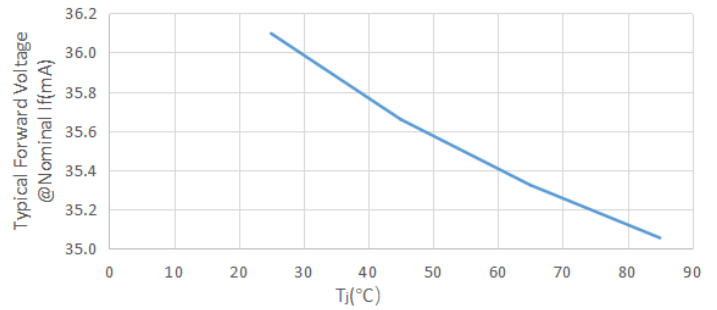

CTM-9 Typical Forward Voltage@Nominal If
 vs. Junction Temperature

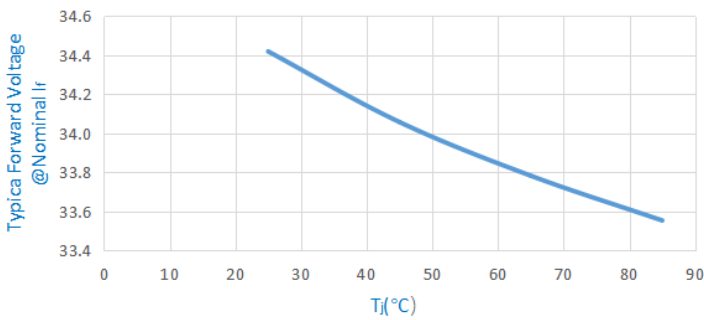

CTM-9 Series Package Dimensions

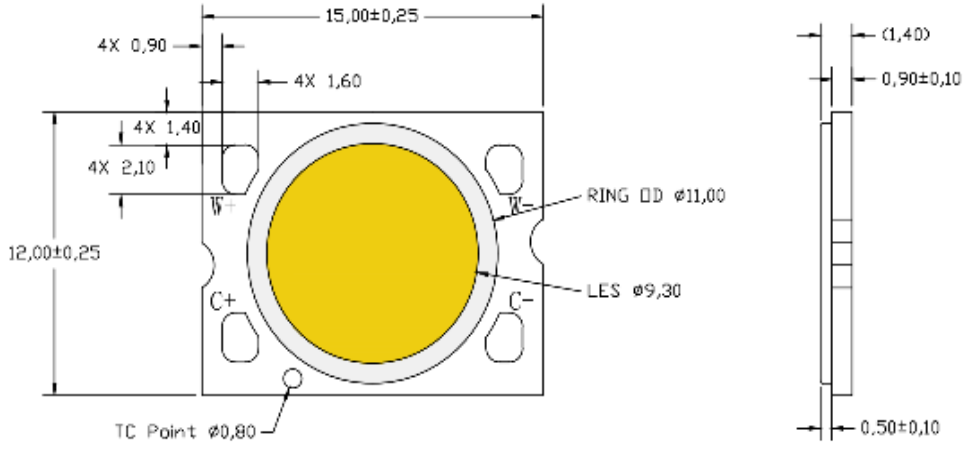

CTM-14 Series Package Dimensions

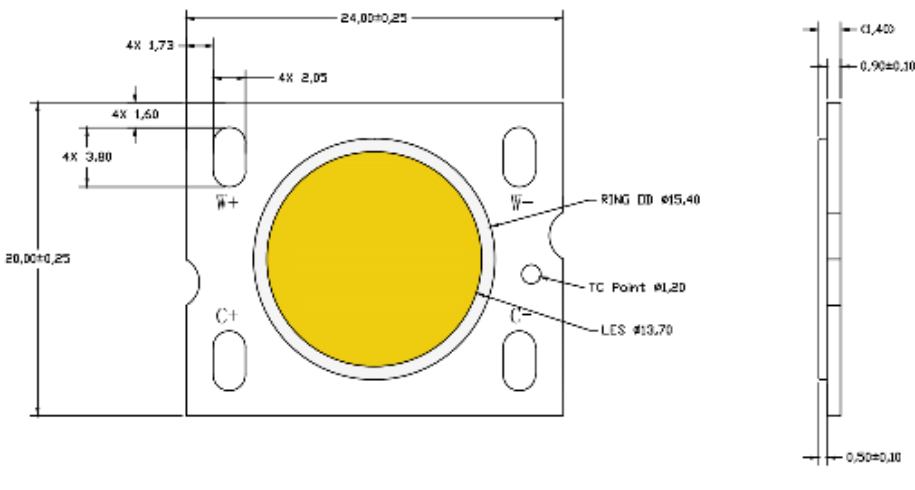

Shipping Container (CTM-9)

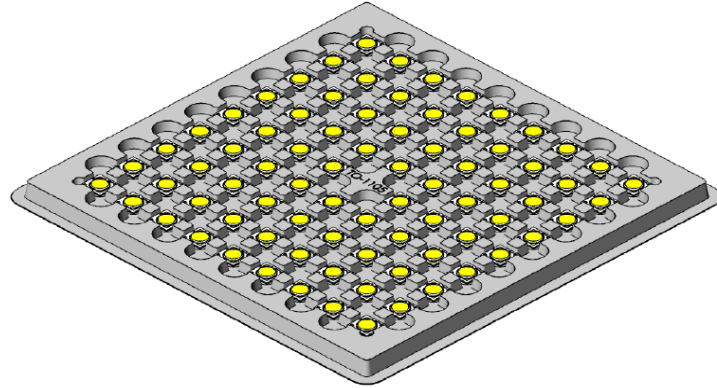
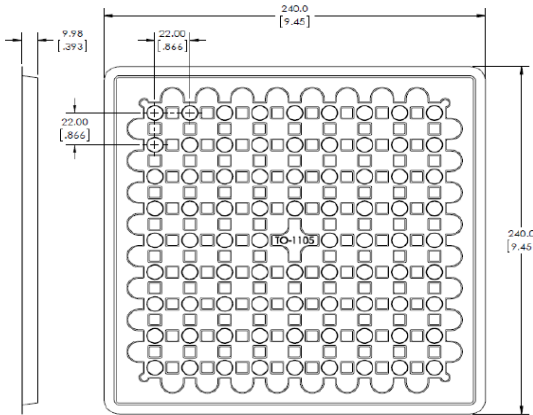

400 pcs per box
 Each bag is boxed for easier storage/ stacking

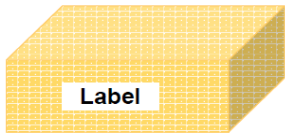

Trays are sealed in an anti-static bag

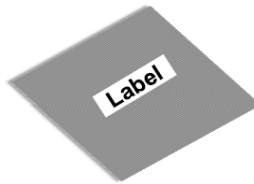

80 pcs per tray
 5 trays are stacked together with separate cover

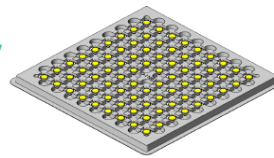

Shipping Container (CTM-14)

Similar to above but 30 pcs per tray and 150 pcs per box

Luminus Label Model:

 LUMINUS	Luminus Devices Inc	RoHS Compliant
XXXXXX-XX-XX (Manufacturer Part Number & Bin Kits)	Rev XX	
Bar code	Bar code	
XXX-XX-XX-XX-XX-XXXX-XX-X (Customer Part Number)		
XXXXXXXXXXXXXXXXXX (Box ID)	Qty: XX	
Bar code	Bar code	

Handling Notes for Luminus COBs

Luminus products are designed for robust performance in general lighting applications; however, care must be taken when handling and assembling the LEDs into their fixtures. To avoid damaging Luminus COBs, please follow these guidelines. The following is an overview of the application notes detailing some of the practices to follow when working with these devices. More detailed information is available on the Luminus website at www.luminus.com

General Handling

Devices are made to be lifted or carried with tweezers on two “mouse bite” locations. At no time should the devices be handled by or should anything come in contact with the light emitting surface (LES) area. There are electrical connections under the LES which, if damaged, will cause the device to fail.

Static Electricity

LEDs are electronic devices which can be damaged by electrostatic discharge (ESD). Please use appropriate measures to assure the devices do not experience ESD during their handling and/or storage. ESD protection guidelines should be used at all times when working with LEDs.

Storage: Luminus products are delivered in ESD shielded bags and should be stored in these bags until used.

Assembly: Individuals handling LEDs during assembly should be trained in ESD protection practices. Assemblers should maintain constant conductive contact with a path to ground by means of a wrist strap, ankle straps, mat, or other ESD protection system.

Transporting: When transporting the devices from one assembly area to another, ESD shielded carts and carriers should be used.

Electrical Contact

Luminus COBs are designed with electrical contact pads on their top surface. These pads are clearly marked with “+” and “-” polarity. Wires can be soldered to the contact pads for electrical connections or other solderless connector products are available. If wires are being soldered to the COB product, we recommend attaching these wires prior to mounting the devices to a heat sink. Please contact Luminus for specific recommendations on how to solder wires if not familiar with the standard practice. Luminus can also offer design recommendations for jigs to enable easy soldering of multiple products in rapid succession.

Chemical Compatibility

The resin material used to form the emitters inside the LES can get hydrocarbons from the surrounding environment. As a result, certain chemical compounds are not recommended for use with Luminus products. Use of these compounds can cause damage to the light output of the device and may permanently damage the device. Please refer to www.luminus.com for a list of the compounds not recommended for use with Luminus COB products.

Thermal Interface Material (TIM)

Proper thermal management is critical for successful operation of any LED system. Excess operating temperature can reduce the light output of the device, and excessive heating can cause permanent damage to the device. Proper TIM material is a crucial component for effective heat transfer away from the LED during normal operation. Please refer to www.luminus.com for specific recommendations for TIM solutions.

Human Eye Safety

Caution must be taken not to stare at the light emitted from Luminus LEDs, as severe eye damage may occur.

X-ON Electronics

Largest Supplier of Electrical and Electronic Components

Click to view similar products for [LED Lighting Modules](#) category:

Click to view products by [Luminus Devices](#) manufacturer:

Other Similar products are found below :

[LPS1-01C24-4070-00](#) [XHP50A-0L-02-0D0BH430E](#) [28085](#) [LMH020-0850-27G9-00000SS](#) [LMH020-0850-27G9-00001SS](#) [LMH020-1250-27G9-00001SS](#) [LMH020-1250-30G9-00000TW](#) [LMH020-2000-27G9-00001SS](#) [LMH020-3000-27G9-00000SS](#) [LMH020-3000-27G9-00000TW](#) [LMH020-3000-35GS-00000TW](#) [LMH020-6000-30G9-00001TW](#) [LMH020-6000-35G9-00001TW](#) [LMH020-6000-40G9-00001TW](#) [LMH020-8000-30G9-00001TW](#) [LMH020-8000-40G9-00001TW](#) [LMR020-0650-35F9-20100TW](#) [LLT-3R](#) [Z-G4-15WW](#) [ZM-1610-CW](#) [ZM-189-CW](#) [ZM-6223-CW](#) [ZRS-8480-CW](#) [ZRS-8480-WW](#) [L218-3080024C30000](#) [L218-3080048C00000](#) [L218-3580024C30000](#) [L218-3580048C00000](#) [L218-4080024C30000](#) [L218-4090024C30000](#) [L218-4090048C00000](#) [L218-5080024C30000](#) [L2M0-4070003MC3300](#) [L2M0-4070004MC2200](#) [L2M0-5070003MC3300](#) [L2M0-5770005MC3300](#) [CBM-120-FR-C15-RA100](#) [CBM-120-UV-C31-K380-21](#) [CBM-120-UV-X31-I365-22](#) [CBM-120-UV-X31-L400-22](#) [CBM-120-UV-X31-M380-22](#) [CBM-90-IRD-X33-K850](#) [CBT-140-WCS-L16-UA120](#) [CBT-140-WCS-L16-UA122](#) [CBT-140-WCS-L16-UA123](#) [CBT-140-WDH-L16-QB220](#) [CBT-90-B-L11-G100](#) [CBT-90-B-L11-H101](#) [CBT-90-B-L11-J101](#) [CBT-90-RX-L15-BN101](#)