

Sensus™ LED Series

Pure White Targeted COB Arrays Below the Black Body Locus (BBL) Data Sheet



Table of Contents

Technology Overview2

Test Specifications2

Chromaticity Bins3

Product Ordering & Shipping
Part Numbers4

Product Typical Flux Range 5

Operating Characteristics ..7

Optical and Electrical Character-
istics..... 12

Spectra 19

Mechanical Dimensions .. 20

Packaging Information ... 20

Handling Notes 28

Features:

- Matching the human perception of “Pure white” light
- Designed to provide the look and feel of ceramic metal halide lights
- Wide product range from 300lm to over 7,500lm
- 3000K and 3500K, 80 CRI and 90 CRI
- 3 SDCM color binning accuracy
- Excellent optical uniformity and color over angle consistency
- Exceptional long term color stability
- Superior thermal conductivity for uniform heat spreading
- Environmentally friendly: RoHS and REACH compliant
- UL Recognized, File # E465703



Applications

- Retail Shop Lighting
- Spotlights/Track Lights
- CMH replacement LED lamps
- Halogen replacement LED lamps
- Hospitality Lighting
- Architectural and Specialty

Technology Overview

Luminus Chip-on-Board (COB) LED series offers a complete lighting class solution designed for high performance illumination applications. The Sensus LED series has been specially design for retail shop ligthing where enhanced red coloring is a preferred lighting standard. The selection covers a wide lumen range from less than 300lm to over 3,000lm, and is focused on the major market color and CRI of 3000K and 80 CRI. These innovative breakthroughs allow illumination engineers and designers to develop lighting solutions with maximum efficacy, brightness and overall quality.

Reliability

Designed from the ground up, the Luminus COB LED is one of the most reliable light sources in the world today. Having passed a rigorous suite of environmental and mechanical stress tests, including mechanical shock, vibration, temperature cycling and humidity. Only then are the devices qualified for use in a wide range of lighting application including some of the most demanding commercial applications. Delivered with fully qualified LM-80 test data and TM-21 lifetime results that certify lumen maintenance at 35,000 hours or more, Luminus COB LEDs are ready for the toughest challenges.

UL Recognized Compliance

Luminus COB arrays are tested in accordance with ANSI/UL 8750 to ensure safe operation for their intended applications.

REACH & RoHS Compliance

All LED products manufactured by Luminus are REACH and RoHS compliant and free of hazardous materials, including lead and mercury.

Understanding Luminus COB LED Test Specifications

Every Luminus LED is fully tested to ensure it meets the high quality standards customers have come to expect from Luminus' products.

Traceability

Each Luminus COB LED is marked with a 2D bar code that contains a unique serial number. With this serial number, Luminus has the ability to provide customers with actual test data measurements for a specific LED. In addition, the 2D bar code is linked to manufacturing date codes that enables traceability of production processes and materials.

Chromaticity Bin Range

Chromaticity binning delivers color consistency for every order. Standard products are delivered with a 3-step MacAdam ellipse. This ensures color performance matching in the application. These tightly controlled, small distribution bins provide customers predictable, repeatable colors.

Testing Temperature

Luminus COB products are measured at temperatures typical for the LED operating in the fixture. Each device is tested at 85°C junction temperature eliminating the need to scale data sheet specifications to real world situations.

Chromaticity Bin Structure

Chromaticity Bins: 1931 CIE Curve

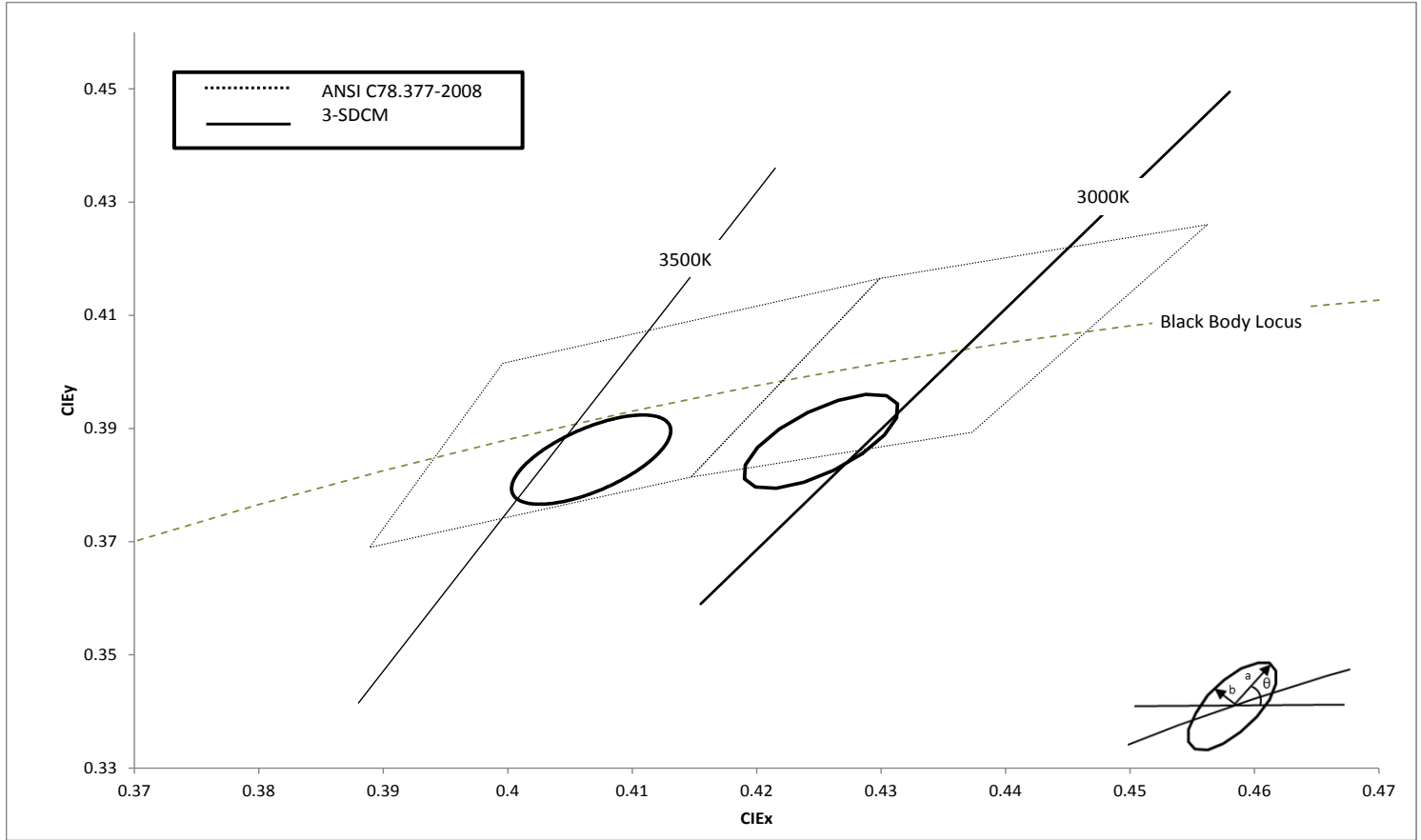

Sensus™ LED White Chromaticity Bins

The following tables describe the ANSI bin center points, the orientation angle for the MacAdam ellipse (θ°), and the maximum radii for the ellipses. The ANSI Bin is provided for reference.

CCT	Center Point		θ°	3-step Bin	
	CIE _x	CIE _y		a	b
3000K	0.4285	0.3933	53.1	0.00834	0.00408
3500K	0.4067	0.3845	54	0.00927	0.00414

*Note: Luminus maintains a +/- 0.005 tolerance on chromaticity (CIE_x and CIE_y) measurements.

Product Ordering and Shipping Part Number Nomenclature

All Sensus LED products are packaged and labeled with part numbers as outlined in the table on page 5 and 6. When shipped, each package will contain only a single flux and chromaticity bin. The part number designation is as follows:

Sensus™ LED Series														
CXM	—	XX	—	CT	—	XX	—	36	—	QPPP	—	FG	—	W
Product Family	Light Emitting Surface Diameter ¹	Color Temperature ²	Color Rendering Index (CRI) ³	Voltage (typical)	Package Configurator	Flux Bin	Chromaticity Bin							
CXM: Chip on Board	XX: LES Diameter (mm) Approximate	30	CRI	Volts	AA02 (Basic package)	Lumens	See page 3 for bins							

Note 1: XX nomenclature corresponds to the following:

- 6 = 6.3mm
- 7 = 7.5mm
- 9 = 9mm
- 11 = 10.9mm
- 14 = 13.5mm
- 18 = 17.5mm
- 22 = 22mm

Note 2: CT Nomenclature corresponds to the following

- 30 is 3000K
- 35 is 3500K

Note 3: XX Color Rendering nomenclature corresponds to the following

- 80 = 80 CRI
- 90 = 90 CRI

Note 4: AA02 is a standard package configurator

AC02 is an alternative substrate size

Color Temperature, CRI and R9 Values

Color Temperatures	XX Value	CRI	R9
3000K, 3500K	80	>80	>0
	90	>90	>50

Note: Luminus part numbers may be accompanied by prefixes or suffixes. The most common is the “Rev01” suffix indicating a part is fully released and carries a full warranty. These additional characters may appear on shipping labels, packing slips and invoices. In all cases the basic part number described above will always be included.

Sensus™ LED Series Part Numbers (Typical)

The following tables describe products with typical flux and minimum flux measured at typical currents and specified at 85°C. The values at 25°C are calculated and shown for reference only. All products are measured and specified at 85°C junction temperature.

Output Flux (lm)				CRI	Typ. Current (mA)	Ordering Part Number
Typ. (85°C)	Min. (85°C)	Typ. (calculated) (25°C)				3-step MacAdam Ellipse
445	420	495	3000K	80	120	CXM-6-30-80-36-AA02-F2-3
585	555	645	3000K	80	160	CHM-6-30-80-36-AA02-F2-3
615	585	685	3000K	80	160	CXM-7-30-80-36-AA02-F2-3
525	495	580	3000K	90	160	CXM-7-30-90-36-AA02-F2-3
625	590	695	3000K	80	160	CLM-9-30-80-36-AC02-F2-3
						CLM-9-30-80-36-AA02-F2-3
930	885	1,025	3000K	80	240	CXM-9-30-80-36-AC02-F2-3
						CXM-9-30-80-36-AA02-F2-3
960	910	1,065	3500K	90	240	CXM-9-35-80-36-AC02-F2-3
						CXM-9-35-80-36-AA02-F2-3
780	750	870	3000K	90	240	CXM-9-30-90-36-AC02-F2-3
						CXM-9-30-90-36-AA02-F2-3
825	785	910	3500K	90	240	CXM-9-35-90-36-AC02-F2-3
						CXM-9-35-90-36-AA02-F2-3
1,310	1,245	1,455	3000K	80	360	CHM-9-30-80-36-AC02-F2-3
						CHM-9-30-80-36-AA02-F2-3
1,350	1,280	1,501	3500K	90	360	CHM-9-35-80-36-AC02-F2-3
						CHM-9-35-80-36-AA02-F2-3
1,110	1,050	1,230	3000K	90	360	CHM-9-30-90-36-AC02-F2-3
						CHM-9-30-90-36-AA02-F2-3
1,160	1,100	1,285	3500K	90	360	CHM-9-35-90-36-AC02-F2-3
						CHM-9-35-90-36-AA02-F2-3
1,865	1,770	2,050	3000K	80	480	CXM-11-30-80-36-AC02-F2-3
						CXM-11-30-80-36-AB02-F2-3
1,580	1,472	1,745	3000K	90	480	CXM-11-30-90-36-AC02-F2-3
						CXM-11-30-90-36-AB02-F2-3

*Note: Luminus maintains a +/- 6% tolerance on flux measurements.

Luminus maintains a +/- 2% tolerance on CRI measurements.

Sensus™ LED Series Part Numbers (Typical)

The following tables describe products with typical flux and minimum flux measured at typical currents and specified at 85°C. The values at 25°C are calculated and shown for reference only. All product is measured and specified at 85°C junction temperature. Luminus may choose to ship a smaller chromaticity bin in an order for a larger.

Output Flux (lm)			CCT	CRI	Typ. Current (mA)	Ordering Part Number
Typ. (85°C)	Min. (85°C)	Typ. (calculated) (25°C)				3-step MacAdam Ellipse
1,930	1,830	2,135	3000K	80	480	CXM-14-30-80-36-AC02-F2-3
						CXM-14-30-80-36-AA02-F2-3
1,985	1,885	1,105	3500K			CXM-14-35-80-36-AC02-F2-3
						CXM-14-35-80-36-AA02-F2-3
1,635	1,550	1,810	3000K	90	480	CXM-14-30-90-36-AC02-F2-3
						CXM-14-30-90-36-AA02-F2-3
1,710	1,625	1,900	3500K			CXM-14-35-90-36-AC02-F2-3
						CXM-14-35-90-36-AA02-F2-3
2,660	2,525	2,925	3000K	80	720	CHM-14-30-80-36-AC02-F2-3
						CHM-14-30-80-36-AA02-F2-3
2,755	2,615	3,030	3500K			CHM-14-35-80-36-AC02-F2-3
						CHM-14-35-80-36-AA02-F2-3
2,265	2,150	2,495	3000K	90	720	CHM-14-30-90-36-AC02-F2-3
						CHM-14-30-90-36-AA02-F2-3
2,345	2,225	2,580	3500K			CHM-14-35-90-36-AC02-F2-3
						CHM-14-35-90-36-AA02-F2-3
3,210	3,050	3,565	3000K	80	800	CXM-18-30-80-36-AA02-F2-3
2,735	2,600	3,030		90		CXM-18-30-90-36-AA02-F2-3
5,130	4,870	5,700	3000K	80	1,280	CXM-22-30-80-36-AC02-F2-3
4,360	4,140	4,800		90		CXM-22-30-90-36-AC02-F2-3
7,090	6,735	7,800	3000K	80	1,920	CHM-22-30-80-36-AC02-F2-3
6,050	5,745	6,650		90		CHM-22-30-90-36-AC02-F2-3

*Note: Luminus maintains a +/- 6% tolerance on flux measurements.

Luminus maintains a +/- 2% tolerance on CRI measurements.

CXM-6 Operating Characteristics¹
Optical and Electrical Characteristics

Parameter	Symbol	Minimum	Typical	Maximum	Unit
Forward Current (36V) ²	I_f		120	355	mA
Forward Voltage ³	V_f	33.5	35	37.5	V
Power			4.3	13	W
Operating Case Temperature ⁴	T_c			105	°C
Light Emitting Surface Diameter	LES		6.3		mm
Thermal Resisittance (junction-to-case)	Θ_{jc}		2.33		°C/W
Junction Temperature	T_j			140	°C
Viewing Angle			120		Degree

CXM-7 Operating Characteristics¹
Optical and Electrical Characteristics

Parameter	Symbol	Minimum	Typical	Maximum	Unit
Forward Current (36V) ²	I_f		160	360	mA
Forward Voltage ³	V_f	33.5	35	37.5	V
Power			5.6	13.5	W
Operating Case Temperature ⁴	T_c			105	°C
Light Emitting Surface Diameter	LES		7.5		mm
Thermal Resisittance (junction-to-case)	Θ_{jc}		1.9		°C/W
Junction Temperature	T_j			140	°C
Viewing Angle			120		Degree

CHM-6 Operating Characteristics¹
Optical and Electrical Characteristics

Parameter	Symbol	Minimum	Typical	Maximum	Unit
Forward Current (36V) ²	I_f		160	360	mA
Forward Voltage ³	V_f	33.5	35	37.5	V
Power			5.6	13.5	W
Operating Case Temperature ⁴	T_c			105	°C
Light Emitting Surface Diameter	LES		6.3		mm
Thermal Resisitance (junction-to-case)	Θ_{jc}		1.55		°C/W
Junction Temperature	T_j			140	°C
Viewing Angle			120		Degree

CLM-9 Operating Characteristics¹
Optical and Electrical Characteristics

Parameter	Symbol	Minimum	Typical	Maximum	Unit
Forward Current ²	I_f		160	360	mA
Forward Voltage ³	V_f	33.5	35	37.5	V
Power			5.6	13.5	W
Operating Case Temperature ⁴	T_c			105	°C
Light Emitting Surface Diameter	LES		9.0		mm
Thermal Resisitance (junction-to-case)	Θ_{jc}		1.55		°C/W
Junction Temperature	T_j			140	°C
Viewing Angle			120		Degree

CXM-9 Operating Characteristics¹
Optical and Electrical Characteristics

Parameter	Symbol	Minimum	Typical	Maximum	Unit
Forward Current ²	I_f		240	550	mA
Forward Voltage ³	V_f	33.5	35	37.5	V
Power			8.6	21	W
Operating Case Temperature ⁴	T_c			100	°C
Light Emitting Surface Diameter	LES		9		mm
Thermal Resisitance (junction-to-case)	Θ_{jc}		1.51		°C/W
Junction Temperature	T_j			140	°C
Viewing Angle			120		Degree

CHM-9 Operating Characteristics¹
Optical and Electrical Characteristics

Parameter	Symbol	Minimum	Typical	Maximum	Unit
Forward Current ²	I_f		360	550	mA
Forward Voltage ³	V_f	32	35	37.5	V
Power			12.6	21	W
Operating Case Temperature ⁴	T_c			105	°C
Light Emitting Surface Diameter	LES		9		mm
Thermal Resisitance (junction-to-case)	Θ_{jc}		0.85		°C/W
Junction Temperature	T_j			140	°C
Viewing Angle			120		Degree

CXM-11 Operating Characteristics¹
Optical and Electrical Characteristics

Parameter	Symbol	Minimum	Typical	Maximum	Unit
Forward Current ²	I_f		480	960	mA
Forward Voltage ³	V_f	33.5	35	37.5	V
Power			16.8	34	W
Operating Case Temperature ⁴	T_c			105	°C
Light Emitting Surface Diameter	LES		11		mm
Thermal Resisitance (junction-to-case)	Θ_{jc}		N/A		°C/W
Junction Temperature	T_j			140	°C
Viewing Angle			120		Degree

CXM-14 Operating Characteristics¹
Optical and Electrical Characteristics

Parameter	Symbol	Minimum	Typical	Maximum	Unit
Forward Current ²	I_f		480	1,090	mA
Forward Voltage ³	V_f	33.5	35	37.5	V
Power			17.3	41	W
Operating Case Temperature	T_c			105	°C
Light Emitting Surface Diameter	LES		13.5		mm
Thermal Resisitance (junction-to-case)	Θ_{jc}		0.87		°C/W
Junction Temperature	T_j			140	°C
Viewing Angle			120		Degree

CHM-14 Operating Characteristics¹
Optical and Electrical Characteristics

Parameter	Symbol	Minimum	Typical	Maximum	Unit
Forward Current ²	I_f		720	1,090	mA
Forward Voltage ³	V_f	32	35	37.5	V
Power			25.2	41	W
Operating Case Temperature	T_c			105	°C
Light Emitting Surface Diameter	LES		13.5		mm
Thermal Resisitance (junction-to-case)	Θ_{jc}		0.46		°C/W
Junction Temperature	T_j			140	°C
Viewing Angle			120		Degree

CXM-18 Operating Characteristics¹
Optical and Electrical Characteristics

Parameter	Symbol	Minimum	Typical	Maximum	Unit
Forward Current ²	I_f		800	1,800	mA
Forward Voltage ³	V_f	33.5	35	37.5	V
Power			29	67.5	W
Operating Case Temperature	T_c			105	°C
Light Emitting Surface Diameter	LES		17.5		mm
Thermal Resisitance (junction-to-case)	Θ_{jc}		0.56		°C/W
Junction Temperature	T_j			140	°C
Viewing Angle			120		Degree

CXM-22 Operating Characteristics¹
Optical and Electrical Characteristics

Parameter	Symbol	Minimum	Typical	Maximum	Unit
Forward Current ²	I_f		1,280	2,900	mA
Forward Voltage ³	V_f	33.5	35	37.5	V
Power			45	109	W
Operating Case Temperature ⁴	T_c			105	°C
Light Emitting Surface Diameter	LES		22		mm
Thermal Resisitance (junction-to-case)	Θ_{jc}		0.37		°C/W
Junction Temperature	T_j			140	°C
Viewing Angle			120		Degree

CHM-22 Operating Characteristics¹
Optical and Electrical Characteristics

Parameter	Symbol	Minimum	Typical	Maximum	Unit
Forward Current ²	I_f		1,920	2,900	mA
Forward Voltage ³	V_f	32	35	37.5	V
Power			67	109	W
Operating Case Temperature ⁴	T_c			105	°C
Light Emitting Surface Diameter	LES		22		mm
Thermal Resisitance (junction-to-case)	Θ_{jc}		0.2		°C/W
Junction Temperature	T_j			140	°C
Viewing Angle			120		Degree

Operating Characteristics Notes

- Note 1: Ratings are based on operation at a constant junction temperature of $T_j = 85^\circ\text{C}$.
- Note 2: To prevent damage refer to operating conditions for maximum operating conditions
- Note 3: Voltage is rated at typical forward current. For voltage at higher drive current, refer to performance graphs.
- Note 4: Sensus COB minimum operating current is suggested to be no less than 20% of the typical value. While lower levels will not harm the device, they may result in uneven lighting across the LES area.
- Note 5: Caution must be taken not to stare at the light emitted from these LEDs. Under special circumstances, the high intensity could damage the eye.
- Note 6: Data sheets are subject to changes without prior notice. Please refer to the Luminus web site for the latest data sheet revisions.

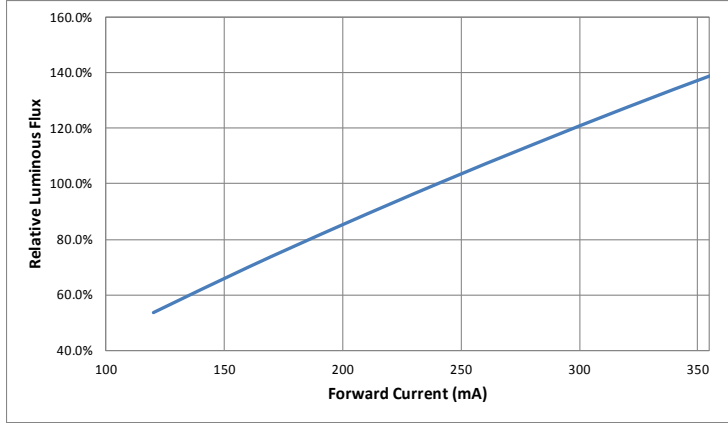
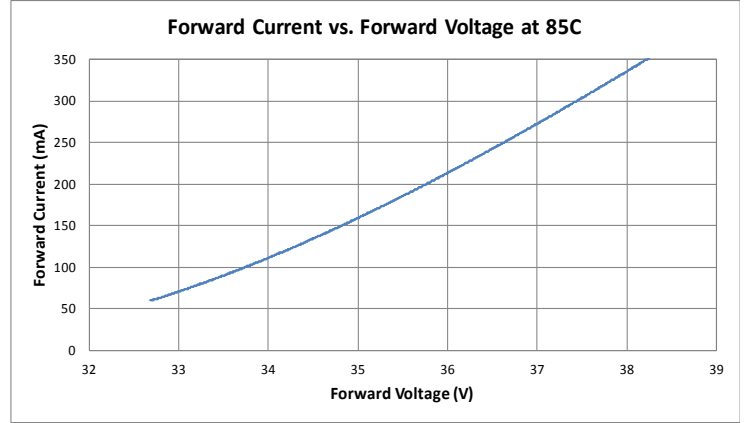
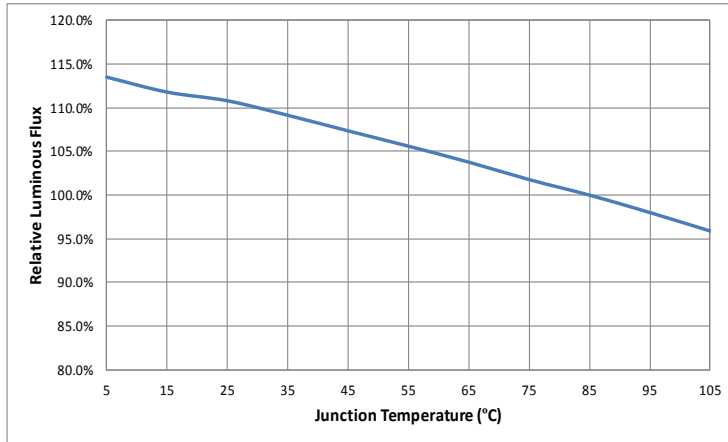
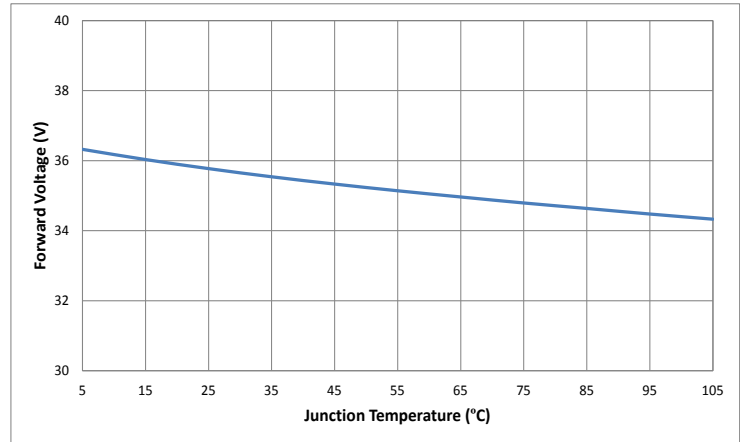
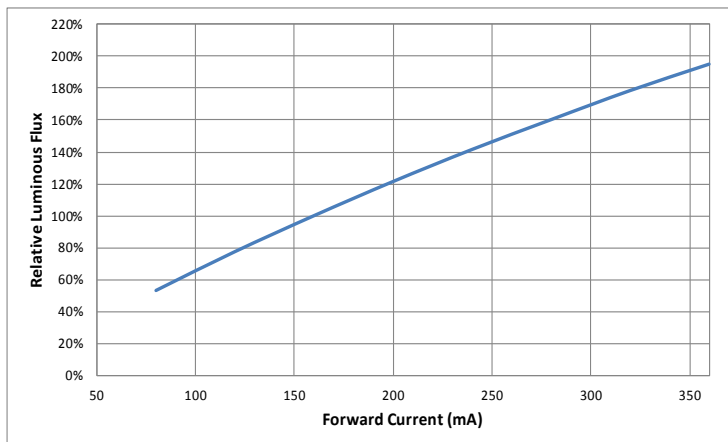
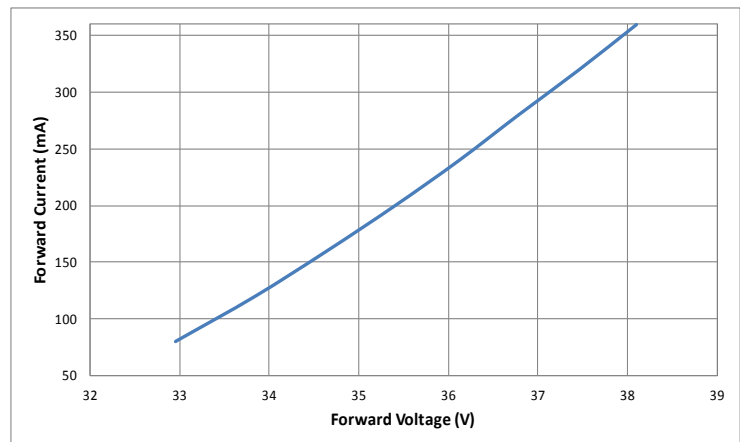
CXM-6 Optical & Electrical Characteristics
Relative Output Flux vs. Forward Current @ 85°C

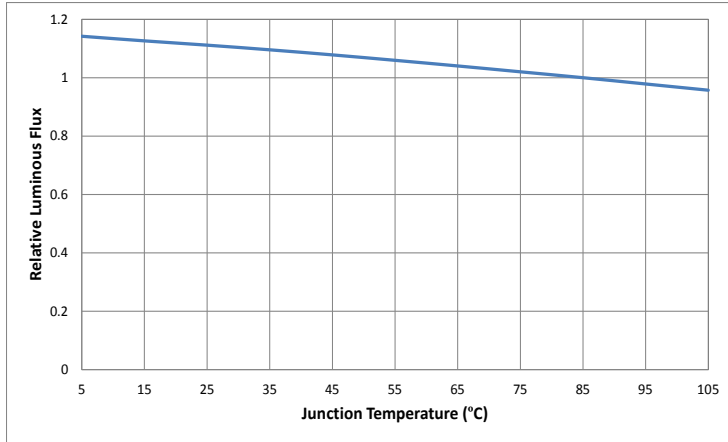
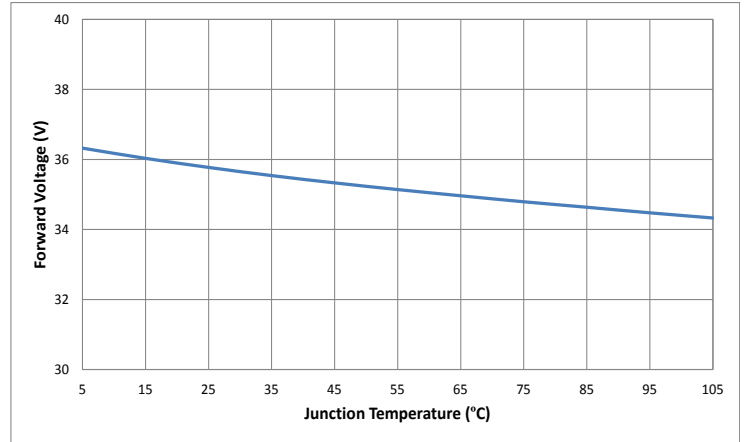
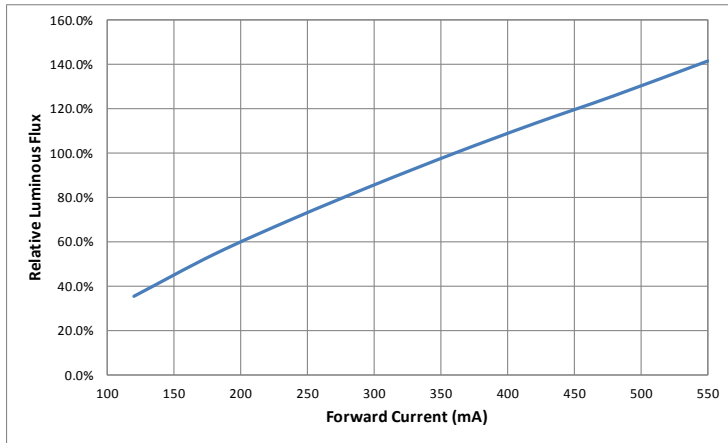
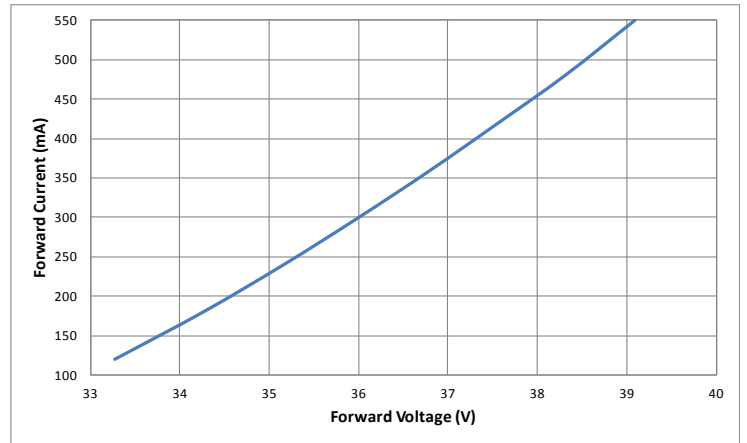
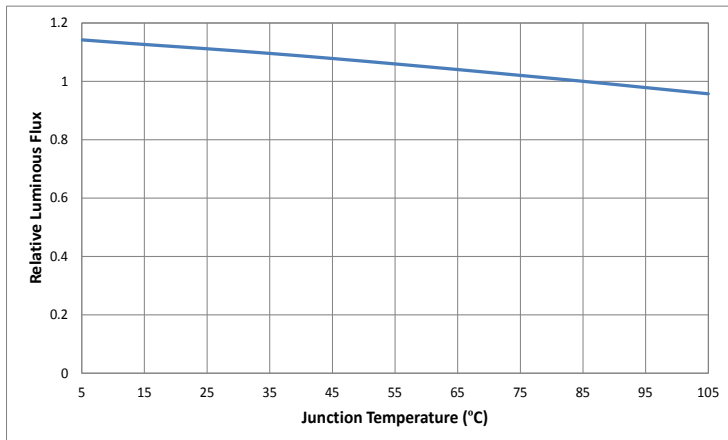
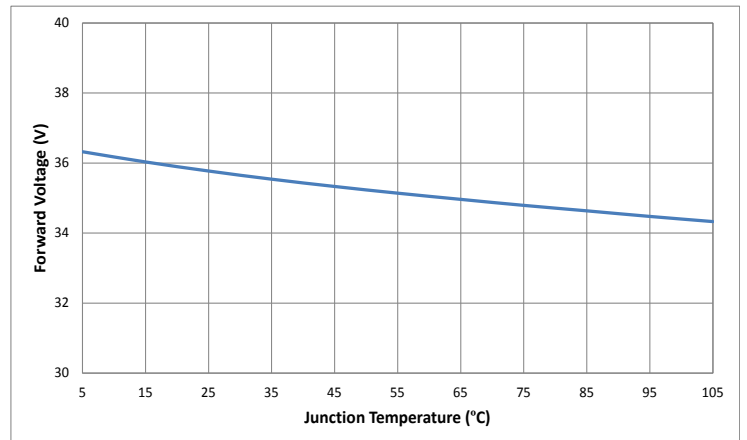
Forward Current vs. Forward Voltage @ 85°C

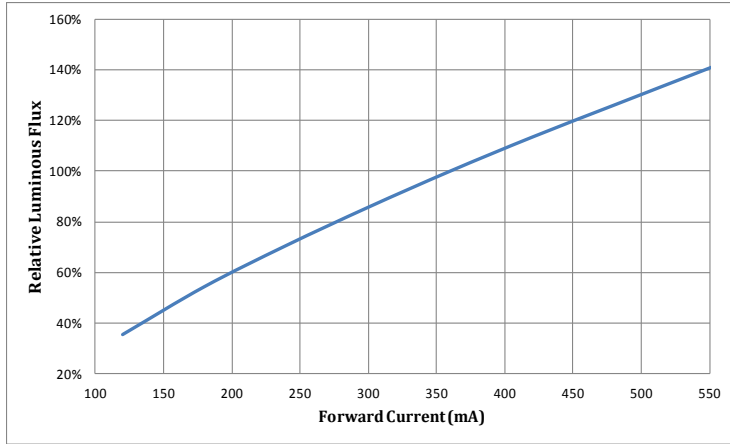
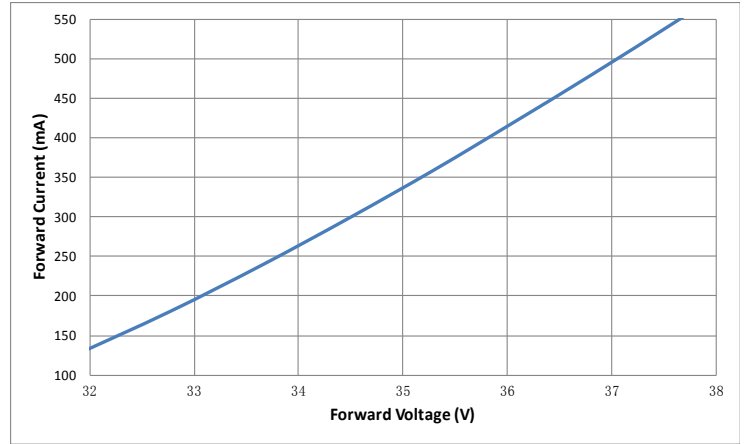
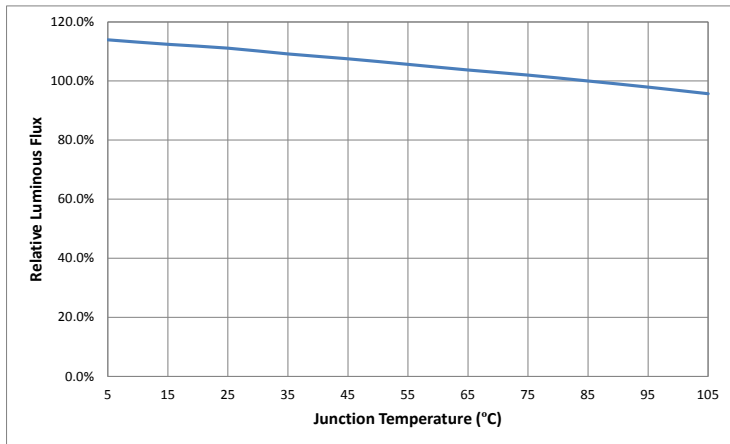
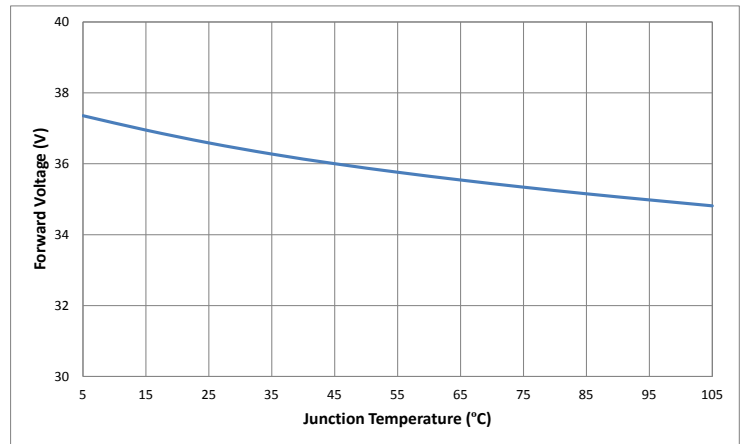
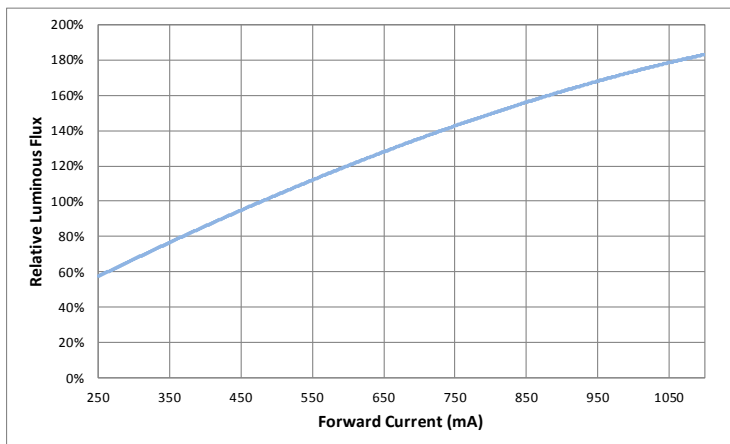
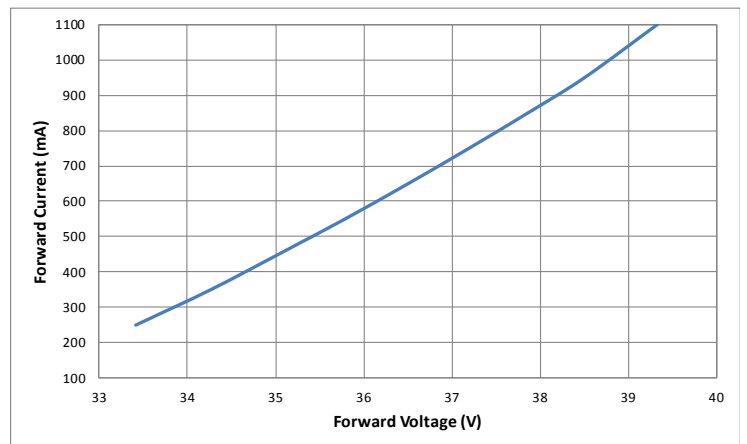
Relative Output Flux vs. Junction Temperature

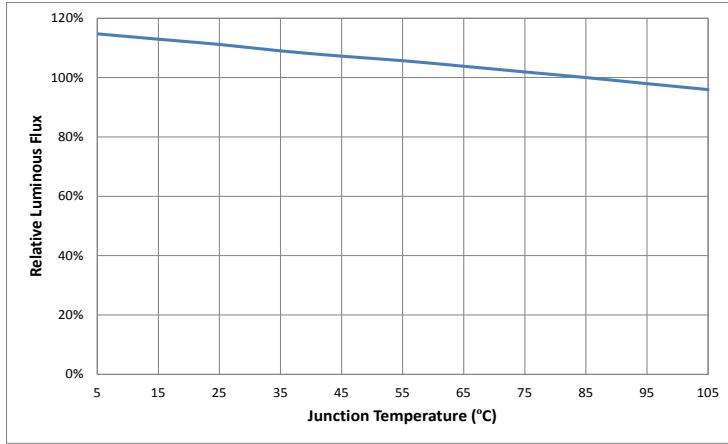
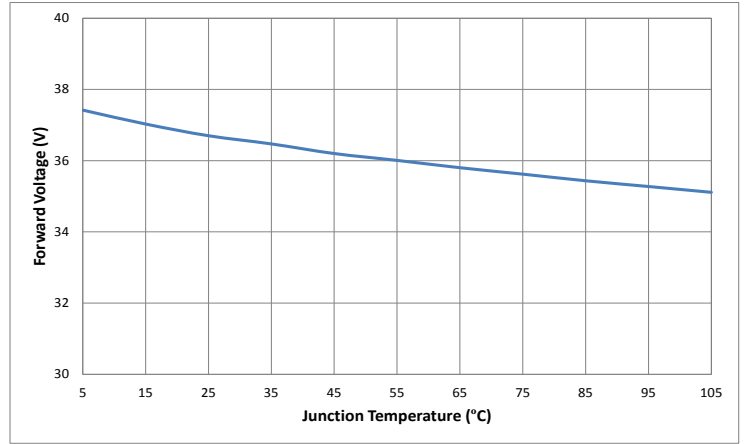
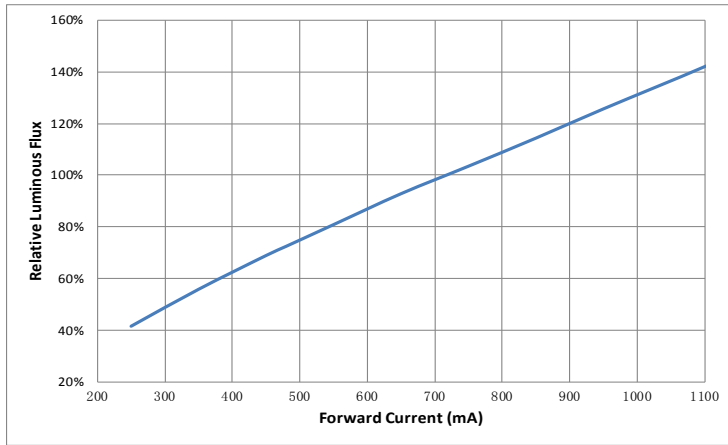
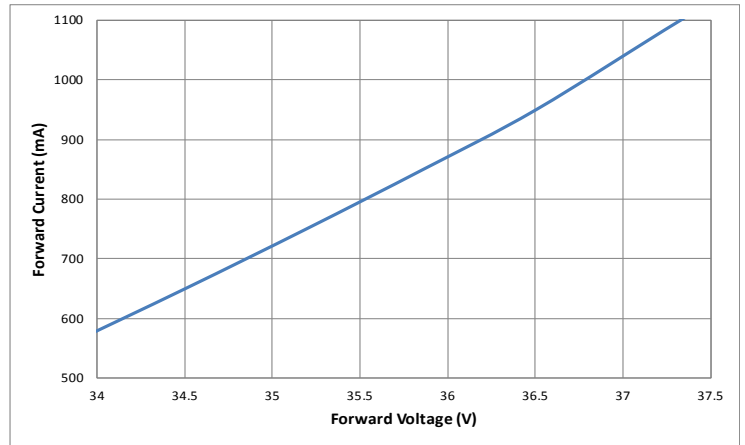
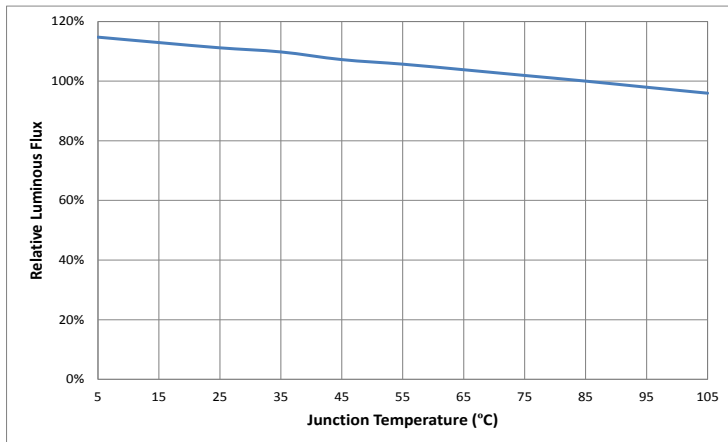
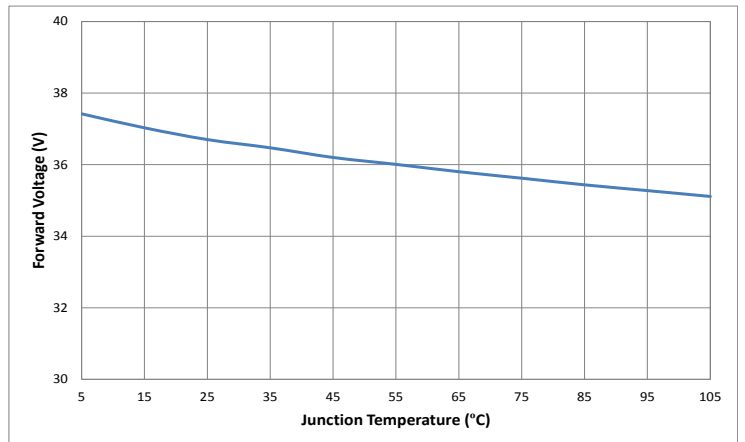
Change in Voltage vs. Junction Temperature

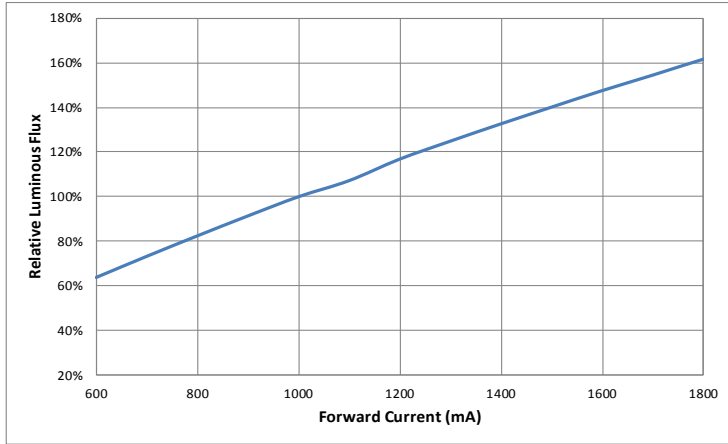
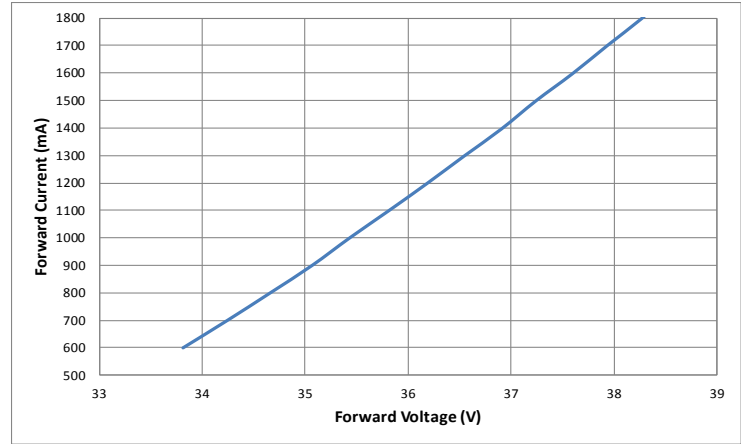
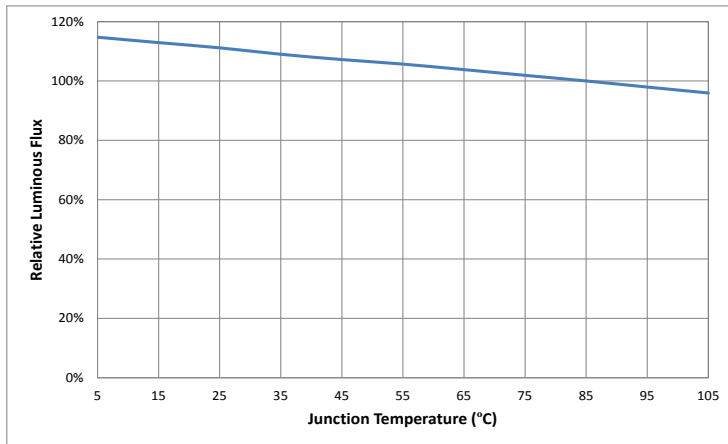
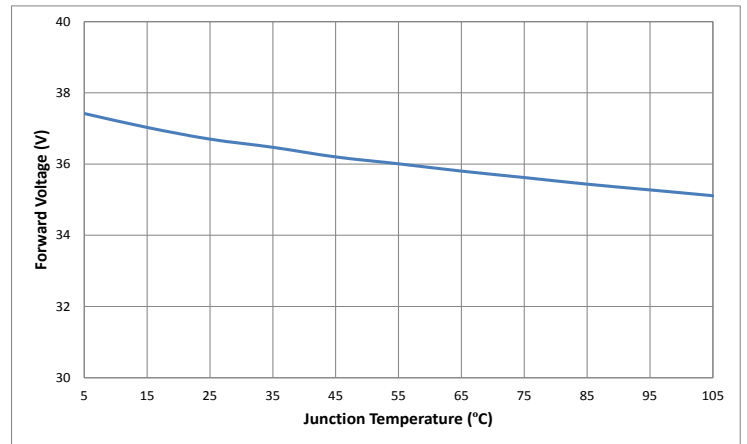
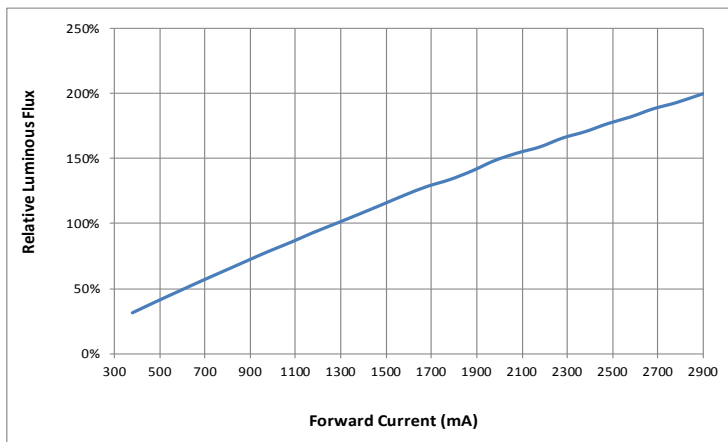
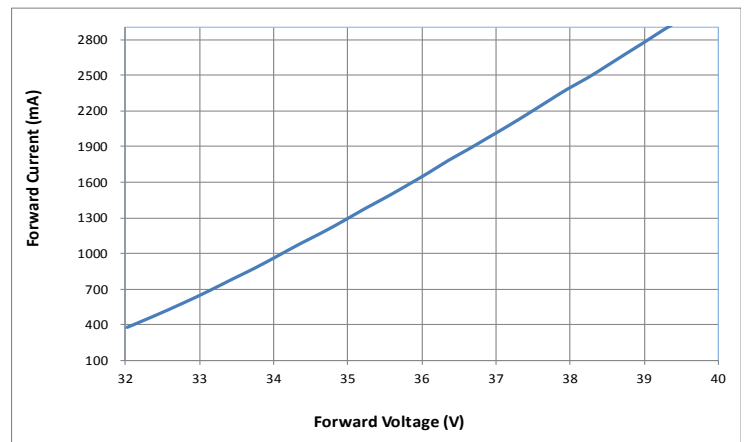
CHM-6, CXM-7, CLM-9 Optical & Electrical Characteristics
Relative Output Flux vs. Forward Current @ 85°C

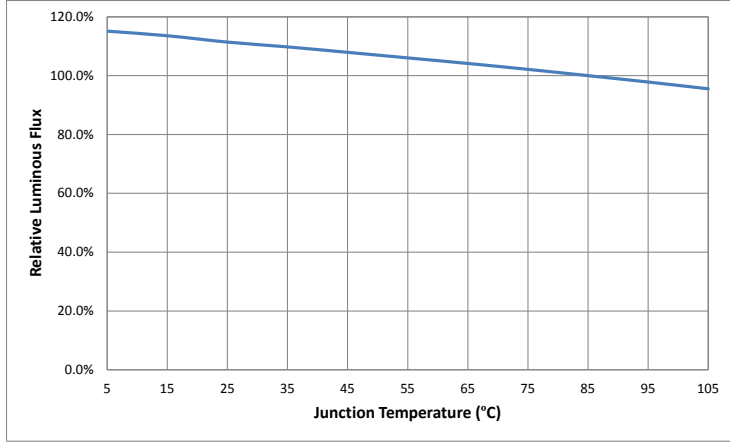
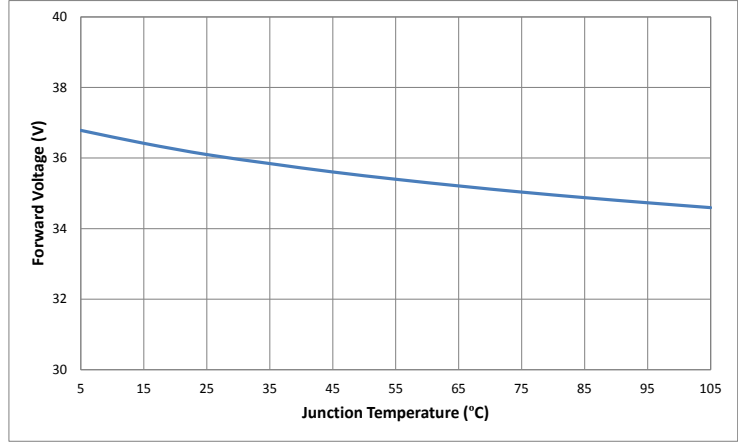
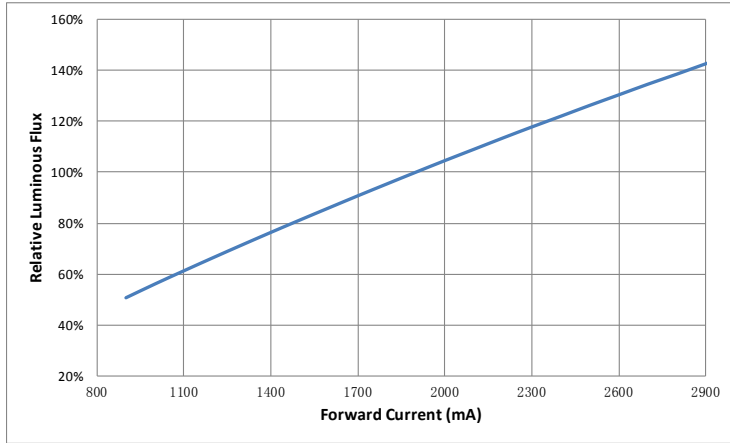
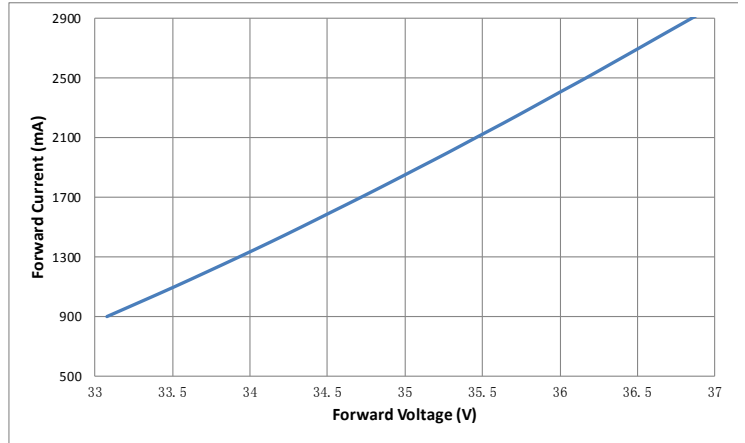
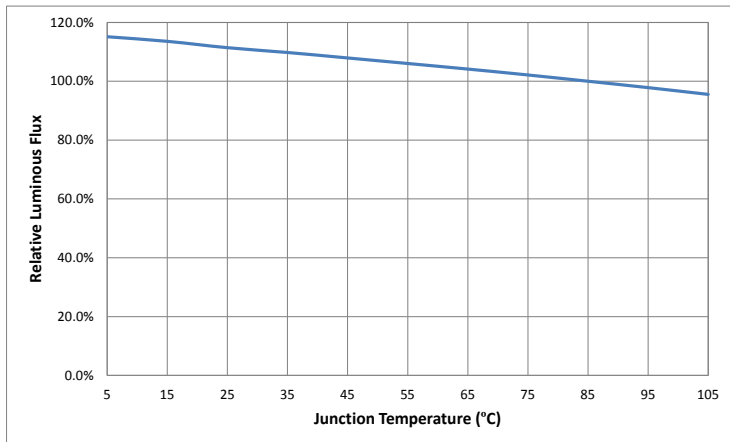
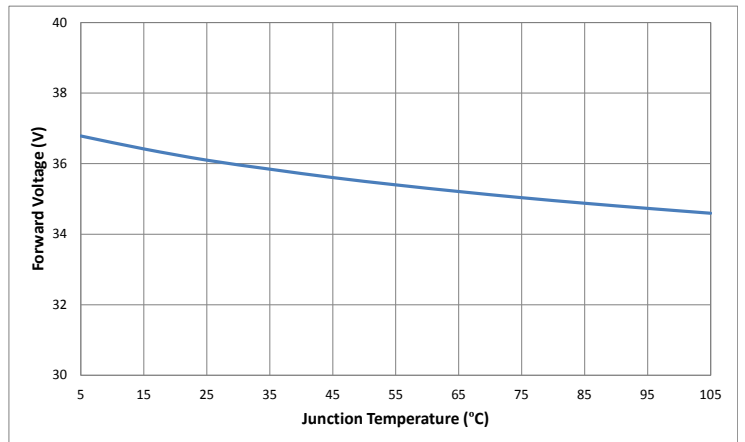
Forward Current vs. Forward Voltage @ 85°C

CHM-6, CXM-7, CLM-9 Optical & Electrical Characteristics
Relative Output Flux vs. Junction Temperature

Change in Voltage vs. Junction Temperature

CXM-9 Optical & Electrical Characteristics
Relative Output Flux vs. Forward Current @ 85°C

Forward Current vs. Forward Voltage @ 85°C

Relative Output Flux vs. Junction Temperature

Change in Voltage vs. Junction Temperature

CHM-9 Optical & Electrical Characteristics
Relative Output Flux vs. Forward Current @ 85°C

Forward Current vs. Forward Voltage @ 85°C

Relative Output Flux vs. Junction Temperature

Change in Voltage vs. Junction Temperature

CXM-11 & CXM-14 Optical & Electrical Characteristics
Relative Output Flux vs. Forward Current @ 85°C

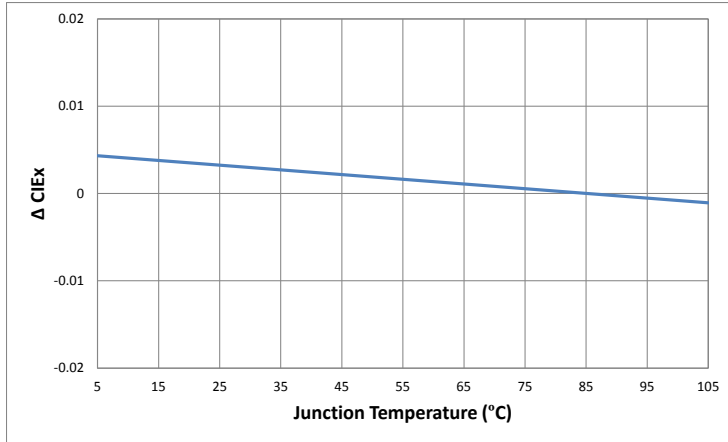
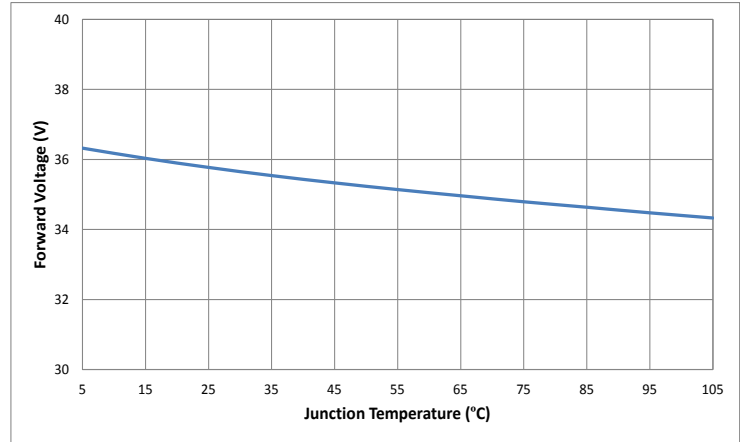
Forward Current vs. Forward Voltage @ 85°C

CXM-11 & CXM-14 Optical & Electrical Characteristics
Relative Output Flux vs. Junction Temperature

Change in Voltage vs. Junction Temperature

CHM-14 Optical & Electrical Characteristics
Relative Output Flux vs. Forward Current @ 85°C

Forward Current vs. Forward Voltage @ 85°C

Relative Output Flux vs. Junction Temperature

Change in Voltage vs. Junction Temperature

CXM-18 Optical & Electrical Characteristics
Relative Output Flux vs. Forward Current @ 85°C

Forward Current vs. Forward Voltage @ 85°C

Relative Output Flux vs. Junction Temperature

Change in Voltage vs. Junction Temperature

CXM-22 Optical & Electrical Characteristics
Relative Output Flux vs. Forward Current @ 85°C

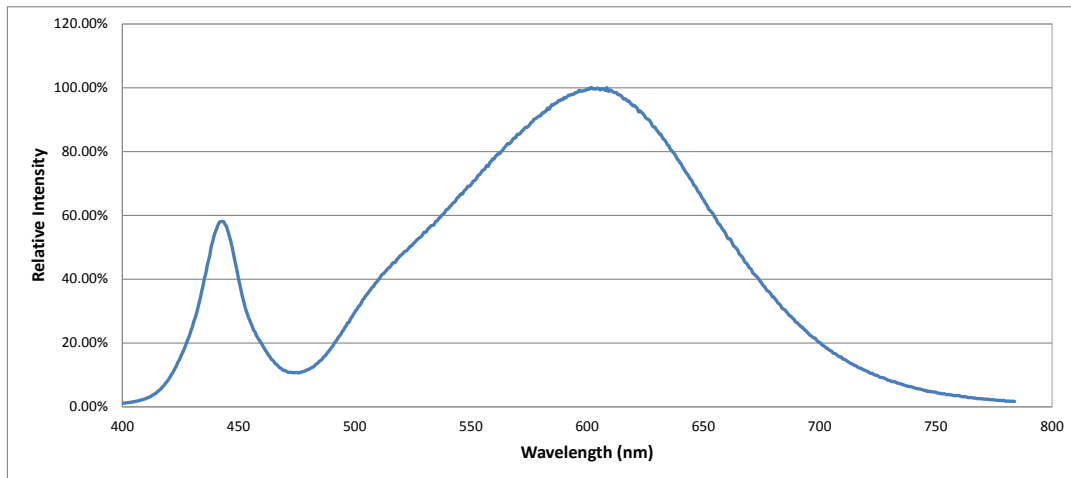
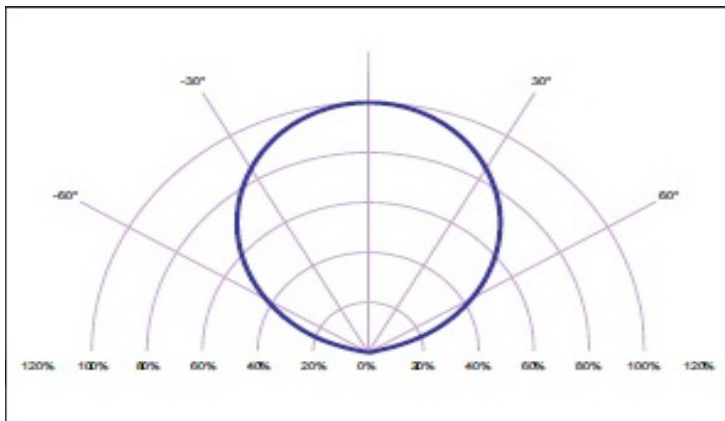
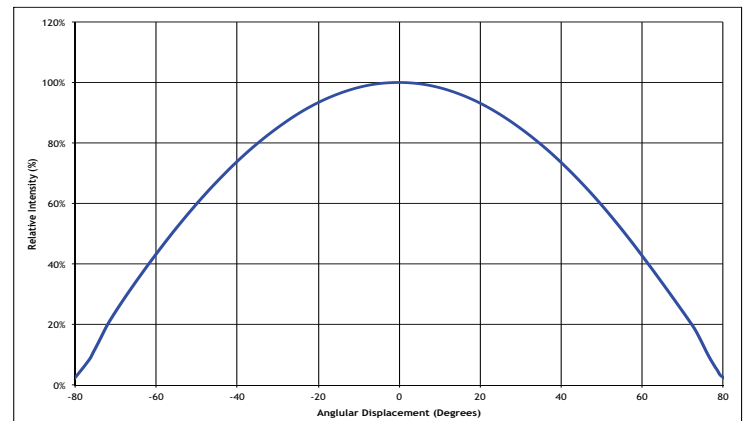
Forward Current vs. Forward Voltage @ 85°C

CXM-22 Optical & Electrical Characteristics
Relative Output Flux vs. Junction Temperature

Change in Voltage vs. Junction Temperature

CHM-22 Optical & Electrical Characteristics
Relative Output Flux vs. Forward Current @ 85°C

Forward Current vs. Forward Voltage @ 85°C

Relative Output Flux vs. Junction Temperature

Change in Voltage vs. Junction Temperature

Chromaticity Shift Characteristics

Change CIE_x vs. Junction Temperature (3000K, 80CRI)

Change CIE_y vs. Junction Temperature (3000K, 80CRI)

Optical Characteristics

Typical Spectrum

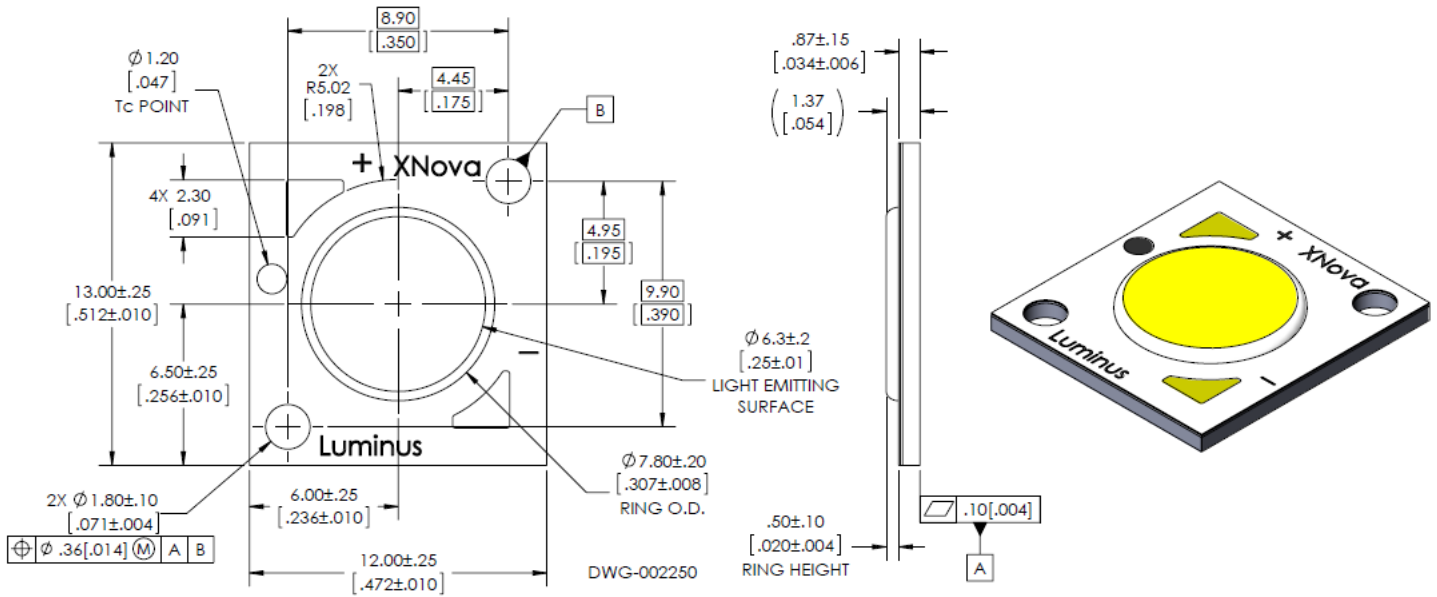
Typical Polar Radiation Pattern

Typical Angular Radiation Pattern

Mechanical Dimensions, CXM/CHM-6

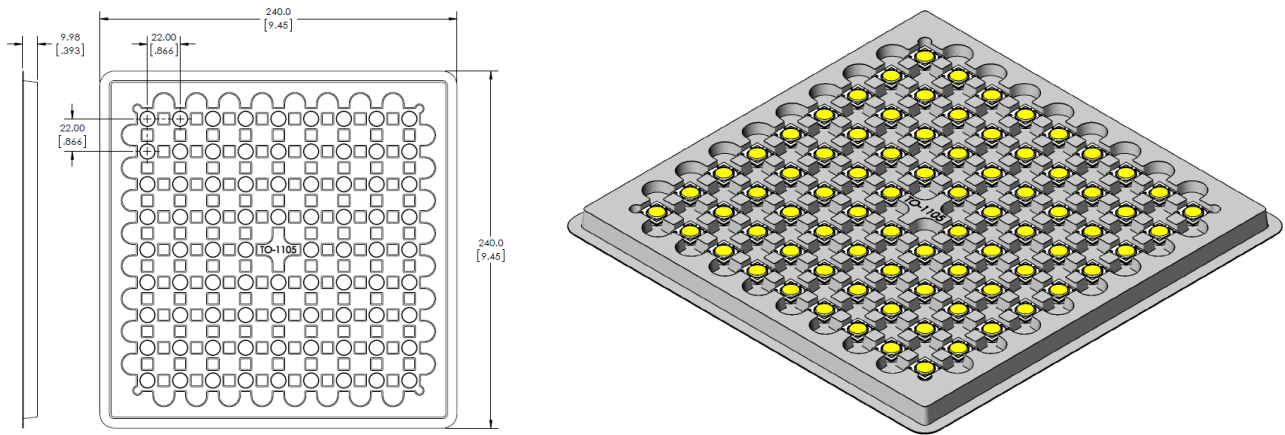

Shipping Container, CXM-6



Each bag is boxed for easier storage/stacking

Trays are sealed in an anti-static bag

5 trays are stacked together with one tray as a cover

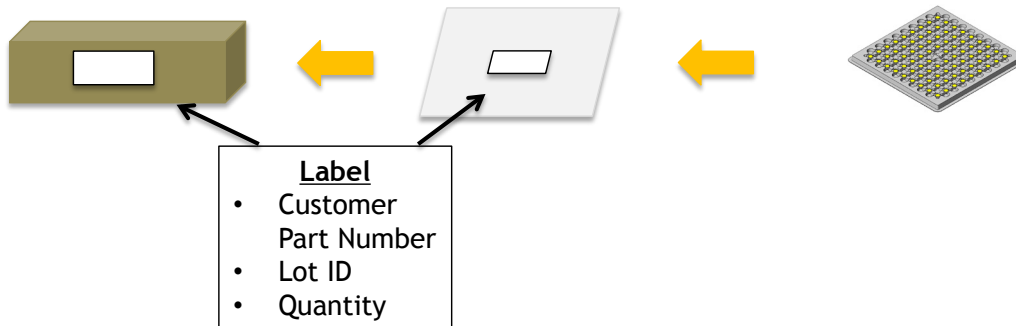

Mechanical Dimensions, CXM-7

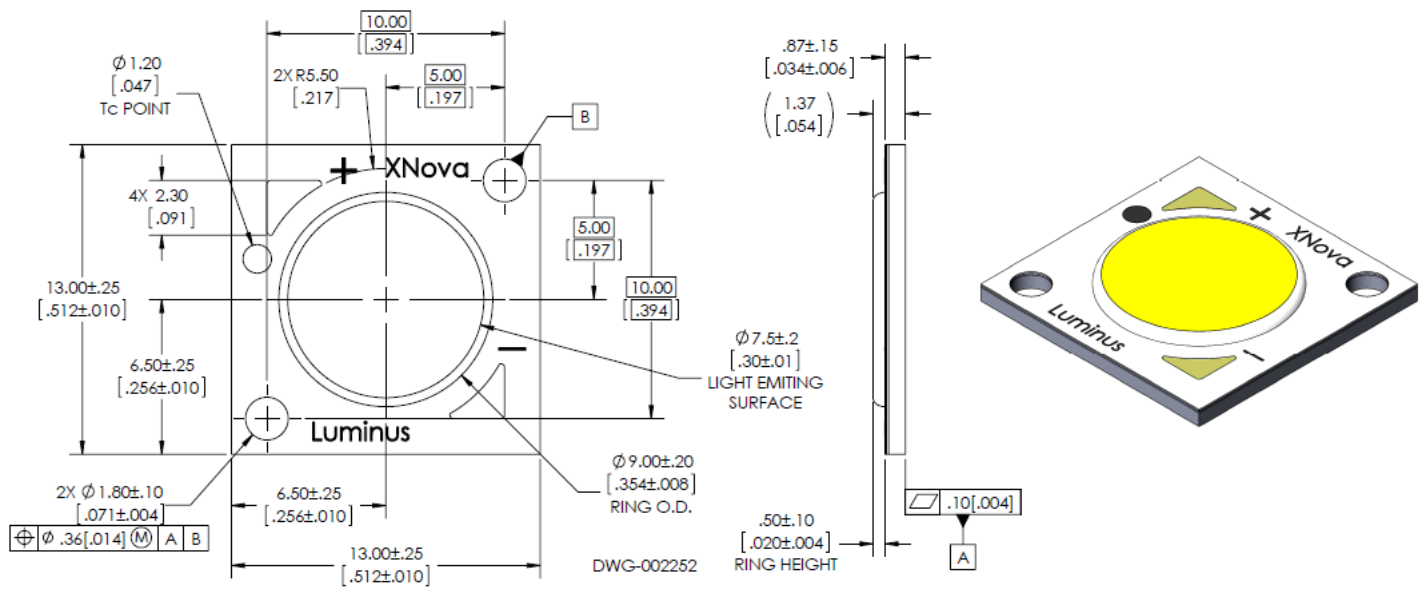

Shipping Container, CXM-7

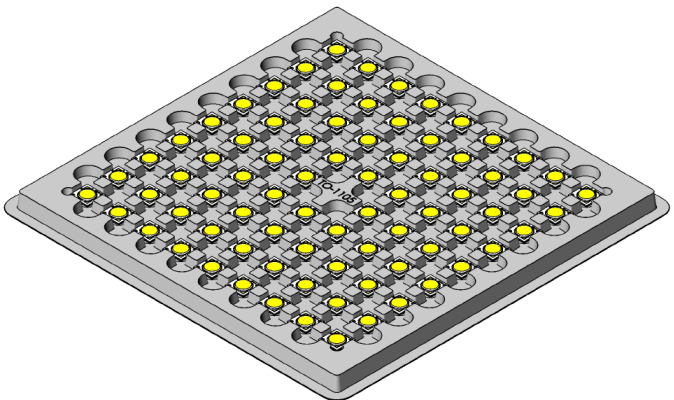
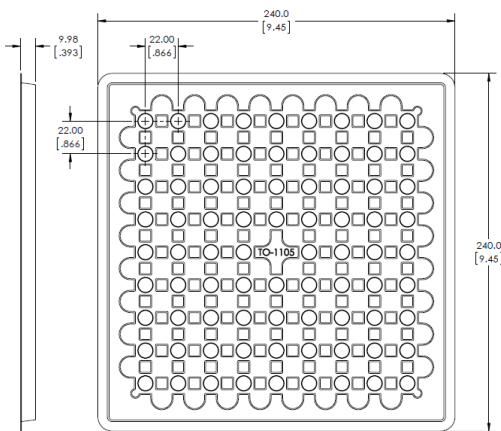

Each bag is boxed for easier storage/stacking

Trays are sealed in an anti-static bag

5 trays are stacked together with one tray as a cover

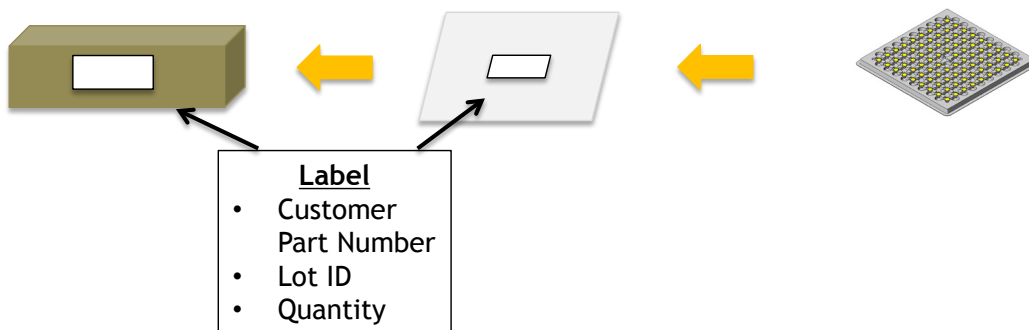

Mechanical Dimensions, CLM/CXM/CHM-9 (AA00)

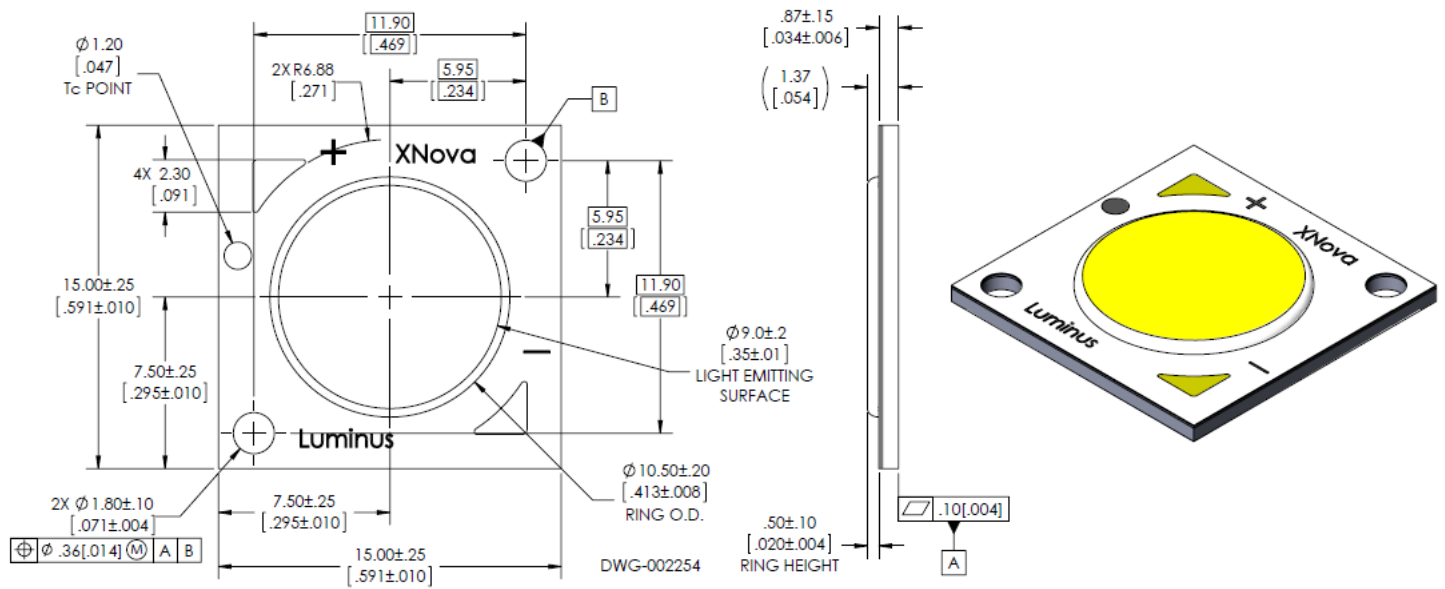

Shipping Container, CLM/CXM/CHM-9 (AA00)

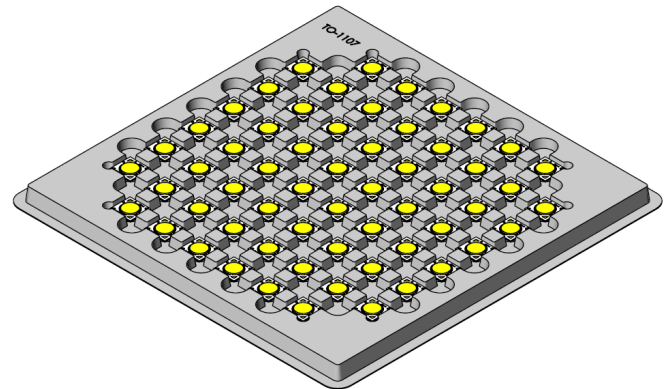
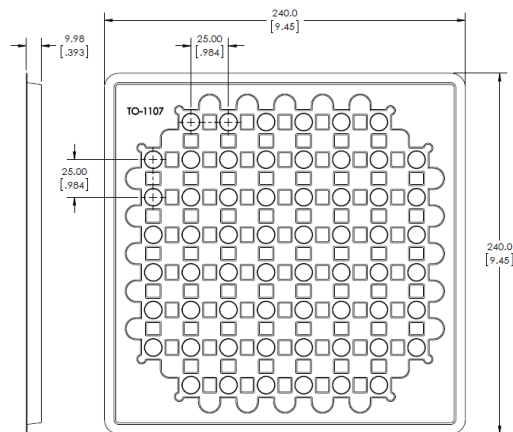

Each bag is boxed for easier storage/stacking

Trays are sealed in an anti-static bag

5 trays are stacked together with one tray as a cover

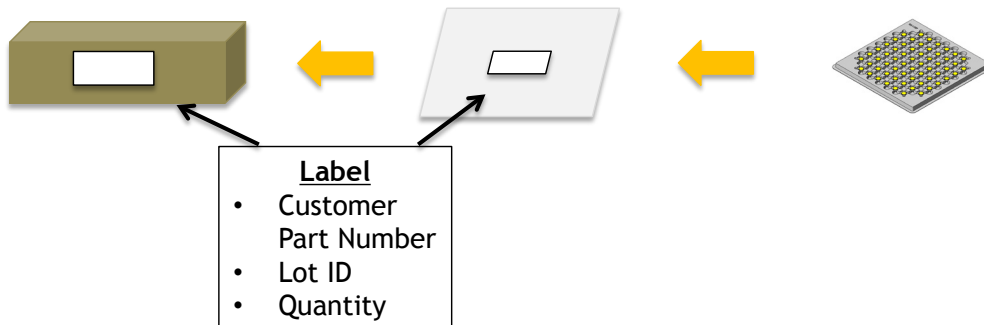

Mechanical Dimensions, CLM/CXM/CHM-9 (AC00)

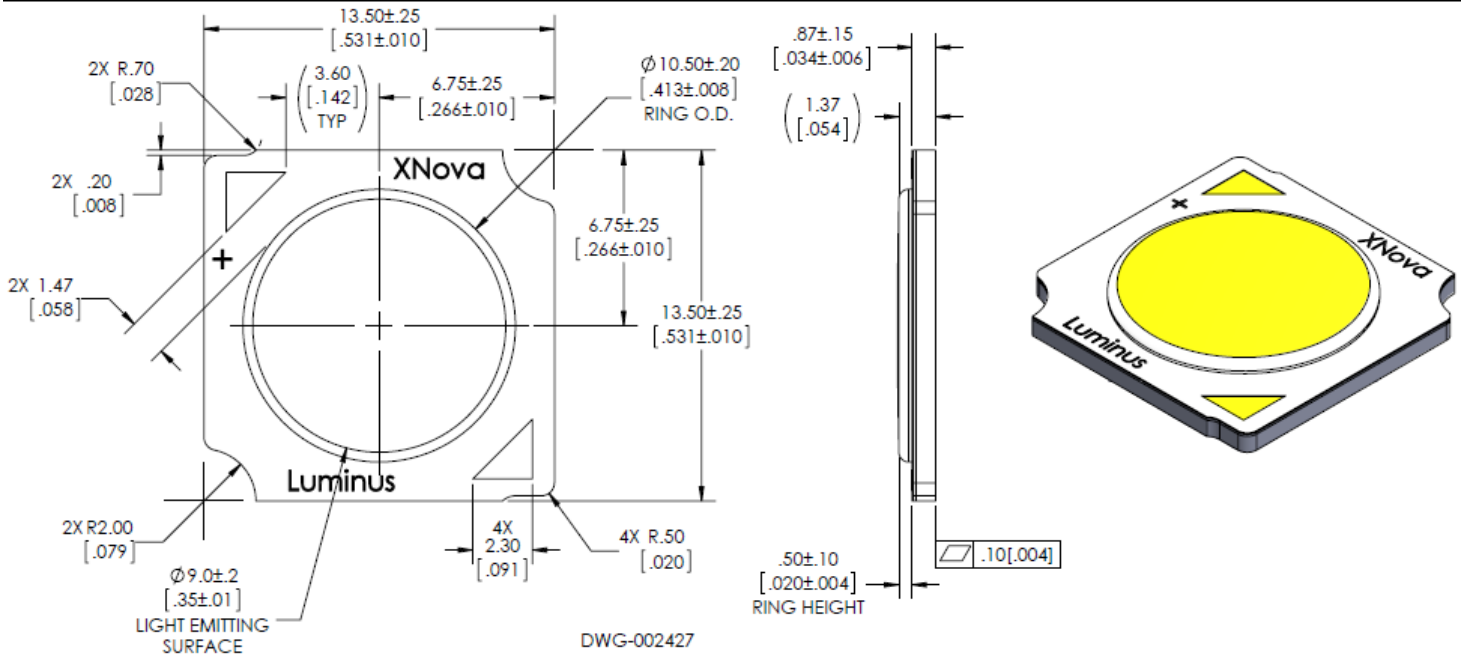

Shipping Container, CLM/CXM/CHM-9 (AC00)

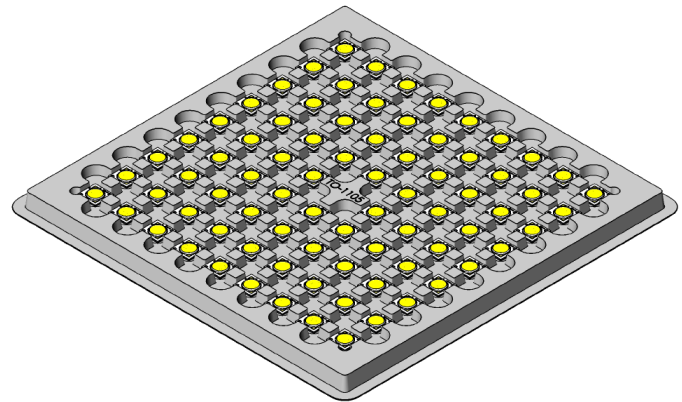
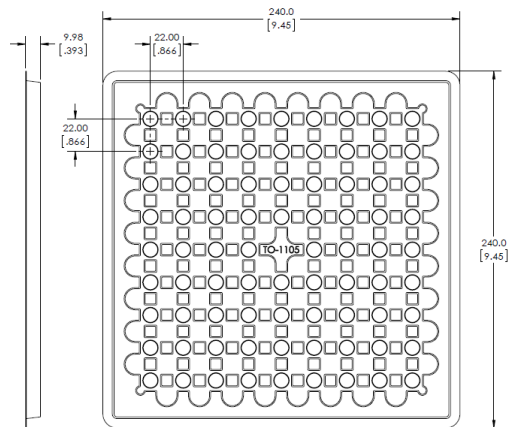

Each bag is boxed for easier storage/stacking

Trays are sealed in an anti-static bag

5 trays are stacked together with one tray as a cover

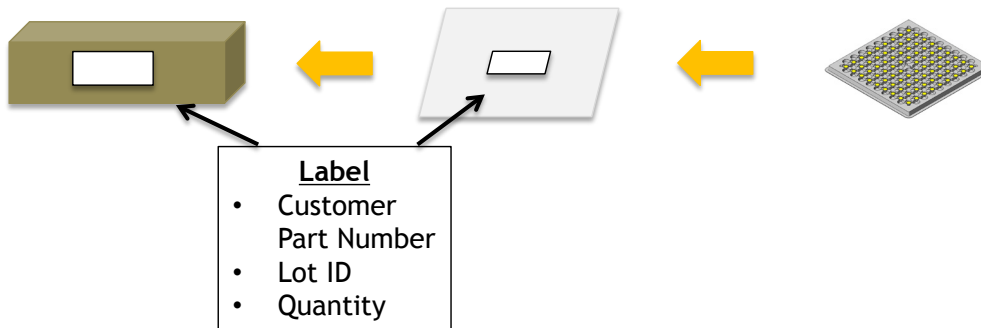

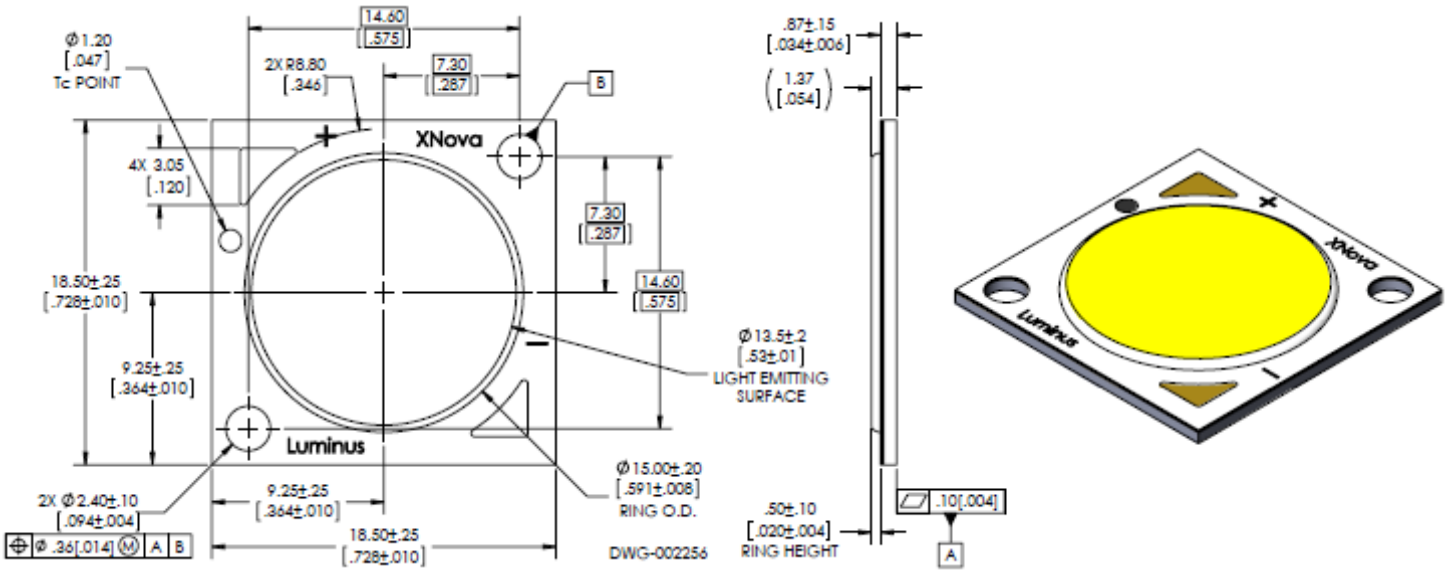
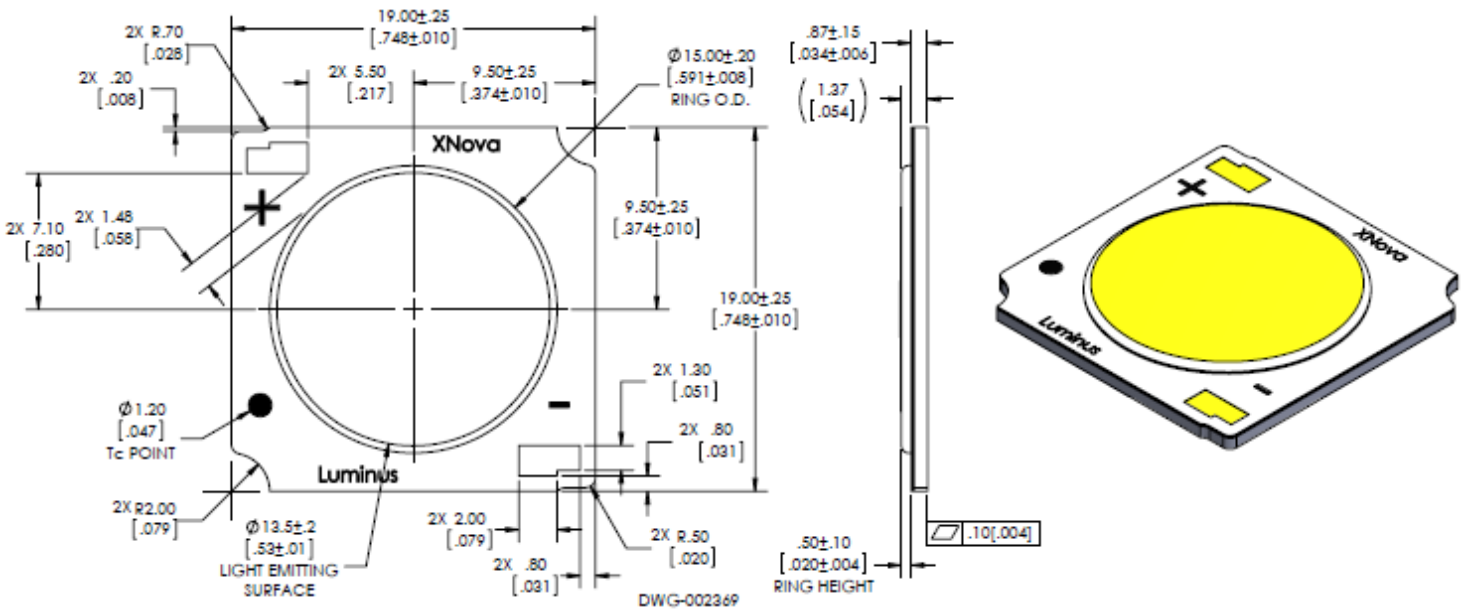
Mechanical Dimensions, CXM/CHM-14 (AA00)

Mechanical Dimensions CXM/CHM-14(AC00)

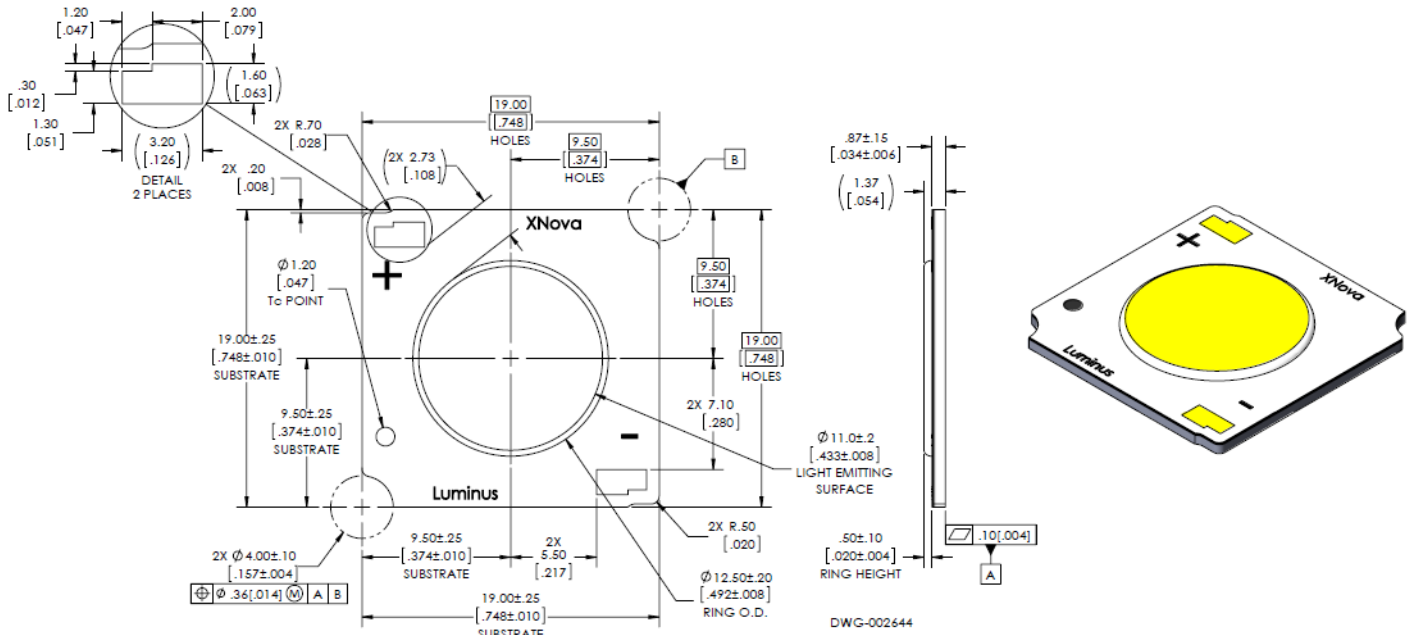
Mechanical Dimensions CXM-11 (AC00)

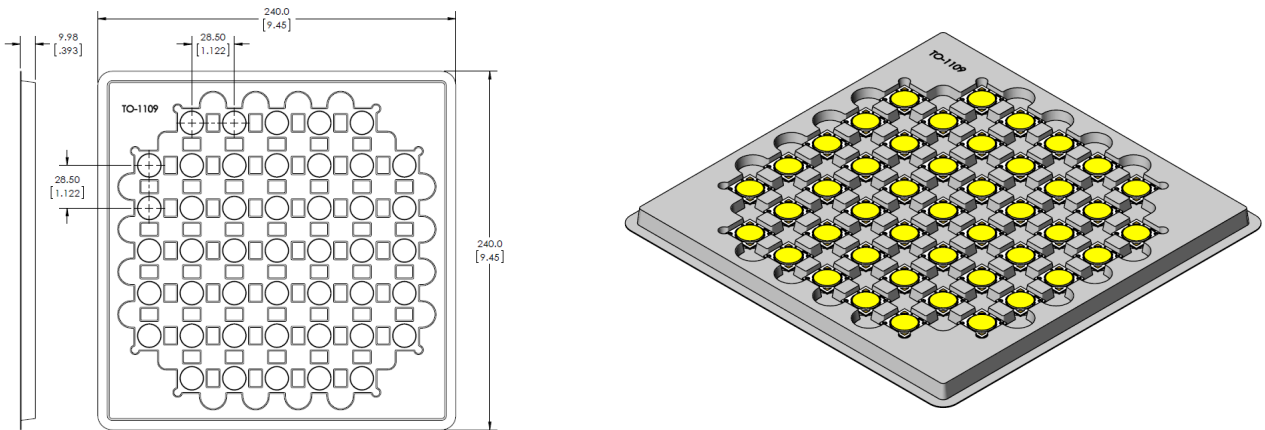

Shipping Container, CXM-11 & CXM/CHM-14 (AA00 and AC00)



Each bag is boxed for easier storage/stacking

Trays are sealed in an anti-static bag

5 trays are stacked together with one tray as a cover

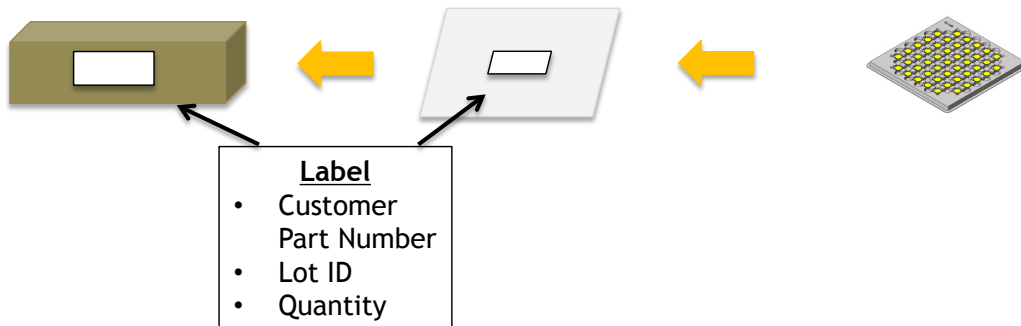

Mechanical Dimensions, CXM-18

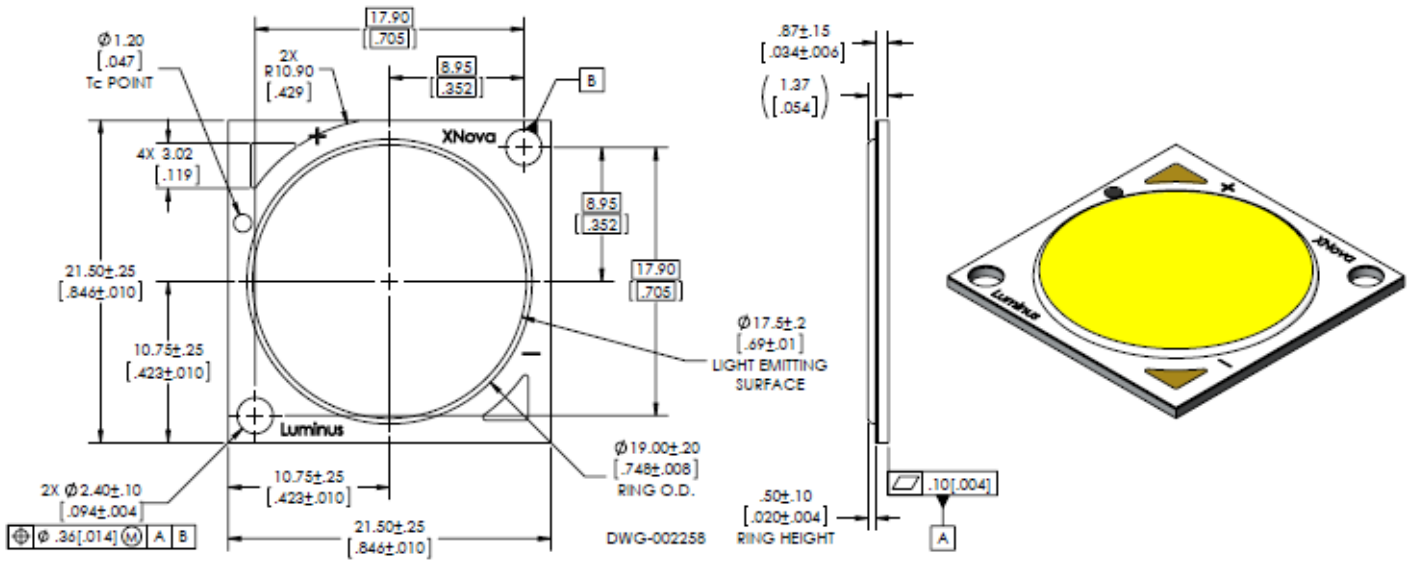

Shipping Container, CXM-18

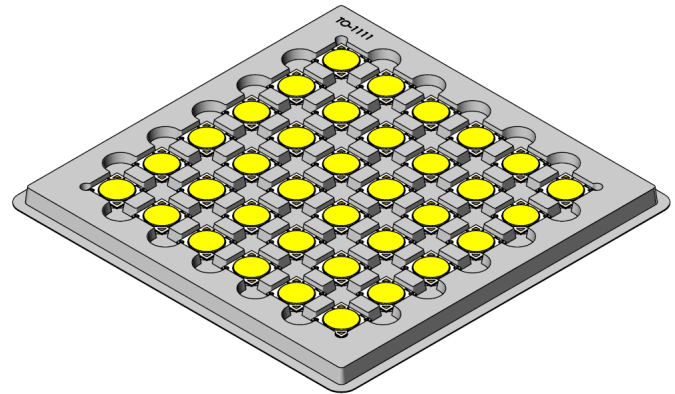
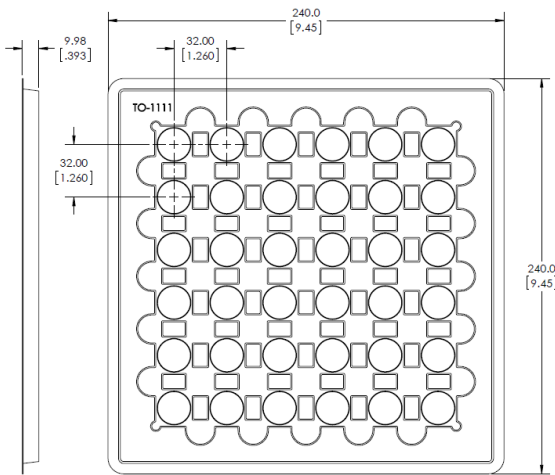

Each bag is boxed for easier storage/stacking

Trays are sealed in an anti-static bag

5 trays are stacked together with one tray as a cover

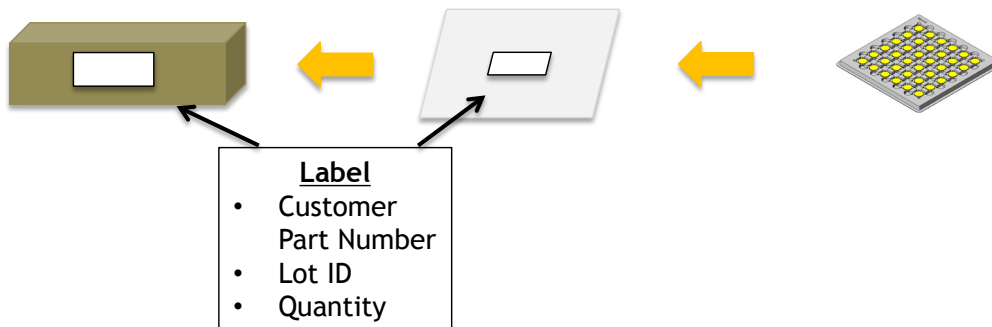

Mechanical Dimensions, CXM/CHM-22

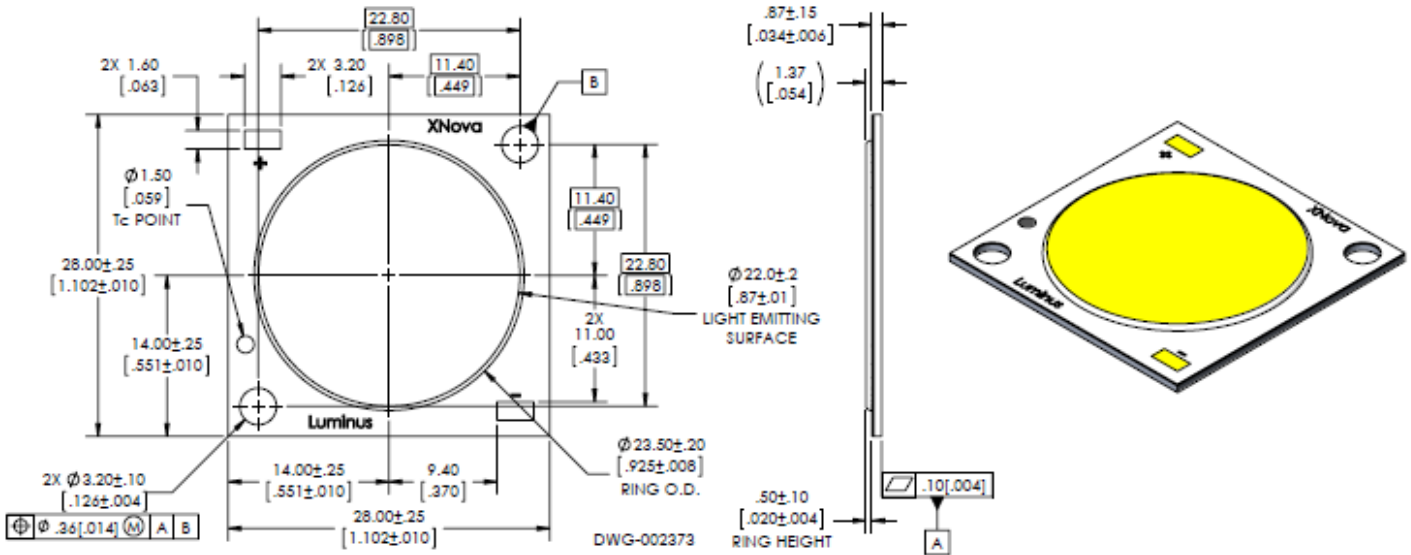

Shipping Container, CXM/CHM-22

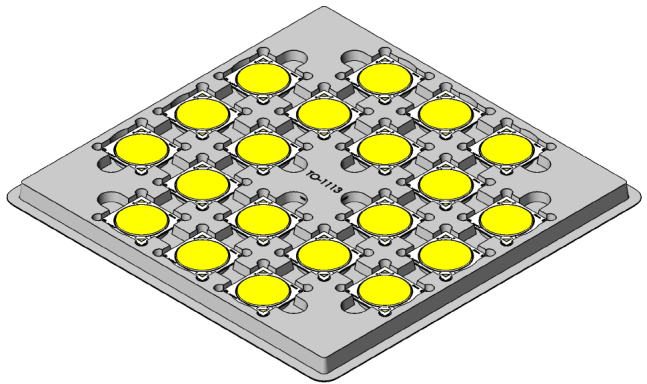
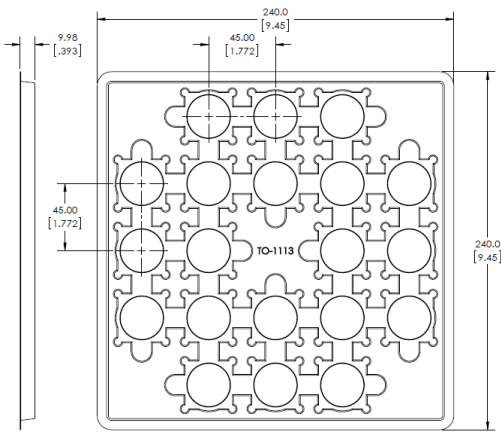

Each bag is boxed for easier storage/stacking

Trays are sealed in an anti-static bag

5 trays are stacked together with one tray as a cover

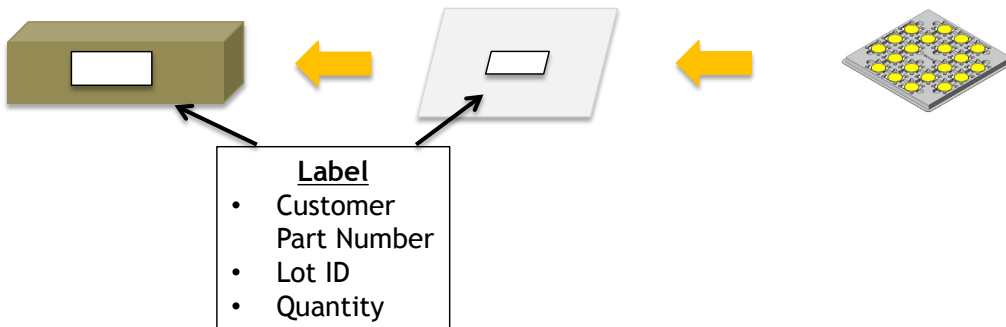

Handling Notes for Luminus COBs

Luminus products are designed for robust performance in general lighting application. However, care must be taken when handling and assembling the LEDs into their fixtures. To avoid damaging Luminus COBs please follow these guide lines.

The following is an overview of the application notes detailing some of the practices to follow when working with these devices. More detailed information is available on the Luminus web site at www.luminus.com.

General Handling

Devices are made to be lifted or carried with tweezers on two adjacent corners opposite the contact pads. At no time should the devices be handled by or should anything come in contact with the light emitting surface (LES) area. This area includes the yellow colored circular area and the ring surrounding it. There are electrical connections under the LES which if damaged will cause the device to fail.

In addition, the ring frame itself should not be used for moving, lifting or carrying the device. Also do not attach any optics or mechanical holders to the ring as it is not capable to handle the mechanical stress.

Static Electricity

Luminus COBs are electronic devices which can be damaged by electrostatic discharge (ESD). Please use appropriate measures to assure the devices do not experience ESD during their handling and or storage. ESD protection guidelines should be used at all times when working with Luminus COBs.

Storage: Luminus products are delivered in ESD shielded bags and should be stored in these bags until used.

Assembly: Individuals handling Luminus COBs during assembly should be trained in ESD protection practices. Assemblers should maintain constant conductive contact with a path to ground by means of a wrist strap, ankle straps, mat or other ESD protection system.

Transporting: When transporting the devices from one assembly area to another, ESD shielded carts and carriers should be used.

Electrical Contact

Luminus COBs are designed with contact pads on their top surface. These pads are clearly marked with + and – polarity. Wires can be soldered to the contact pads for electrical connections or other solderless connector products are available.

If wires are being soldered to the COB product, we recommend attaching these wires prior to mounting the devices to a heat sink. Please contact Luminus for specific recommendations on how to solder wires if not familiar with the standard practice. Luminus can also offer design recommendations for jigs to allow easily soldering multiple products in rapid succession.

Chemical Compatibility

The resin material used to form the LES can get hydrocarbons from the surrounding environment. As a result, certain chemical compounds are not recommended for use with the Luminus products. Use of these compounds can cause damage to the light output of the device and may permanently damage the device. Please refer to www.luminus.com for a list of the compounds not recommended for use with the Luminus COB products.

Thermal Interface Material (TIM)

Proper thermal management is critical for successful operation of any LED system. Excess operating temperature can reduce the light output of the device. And excessive heating can cause permanent damage to the device. Proper TIM material is a crucial component for effective heat transfer away from the LED during normal operation. Please refer to www.luminus.com for specific recommendations for TIM solutions.

X-ON Electronics

Largest Supplier of Electrical and Electronic Components

Click to view similar products for [High Power LEDs - White category:](#)

Click to view products by [Luminus Devices manufacturer:](#)

Other Similar products are found below :

[G42180-08](#) [B42180-08](#) [STW8Q2PA-R5-HA](#) [SZ5-M1-W0-00-V3/W2-AA](#) [LTPL-P00DWS57](#) [LZP-D0WW00-0000](#) [CLM-9-30-90-36-AC32-F4-3](#) [SZ5-M1-WW-C8-V1/V3-FA](#) [BXRC-27E2000-D-73](#) [BXRC-27G2000-D-73](#) [BXRC-30E1000-D-73](#) [BXRC-30G2000-D-73](#) [BXRC-40E1000-D-73](#) [BXRE-30G2000-B-73](#) [BXRE-30G2000-C-73](#) [BXRE-50C2001-C-74](#) [CXM-22-27-80-54-AC30-F4-3](#) [XHP50B-00-0000-0D0UH245G](#) [XHP50B-00-0000-0D0UH240G](#) [XHP50B-00-0000-0D0UG227H](#) [XHP50B-00-0000-0D0HJ245G](#) [MP-5050-8100-27-80](#) [MP-5050-6100-65-80](#) [MP-5050-6100-50-80](#) [MP-5050-6100-40-80](#) [MP-5050-6100-30-80](#) [CXM-22-30-80-54-AC30-F4-3](#) [LTW-2835SZK57](#) [BXEM-50C0000-0-000](#) [WW-WNA30TS-U1\(M1\)](#) [KW CSLPM2.CC-8L8M-4L8N](#) [KW CSLPM2.CC-8L8M-4O9Q](#) [KW DPLS32.SB-6H6J-E5P7-EG-Z264](#) [L1V1-507003V500000](#) [CXM-22-35-80-36-AC10-F3-3](#) [KW3 CGLNM1.TG-Z6QF6-EBVFFCBB46-DFGA](#) [JB5630AWT-H-H65EA0000-NZ000001](#) [XHP50B-00-0000-0D0UG430H](#) [CXM-22-35-90-54-AC40-F5-3](#) [CXM-22-35-80-54-AC40-F5-3](#) [OSM51206E1N-0.8T](#) [OSW43020C1C](#) [MP161611032290](#) [MP-1616-2103-50-90](#) [KW CULPM1.TG-Z6RF7-ebvFfcbB46-65G5](#) [KW DMLS33.SG-Z6M7-EBVFFCBB46-8E8G-700-S](#) [XPGDWT-B1-0000-00EEA](#) [XHP70B-00-0000-0D0BP450E](#) [KW DMLN33.SG-7J7K-EBVFFCBB46-8E8G-200-S](#) [ASMT-MW05-NMNS1](#)