

# Lux Series G5 CXM-14 COB Arrays White LED



## Features:

- High lumen output and efficacy typical
  - Over 3795 lm, 157LPW @ 3000K, 90CRI,  $T_j = 85^\circ\text{C}$
- CCT range 2400K, 2700K, 3000K, 3500K, 4000K, 5000K and 6500K
- 3 SDCM and 2 SDCM color binning standard
- Excellent optical emission uniformity and color over angle consistency
- Exceptional long term color stability
- Superior thermal conductivity for uniform heat spreading
- Environmentally friendly: RoHS and REACH compliant



## Applications

- Spotlights/Track Lights
- Downlights
- Shop Lighting
- Hospitality Lighting
- Architectural and Specialty
- Street Lighting
- Parking Lot and Area Lighting
- Tunnel Lighting

## Contents

Part Number Nomenclature	2
CCT, CRI & R9 Specification	. 2
Chromaticity Bin Structure	. 3
Ordering Part Numbers	. . . . . 4
Operating Characteristics	. . 6
Optical and Electrical Characteristics	. . . . . 7
Typical Spectrum	. . . . . 8
Radiation Pattern	. . . . . 8
Mechanical Dimension	. . . . . 9
Shipping Container	. . . . . 10
Label Information	. . . . . 10
Technology Review	. . . . . 11
Test Specifications	. . . . . 11
Handling Notes	. . . . . 12



### Part Number Nomenclature

All Luminus COB products are packaged and labeled with part numbers as outlined in the table on page 4. Luminus may include any smaller chromaticity bin that is contained in the larger bin as part of the ordered part. When shipped, each package will contain only a single flux and chromaticity bin. The part number designation is as follows:

Product Family	LES <sup>1</sup>	CCT <sup>2</sup>	Min. CRI <sup>3</sup>	Typical Voltage	Package Configurator <sup>4</sup>	Flux Bin	Chromaticity Bin
Chip on Board, Multi-die	14mm LES diameter	See Note 2 below	CRI See Table Below	Volts (V)	TC50	Lumens	See page 3 for bins

Notes:

1. Light Emitting Surface (LES) Diameter.
2. Correlated Color Temperature (CCT), NN nomenclature corresponds to the following:  
 24 = 2400K  
 27 = 2700K  
 30 = 3000K  
 35 = 3500K  
 40 = 4000K  
 50 = 5000K  
 65 = 6500K
3. Minimum Color Rendering Index (CRI).
4. TC is a standard substrate with sulfur resistance process; 5 means Lux Generation 5 COB products, 0 means a product with chromaticity on the BBL.
5. Luminus part numbers may be accompanied by prefixes or suffixes. The most common is the "Rev01" suffix indicating a part is fully released and carries a full warranty. These additional characters may appear on shipping labels, packing slips and invoices. In all cases the basic part number described above will always be included.

### CCT, CRI and R9 Values

Correlated Color Temperatures	XX Value	CRI	*R9
2400K, 2700K, 3000K, 3500K, 4000K, 5000K, 6500K	90	>90	>50
2700K, 3000K	95	>95	>85
3500K, 4000K, 5000K			>75

Note: R9 values have a tolerance of +/- 5%



## Chromaticity Bin Structure

Chromaticity Bins: 1931 CIE Color Space

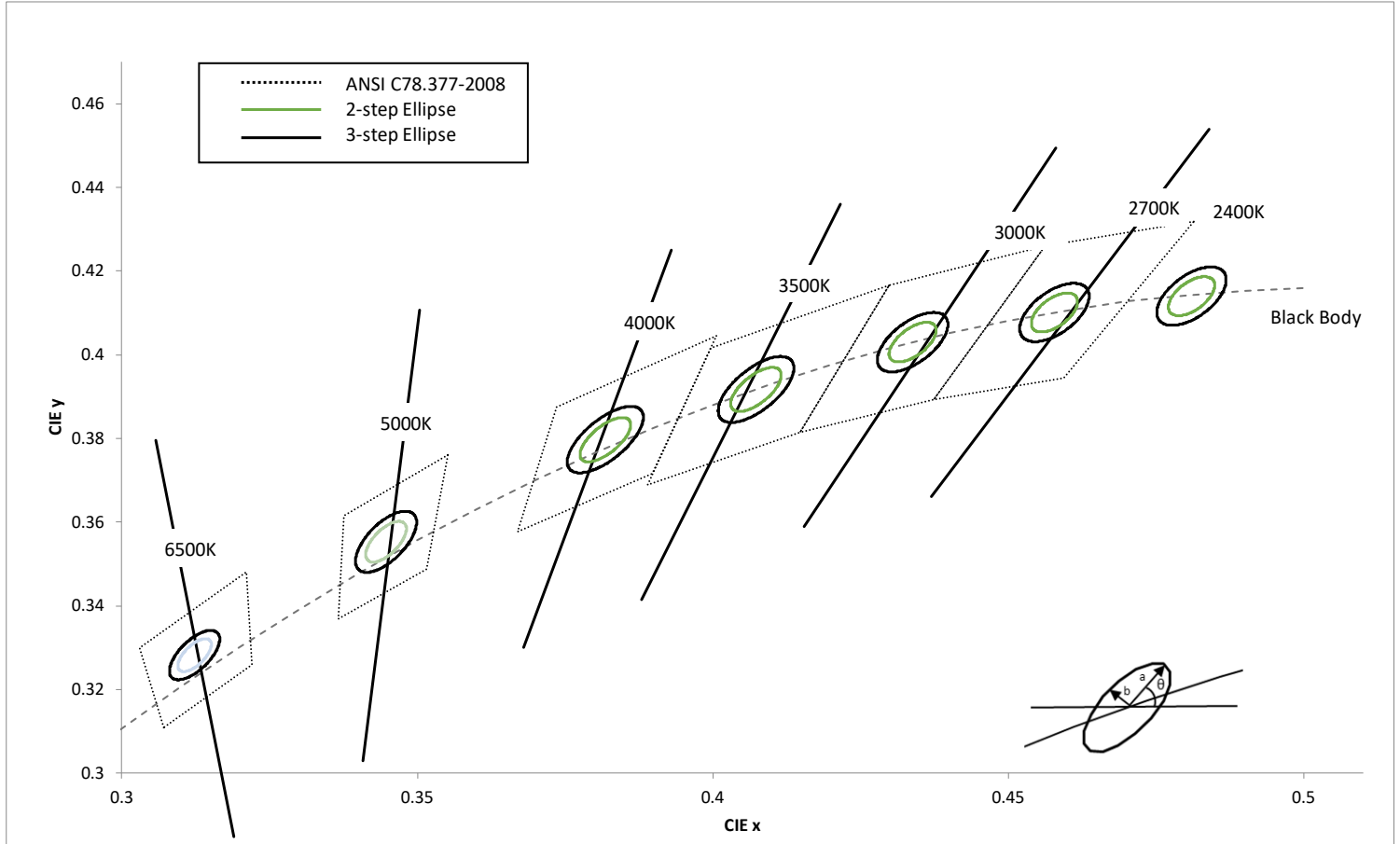

The following tables describe the chromaticity bin center points, the orientation angle for the MacAdam ellipse ( $\theta^\circ$ ), and the maximum radii for the ellipses. The ANSI Bin is provided for reference.

CCT	Center Point		Angle $\theta^\circ$	3-step Bin		2-step Bin	
	CIE <sub>x</sub>	CIE <sub>y</sub>		a	b	a	b
2400K	0.4810	0.4140	53.7	0.0081	0.0042	0.0054	0.0028
2700K	0.4578	0.4101	53.7	0.0081	0.0042	0.0054	0.0028
3000K	0.4338	0.4030	53.2	0.0083	0.0041	0.0056	0.0027
3500K	0.4073	0.3917	54.0	0.0093	0.0041	0.0062	0.0028
4000K	0.3818	0.3797	53.7	0.0094	0.0040	0.0063	0.0027
5000K	0.3447	0.3553	59.6	0.0082	0.0035	0.0055	0.0023
6500K	0.3123	0.3282	58.6	0.0067	0.0029	0.0045	0.0019

Note: Luminus maintains a +/- 0.005 tolerance on chromaticity (CIE<sub>x</sub> and CIE<sub>y</sub>) measurements



### Ordering Part Numbers - TC50

The following tables describe products with typical flux and minimum flux measured at 720mA and specified at  $T_j = 85^\circ\text{C}$ . The values at  $25^\circ\text{C}$  are calculated and shown for reference only.

CCT	Output Flux (lm)			Color Rendering Index (min.)	Ordering Part Number	
	Typ. ( $85^\circ\text{C}$ )	Min. ( $85^\circ\text{C}$ )	Calculated Typ. ( $25^\circ\text{C}$ )		3-step MacAdam Ellipse	2-step MacAdam Ellipse
2400K	3490	3245	3840	90	CXM-14-24-90-36-TC50-F6-3	CXM-14-24-90-36-TC50-F6-2
2700K	3730	3470	4100	90	CXM-14-27-90-36-TC50-F6-3	CXM-14-27-90-36-TC50-F6-2
	3405	3165	3745	95	CXM-14-27-95-36-TC50-F6-3	CXM-14-27-95-36-TC50-F6-2
3000K	3795	3530	4175	90	CXM-14-30-90-36-TC50-F6-3	CXM-14-30-90-36-TC50-F6-2
	3525	3280	3875	95	CXM-14-30-95-36-TC50-F6-3	CXM-14-30-95-36-TC50-F6-2
3500K	3960	3685	4360	90	CXM-14-35-90-36-TC50-F6-3	CXM-14-35-90-36-TC50-F6-2
	3545	3295	3900	95	CXM-14-35-95-36-TC50-F6-3	CXM-14-35-95-36-TC50-F6-2
4000K	3960	3685	4360	90	CXM-14-40-90-36-TC50-F6-3	CXM-14-40-90-36-TC50-F6-2
	3690	3430	4060	95	CXM-14-40-95-36-TC50-F6-3	CXM-14-40-95-36-TC50-F6-2
5000K	3930	3655	4320	90	CXM-14-50-90-36-TC50-F6-3	CXM-14-50-90-36-TC50-F6-2
	3720	3460	4090	95	CXM-14-50-95-36-TC50-F6-3	CXM-14-50-95-36-TC50-F6-2
6500K	3860	3590	4250	90	CXM-14-65-90-36-TC50-F6-3	CXM-14-65-90-36-TC50-F6-2

Note: Luminus maintains a +/- 6% tolerance on flux measurements.  
Luminus maintains a +/- 2% tolerance on CRI measurements.



### Chromaticity Bin Structure

Chromaticity Bins: 1931 CIE Color Space

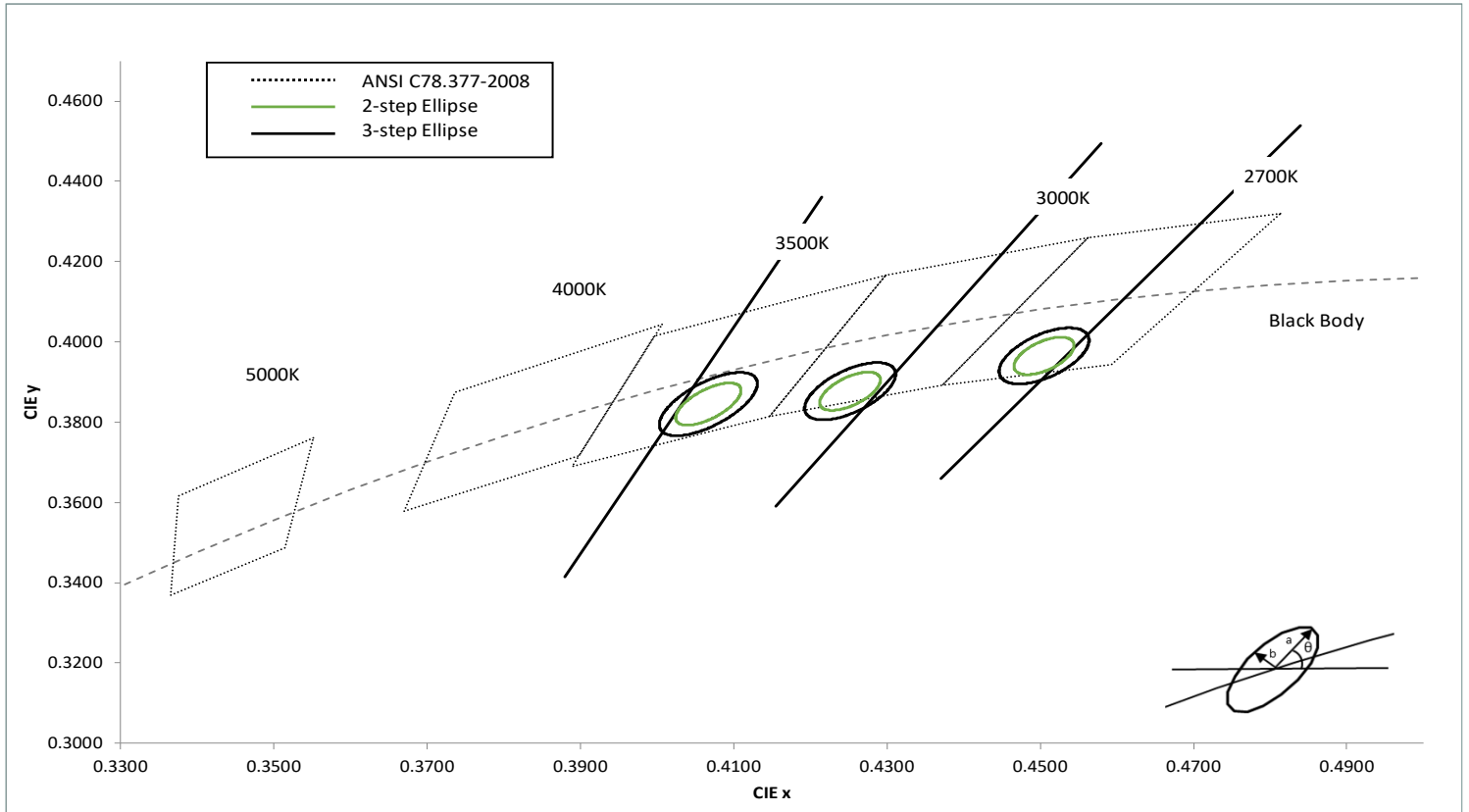

This table defines the chromaticity bin center points, the orientation angle for the MacAdam ellipse ( $\theta^\circ$ ), and the maximum radii for the ellipses. The ANSI Bin is provided in the above graph for reference.

CCT	Center Point		Angle	3-step Bin		2-step Bin	
	CIE <sub>x</sub>	CIE <sub>y</sub>	$\theta^\circ$	a	b	a	b
2700K	0.4505	0.3965	53.7	0.0081	0.0042	0.0054	0.0028
3000K	0.4252	0.3877	53.6	0.0083	0.0041	0.0056	0.0027
3500K	0.4067	0.3845	54.0	0.0093	0.0041	0.0061	0.0028

Note: Luminus maintains a +/- 0.005 tolerance on chromaticity (CIE<sub>x</sub> and CIE<sub>y</sub>) measurements

### Ordering Part Numbers - TC52 Sensus (BBBL)

The following tables describe products with typical flux and minimum flux measured at 720mA and specified at  $T_j = 85^\circ\text{C}$ . The values at  $25^\circ\text{C}$  are calculated and shown for reference only.

CCT	Output Flux (lm)			Color Rendering Index (min.)	Ordering Part Number	
	Typ. ( $85^\circ\text{C}$ )	Min. ( $85^\circ\text{C}$ )	Calculated Typ. ( $25^\circ\text{C}$ )		3-step MacAdam Ellipse	2-step MacAdam Ellipse
2700K	3605	3355	3970	90	CXM-14-27-90-36-TC52-F6-3	CXM-14-27-90-36-TC52-F6-2
3000K	3680	3425	4050	90	CXM-14-30-90-36-TC52-F6-3	CXM-14-30-90-36-TC52-F6-2
3500K	3775	3510	4150	90	CXM-14-35-90-36-TC52-F6-3	CXM-14-35-90-36-TC52-F6-2

Note: Luminus maintains a +/- 6% tolerance on flux measurements.  
Luminus maintains a +/- 2% tolerance on CRI measurements.



### Operating Characteristics<sup>1</sup>

Parameter	Symbol	Minimum	Typical	Maximum	Unit
Forward Current <sup>2</sup>	$I_f$		720	990	mA
Forward Voltage <sup>3</sup>	$V_f$	31.5	33.4	34.7	V
Power			24.1	34.3	W
Operating Case Temperature	$T_c$			105	°C
Light Emitting Surface Diameter	LES		14.5		mm
Thermal Resistance (junction-to-case)	$\Theta_{jc}$		0.23		°C/W
Junction Temperature	$T_j$			140	°C
Viewing Angle			120		Degree

**Notes:**

1. Device measurements are at  $T_j=85^\circ\text{C}$ .
2. To prevent damage refer to operating conditions and derating curves for appropriate maximum operating conditions
3. Voltage is rated at typical forward current. For voltage at higher drive current, refer to performance graphs.
4. Device operation not recommended at drive currents less than 10% of the typical value
5. Caution must be taken not to stare at the light emitted from these LEDs. Under special circumstances, the high intensity could damage the eye.
6. All product operating specifications are subject to change without advance notice.



### Optical & Electrical Characteristics

Relative Output Flux vs. Forward Current @ 85°C

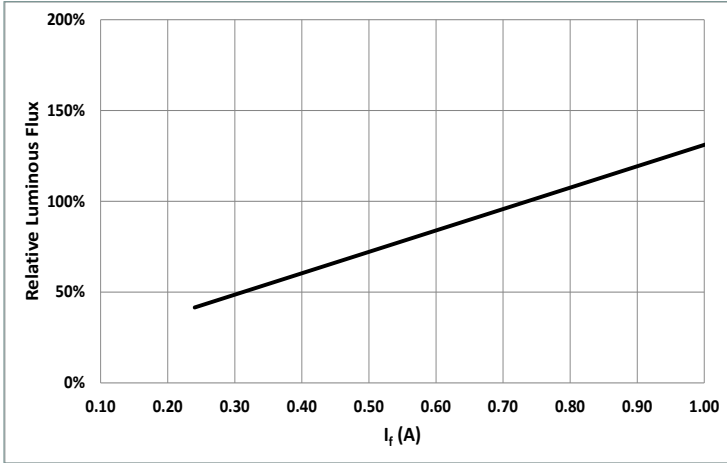

Forward Current vs. Forward Voltage @ 85°C

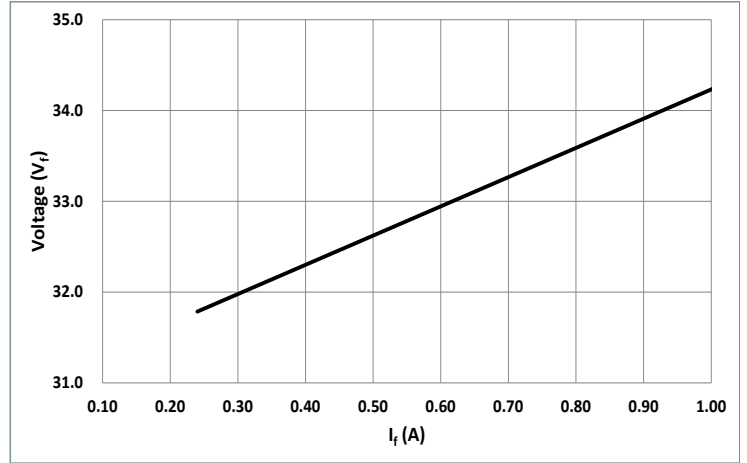

Relative Output Flux vs. Junction Temperature

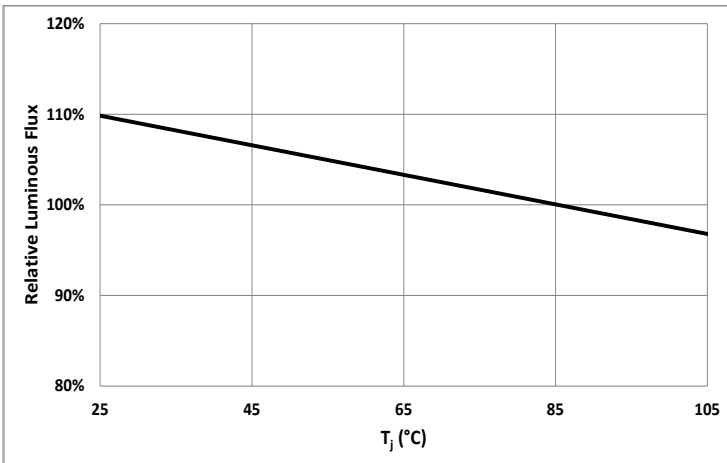

Change in Voltage vs. Junction Temperature

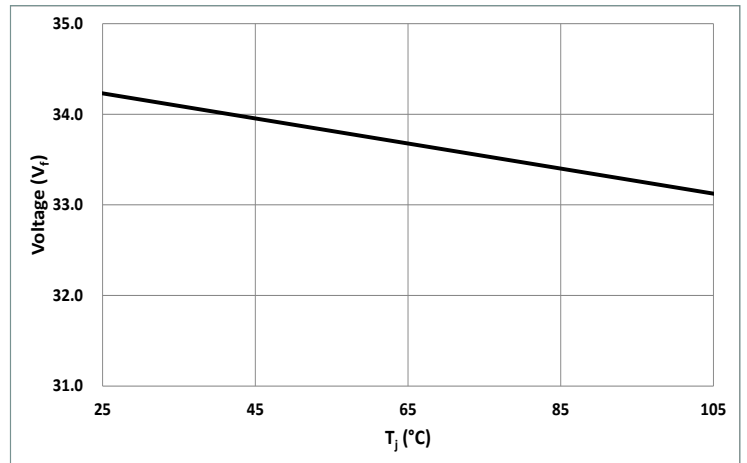

Change in CIE\_x/y vs. Junction Temp. (3000K, 90CRI)

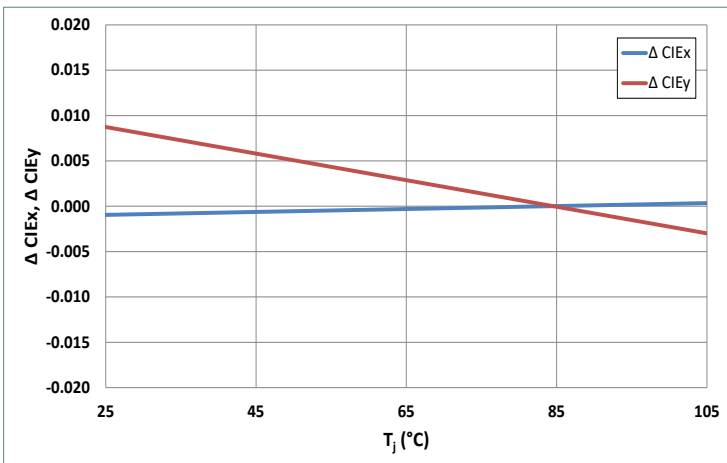

Change in CIE\_x/y vs. Forward Current (3000K, 90CRI)

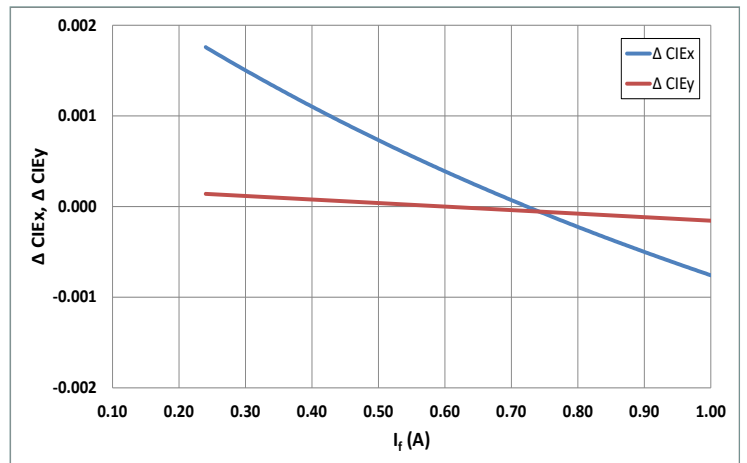



### Typical Spectrum

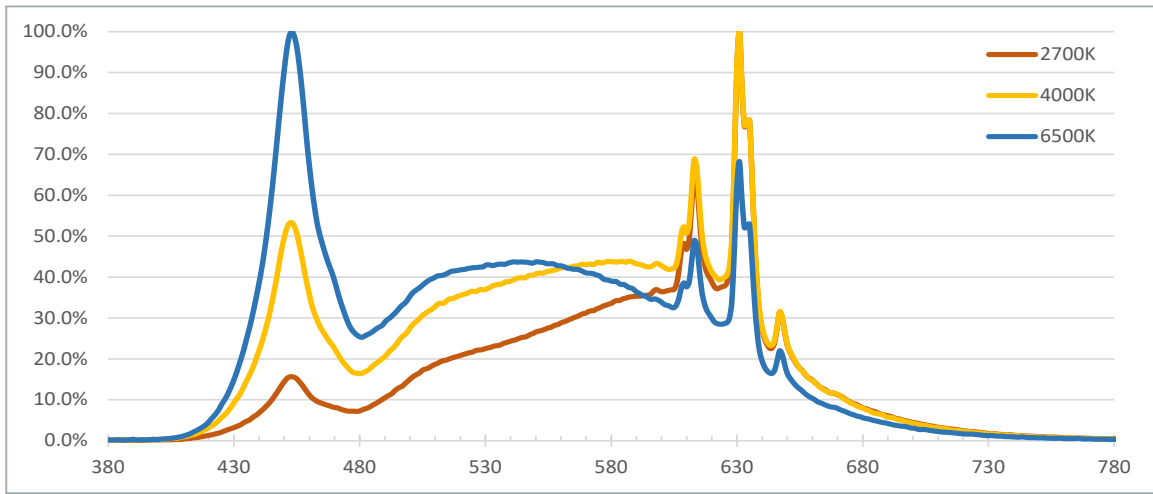

### Radiation Pattern

Typical Polar Radiation Pattern

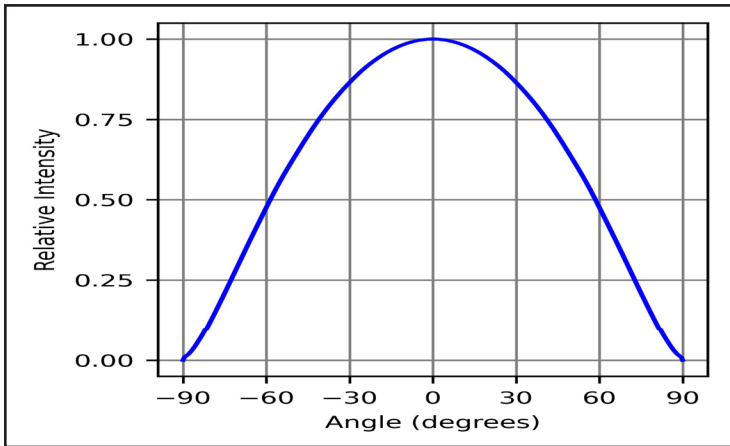

Typical Angular Radiation Pattern

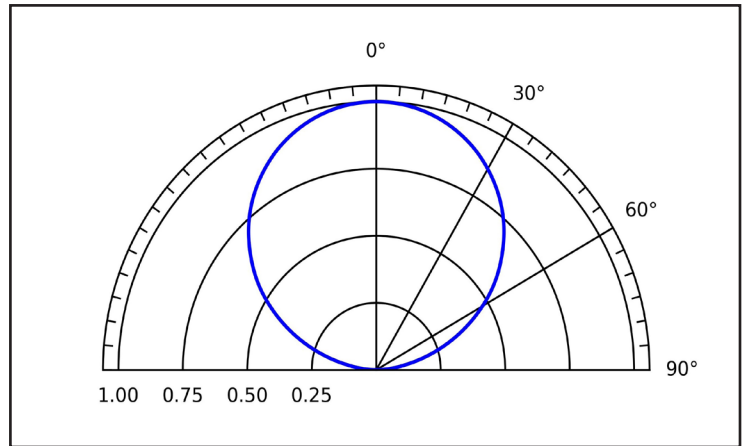





### Mechanical Dimensions - TC50

Note: Unless otherwise specified, tolerance is  $\pm 0.3\text{mm}$

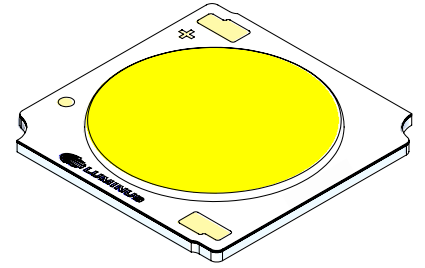
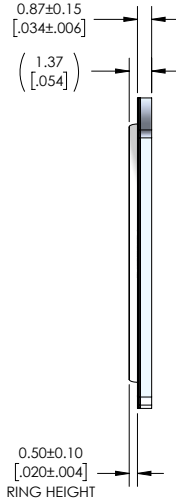
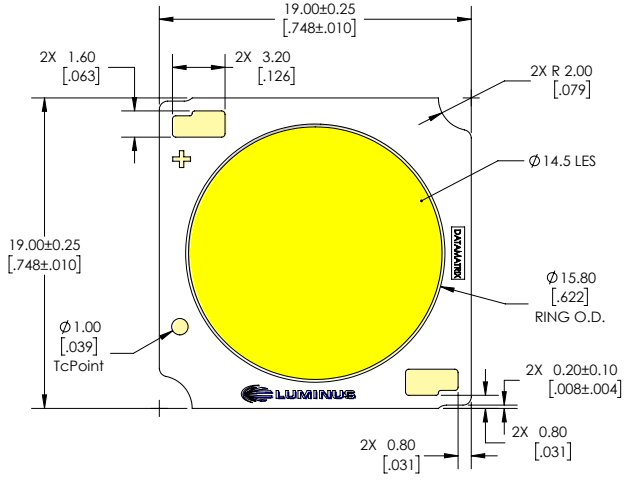



### Shipping Container



Package model -- for illumination

Note: 45 pcs per tray and 5 trays are stacked together to be sealed in an anti-static bag.



Note: The anti-static bag is boxed for easier storage, 225pcs per box.

### Label Information

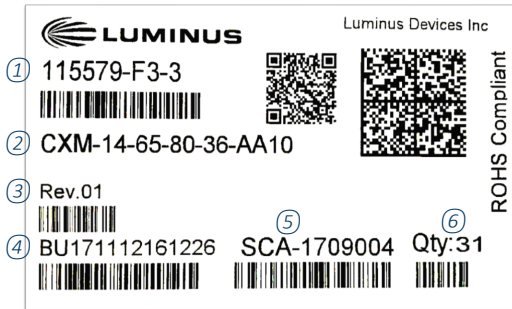

Label model -- for illustration only

Notes:

- ① Manufacturer part number, flux bin and chromaticity bin
- ② Customer part number
- ③ Rev.01 indicates a fully released product
- ④ Box ID
- ⑤ Production ID
- ⑥ Total number of units in a box



## Technology Overview

Luminus Chip-on-Board (COB) LED series have consistently delivered the highest lumen performance with the best color quality of any COB supplier. Driving performance enhancements through more than 5 generations of COB products has provided Luminus a comprehensive understanding of the lighting market for directional sources positioning Luminus as the COB manufacturer of choice for the most discriminating lighting manufacturers.

### Reliability

Designed from the ground up, the Luminus COB LED is one of the most reliable light sources in the world today.

### UL and IEC Recognized Compliance

Luminus COB arrays are tested in accordance with ANSI/UL 8750 to ensure safe operation for their intended applications. Further, Luminus maintains IEC-62031 safety ratings on all COB products.

### REACH & RoHS Compliance

All LED products manufactured by Luminus are REACH and RoHS compliant and free of hazardous materials, including lead and mercury.

## Test Specifications

Every Luminus LED is fully tested to ensure it meets the high quality standards customers have come to expect from Luminus' products.

### Traceability

Each Luminus COB LED is marked with a 2D bar code that contains a unique serial number. With this serial number, Luminus has the ability to provide customers with actual test data measurements for a specific LED. In addition, the 2D bar code is linked to manufacturing date codes that enables traceability of production processes and materials.

### Testing Temperature

Luminus COB products are measured at temperatures typical for the LED operating in the fixture. Each device is tested at 85°C junction temperature eliminating the need to scale data sheet specifications to real world situations.

### Chromaticity Bin Range

Chromaticity binning delivers color consistency for every order. Standard products are delivered with a 3-step MacAdam ellipse. This ensures color performance matching in the application. For the most demanding application, Luminus is one of only a few companies that can provide a 2 SDCM bin distribution. These tightly controlled, small distribution bins provide customers predictable, repeatable colors.



## Handling Notes

Luminus products are designed for robust performance in general lighting application. However, care must be taken when handling and assembling the LEDs into their fixtures. To avoid damaging Luminus COBs please follow these guidelines.

The following is an overview of the application notes detailing some of the practices to follow when working with these devices. More detailed information is available on the Luminus web site at [www.luminus.com](http://www.luminus.com).

### General Handling

Devices are made to be lifted or carried with tweezers on two adjacent corners opposite the contact pads. At no time should the devices be handled by or should anything come in contact with the light emitting surface (LES) area. This area includes the yellow colored circular area and the ring surrounding it. There are electrical connections under the LES which if damaged will cause the device to fail. In addition, the ring frame itself should not be used for moving, lifting or carrying the device. Also do not attach any optics or mechanical holders to the ring as it is not capable to handle the mechanical stress.

### Storage Condition

Please follow the conditions below.

Before opened	Temperature 5~30°C, relative humidity less than 60%.
After opened	Temperature 5~30°C, relative humidity less than 60%. After opening, LED should be kept in an aluminum moisture proof bag with a moisture absorbent material
Avoid Corrosive gas	Avoid exposing to air with corrosive gas. If exposed, electrode surface would be damaged, which may affect soldering. More detailed information is available on the Luminus Applications Resources web pages.

### Static Electricity

Luminus COBs are electronic devices which can be damaged by electrostatic discharge (ESD). Please use appropriate measures to assure the devices do not experience ESD during their handling and or storage. ESD protection guidelines should be used at all time when working with Luminus COBs.

Storage	Luminus products are delivered in ESD shielded bags and should be stored in these bags until used
Transporting	When transporting the devices from one assembly area to another, ESD shielded carts and carriers should be used
Assembly	Individuals handling Luminus COBs during assembly should be trained in ESD protection practices. Assemblers should maintain constant conductive contact with a path to ground by means of a wrist strap, ankle straps, mat or other ESD protection system



### Chemical Compatibility

The resin material used to form the LES can get hydrocarbons from the surrounding environment. As a result, certain chemical compounds (H<sub>2</sub>SO<sub>4</sub>, H<sub>2</sub>S, SO<sub>2</sub>, NH<sub>3</sub>, H<sub>3</sub>PO<sub>4</sub>, etc.) are not recommended for use with the Luminus products. Use of these compounds can cause damage to the light output of the device and may permanently damage the device. Please refer to the table below for a list of the compounds not recommended for use with the Luminus COB products.

Common Chemicals Know to Adversely Affect Luminus Devices		
Acetates	Ethers	Potassium hydroxide
Acetic acid	Cl, F or Br containing compounds	Siloxanes
Acrylates	Liquid hydrocarbons	Sodium Hydroxide
Aldehydes	Hydrochloric Acid	Sulfur compounds
Aldehydes	Ketones	Sulfuric Acid
Amines	Nitric Acid	Toluene
Benzene	Phosphoric acid	Xylenes
Dienes		

### Thermal Interface Material (TIM)

Proper thermal management is critical for successful operation of any LED system. Excess operating temperature can reduce the light output of the device. Excessive heating can cause permanent damage to the device. Proper TIM material is a crucial component for effective heat transfer away from the LED during normal operation. Please refer to [www.luminus.com](http://www.luminus.com) for specific recommendations for TIM solutions.

Please refer to <https://www.luminus.com/resource/application-notes> for more application note information.

## X-ON Electronics

Largest Supplier of Electrical and Electronic Components

*Click to view similar products for [High Power LEDs - White category](#):*

*Click to view products by [Luminus Devices manufacturer](#):*

Other Similar products are found below :

[LTW-K140SZR40](#) [LTPL-P00DWS57](#) [LTW-K140SZR30](#) [LZP-D0WW00-0000](#) [JK2835AWT-00-0000-000B0HL227E-BLK](#) [LTW-K140SZR57](#) [LTW-K140SZR27](#) [BXRC-35E10K0-D-73](#) [MP-5050-6100-65-80](#) [KW CSLPM2.CC-8L8M-4L8N](#) [KW CSLPM2.CC-8L8M-4O9Q](#) [KW DPLS32.SB-6H6J-E5P7-EG-Z264](#) [L1V1-507003V500000](#) [BXRE-27E1000-C-83](#) [BXRE-27G0800-D-83](#) [BXRE-27G2000-B-83](#) [BXRE-50C2001-C-84](#) [BXRH-35S1001-B-73](#) [BXRH-30E0300-B-83](#) [BXRH-30E1000-G-83](#) [115780](#) [LM1311D4W-12B4C12\(Ra4\)-DS](#) [ELJU\(9\)-K40M3-0LTHE-R4000](#) [ELJU\(9\)-K40M3-0LTHE-R3000](#) [LM1311D4W-12B2C24\(Ra4\)-DS](#) [KW2 CFLNM2.TK-D2D9-4L07M0-SC6B](#) [XEGAWT-H2-0000-000-00000UT122G](#) [XHP35B-H0-0000-0D0ZA230G](#) [XHP35B-H0-0000-0D0ZA440G](#) [XHP35B-H0-0000-0D0ZA227G](#) [XHP35B-H0-0000-0D0ZA235G](#) [CTM-9-4018-90-36-TWD6-F3-3](#) [CVM-32-56-95-54-AC00-F2-2](#) [SST-12-W65S-A120-H4652](#) [CXM-4-24-90-18-AC40-F5-2](#) [CXM-4-22-90-18-AC40-F5-2](#) [LM002H384W-7B3C12\(Ra5\)\(ANSI-2700K\)](#) [LM002H384W-9B4C12\(Ra2\)\(ANSI-2700K\)](#) [LM002H384W-7B3C12\(Ra7\)\(ANSI-2700K\)](#) [LM002H384W-9B4C12\(Ra2\)\(ANSI-3000K\)](#) [LM002H384W-9B4C12\(Ra4\)-S\(ANSI-3500K\)](#) [LM002H384W-9B4C12\(Ra5\)\(ANSI-4000K\)](#) [LM002H384W-7B3C12\(Ra2\)-S\(ANSI-3000K\)](#) [LM002H384W-7B3C12\(Ra5\)\(ANSI-4000K\)](#) [LM002H384W-7B3C12\(Ra7\)\(ANSI-4000K\)](#) [HL-LM002H384W-5B2C5\(Ra4\)\(ANSI-3000K\)](#) [HL-LM002H384W-7B1C18\(Ra4\)\(ANSI-6000K\)](#) [LM002H384W-7B3C12\(Ra5\)\(ANSI-3500K\)](#) [HL-LM002H384W-5B2C5\(Ra4\)\(ANSI-4000K\)](#) [HL-LM002H384W-5B2C5\(Ra4\)\(ANSI-6000K\)](#)