

SBT-70 LEDs

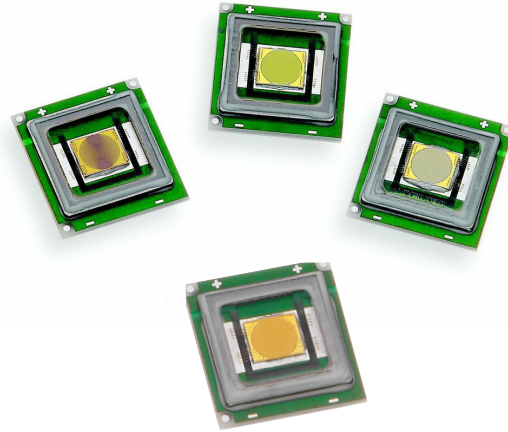

Table of Contents

Technology Overview2

White Flux Bins.3

White Chromaticity Bins4

RGB Flux & Wavelength Bins 7

Product Shipping & Labeling Information.8

White Optical & Electrical Characteristics9

RGB Optical & Electrical Characteristics 12

Thermal Resistance 17

Mechanical Dimensions . . 18

Ordering Information 20

Features:

- Extremely high optical output from a 7 mm² circular emitter:
 - Up to 2,000 white lumens
 - Over 880 red Lumens
 - Over 1,900 green lumens
 - Over 425 blue lumens
- Round emitting aperture provides most efficient match to circular optical systems and narrow beam projectors
- Unencapsulated die with low profile protective window optimizes optical coupling in etendue-limited applications
- High thermal conductivity package - junction to case thermal resistance of only 0.7 °C/W
- Variable drive current: 1 A to 10.5 A
- High CRI at tungsten white and daylight white color temperatures for natural lighting
- Environmentally friendly: RoHS compliant

Applications

- Architectural and Entertainment Lighting
- Fiber-coupled Illumination
- Medical Lighting
- Machine Vision
- Microscopy
- Spot Lighting

Technology Overview

Luminus Big Chip LEDs™ benefit from a suite of innovations in the fields of LED die technology, packaging and thermal management. These breakthroughs allow illumination engineers and designers to achieve solutions that are high brightness and high efficiency.

Luminus Technology

Luminus' technology enables large area LED chips with uniform brightness over the entire LED chip surface. The optical power and brightness produced by these large monolithic chips enable solutions which replace arc and halogen lamps where arrays of traditional high power LEDs cannot.

Packaging Technology

Thermal management is critical in high power LED applications. With a thermal resistance from junction to case of 0.7° C/W, Luminus SBT-70 LEDs have the lowest thermal resistance of any LED on the market. This allows the LED to be driven at higher current densities while maintaining a low junction temperature, thereby resulting in brighter solutions and longer lifetimes.

Reliability

Designed from the ground up, Luminus Big Chip LEDs are one of the most reliable light sources in the world today. Big Chip LEDs have passed a rigorous suite of environmental and mechanical stress tests, including mechanical shock, vibration, temperature cycling and humidity, and have been fully qualified for use in extreme high power and high current applications. With very low failure rates and median lifetimes that typically exceed 60,000 hours, Luminus Big Chip LEDs are ready for even the most demanding applications.

Environmental Benefits

Luminus LEDs help reduce power consumption and the amount of hazardous waste entering the environment. All Big Chip LED products manufactured by Luminus are RoHS compliant and free of hazardous materials, including lead and mercury.

Understanding Big Chip LED Test Specifications

Every Luminus LED is fully tested to ensure that it meets the high quality standards expected from Luminus' products.

Testing Temperature

Luminus surface mount LEDs are typically tested with a 20 msec input pulse and a junction temperature of 25°C. Expected flux values in real world operation can be extrapolated based on the information contained within this product data sheet.

Multiple Operating Points (7.0 A, 10.5 A)

The tables on the following pages provide typical optical and electrical characteristics. Since the LEDs can be operated over a wide range of drive conditions (currents from 1A to 10.5 A, and duty cycle from <1% to 100%), multiple drive conditions are listed.

SBT-70 White LEDs are production tested at 10.5 A. The values shown at other current conditions are for additional reference at other possible drive conditions.

SBT-70 White Binning Structure (T_j= 25°C)

SBT-70 white LEDs are tested for luminous flux and chromaticity at a drive current of 10.5 A (1.5 A/mm²) and placed into one of the following luminous flux (FF) and chromaticity (WW) bins:

Flux Bins

Color	Flux Bin (FF)	Minimum Flux (lm) at 10.5A	Maximum Flux (lm) at 10.5A
WCS Cool White Standard CRI (typ. 75)	NB	1,710	1,830
	PA	1,830	1,965
	PB	1,655	2,100
WDH Daylight White High CRI (typ. 90)	KA	1,040	1,120
	KB	1,120	1,200
	LA	1,200	1,290
WTH Tungsten White High CRI (typ. 92)	HB	840	900
	JA	900	970
	JB	970	1,040

*Note: Luminus maintains a +/- 6% tolerance on flux measurements.

Luminus maintains a +/- 2 tolerance on CRI measurements.



Chromaticity Bins

Chromaticity Bins: 1931 CIE Curve

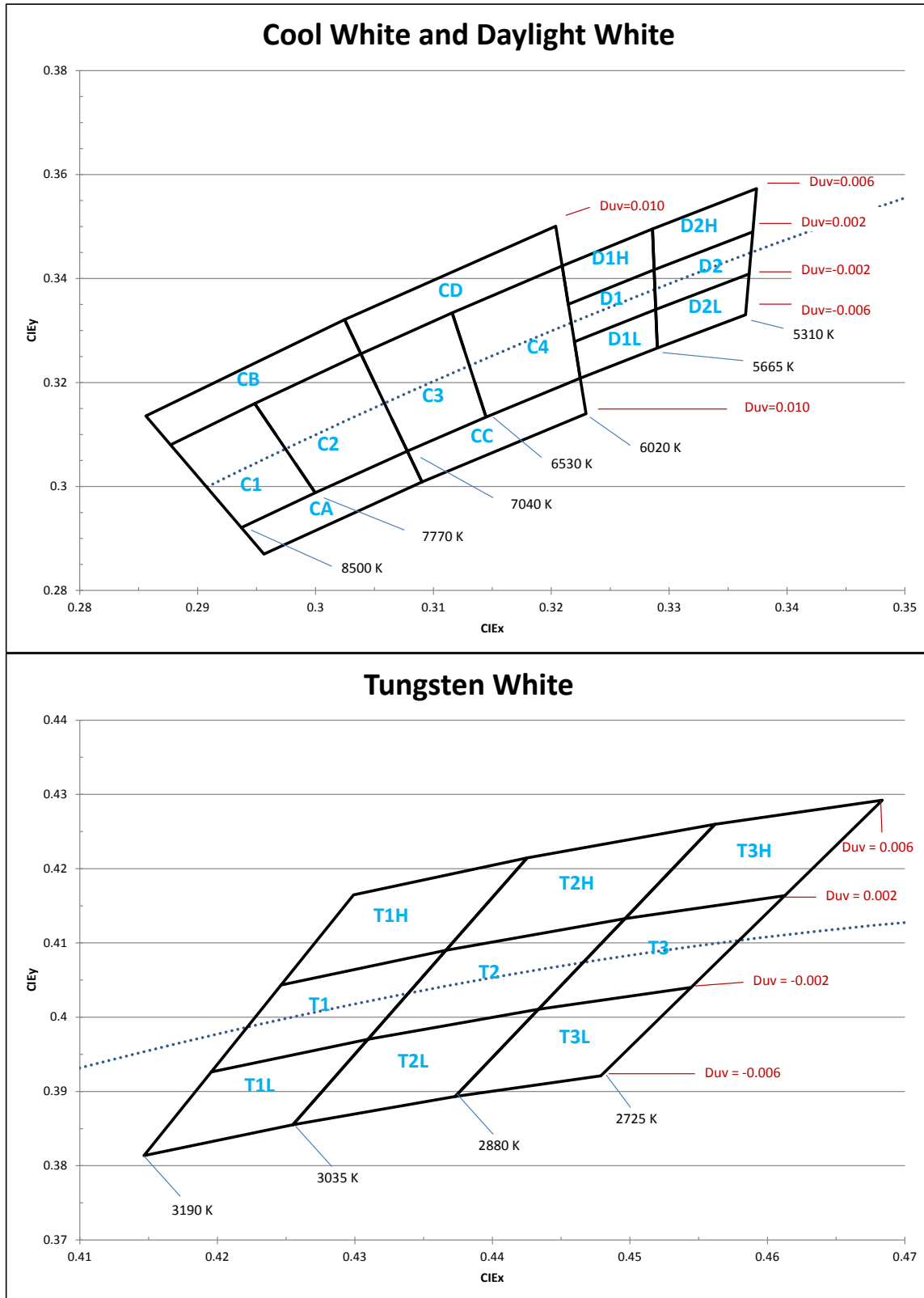

SBT-70 White Chromaticity Bins

The following tables describe the four chromaticity points that bound each chromaticity bin. Chromaticity bins are grouped together based on the color temperature.

Cool White Chromaticity Bins		
Bin Code(WW)	CIE _x	CIE _y
C1	0.293	0.292
	0.299	0.298
	0.294	0.315
	0.287	0.307
C2	0.299	0.298
	0.307	0.306
	0.303	0.325
	0.294	0.315
C3	0.307	0.306
	0.314	0.313
	0.311	0.333
	0.303	0.325
C4	0.314	0.313
	0.322	0.32
	0.32	0.342
	0.311	0.333

Cool White Chromaticity Bins		
Bin Code(WW)	CIE _x	CIE _y
CA	0.293	0.292
	0.295	0.287
	0.309	0.300
	0.307	0.306
CB	0.287	0.307
	0.285	0.313
	0.302	0.332
	0.303	0.325
CC	0.307	0.306
	0.309	0.300
	0.322	0.313
	0.322	0.320
CD	0.303	0.325
	0.302	0.332
	0.320	0.350
	0.320	0.342

SBT-70 White Chromaticity Bins

The following tables describe the four chromaticity points that bound each chromaticity bin. Chromaticity bins are grouped together based on the color temperature.

Daylight Chromaticity Bins		
Bin Code(WW)	CIE _x	CIE _y
D1	0.321	0.327
	0.321	0.335
	0.328	0.341
	0.328	0.334
D2	0.328	0.334
	0.328	0.341
	0.337	0.348
	0.336	0.340
D1H	0.321	0.335
	0.320	0.342
	0.328	0.349
	0.328	0.341
D2H	0.328	0.341
	0.328	0.349
	0.337	0.357
	0.337	0.348
D1L	0.321	0.327
	0.322	0.320
	0.328	0.326
	0.328	0.334
D2L	0.328	0.334
	0.328	0.326
	0.336	0.333
	0.336	0.340

Tungsten White Chromaticity Bins		
Bin Code(WW)	CIE _x	CIE _y
T1	0.419	0.392
	0.424	0.404
	0.436	0.409
	0.430	0.397
T2	0.430	0.397
	0.436	0.409
	0.449	0.413
	0.443	0.401
T3	0.443	0.401
	0.449	0.413
	0.461	0.416
	0.454	0.404
T1H	0.424	0.404
	0.429	0.416
	0.442	0.421
	0.436	0.409
T2H	0.436	0.409
	0.442	0.421
	0.456	0.425
	0.449	0.413
T3H	0.449	0.413
	0.456	0.425
	0.468	0.429
	0.461	0.416
T1L	0.419	0.392
	0.414	0.381
	0.425	0.385
	0.430	0.397
T2L	0.430	0.397
	0.425	0.385
	0.437	0.389
	0.443	0.401
T3L	0.443	0.401
	0.437	0.389
	0.447	0.392
	0.454	0.404

SBT-70 R, G, B Binning Structure ($T_j = 25^\circ\text{C}$)

SBT-70 monochromatic LEDs are tested for luminous flux and dominant wavelength at a 10.5 A (1.5 A/mm²) drive current and placed into one of the following flux and wavelength bins. The binning structure is universally applied across each monochromatic color.

Flux Bins (measured at 10.5A drive current)

Color	Luminous Flux Bin (FF)	Minimum Flux	Maximum Flux
Red	BK	600	770
	BM	770	970
Green	CJ	1200	1500
	CK	1500	2000
Blue	DJ	250	350
	DK	350	450

*Note: Luminus maintains a +/- 6% tolerance on flux measurements.

Wavelength Bins

Color	Wavelength Bin (FF)	Minimum Wavelength @ 10.5A	Maximum Wavelength @ 10.5A
Red	R3	615	619
	R4	619	623
	R5	623	627
Green	G4	520	525
	G5	525	530
	G6	530	535
	G7	535	540
Blue	B4	450	455
	B5	455	460
	B6	460	465
	B7	465	470

Product Shipping & Labeling Information

All SBT-70 products are packaged and labeled with their respective bin as outlined in the tables and charts on pages 3 - 7. When shipped, each package will only contain one bin. The part number designation is as follows:

SBT-70 White

SBT — 70 — WNX — F75 — FF — WW

Product Family	Chip Area	Color	Package Configuration	Flux Bin	Chromaticity Bin
Surface Mount (window)	7.0 mm ²	Color & CRI See Note 1 below	Internal Code	See page 3 for bins	See page 4 for bins

Note 1: WNX nomenclature corresponds to the following:

W = White

N = color, where: C corresponds to Cool White, D corresponds to Daylight, and T corresponds to Tungsten White;

R corresponds to red, G corresponds to green and B corresponds to blue.

X = color rendering index, where:

S (Standard) corresponds to a typical CRI of 75

H (high) corresponds to a typical CRI of 92

Example 1:

The part label SBT-70-WDH-F75-LA-D2 refers to a Daylight high CRI white, SBT-70 emitter, with a flux range from 1,200 to 1,290 lumens and a chromaticity value within the box defined by the four points (0.328, 0.334), (0.328, 0.341), (0.337, 0.348), (0.336, 0.340).

SBT-70-R, G, B

SBT — 70 — N — F75 — FF — WW

Product Family	Chip Area	Color	Package Configuration	Flux Bin	Wavelength Bin
Surface Mount (window)	7.0 mm ²	R: Red G: Green B: Blue	Internal Code	See page 7 for bins	See page 7 for bins

Example:

The part number SBT-70-R-F75-BK-R4 refers to a red, SBT-70 surface mount, with a flux range of 600 - 770 lumens and a wavelength range of 619 nm to 623 nm.

Note: Some flux and wavelength bins may have limited availability. Application specific bin kits, consisting of multiple bins, may be available. For ordering information, please refer to page 20 and reference the PDS-002041: SBT-70 Binning & Labeling document.

SBT-70 White Electrical Characteristics¹

Optical and Electrical Characteristics (T_j = 25°C)

Drive Condition ²		7.0 A	10.5 A	
Parameter	Symbol	Typical Values at Indicated Current ³	Values at Test Currents	Unit
Current Density	j	1.0	1.5	A/mm ²
Forward Voltage	V _{F,min}		3.5	V
	V _{F,typ}	3.3	3.7	V
	V _{F,max}		4.5	V

Common Characteristics

Parameter	Symbol	Typical Values	Unit
Emitting Area		7.0	mm ²
Color Rendering Index (Typical)	Cool White	CRI	75
	Daylight White	CRI	92
	Tungsten White	CRI	92
Forward Voltage Temperature Coefficient ⁴		-2.45	mV/°C

Absolute Maximum Ratings

Parameter	Symbol	Values	Unit
Maximum Current ⁵		10.5	A
Maximum Junction Temperature ⁶	T _{J,max}	150	°C
Storage Temperature Range		-40/+100	°C

Note 1: All ratings are based on operation at room temperature.

Note 2: Listed drive conditions are typical for common applications. SBT-70 white devices can be driven at currents ranging from 1A to 10.5A and at duty cycles ranging from 1% to 100%. Drive current and duty cycle should be adjusted as necessary to maintain the junction temperature desired to meet application lifetime requirements.

Note 3: Unless otherwise noted, values listed are typical.

Note 4: CCT value based off of CIE measurement. CIE measurement uncertainty for white devices is estimated to be +/- 0.01.

Note 5: Forward voltage temperature coefficient at current density of 1.5 A/mm². Contact Luminus for value at other drive conditions.

Note 6: SBT-70 White LEDs are designed for operation to an absolute maximum forward drive current density of 1.5 A/mm². Product lifetime data is specified at recommended forward drive currents. Sustained operation at absolute maximum currents will result in a reduction of device lifetime compared to recommended forward drive currents. Actual device lifetimes will also depend on junction temperature. Refer to the lifetime derating curves for further information. In pulsed operation, rise time from 10-90% of forward current should be larger than 0.5 microseconds.

Note 7: Lifetime dependent on LED junction temperature. Input power and thermal system must be properly managed to ensure lifetime. See charts on pg 10 for further information.

Note 8: Special design considerations must be observed for operation under 1 A. Please contact Luminus for further information.

Note 9: Caution must be taken not to stare at the light emitted from these LEDs. Under special circumstances, the high intensity could damage the eye.

SBT-70 White Optical & Electrical Characteristics

Relative Output Flux vs. Forward Current

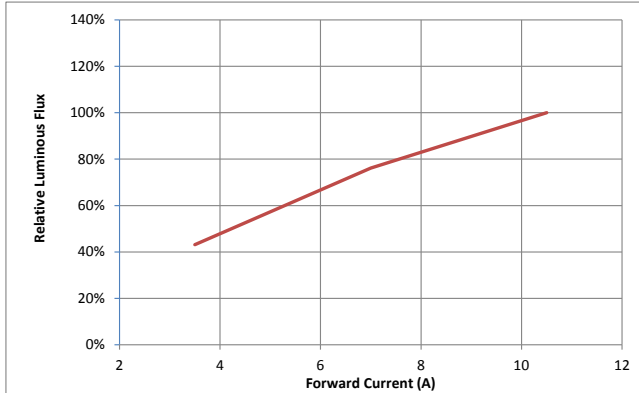

Forward Current vs. Forward Voltage

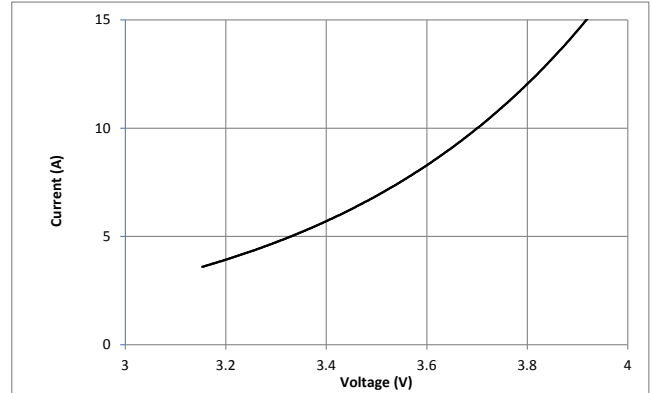

Relative Output Flux vs. Junction Temp

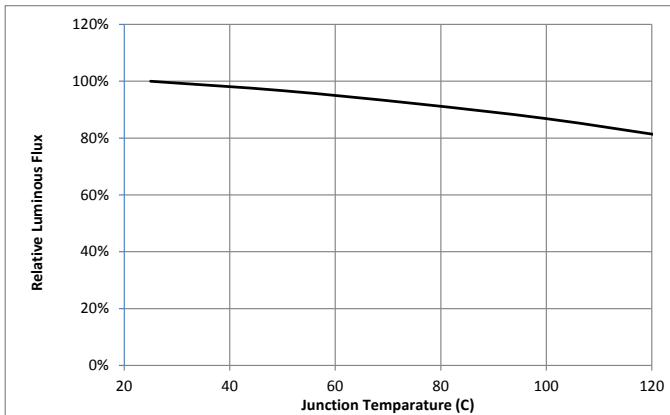

Change in Voltage vs. Junction Temp

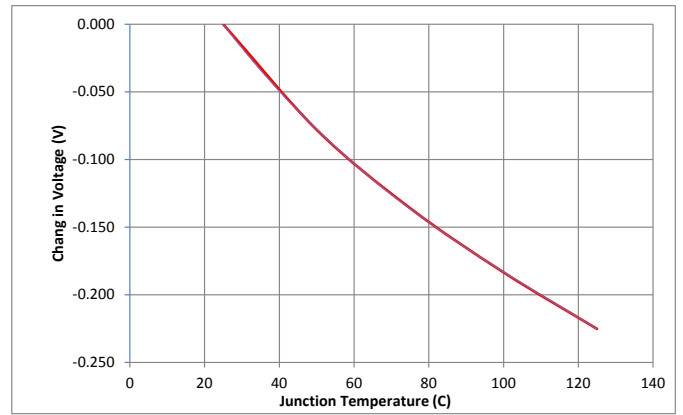

Typical Spectrum¹

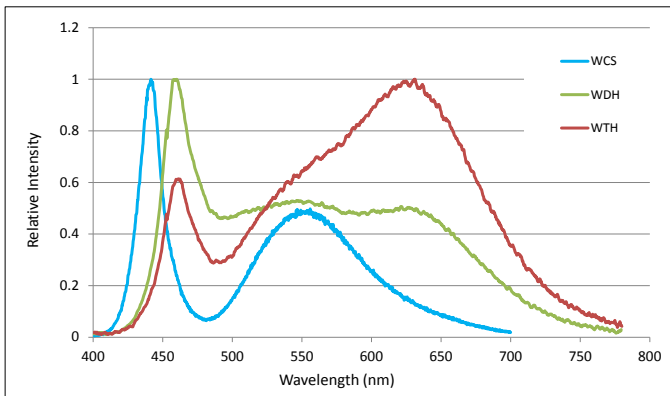

Current Derating Curve

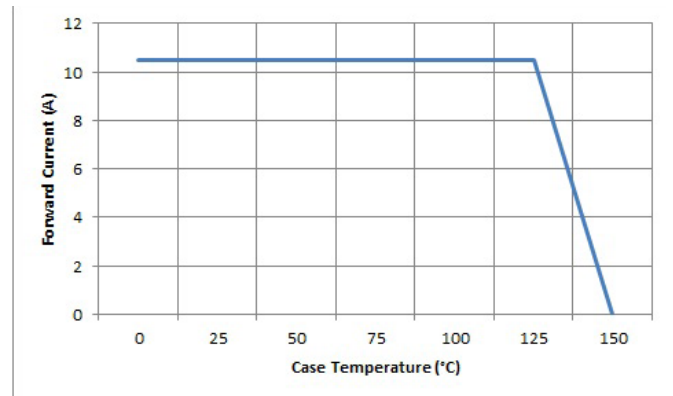

Note 1: Typical spectrum at current density of 1.5 A/mm² in continuous operation.

SBT-70 White Optical & Electrical Characteristics

Median Lifetime²

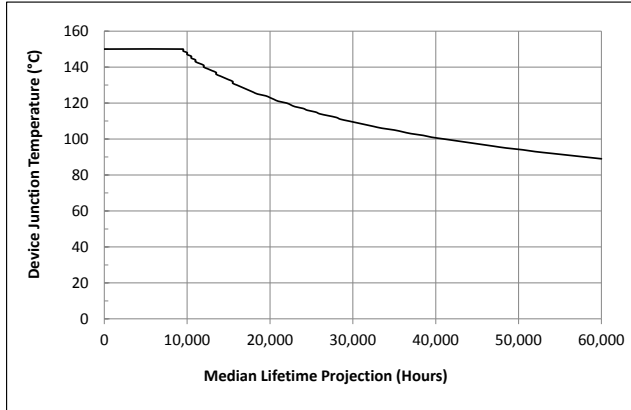

Lumen Maintenance vs. Time³

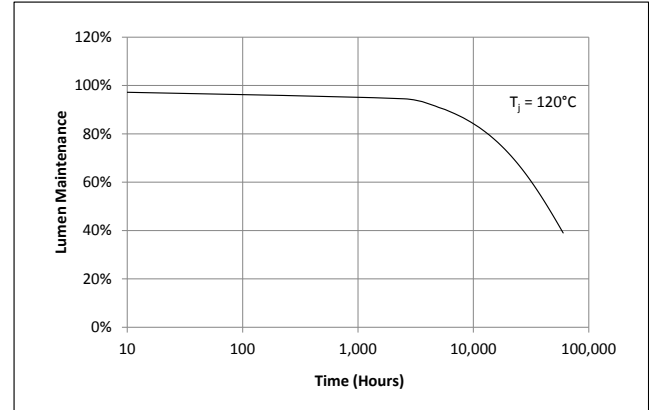

Chromaticity Change vs. Junction Temp (WTH)

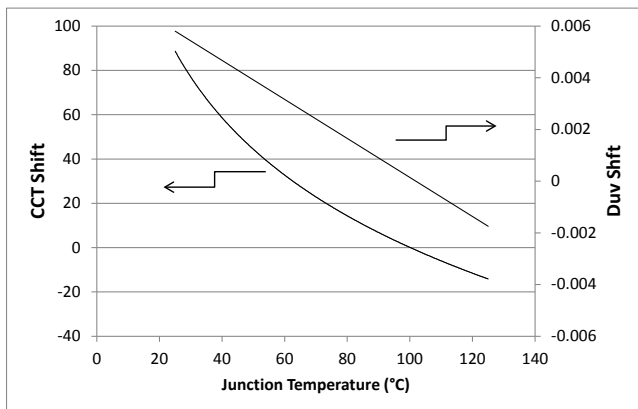

Chromaticity Change vs. Forward Current (WTH)

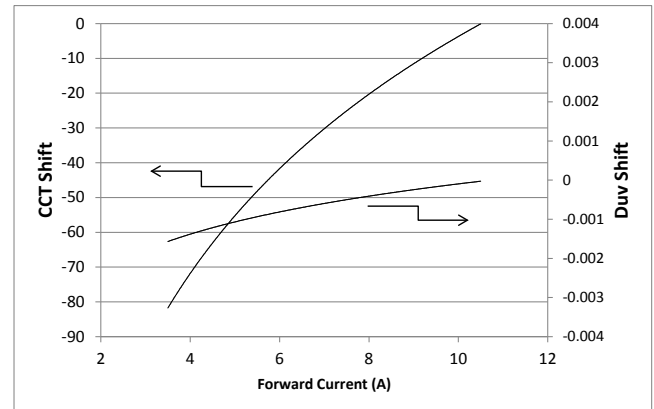

Typical Polar Radiation Pattern

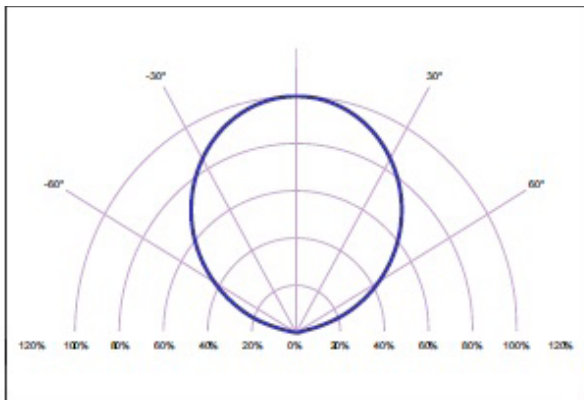

Typical Angular Radiation Pattern

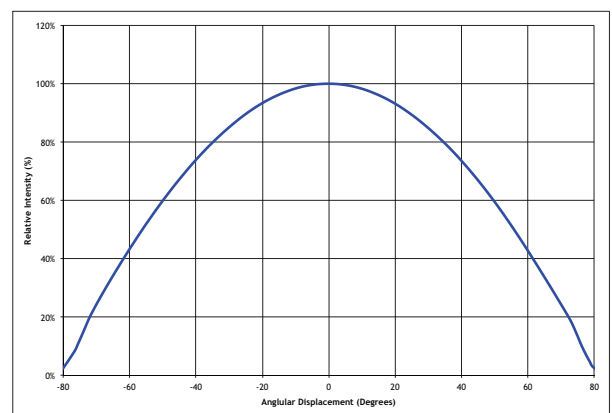

Note 2: Mean expected lifetime in dependence of junction temperature at 1.5 A/mm² in continuous operation. Lifetime defined as time to 70% of initial intensity. Based on lifetime test data. Data can be used to model failure rate over typical product lifetime (contact Luminus for lifetime reliability test data for 1A/mm² condition).

Note 3: Lumen maintenance in dependence of time at 1.5 A/mm² in continuous operation with junction temperatures of 130 °C.

SBT-70-R, G, B Optical & Electrical Characteristics

Red			
Drive Condition ²		10.5A	
Parameter	Symbol	Values ³	Unit
Current Density	j	1.5	A/mm ²
Forward Voltage	V _{F min}	2.5	V
	V _F	2.7	V
	V _{F max}	3.0	V
Luminous Flux ⁴	Φ _{V typ}	860	lm
Dominant Wavelength ⁵	λ _d	620	nm
FWHM	Δλ _{1/2}	18	nm
Chromaticity Coordinates ^{6,7}	x	0.695	-
	y	0.305	-

Relative Output Flux vs. Forward Current¹

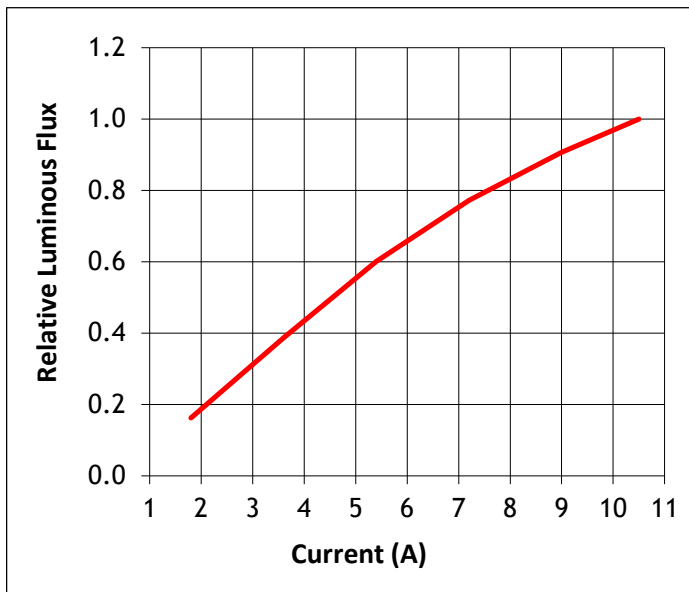

Forward Current vs. Forward Voltage

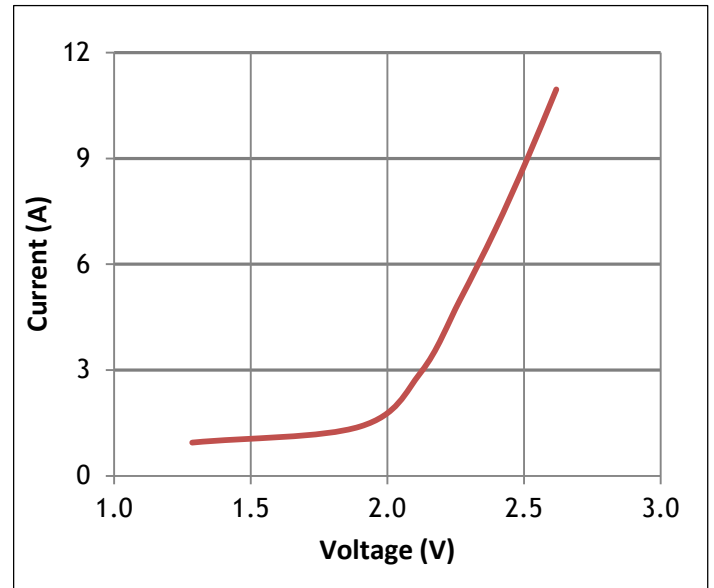

Note: For notes see page 15.

SBT-70 R, G, B, Optical & Electrical Characteristics

Green			
Drive Condition ²		10.5 A	
Parameter	Symbol	Values ³	Unit
Current Density	j	1.5	A/mm ²
Forward Voltage	V _{F min}	4.5	V
	V _F	4.9	V
	V _{F max}	5.3	V
Luminous Flux ⁴	Φ _{V typ}	1890	lm
Dominant Wavelength ⁵	λ _d	530	nm
FWHM	Δλ _{1/2}	32	nm
Chromaticity Coordinates ^{6,7}	x	0.205	-
	y	0.740	-

Relative Output Flux vs. Forward Current¹

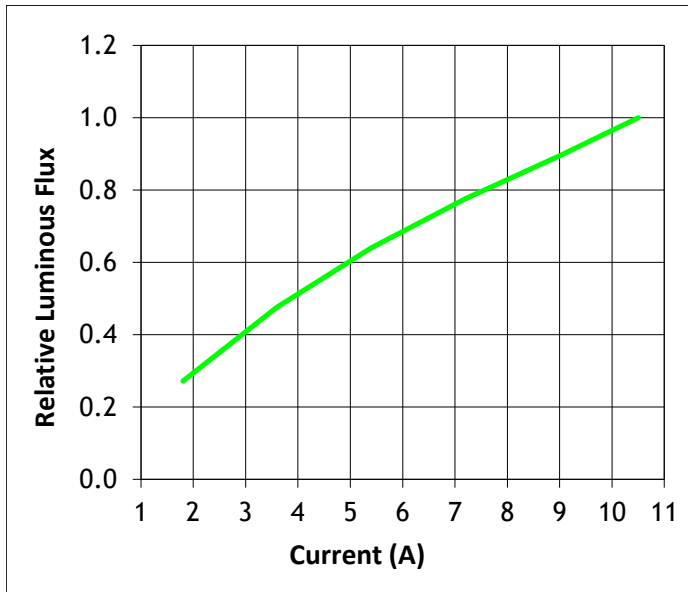

Forward Current vs. Forward Voltage

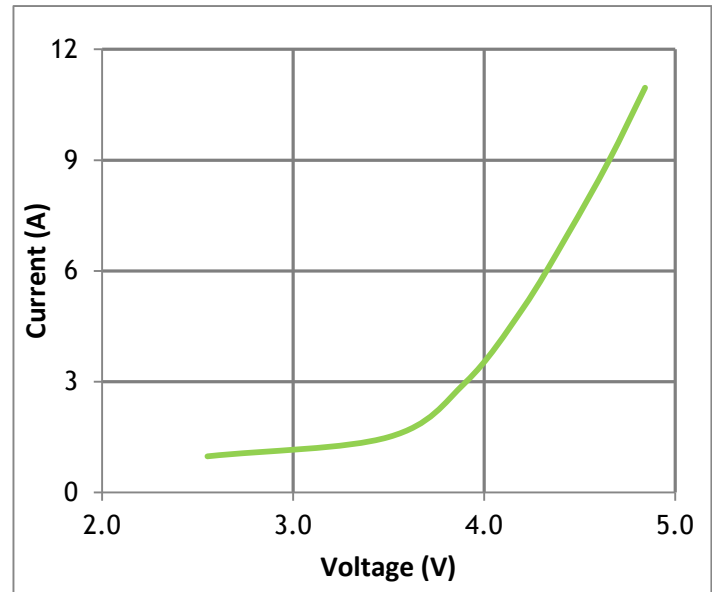

Note: For notes see page 15.

SBT-70 R, G, B, Optical & Electrical Characteristics

Blue			
Drive Condition ²		10.5 A	
Parameter	Symbol	Values ³	Unit
Current Density	j	1.5	A/mm ²
Forward Voltage	V _{F min}	3.2	V
	V _F	3.8	V
	V _{F max}	4.2	V
Luminous Flux ⁴	Φ _{V typ}	410	lm
Dominant Wavelength ⁵	λ _d	461	nm
FWHM	Δλ _{1/2}	19	nm
Chromaticity Coordinates ^{6,7}	x	0.142	0.142
	y	0.036	0.038

Relative Output Flux vs. Forward Current¹

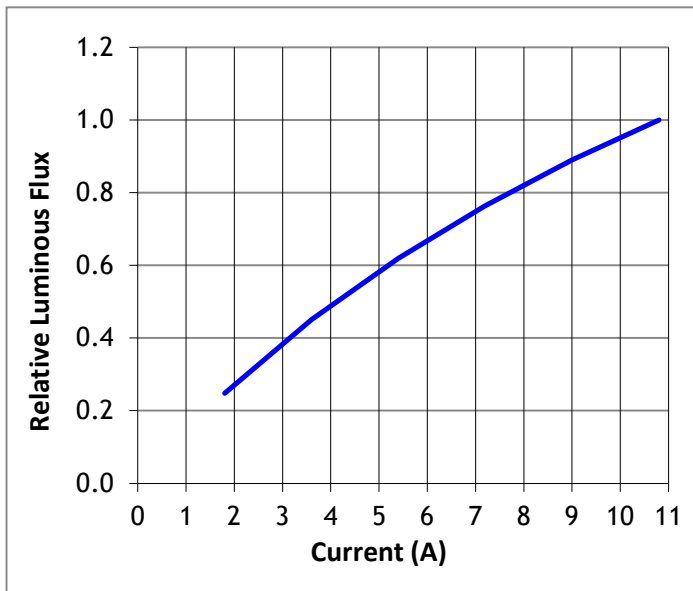

Forward Current vs. Forward Voltage

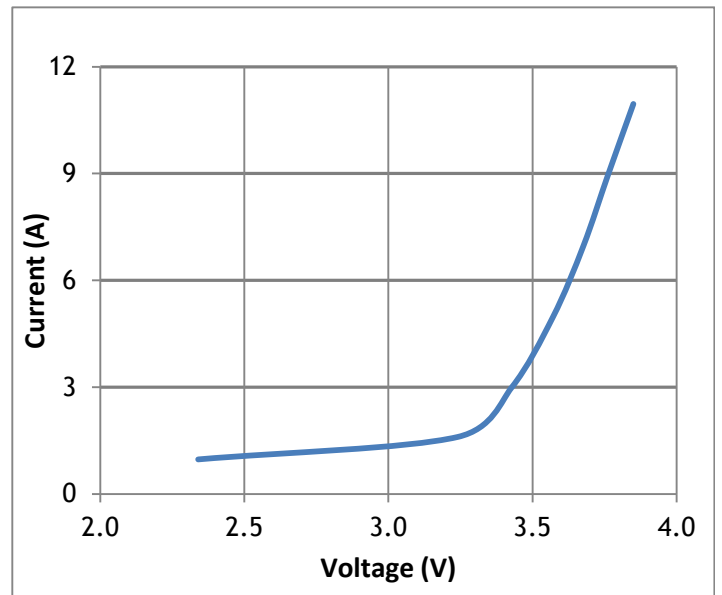

Note: For notes see page 15.

SBT-70, R, G, B, Optical & Electrical Characteristics Notes

- Note 1: All ratings are based on a junction test temperature $T_j = 25^\circ\text{C}$. See Thermal Resistance section for T_j definition.
- Note 2: Listed drive conditions are typical for common applications. Big Chip LED SBT-70 RGB devices can be driven at currents ranging from <1 A to 10.5 A and at duty cycles ranging from 1% to 100%. Drive current and duty cycle should be adjusted as necessary to maintain the junction temperature desired to meet application lifetime requirements.
- Note 3: Unless otherwise noted, values listed are typical. Devices are production tested and specified at 10.5A. Other values are for reference only.
- Note 4: Total flux from emitting area at listed dominant wavelength. Reported performance is included to show trends for a selected power level. For specific minimum and maximum values, use bin tables. For product roadmap and future performance of devices, contact Luminus.
- Note 5: Minimum and Maximum Dominant Wavelengths are based on typical values ± 5 nm for Red, ± 8 nm for Green and ± 6 nm for Blue.
- Note 6: In CIE 1931 chromaticity diagram coordinates, normalized to $X+Y+Z=1$.
- Note 7: For reference only.

SBT-70-R, G, B

Common Characteristics

	Symbol	Red	Green	Blue	Unit
Emitting Area		7.0	7.0	7.0	mm ²
Emitting Area (Diameter)		3	3	3	mm
Dynamic Resistance	Ω_{dyn}	0.03	0.04	0.02	Ω
Thermal Coefficient of Photometric Flux		-0.96	-0.18	-0.007	%/ $^\circ\text{C}$
Thermal Coefficient of Radiometric Flux		-0.52	-0.20	-0.17	%/ $^\circ\text{C}$
Thermal Coefficient of Junction Voltage		-1.3	-4.6	-3.5	mV/ $^\circ\text{C}$

Absolute Maximum Ratings

	Symbol	Red	Green	Blue	Unit
Maximum Current ⁸		10.5	10.5	10.5	A
Maximum Junction Temperature ⁹	$T_{j\text{max}}$	100	150	150	$^\circ\text{C}$
Storage Temperature Range		-40/+100	-40/+100	-40/+100	$^\circ\text{C}$

- Note 8: Luminus Big Chip LEDs are designed for operation to an absolute maximum current as specified above. Product lifetime data is specified at recommended forward drive currents. Sustained operation at or beyond absolute maximum currents will result in a reduction of device life time compared to recommended forward drive currents. Actual device lifetimes will also depend on junction temperature. Refer to the lifetime derating curves for further information. In pulsed operation, rise time from 10-90% of forward current should be larger than 0.5 microseconds.
- Note 9: Lifetime dependent on LED junction temperature. Input power and thermal system must be properly managed to ensure lifetime. See charts on pg 16 for further information.

SBT-70-R, G, B, Output vs. Temp., Lifetime and Spectrum

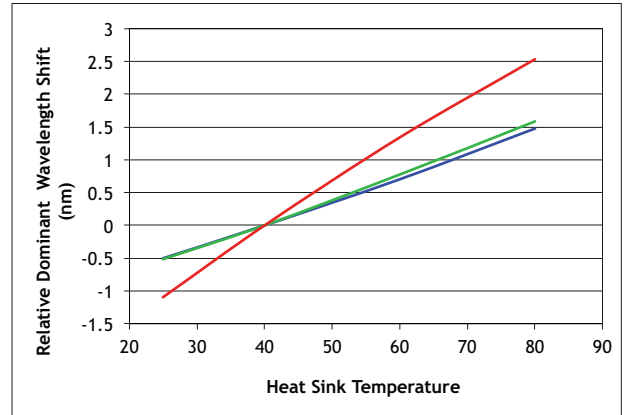
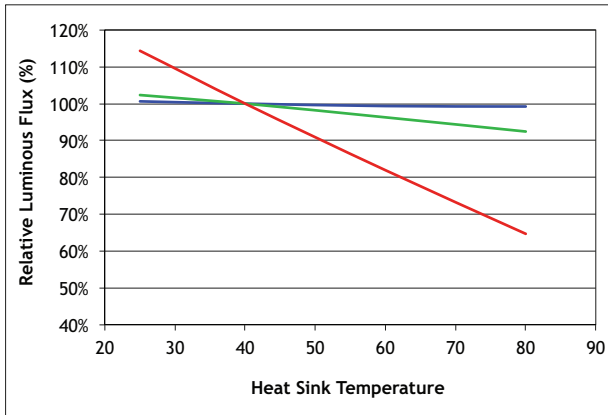

Median Lifetime Estimate vs. Tj¹

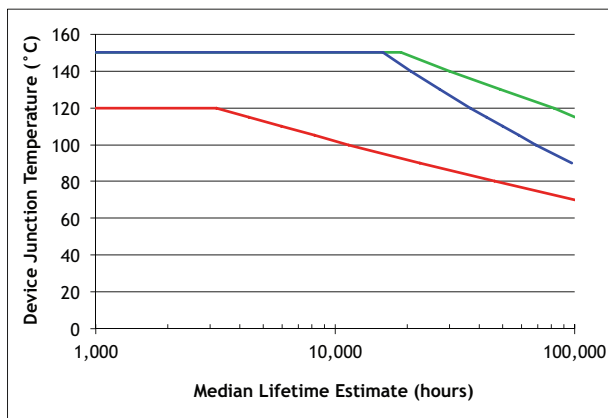

Lumen Maintenance²

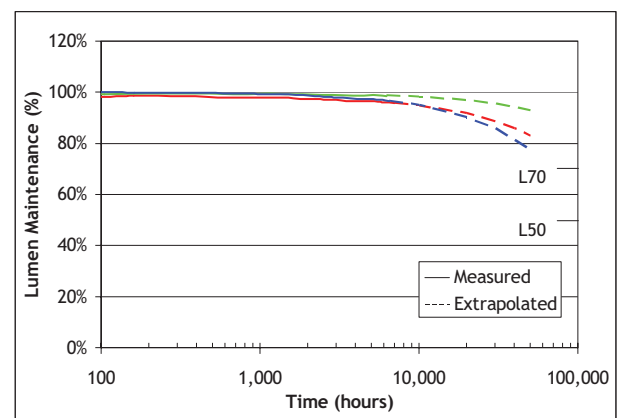

Typical Spectrum³

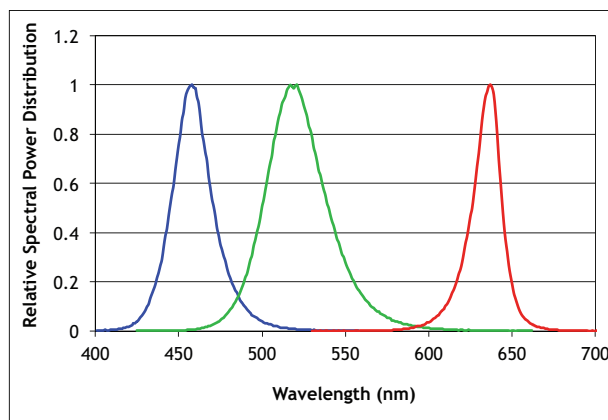

Note 1. Median lifetime estimate as a function of junction temperature at 1.5A/mm² in continuous operation. Lifetime defined as time to 70% of initial intensity. Based on preliminary lifetime test data. Data can be used to model failure rate over typical product lifetime.

Note 2. Lumen maintenance vs. time at 1.5A/mm² in continuous operation, junction temperature equal to 25°C.

Note 3. Typical spectrum at current density of 1.5 A/mm² in continuous operation.

Thermal Resistance

Thermal Resistance Model

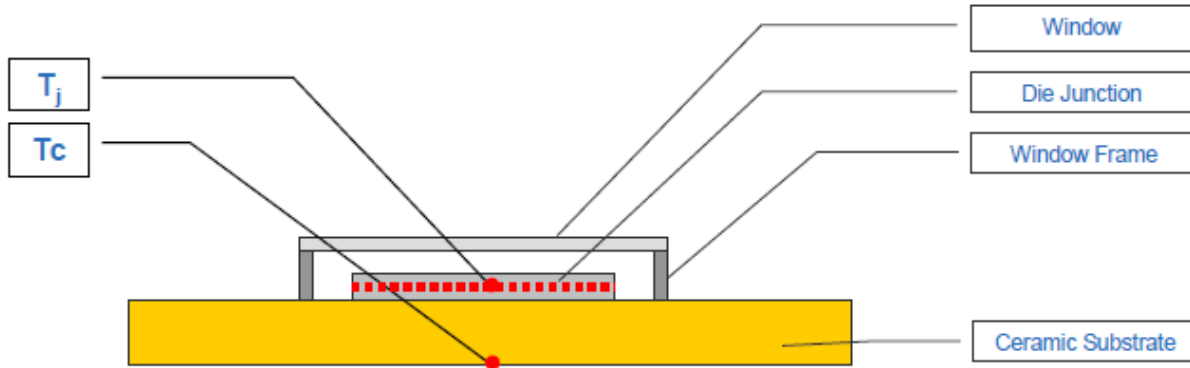

Typical Thermal Resistance

R_{j-c}^{-1}	0.7 °C/W
----------------	----------

Note 1: R_{j-c} is the thermal resistance from the junction T_j to the ceramic substrate, T_c

Note 1: Thermal resistance values are preliminary based on modeled results.

Mechanical Dimensions – SBT-70 Star Board

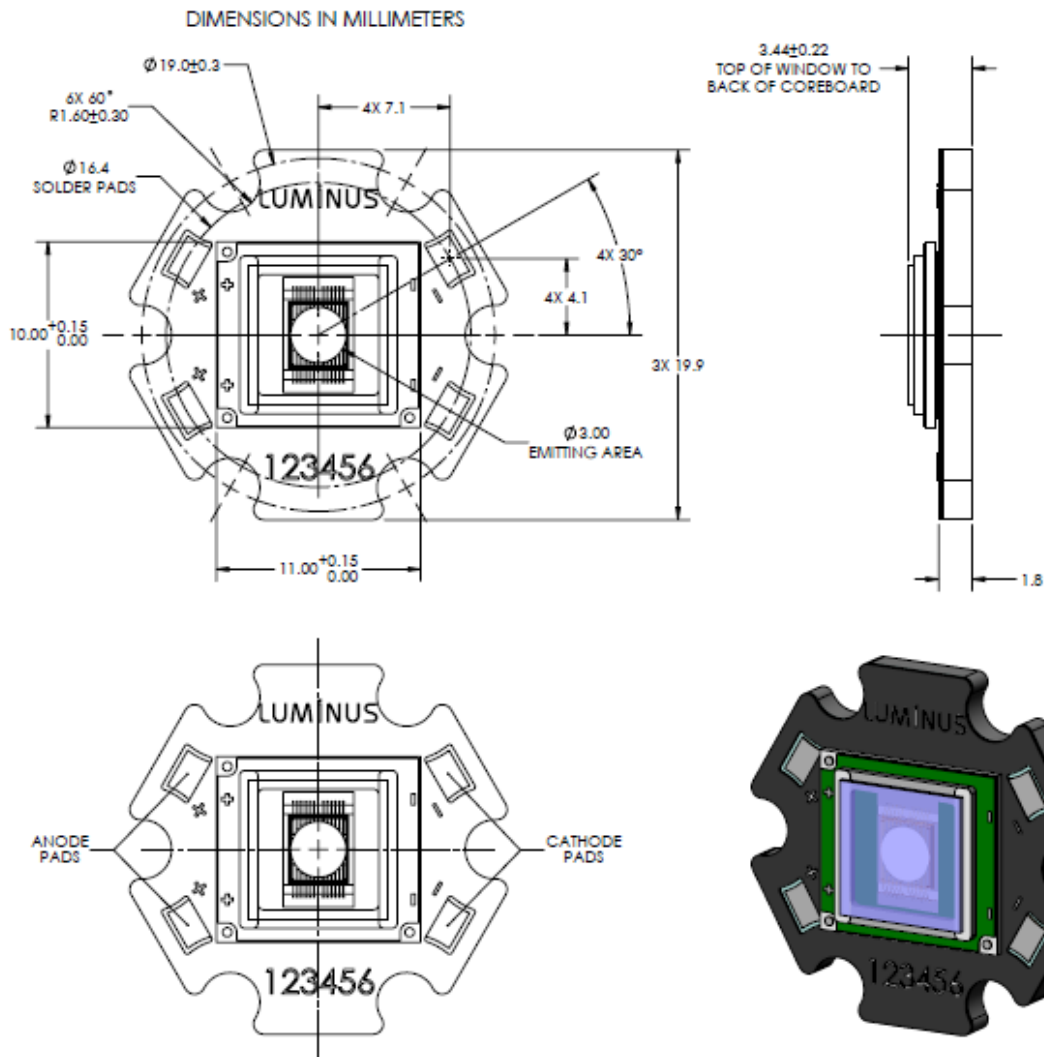

DWG-002153

Note 1: Tolerances per IPC-610, Class 2

Note 2: For detail drawing of SBT-90, please see DWG 002087

Note 3: Recommended mounting screw: M3 or #4

Note 4: All dimensions in millimeters

Note 5: All anode pads on board are interconnected. All cathode pads on board are interconnected

Ordering Information

Ordering Part Number ^{1,2,3,4}	Color	Description
SBT-70-WCS-F75-PA120	Cool White	White Big Chip LED™ SBT-70 consisting of a 7 mm ² LED on a ceramic substrate
SBT-70-WDH-F75-LA220	Daylight White	
SBT-70-WTH-F75-HB720	Tungsten White	
SBT-70-R-F75-HG100	Red	Red Big Chip LED™ SBT-70 consisting of a 7 mm ² LED on a ceramic substrate
SBT-70-G-F75-JF200	Green	Green Big Chip LED™ SBT-70 consisting of a 7 mm ² LED on a ceramic substrate
SBT-70-B-F75-KE300	Blue	Blue Big Chip LED™ SBT-70 consisting of a 7 mm ² LED on a ceramic substrate
SBR-70-WCS-R75-PA120	Cool White	White SBT-70 surface mount device mounted on an aluminum star board
SBR-70-WDH-R75-LA220	Daylight White	
SBR-70-WTH-R75-HB720	Tungsten White	
SBR-70-R-R75-HG100	Red	Red SBT-70 surface mount device mounted on an aluminum star board
SBR-70-G-R75-JF200	Green	Green SBT-70 surface mount device mounted on an aluminum star board
SBR-70-B-R75-KE300	Blue	Blue SBT-70 surface mount device mounted on an aluminum star board

Note 1: PA120 - denotes a bin kit comprising of all flux bins with a minimum flux of 1,830 lumens and chromaticity bins at cool white color point.

Note 2: LA220 - denotes a bin kit comprising of all flux bins with a minimum flux of 1,200 lumens and chromaticity bins at daylight white color point.

Note 3: HB720 - denotes a bin kit comprising of all flux bins with a minimum flux of 780 lumens and chromaticity bins at tungsten white color point.

Note 4: Standard packaging increment (SPI) is 25.

The products, their specifications and other information appearing in this document are subject to change by Luminus Devices without notice. Luminus Devices assumes no liability for errors that may appear in this document, and no liability otherwise arising from the application or use of the product or information contained herein. None of the information provided herein should be considered to be a representation of the fitness or suitability of the product for any particular application or as any other form of warranty. Luminus Devices' product warranties are limited to only such warranties as accompany a purchase contract or purchase order for such products. Nothing herein is to be construed as constituting an additional warranty. No information contained in this publication may be considered as a waiver by Luminus Devices of any intellectual property rights that Luminus Devices may have in such information. Big Chip LEDs™ is a registered trademark of Luminus Devices, Inc., all rights reserved.

This product is protected by U.S. Patents 6,831,302; 7,074,631; 7,083,993; 7,084,434; 7,098,589; 7,105,861; 7,138,666; 7,166,870; 7,166,871; 7,170,100; 7,196,354; 7,211,831; 7,262,550; 7,274,043; 7,301,271; 7,341,880; 7,344,903; 7,345,416; 7,348,603; 7,388,233; 7,391,059 Patents Pending in the U.S. and other countries.

X-ON Electronics

Largest Supplier of Electrical and Electronic Components

Click to view similar products for [LED Lighting Modules](#) category:

Click to view products by [Luminus Devices](#) manufacturer:

Other Similar products are found below :

[SFT-10-CG-R35-MPD](#) [LVS1-04C05-4070-00](#) [XHP35A-0R-12-0D0UB427E](#) [LPS1-01C24-4070-00](#) [LPS1-01C24-5070-00](#) [LPS1-04C24-4070-00](#) [LPS1-04C24-5070-00](#) [LSR1-04C32-4070-00](#) [XHP35A-0R-04-0D0UB427E](#) [LVS1-04C05-2790-00](#) [PT-121-BL11-EPF](#) [CBT-120-B-C11-KK301](#) [SMJC2V08W2P4-GA](#) [PT-54-RAX-L35-MPH](#) [LMH02B-3000-27G9-00001TW](#) [CDM-14-3018-90-36-DW02](#) [LMH02B-3000-40G9-00000TW](#) [LMH02B-3000-35G9-00000TW](#) [LMH02B-3000-30G9-00000TW](#) [LMH02B-2000-40G9-00001TW](#) [LMH02B-2000-35G9-00000TW](#) [LMH02B-2000-30G9-00000TW](#) [LMH02B-2000-27G9-00001TW](#) [LMH02B-1250-40G9-00001TW](#) [LMH02B-1250-35G9-00001TW](#) [LMH02B-1250-30G9-00001TW](#) [LMH02B-1250-27G9-00001TW](#) [LMH02B-1250-27G9-00000TW](#) [CBM-120-UV-C31-FA365-21](#) [SBR-90-R-R75-HN101](#) [SBR-90-R-R75-HN100](#) [SBR-70-G-R75-JK202](#) [SBR-70-B-R75-KG300](#) [PT-54-RAX-L35-MPN](#) [PT-54-RAX-L35-MPM](#) [PT-54-G-L31-MPJ](#) [PT-40-RAX-L55-MPL](#) [PT-40-RAX-L55-MPK](#) [PT-40-B-L51-EPJ](#) [PT-39-G-L51-CD100](#) [PT-39-G-L21-MPF](#) [PT-39-DR-L51-BD100](#) [PT-121-RAX-L15-MPK](#) [PT-121-B-L11-EPG](#) [PT-120-RAX-L15-MPK](#) [PT-120-B-L11-EPF](#) [CTM-9-6527-90-36-TW01](#) [CTM-9-4018-90-36-TW01](#) [CTM-22-6527-90-36-TW01](#) [CTM-22-4018-90-36-TW01](#)