

High Power White LEDs

SFT-70X-WxS

SFT-70X-WxE

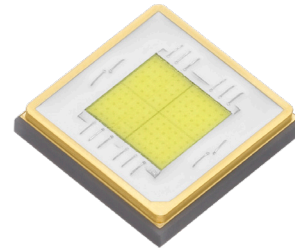

Table of Contents

Ordering Part Numbers.	2
Binning Information.	3
Chromaticity Binning Structure	4
Product Characteristics.	6
Soldering Profile	9
Precautions for Use.	10
Mechanical Dimensions	11
Tape and Reel	12
Packaging and Labeling	13
History of Changes	15

Features

The flat window of an SFT White LED results in a much smaller light emitting surface than with a dome-shaped cover, enabling much smaller optics and higher optical coupling efficiency. Along with the high lumen density of a monolithic emitter, SFT white series is a powerful light source for beam pattern critical lighting applications, in delivery of extremely high intensity, long beam distance and tight beam angles.

- 6V or 12V configurable, excellent color and brightness uniformity from a multi-junction single monolithic emitter.
- Cool white LEDs with a maximum output in excess of 3500 lm @ 7 A (6V), 85°C (6500K).
- High lumen density up to 554 lm/mm² (6500K)
- Maximum Drive Current: 7 A (6V), 3.5 A (12V)
- Luminous Efficacy: Typ. 156 lm/W @ 700 mA, 85°C (6500K)
- Color Temperature: 5000K, 5700K, 6500K
- Color Rendering Index: Typ. 73 (5000K, 5700K), Typ. 70 (6500K)
- Low thermal resistance: 0.6°C/W
- ANSI-compatible chromaticity bins
- Electrically isolated thermal path
- 8 kV HBM ESD rating per ANSI/ESDA/JEDEC JS-001
- RoHS and REACH compliant

Applications

- | | |
|-----------------------------------|--------------------------------|
| • Portable Lights | • LED Work Lights |
| • Automotive Auxiliary Lights | • Outdoor and Roadway Lighting |
| • Battery or Solar Powered Lights | • High Bay Industrial Lighting |

Ordering Part Numbers

CCT	CRI	Minimum Flux Bin ¹	Minimum Flux (lm)	Chromaticity Bin Kit Code ²	Ordering Part Numbers
5000K	Typ. 73 Min. 70	KA	1042	501	SFT-70X-W50E-H50-KA501
				502	SFT-70X-W50E-H50-KA502
		KB	1120	501	SFT-70X-W50E-H50-KB501
				502	SFT-70X-W50E-H50-KB502
5700K	Typ. 73 Min. 70	KA	1042	571	SFT-70X-W57E-H50-KA571
				572	SFT-70X-W57E-H50-KA572
6500K	Typ. 70 Min. 65	KB	1120	651	SFT-70X-W65S-H50-KB651
				652	SFT-70X-W65S-H50-KB652
		LA	1200	651	SFT-70X-W65S-H50-LA651
				652	SFT-70X-W65S-H50-LA652

Notes

1. The Ordering Part Number specifies the Minimum Flux Bin in shipment; higher flux bins may be shipped without advance notice. Please refer to 'Luminous Flux Binning' table for details of all flux bins.
2. Shipments always adhere to the color bins specified in each Chromaticity Bin Kit. See 'Chromaticity Bin Kit Codes' table for the color bins included in each Bin Kit.

Part Number Nomenclature

SFT — 70X — W<xy> — H50 — <ffcc>

Product Family	Light Emission Area	Light Color	Package Configuration	Bin Kit
S: Surface Mount F: Flat Window T: Single Emitter	70: 7.0 mm ² X: Multi-Junction	W: White <xx> Color Temperature 50: 5000K 65: 6500K <y> CRI Category Code S: CRI>65 E: CRI>70	H50: Package Code	<ff> Minimum Flux Bin, see 'Luminus Flux Binning' table for details <ccc> Chromaticity Bin Kit, see 'Chromaticity Bin Kit Codes' table for details

Luminous Flux Binning

Flux Bin Code	Binning @ 1500 mA(6V), T _j =85°C ¹		@ 700 mA, T _j =25°C ²	Correlated Minimum Flux (lm) @ T _j =85°C ²				
	Minimum Flux (lm)	Maximum Flux (lm)	Minimum Flux (lm)	700 mA	2000 mA	3000 mA	5250 mA	7000 mA
KA	1042	1120	595	531	1323	1834	2730	3251
KB	1120	1200	640	571	1422	1971	2934	3494
LA	1200	1290	685	612	1524	2112	3144	3744
LB	1290	1380	737	658	1638	2270	3380	4025

Notes

- LEDs are measured at 25°C ambient temperature with 1500 mA, 6V, 20ms single pulse. The measured values are correlated to 1500 mA, 6V, at 85°C junction temperature (T_j). Luminus maintains a ±6% tolerance on flux measurement.
- Flux values at other junction temperature (T_j) and/or forward current conditions are calculated and for reference only.

Chromaticity Binning Coordinates

CCT	Bin Code	CIE _x	CIE _y	Bin Code	CIE _x	CIE _y	Bin Code	CIE _x	CIE _y	Bin Code	CIE _x	CIE _y
5000K	DA	0.3371	0.3490	DB	0.3376	0.3616	DC	0.3463	0.3687	DD	0.3451	0.3554
		0.3451	0.3554		0.3463	0.3687		0.3551	0.3760		0.3533	0.3620
		0.3440	0.3427		0.3451	0.3554		0.3533	0.3620		0.3515	0.3487
		0.3366	0.3369		0.3371	0.3490		0.3451	0.3554		0.3440	0.3427
	DH	0.3366	0.3369	DE	0.3381	0.3762	DF	0.3480	0.3840	DG	0.3440	0.3428
		0.3440	0.3428		0.3480	0.3840		0.3571	0.3907		0.3515	0.3487
		0.3429	0.3307		0.3463	0.3687		0.3551	0.3760		0.3495	0.3339
		0.3361	0.3245		0.3376	0.3616		0.3463	0.3687		0.3429	0.3307
5700K	CA	0.3215	0.3350	CB	0.3207	0.3462	CC	0.3290	0.3538	CD	0.3290	0.3417
		0.3290	0.3417		0.3290	0.3538		0.3376	0.3616		0.3371	0.3490
		0.3290	0.3300		0.3290	0.3417		0.3371	0.3490		0.3366	0.3369
		0.3222	0.3243		0.3215	0.3350		0.3290	0.3417		0.3290	0.3300
	CH	0.3222	0.3243	CE	0.3196	0.3602	CF	0.3290	0.3690	CG	0.3290	0.3300
		0.3290	0.3300		0.3290	0.3690		0.3381	0.3762		0.3366	0.3369
		0.3290	0.3180		0.3290	0.3538		0.3376	0.3616		0.3361	0.3245
		0.3231	0.3120		0.3207	0.3462		0.3290	0.3538		0.3290	0.3180
6500K	BA	0.3048	0.3207	BB	0.3028	0.3304	BC	0.3115	0.3391	BD	0.3130	0.3290
		0.3130	0.3290		0.3115	0.3391		0.3205	0.3481		0.3213	0.3373
		0.3144	0.3186		0.3130	0.3290		0.3213	0.3373		0.3221	0.3261
		0.3068	0.3113		0.3048	0.3207		0.3130	0.3290		0.3144	0.3186
	BH	0.3068	0.3113	BE	0.3005	0.3415	BF	0.3099	0.3509	BG	0.3144	0.3186
		0.3144	0.3186		0.3099	0.3509		0.3196	0.3602		0.3221	0.3261
		0.3161	0.3059		0.3115	0.3391		0.3205	0.3481		0.3231	0.3120
		0.3093	0.2993		0.3028	0.3304		0.3115	0.3391		0.3161	0.3059

Chromaticity Binning Diagram

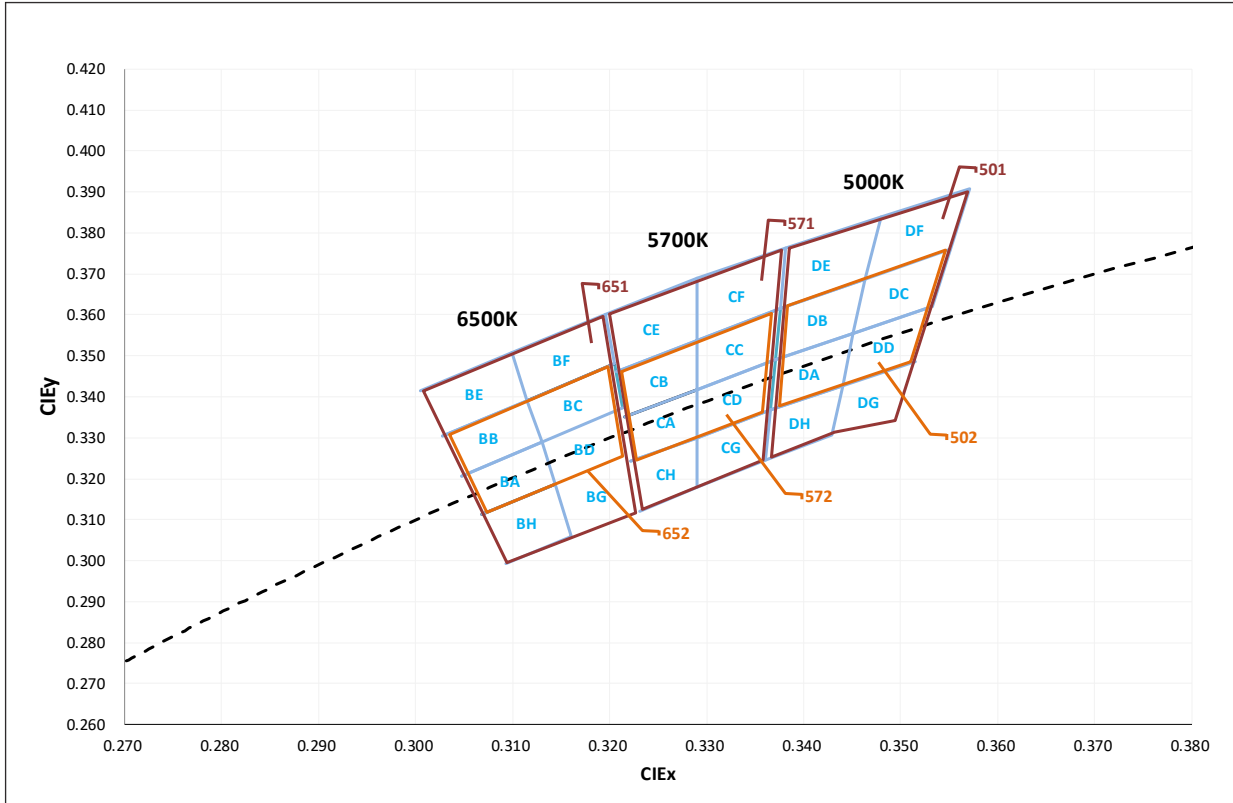

Chromaticity Bin Kit Codes

CCT	Bin Kit	Chromaticity Bins
5000K	501	DA, DB, DC, DD, DE, DF, DG, DH
	502	DA, DB, DC, DD
5700K	571	CA, CB, CC, CD, CE, CF, CG, CH
	572	CA, CB, CC, CD
6500K	651	BA, BB, BC, BD, BE, BF, BG, BH
	652	BA, BB, BC, BD

Note: Luminus maintains a tolerance of ± 0.005 on chromaticity (CIE_x, CIE_y), and ± 2 on Color Rendering Index (CRI) measurements.

Product Characteristics

Parameter	Symbol	Minimum	Typical	Maximum	Unit
Viewing Angle (FWHM)	$2\theta_{1/2}$		120		Degree
Color Rendering Index SFT-70X-WxS	CRI_{WxS}	65	70		
Color Rendering Index SFT-70X-WxE	CRI_{WxE}	70	73		
Thermal resistance (Electrical) Junction/Solder Point	$R_{thjs-EL}$		0.6		$^{\circ}C/W$
Junction Temperature	T_j			150	$^{\circ}C$
Forward Voltage (6V, @ $I_f=1500$ mA, $T_j=85^{\circ}C$)	$V_{f(6V)}$	5.25	5.75	6.25	V
Forward Voltage (12V, @ $I_f=750$ mA, $T_j=85^{\circ}C$)	$V_{f(12V)}$	10.5	11.5	12.5	V
DC Forward Current (6V)	$I_{f(6V)}$	0.2		7	A
DC Forward Current (12V)	$I_{f(12V)}$	0.1		3.5	A
Surge Current (t <10 ms, Duty Cycle < 10%)	$I_{s-max(6V)}$			8	A
Reverse Voltage ($I_r=10$ mA)	$V_{r(6V)}$			10	V
Power Dissipation	P_d			48	W
Operating Temperature	T_{opr}	-40		100	$^{\circ}C$
Storage Temperature	T_{stg}	-40		100	$^{\circ}C$
ESD withstand Voltage HBM Per ANSI/ESDA/JEDEC JS-001	V_{HBM}	8			kV
ESD withstand Voltage CDM Per ANSI/ESDA/JEDEC JS-002	V_{CDM}	1			kV

Optical & Electrical Characteristics

Relative Luminous Flux vs. Forward Current

$\Phi_v/\Phi_v(1.5\text{ A}, 6\text{ V}), T_j = 85^\circ\text{C}$

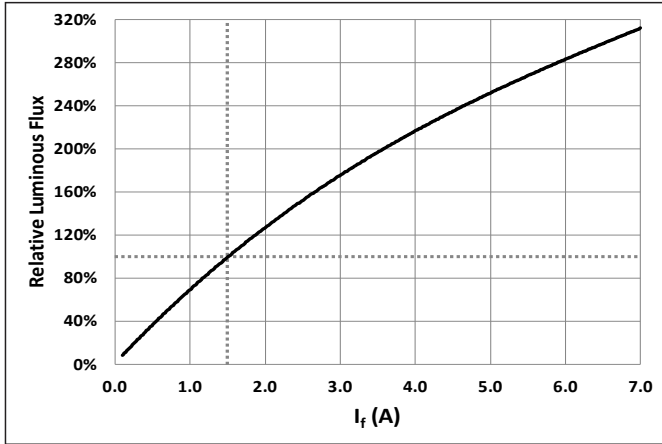

Relative Luminous Flux vs. Temperature (T_j)

$\Phi_v/\Phi_v(85^\circ\text{C}), I_f = 1.5\text{ A} (6\text{ V})$

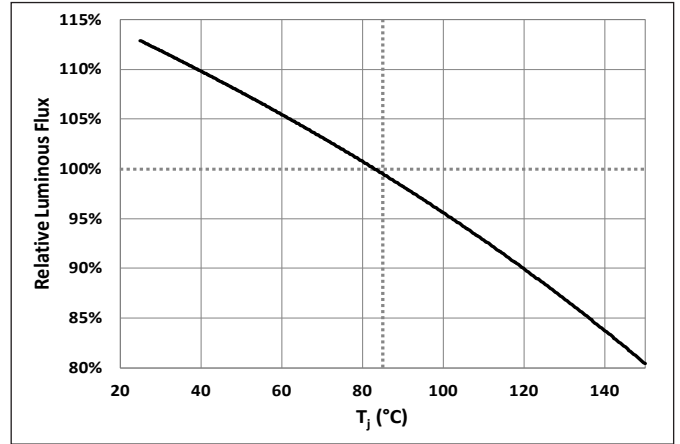

Forward Voltage vs. Forward Current

$V_f = f(I_{f-6V}), T_j = 85^\circ\text{C}$

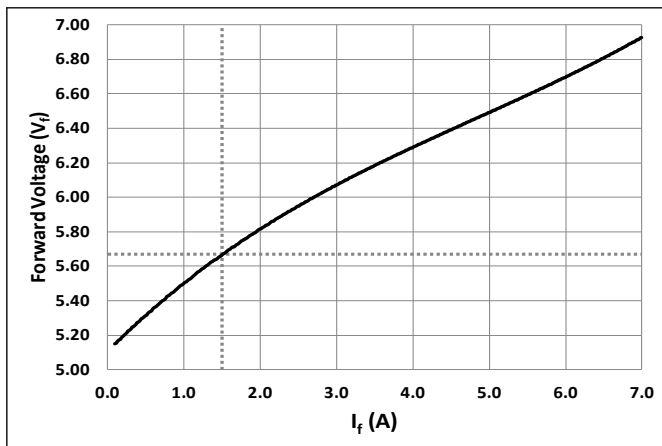

Relative Forward Voltage vs. Temperature (T_j)

$\Delta V_f = V_f(T_j) - V_f(85^\circ\text{C}), I_f = 1.5\text{ A} (6\text{ V})$

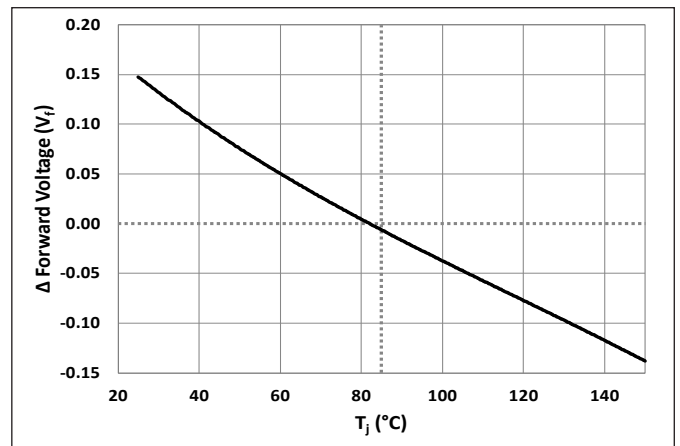

Relative Chromaticity vs. Forward Current

$\Delta \text{CIEx}, \Delta \text{CIEy} = \text{CIEx}, \text{CIEy}(I_f) - \text{CIEx}, \text{CIEy}(1.5\text{ A}, 6\text{ V}), T_j = 85^\circ\text{C}$

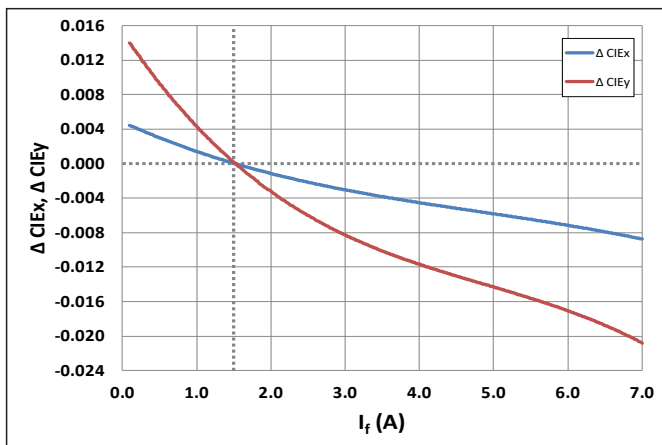

Relative Chromaticity vs. Temperature (T_j)

$\Delta \text{CIEx}, \Delta \text{CIEy} = \text{CIEx}, \text{CIEy}(T_j) - \text{CIEx}, \text{CIEy}(85^\circ\text{C}), I_f = 1.5\text{ A} (6\text{ V})$

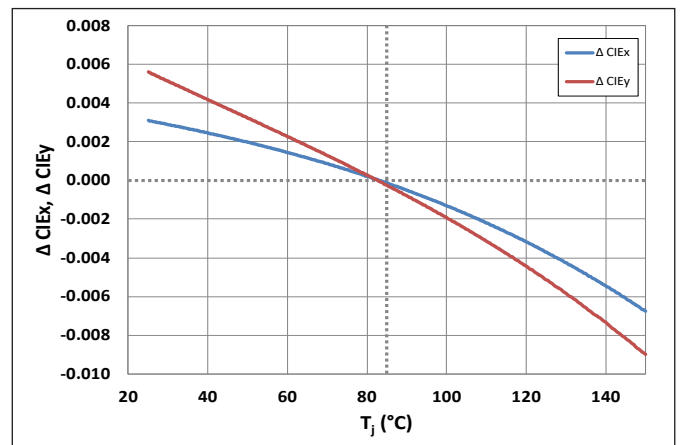

Relative Spectral Power Distribution

$I_f=1.5\text{ A (6V)}, T_j=85^\circ\text{C}$

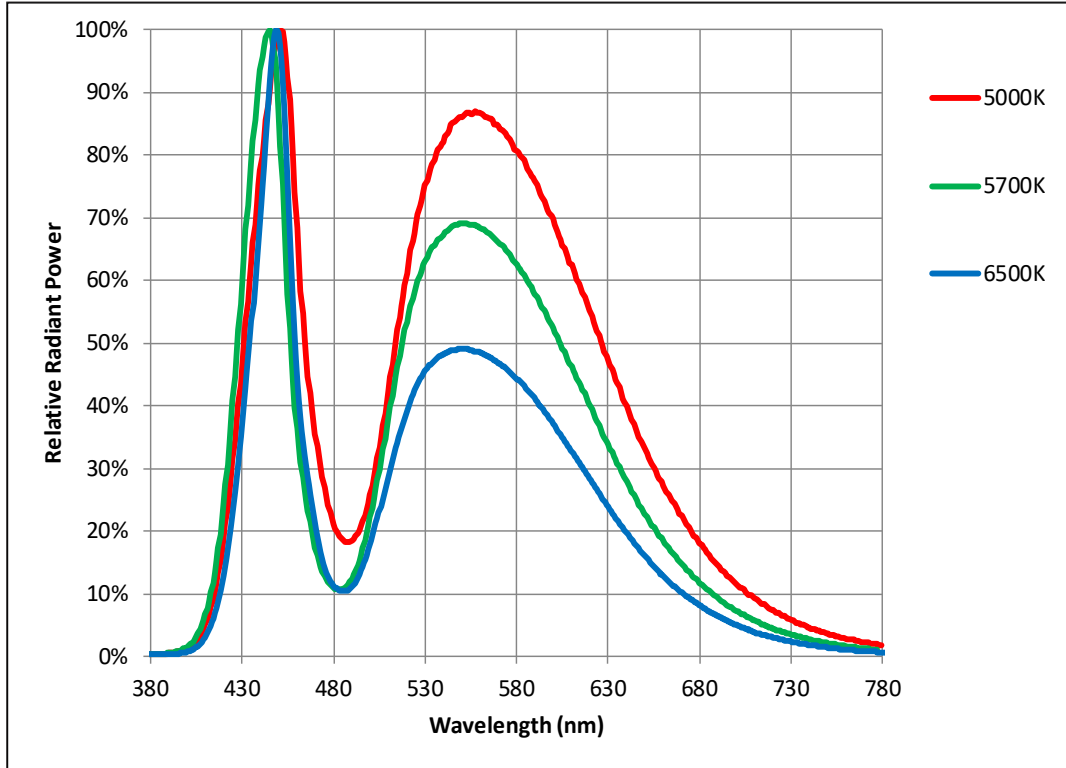

Typical Radiation Characteristics

$I_f=1.5\text{ A (6V)}, T_j=25^\circ\text{C}$

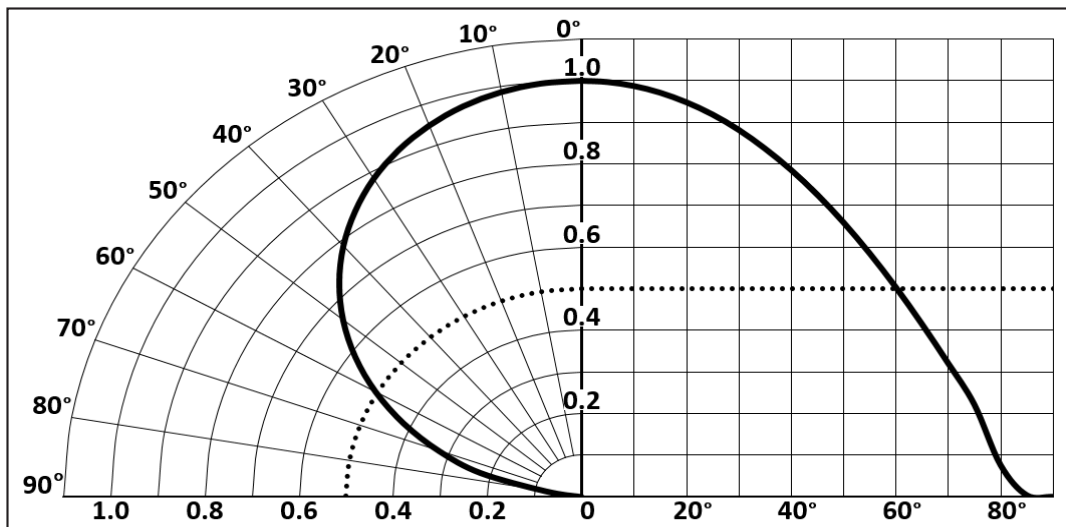

Soldering Profile

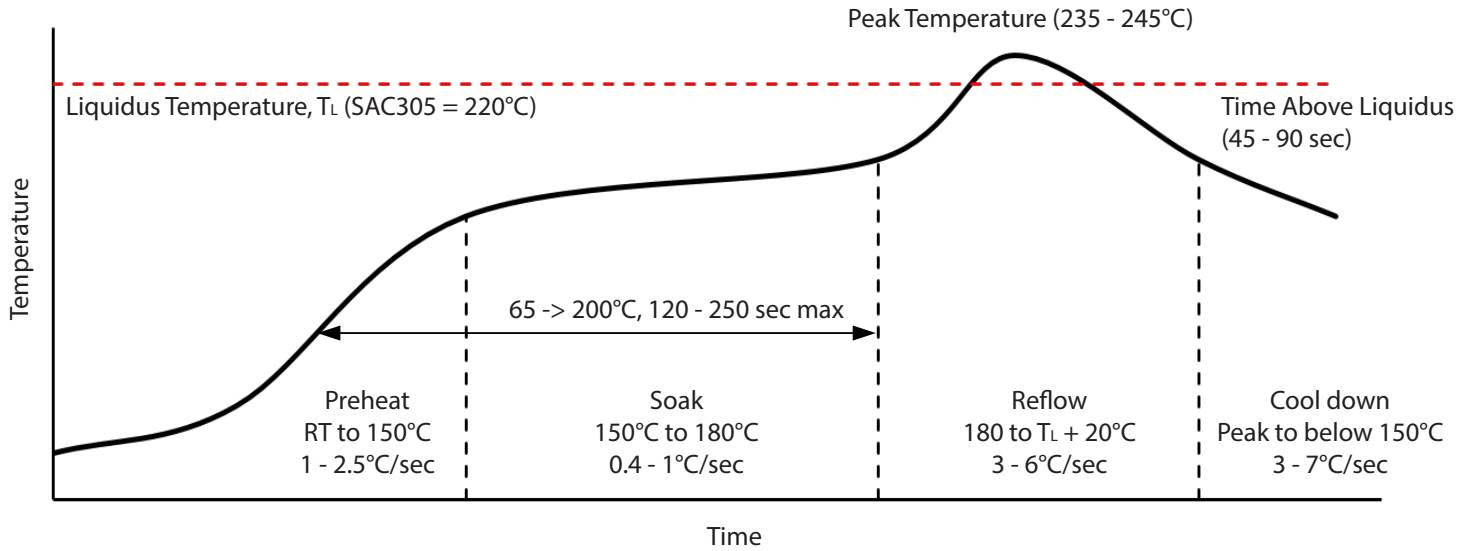

SMT Rework Guideline	Manual Hotplate Reflow	Hot Air Gun Reflow
Heating Time	< 60 sec	
Hotplate Temperature	< 245°C	< 150°C

Notes

- Product complies to Moisture Sensitivity Level 3 (MSL 3).
- The numbers in the table are specific to SAC305. Luminus recommends using an SAC305 solder paste with a no-clean flux for RoHS compliant products.
- During the pick and place process, ensure the pick-up tool does not touch any die components.
- Use of a multi-zone IR reflow oven with a nitrogen blanket is recommended.
- Time-temperature profile of the reflow process showing the four functional profile zones are defined in IPC-7801. Temperature is referenced to the center of the PCB.
- Luminus recommends to use the solder paste data sheet information as a starting point in time-temperature process development.
- These are general guidelines. Consult the solder paste manufacturer's datasheet for guidelines specific to the alloy and flux combination used in your application. For more information, please refer to: <https://luminusdevices.zendesk.com/hc/en-us/articles/360060306692-How-do-I-Reflow-Solder-Luminus-SMD-Components->
- For any technical questions about soldering process, please contact Luminus at techsupport@luminus.com.

Precautions for Use

Storage:

1. Before opening the package

The LEDs should be kept at a temperature lower than 40°C and relative humidity lower than 90%. The LEDs should be used within a year. When storing the LEDs, moisture proof package with absorbent material (silica gel) is recommended.

2. After opening the package

The LEDs should be kept at a temperature lower than 30°C and relative humidity lower than 60%. The LEDs should be soldered within 168 hours (7 days) after opening the moisture proof package.

If unused LEDs remain, they should be stored in moisture proof packages, such as sealed containers with moisture absorbent material (silica gel). It is also recommended to return the unused LEDs to the original moisture proof package and to seal it again.

If the moisture absorbent material (silica gel) vaporizes or passes the expiration date, baking treatment should be performed by using the following conditions : 60°C for 20 hours.

The LED's electrode and lead frame comprise a silver plated copper alloy. The silver surface may be affected by environments. Please avoid conditions which may cause the LEDs to corrode or discolor. The corrosion or discoloration might lower solderability or affect optical characteristics.

Please avoid rapid transition in ambient temperature, especially in high humidity environments where condensation can occur.

Static Electricity:

1. The products are sensitive to static electricity, and care should be taken when handling them.

2. Static electricity or surge voltage will damage the LEDs. It is recommended to wear anti-electrostatic gloves or wristband when handling the LEDs.

3. All devices, equipment and machinery must be properly grounded. It is recommended that measures be taken against surge voltage to the equipment that mounts the LEDs.

Package Configuration

Mechanical Dimensions

All dimensions are in millimeter ± 0.13 mm

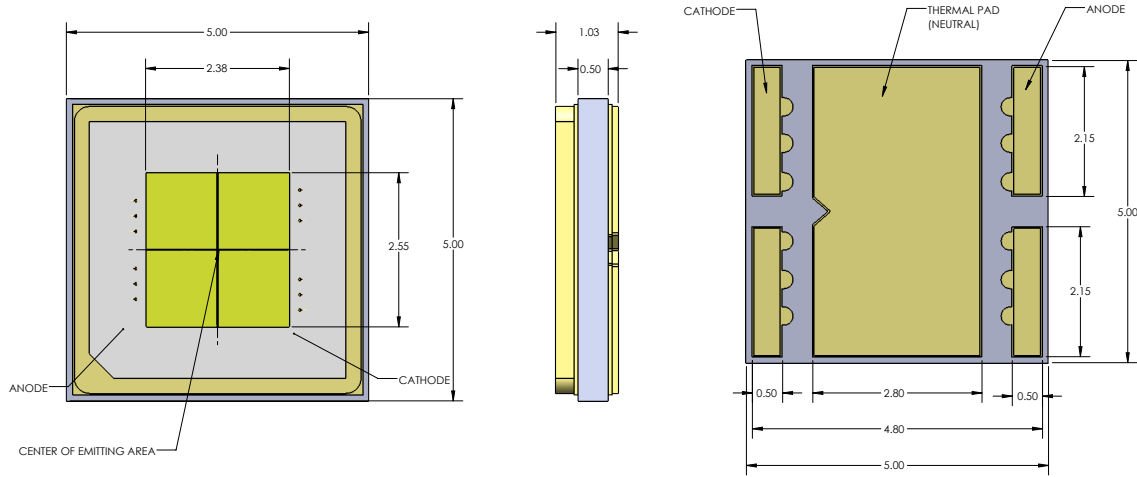

Recommended PCB Solder Pad and Stencil Pattern

All dimensions are in millimeter ± 0.13 mm

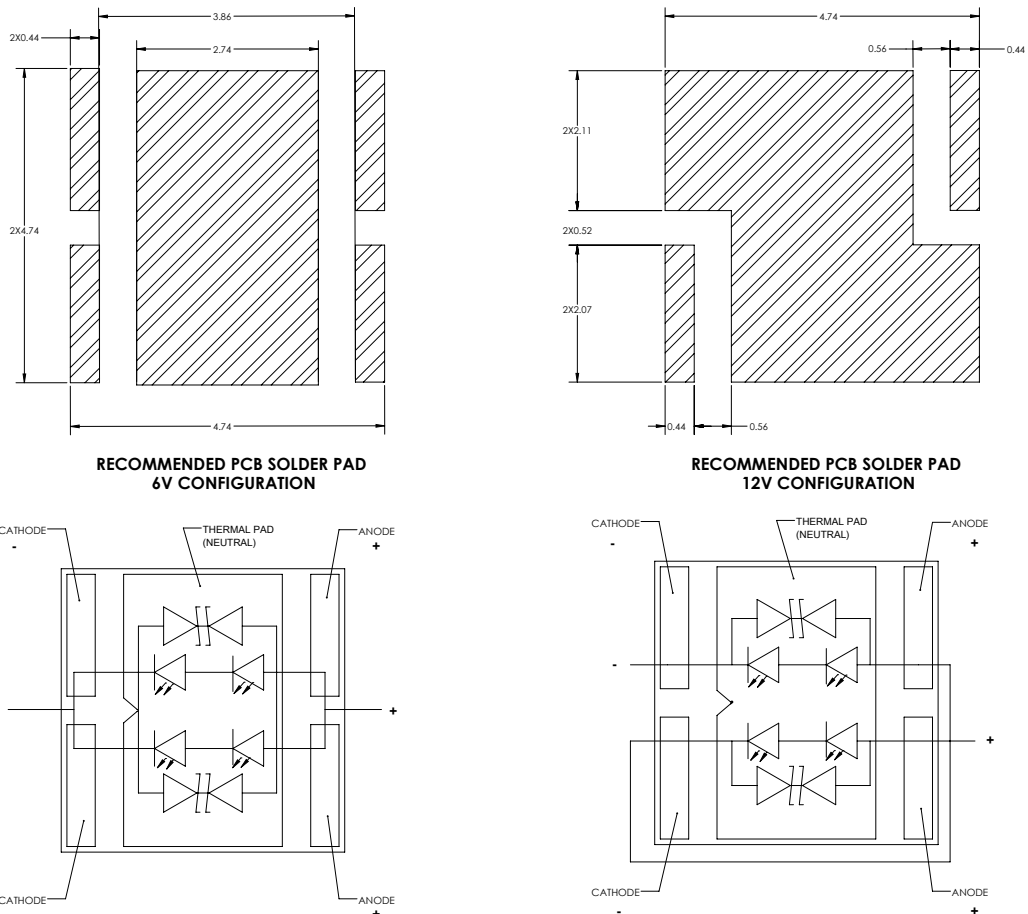

Tape and Reel

All dimensions are in millimeter ± 0.13 mm

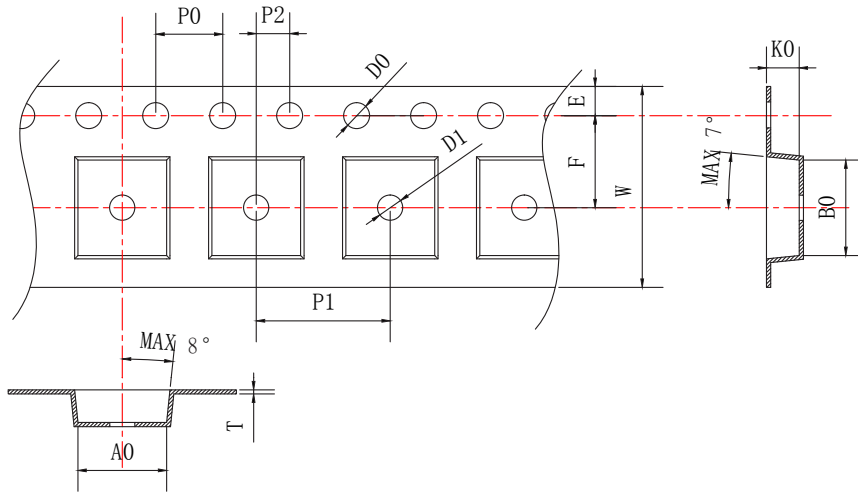

Parameter	Dimension (mm)
A0	5.3 \pm 0.1
B0	5.3 \pm 0.1
D0	1.5 \pm 0.1
D1	1.5 \pm 0.25
E	1.75 \pm 0.1
F	5.5 \pm 0.1
K0	1.7 \pm 0.1
P0	4.0 \pm 0.1
P1	8.0 \pm 0.1
P2	2.0 \pm 0.1
T	0.25 \pm 0.02
W	12+0.3 12-0.1

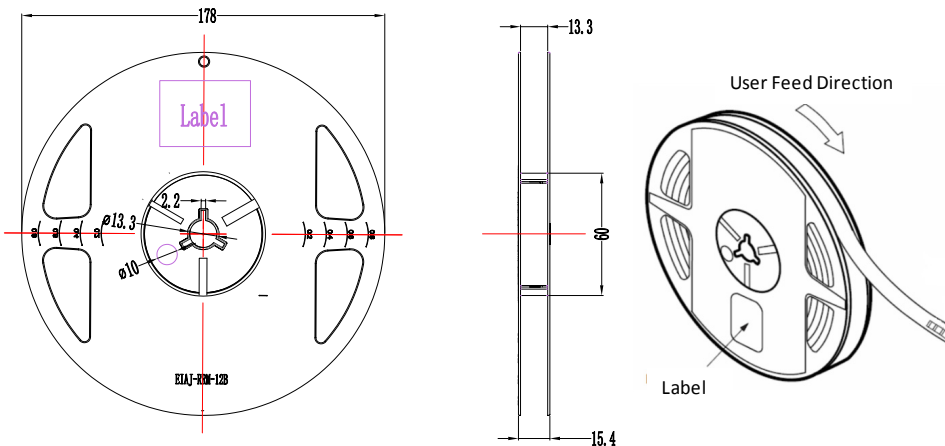

Notes:

1. Each Reel contains 500 units of LEDs.
2. Black anti-static tape material (Denka ECM3/ECAP3)
3. The accumulated tolerance for ten chain holes should be no more than 0.2 mm.
4. The tortuosity of 250 mm tape should be no more than 1 mm.
5. Leave 800 mm of type empty for lead in (100 empty pockets)
6. Leave 1200 mm of type empty for trailer (150 empty pockets)
7. All dimensions must comply to EIA-481-D
8. Final tape and reel packaging must meet the requirements of JEDEC-STD-033, LEVEL 2A.

Packaging and Labeling

Packaged Reel

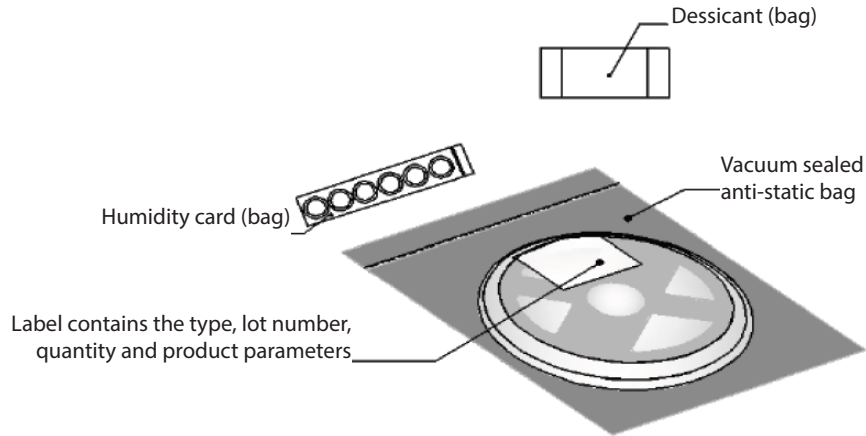

Label on Reel

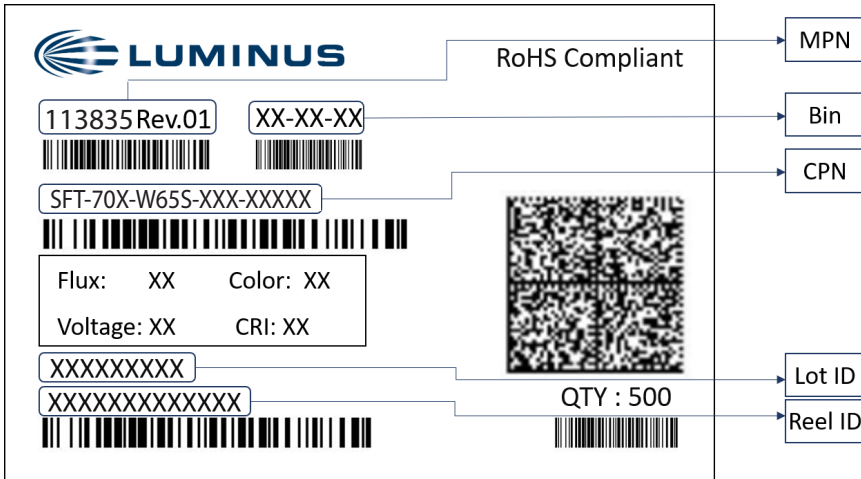

Label Information	
CPN	Luminus ordering part number
MPN	For Luminus internal use
QTY	Quantity of parts per reel
Flux	Single flux bin code (see <i>Luminous Flux Binning</i> table on page 3)
Voltage	V1
Color	Single chromaticity bin code (see <i>Chromaticity Bin Coordinates</i> table on page 4)
CRI	N/A
Lot ID & Reel ID	For Luminus internal use

Packaging Boxes

Box Size 1 - 5 reels per box
 Size: 22.5 x 24.5 x 6.5 cm

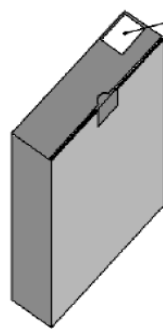
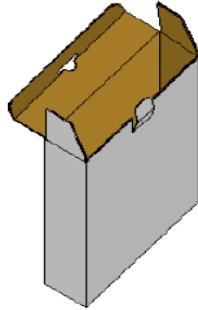

Label contains the type, lot number, quantity and product parameters

Box Size 2 - 10 reels per box
 Size: 22.5 x 24.5 x 13 cm

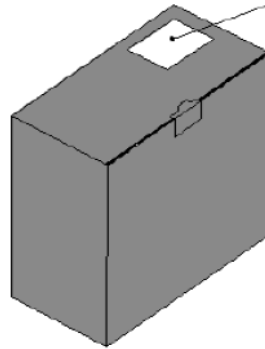
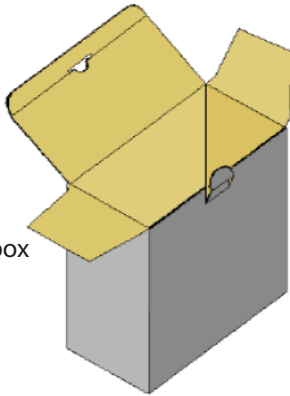

Label contains the type, lot number, quantity and product parameters

Shipping Label on Packaging Box

Multiple labels are attached to the box (one label per reel inside the box)

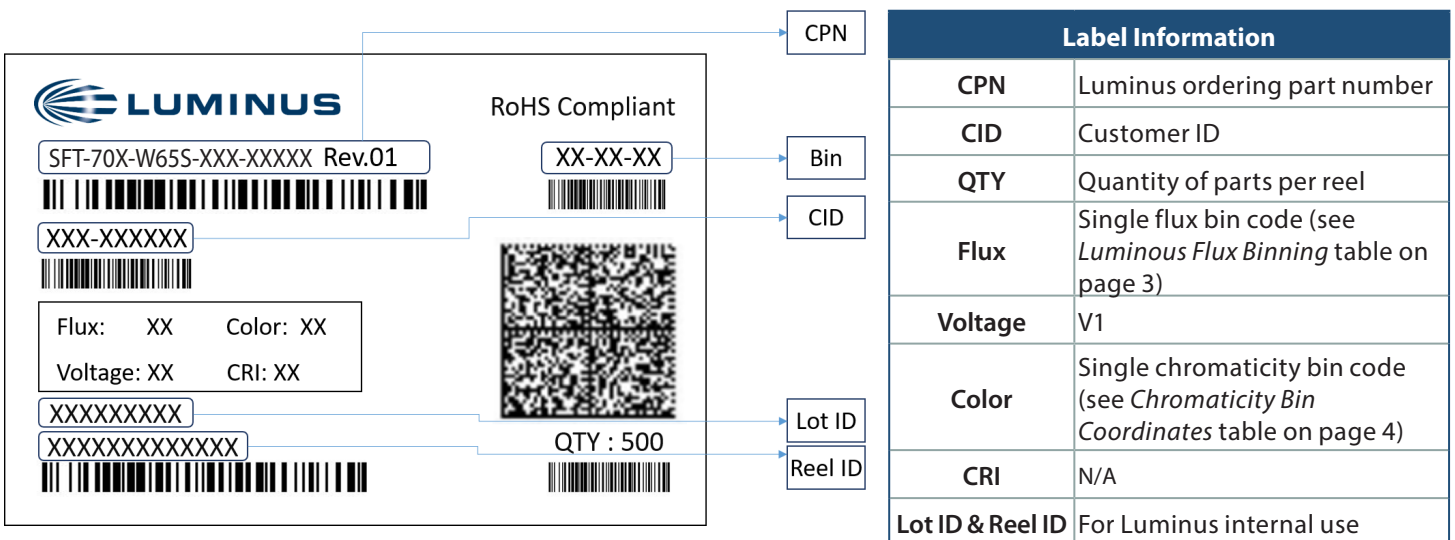

The shipping label contains the following information:

- LUMINUS** logo
- Part number: SFT-70X-W65S-XXX-XXXXX Rev.01
- RoHS Compliant
- Flux: XX Color: XX
- Voltage: XX CRI: XX
- Quantity: QTY : 500
- Barcode and QR code

Callouts from the label to the table:

- CPN (Customer Part Number)
- Bin
- CID (Customer ID)
- Lot ID
- Reel ID

Label Information	
CPN	Luminus ordering part number
CID	Customer ID
QTY	Quantity of parts per reel
Flux	Single flux bin code (see <i>Luminous Flux Binning</i> table on page 3)
Voltage	V1
Color	Single chromaticity bin code (see <i>Chromaticity Bin Coordinates</i> table on page 4)
CRI	N/A
Lot ID & Reel ID	For Luminus internal use

X-ON Electronics

Largest Supplier of Electrical and Electronic Components

Click to view similar products for [High Power LEDs - White category](#):

Click to view products by [Luminus Devices manufacturer](#):

Other Similar products are found below :

[LTW-K140SZR40](#) [LTPL-P00DWS57](#) [LTW-K140SZR30](#) [LZP-D0WW00-0000](#) [JK2835AWT-00-0000-000B0HL227E-BLK](#) [LTW-K140SZR57](#) [LTW-K140SZR27](#) [BXRC-35E10K0-D-73](#) [MP-5050-6100-65-80](#) [KW CSLPM2.CC-8L8M-4L8N](#) [KW CSLPM2.CC-8L8M-4O9Q](#) [KW DPLS32.SB-6H6J-E5P7-EG-Z264](#) [L1V1-507003V500000](#) [BXRE-27E1000-C-83](#) [BXRE-27G0800-D-83](#) [BXRE-27G2000-B-83](#) [BXRE-50C2001-C-84](#) [BXRH-35S1001-B-73](#) [BXRH-30E0300-B-83](#) [BXRH-30E1000-G-83](#) [115780](#) [LM1311D4W-12B4C12\(Ra4\)-DS](#) [ELJU\(9\)-K40M3-0LTHE-R4000](#) [ELJU\(9\)-K40M3-0LTHE-R3000](#) [LM1311D4W-12B2C24\(Ra4\)-DS](#) [KW2 CFLNM2.TK-D2D9-4L07M0-SC6B](#) [XEGAWT-H2-0000-000-00000UT122G](#) [XHP35B-H0-0000-0D0ZA230G](#) [XHP35B-H0-0000-0D0ZA440G](#) [XHP35B-H0-0000-0D0ZA227G](#) [XHP35B-H0-0000-0D0ZA235G](#) [CTM-9-4018-90-36-TWD6-F3-3](#) [CVM-32-56-95-54-AC00-F2-2](#) [SST-12-W65S-A120-H4652](#) [CXM-4-24-90-18-AC40-F5-2](#) [CXM-4-22-90-18-AC40-F5-2](#) [LM002H384W-7B3C12\(Ra5\)\(ANSI-2700K\)](#) [LM002H384W-9B4C12\(Ra2\)\(ANSI-2700K\)](#) [LM002H384W-7B3C12\(Ra7\)\(ANSI-2700K\)](#) [LM002H384W-9B4C12\(Ra2\)\(ANSI-3000K\)](#) [LM002H384W-9B4C12\(Ra4\)-S\(ANSI-3500K\)](#) [LM002H384W-9B4C12\(Ra5\)\(ANSI-4000K\)](#) [LM002H384W-7B3C12\(Ra2\)-S\(ANSI-3000K\)](#) [LM002H384W-7B3C12\(Ra5\)\(ANSI-4000K\)](#) [LM002H384W-7B3C12\(Ra7\)\(ANSI-4000K\)](#) [HL-LM002H384W-5B2C5\(Ra4\)\(ANSI-3000K\)](#) [HL-LM002H384W-7B1C18\(Ra4\)\(ANSI-6000K\)](#) [LM002H384W-7B3C12\(Ra5\)\(ANSI-3500K\)](#) [HL-LM002H384W-5B2C5\(Ra4\)\(ANSI-4000K\)](#) [HL-LM002H384W-5B2C5\(Ra4\)\(ANSI-6000K\)](#)