

SST-90-R LEDs

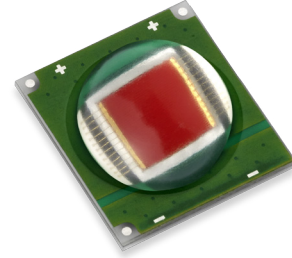

Table of Contents

Technology Overview2

Test Specifications2

Binning Structure3

Part Number Nomenclature 4

Product Shipping & Labeling Information.....5

Optical & Electrical Characteristics6

Thermal Resistance9

Mechanical Dimensions .. 10

Solder Profile 13

History of Changes 14

Features:

- Extremely high optical output Red LEDs: Typ.1500 lumens at 9A
- High thermal conductivity package - junction to case thermal resistance of only 0.5 °C/W
- Large, monolithic chip with uniform emitting area of 9 mm²
- Environmentally friendly: RoHS compliant
- Variable drive currents: less than 1 A through 18 A continuous waveform
- High reliability
- Electrically isolated thermal path

Applications

- Machine vision
- High-output strobing applications
- Beacons, obstruction lighting
- Industrial Applications
- Consumer Portable
- Medical Lighting
- Emergency Vehicle Lighting
- Displays and Signage
- High-output, directional transportation lighting
- Search Light

Technology Overview

Luminus LEDs™ benefit from a suite of innovations in the fields of chip technology, packaging and thermal management. These breakthroughs allow illumination engineers and designers to achieve solutions that are high brightness and high efficiency.

Luminus Technology

Luminus' technology enables large area LED chips with uniform brightness over the entire LED chip surface. The optical power and brightness produced by these large monolithic chips enable solutions which replace arc and halogen lamps where arrays of traditional high power LEDs cannot.

Packaging Technology

Thermal management is critical in high power LED applications. With a thermal resistance from junction to case of 0.5°C/W. Luminus SST-90 LEDs have the lowest thermal resistance of any LED on the market. This allows the LED to be driven at higher current densities while maintaining a low junction temperature, thereby resulting in brighter solutions and longer lifetimes.

Reliability

Designed from the ground up, Luminus LEDs are one of the most reliable light sources in the world today. Luminus LEDs have passed a rigorous suite of environmental and mechanical stress tests, including mechanical shock, vibration, temperature cycling and humidity, and have been fully qualified for use in extreme high power and high current applications. With very low failure rates and median lifetimes that typically exceed 60,000 hours, Luminus LEDs are ready for even the most demanding applications.

Environmental Benefits

Luminus LEDs help reduce power consumption and the amount of hazardous waste entering the environment. All LED products manufactured by Luminus are RoHS compliant and free of hazardous materials, including lead and mercury.

Understanding Luminus LED Test Specifications

Every Luminus LED is fully tested to ensure that it meets the high quality standards expected from Luminus' products.

Testing Temperature

Luminus surface mount LEDs are typically tested with a 20mSec input pulse and a junction temperature of 25°C. Expected flux values in real world operation can be extrapolated based on the information contained within this product data sheet.

Multiple Operating Points (3.15, 9.0 A and above)

The tables on the following pages provide typical optical and electrical characteristics. Since the LEDs can be operated over a wide range of drive conditions (currents from less than 1.0 A to 18.0 A, and duty cycle from <1% to 100%), multiple drive conditions are listed.

SST-90 LEDs are production tested at 3.15 A. The values shown at 9.0 A are for additional reference at other possible drive conditions.

SST-90 Red Bins Structure^{1,2}

SST-90 Red LEDs are specified for luminous flux and wavelength at a drive current of 3.15 A (0.35 A/mm²) and placed into one of the following luminous flux (FF) and wavelength (WW) bins:

Flux Bins

Color	Luminous Flux Bin (FF)	Minimum Flux (lm) @ 3.15A	Maximum Flux (lm) @ 3.15A
Red	BG	275	350
	BH	350	475
	BJ	475	600
	BK	600	770
	BM	770	970

Wavelength Bins

Color	Wavelength Bin (FF)	Minimum Wavelength @ 3.15A	Maximum Wavelength @ 3.15A
Red	R2	611	615
	R3	615	619
	R4	619	623
	R5	623	627

Note 1: Luminus maintains a +/- 6% tolerance on flux measurements.

Note 2: Only specific bins are available for large order, contact Luminus sales team for more information.

Part Number Nomenclature

SS<X> — 90 — <Y> — <Z>11 — <abnnn>

Product Family	LED Emission Area	Color	Package Configuration	Bin kit
SST: Surface mount device, Encapsulated SSR: Surface mount device mounted on an aluminum star board	90: 9.0 mm ²	<Y>: Color R = Red	F11: 10.0 mm x 11.0 mm - Surface mount, shipped in 25 unit trays. R11: Surface mount device mounted on an aluminum star board	Flux and Chromaticity bin kit code - See available ordering codes below

SST-90 Bin Kit Order Codes

The following tables describe the bin kit ordering codes available for the SST-90 and SSR-90 products. Each bin kit specifies a minimum flux as well as specific chromaticity bins allowed. Please note that within each kit a maximum flux is not specified and as a result Luminus may ship any part meeting or exceeding the minimum flux specification. Shipments will always meet the listed chromaticity bins. For information on ordering bin kits not listed below, please contact Luminus or an official distributor.

Color	Luminous Flux		Wavelength Bins	Kit Number
	Bin Kit Flux Code	Min. Flux		
Red	HG	275	R2, R3, R4, R5	HG100
			R3, R4	HG102
	HH	350	R2, R3, R4, R5	HH100
			R3, R4	HH102
	HJ	475	R2, R3, R4, R5	HJ100
			R3, R4	HJ102

Product Shipping & Labeling Information³

All SST-90 products are packaged and labeled with their respective bin as outlined in the tables on page 4. When shipped, each package will only contain one flux and chromaticity bin.

The part number designation is as follows:

SST — 90 — X — F11 — FF — WW

Product Family	Chip Area	Color	Package Configuration	Flux Bin	Wavelength Bin
Surface Mount (Lens)	9.0 mm ²	R: Red	F11: Surface mount, shipped in 25 unit trays. R11: Surface mount Starboard PCB, shipped in trays.	See page 3 for bins	See page 3 for bins

Example:

The part number SST-90-R-F11-BJ-R3 refers to a red, SST-90 surface mount, with a flux range of 475-600 lumens and a wavelength range of 615 nm to 619 nm.

Note 3: Some flux and chromaticity/wavelength bins may have limited availability. Application specific bin kits, consisting of multiple bins, may be available. For ordering information, please refer to pages 4 and 5.

Optical & Electrical Characteristics^{4,5}

Red					
Drive Condition ⁵		3.15 A Continuous	9.0 A Continuous		
Parameter	Symbol	Values ⁶		Unit	
Current Density	j	0.35	1.0	A/mm ²	
Forward Voltage	V _{Fmin}	1.8	-	V	
	V _F	2.1	2.5	V	
	V _{Fmax}	2.8	-	V	
Radiometric Power	Φ _{r,typ}	2.4	6.4	W	
Luminous Flux ⁷	Φ _{v,typ}	540	1500	lm	
Dominant Wavelength ⁷	λ _d	617	618	nm	
FWHM	Δλ _{1/2}	14	15	nm	
Chromaticity Coordinates ^{8,9} (Typ.)	x	0.685	0.687	-	
	y	0.315	0.313	-	

Relative Output Flux vs. Forward Current

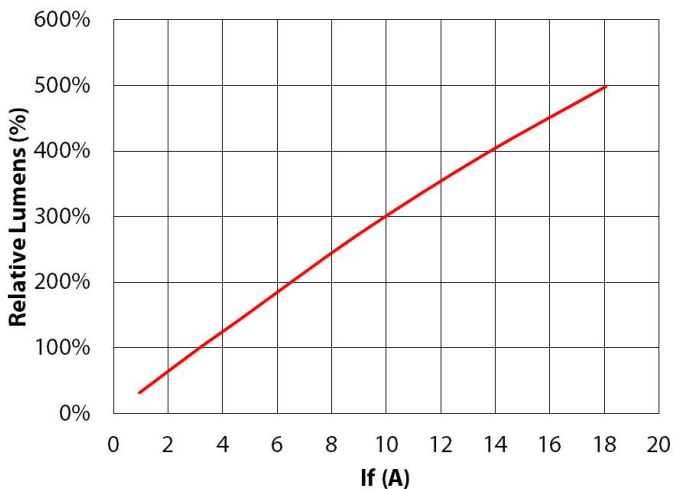
 20ms, single pulse, T_j=25C

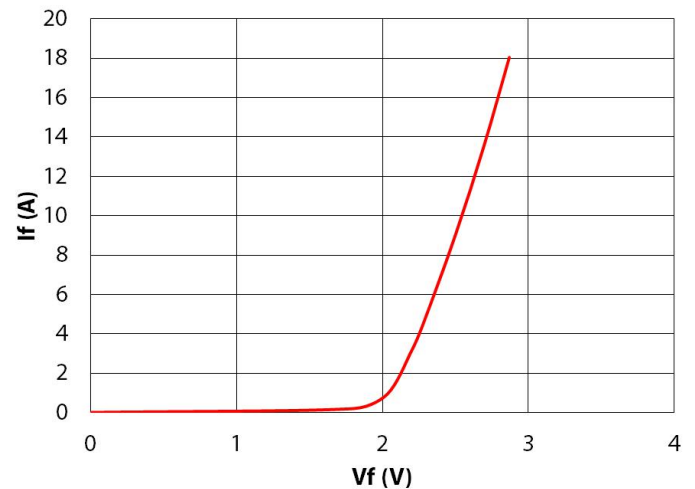
Forward Current vs. Forward Voltage

 20ms, single pulse, T_j=25C

Notes: See page 7

Optical & Electrical Characteristics Notes

- Note 4: All ratings are based on a junction test temperature $T_j = 25^\circ\text{C}$. See Thermal Resistance section for T_j definition.
- Note 5: Listed drive conditions are typical for common applications. SST-90 R devices can be driven at continuous currents ranging from <1.0 A to 9.0 A and at duty cycles ranging from 1% to 100%. Drive current and duty cycle should be adjusted as necessary to maintain the junction temperature desired to meet application lifetime requirements.
- Note 6: Unless otherwise noted, values listed are typical. Devices are production tested and specified at 3.15A. Other values are for reference only.
- Note 7: Total flux from emitting area at listed dominant wavelength. Reported performance is included to show trends for a selected power level. For specific minimum and maximum values, use bin tables. For product roadmap and future performance of devices, contact Luminus.
- Note 8: In CIE 1931 chromaticity diagram coordinates, normalized to $X+Y+Z=1$.
- Note 9: For reference only.

Common Characteristics

	Symbol	Red	Unit
Emitting Area		9.0	mm ²
Emitting Area Dimensions		3.0x3.0	mmxmm
Dynamic Resistance	Ω_{dyn}	0.03	Ω
Thermal Coefficient of Photometric Flux		-0.96	%/ °C
Thermal Coefficient of Radiometric Flux		-0.52	%/ °C
Thermal Coefficient of Junction Voltage		-1.3	mV/ °C

Absolute Maximum Ratings

	Symbol	Red	Unit
Absolute Minimum Current (CW or Pulsed) ¹⁰	I_{fmin}	0.2	A
Absolute Maximum Current (CW) ¹¹	I_{fmax}	18	A
Absolute Maximum Surge Current (t=20ms, duty cycle <=25%) ¹¹		22.5	A
Absolute Maximum Junction Temperature ¹²	T_{jmax}	110	°C
Storage Temperature Range		-40/+100	°C

Note 10: Special design considerations must be observed for operation under 1A. Please contact Luminus for further information.

Note 11: SST-90 R LEDs are designed for operation to an absolute maximum current as specified above. Product lifetime data is specified at recommended forward drive currents. Sustained operation at or beyond absolute maximum currents will result in a reduction of device life time compared to recommended forward drive currents. Actual device lifetimes will also depend on junction temperature. Refer to the lifetime derating curves for further information. In pulsed operation, rise time from 10-90% of forward current should be larger than 0.5 microseconds.

Note 12: Lifetime dependent on LED junction temperature. Input power and thermal system must be properly managed to ensure lifetime. See charts on page 8 for further information.

Light Output and Spectral Characteristics Over Heat Sink Temperature

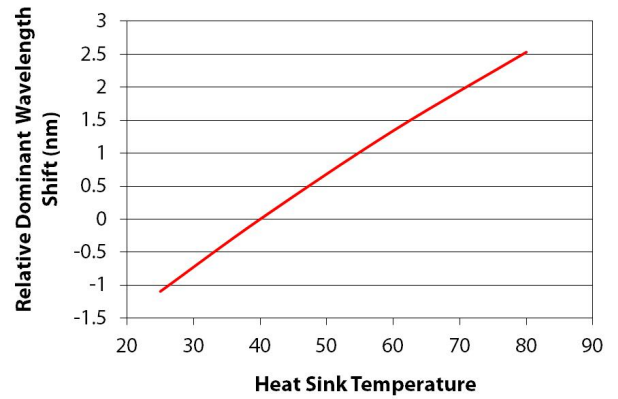
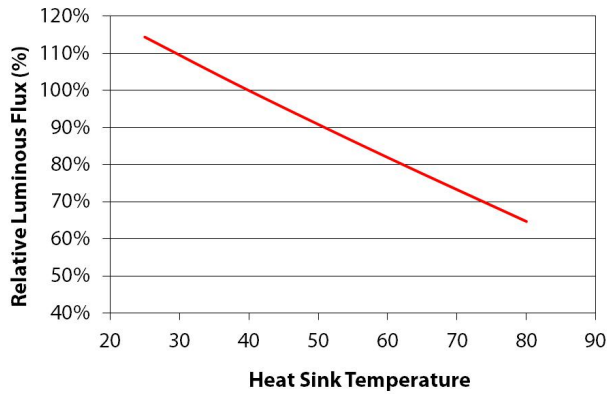

Median Lifetime Estimate vs. T_j ¹³

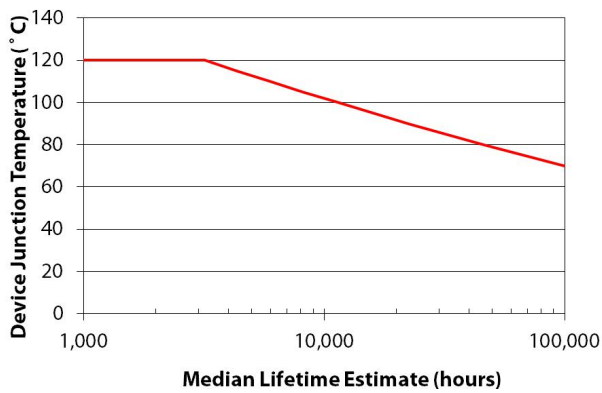

Lumen Maintenance¹⁴

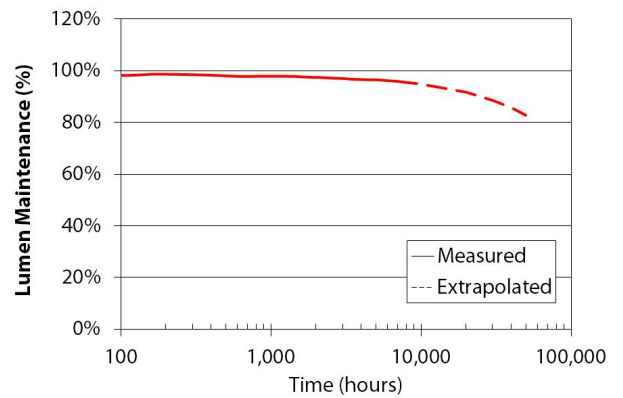

Typical Spectrum¹⁵

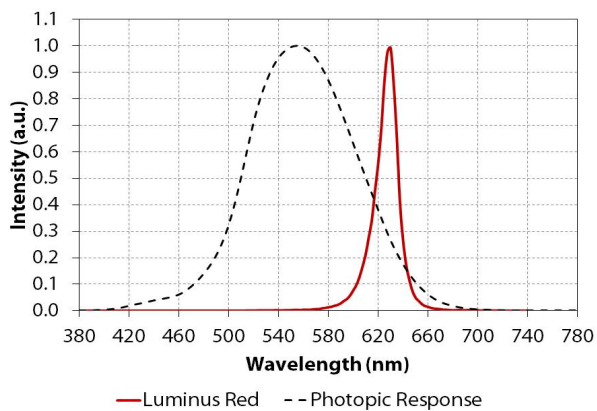

Note 13: Median lifetime estimate as a function of junction temperature at 0.35A/mm² in continuous operation. Lifetime defined as time to 70% of initial intensity. Based on preliminary lifetime test data. Data can be used to model failure rate over typical product lifetime.

Note 14: Lumen maintenance vs. time at 0.35A/mm² in continuous operation and junction temperature of 70°C.

Note 15: Typical spectrum at current density of 0.35 A/mm² in continuous operation.

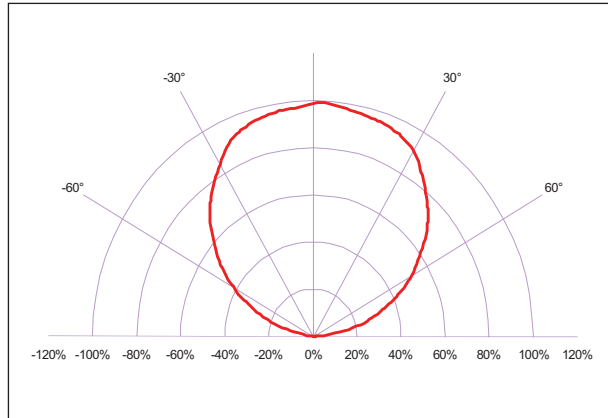
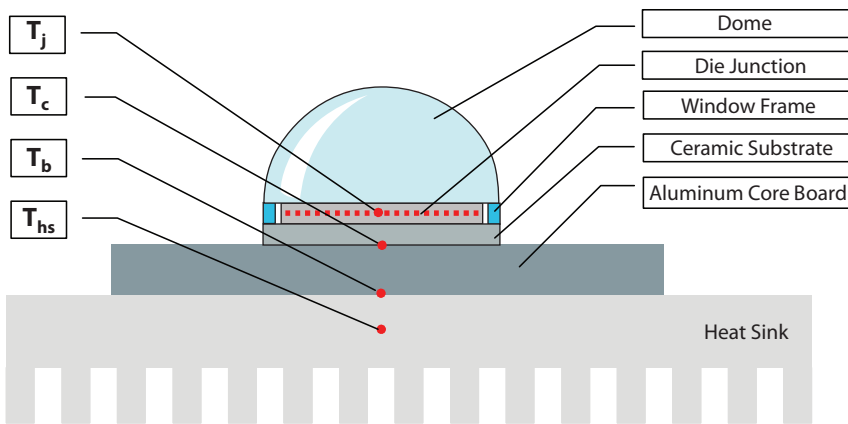
Typical Polar Radiation Pattern for Red

Thermal Resistance

T_{hs} definition = 3 mm from core-board

Typical Thermal Resistance^{16,17}

R_{j-c}^1	0.50 °C/W
R_{j-b}^1	1.20 °C/W
R_{j-hs}^2	1.40 °C/W

Note 16: Thermal resistance values are based on FEA model results correlated to measured $R_{\theta j-hs}$ data.

Note 17: Thermal resistance is measured using a SAC305 solder, a Bergquist Al-clad MCPCB, and eGraf 1205 thermal interface material.

Note: Luminus currently ships both an overmolded and a glass lens-based version of the SST-90 package that are functionally compatible

Mechanical Dimensions – SST-90 Over-Molded

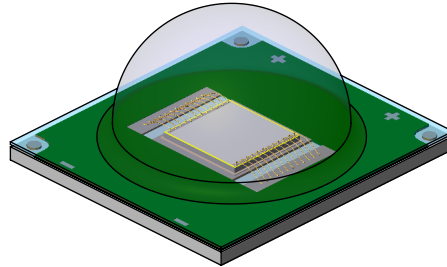

DIMENSIONS IN MILLIMETERS

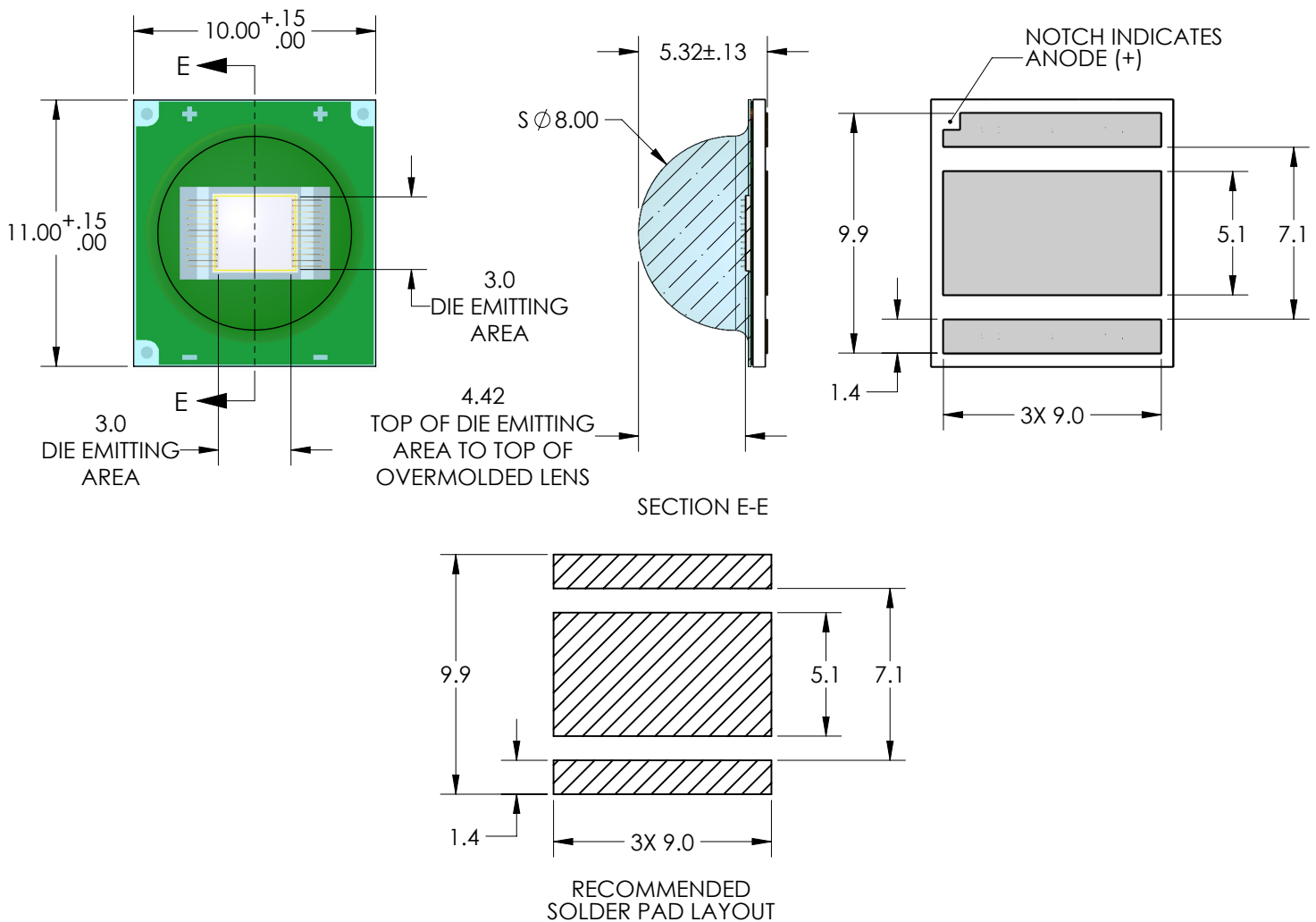

For detailed drawing please refer to DWG-002519 document

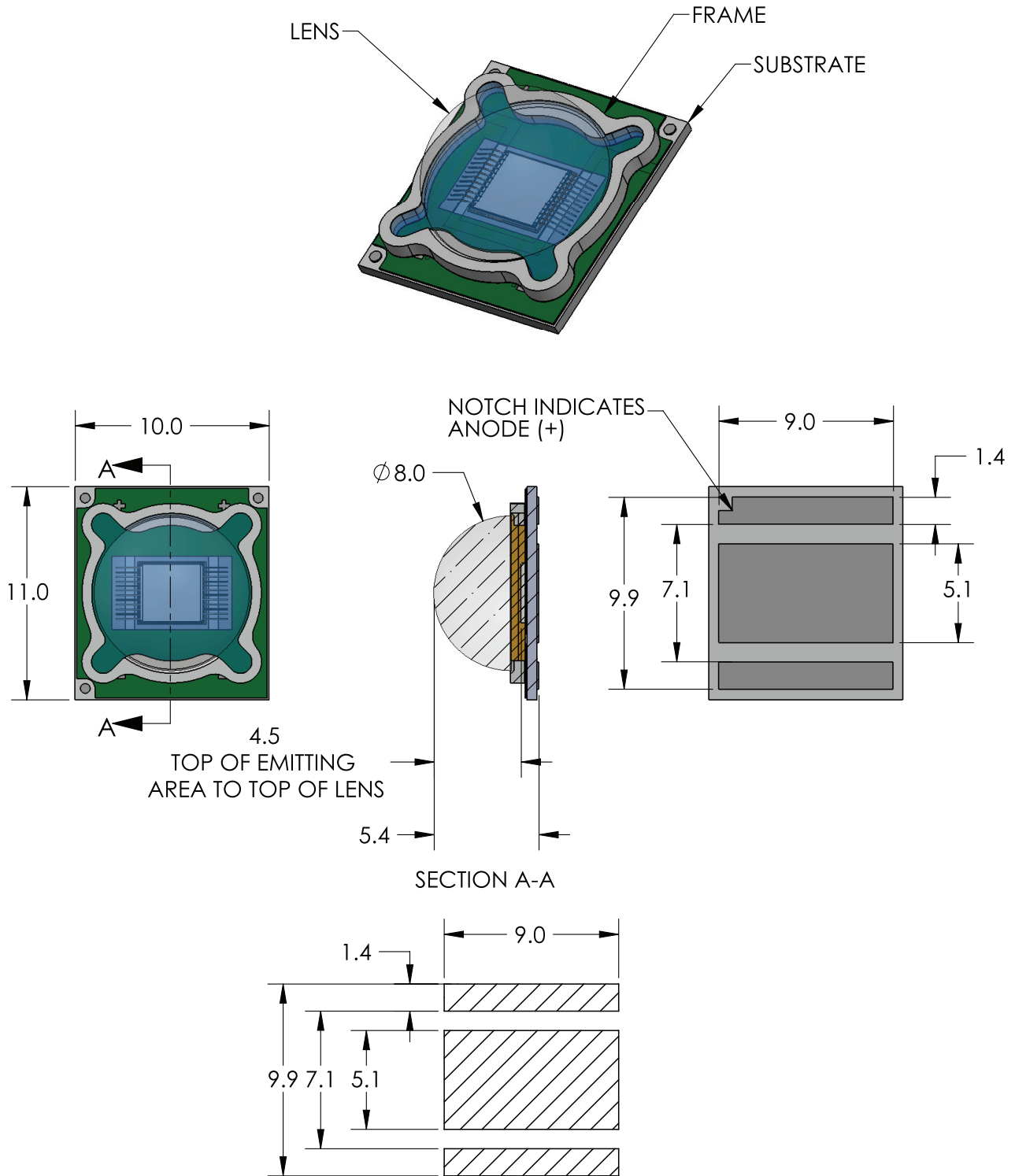
Mechanical Dimensions – SST-90 with metal frame and glass lens (Original Design)

For detailed drawing please refer to DWG-001359 document

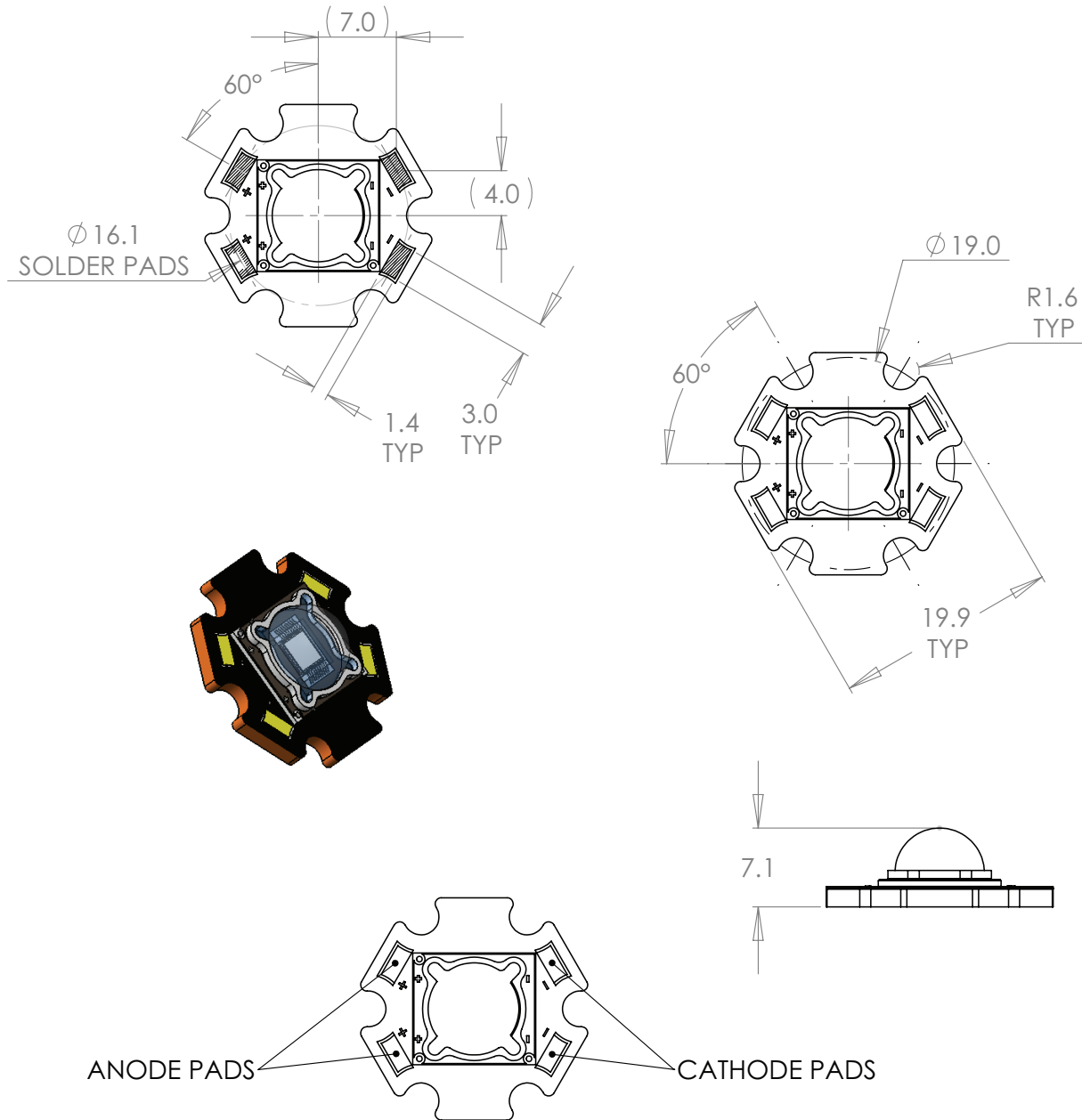
Mechanical Dimensions – SST-90 Star Board^{18,19,20}

Note 18: Recommended mounting screw: M3 or #4

Note 19: All dimensions in millimeters

Note 20: All anode pads on board are interconnected. All cathode pads on board are interconnected

Solder Profile

SAC 305 Reflow Profile Window For Low Density Boards

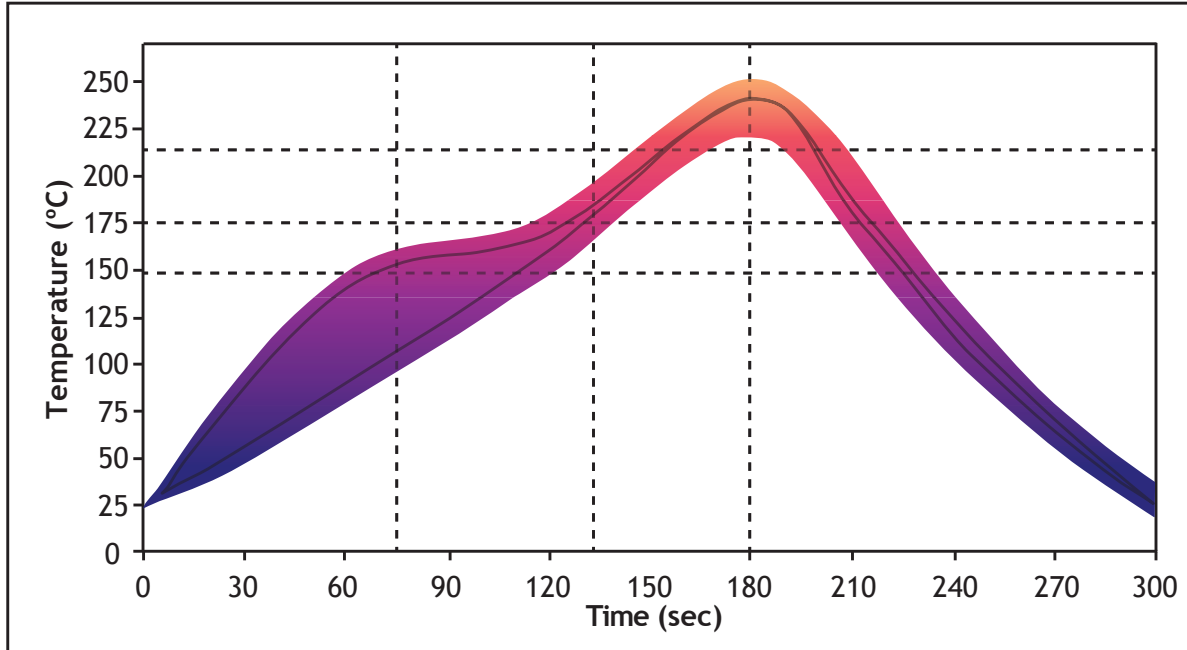

Lead free solder guideline for low density boards

Solder Profile Stage	Lead-Free Solder	Lead-based Solder
Profile length, Ambient to Peak	2.75 - 3.5 minutes	2.75 - 3.5 minutes
Time Maintained Above: Temperature	217 °C	183 °C
Time Maintained Above: Time	30 - 60 seconds	30 - 60 seconds
Cooldown Rate	≤4° C/sec	≤4° C/sec
Cooldown Duration	45 ± 15 sec	45 ± 15 sec

Note 21: Temperatures are taken and monitored at the component copper layer.

Note 22: Optimum profile may differ due to oven type, circuit board or assembly layout.

Note 23: Recommended lead free, no-clean solder: AIM NC254-SAC305.

Note 24: Refer to APN-001473 soldering and handling application note for additional solder profiles and details.

Note 25: MSL- Level 2A

History of Changes

Rev	Date	Description of Change
01	09/22/2015	<ul style="list-style-type: none">- Editorial fixes- Created separate new datasheet for SST-90-R (this datasheet) and removed from PDS-001342 Rev 14 (SST-90-W)- Added change history- Merged Binning and Labelling document (PDS-001692) into the product datasheet. PDS-001692 has been obsoleted.

The products, their specifications and other information appearing in this document are subject to change by Luminus Devices without notice. Luminus Devices assumes no liability for errors that may appear in this document, and no liability otherwise arising from the application or use of the product or information contained herein. None of the information provided herein should be considered to be a representation of the fitness or suitability of the product for any particular application or as any other form of warranty. Luminus Devices' product warranties are limited to only such warranties as accompany a purchase contract or purchase order for such products. Nothing herein is to be construed as constituting an additional warranty. No information contained in this publication may be considered as a waiver by Luminus Devices of any intellectual property rights that Luminus Devices may have in such information.

This product is protected by U.S. Patents 6,831,302; 7,074,631; 7,083,993; 7,084,434; 7,098,589; 7,105,861; 7,138,666; 7,166,870; 7,166,871; 7,170,100; 7,196,354; 7,211,831; 7,262,550; 7,274,043; 7,301,271; 7,341,880; 7,344,903; 7,345,416; 7,348,603; 7,388,233; 7,391,059 Patents Pending in the U.S. and other countries.

X-ON Electronics

Largest Supplier of Electrical and Electronic Components

Click to view similar products for [High Power LEDs - Single Colour category:](#)

Click to view products by [Luminus Devices manufacturer:](#)

Other Similar products are found below :

[GA CSSPM1.23-KTLP-W3-0-350-R18](#) [L135-L567003500000](#) [L1CU-VLT1000000000](#) [L1C1-VLT1000000000](#) [KY DDLM31.FY-8H7J-5F5G-W4A4-140-R18](#) [KY DDLM31.23-8F5H-36-C4U4-140-R18](#) [LS G6SP.01-7C8D-68-G3R3](#) [KT DDLM31.13-6H7J-36-W4A4-140-R18](#) [KS DDLM31.23-8E6G-68-C4U4-140-R18](#) [KB DDLM31.13-6D7E-25-24A4-140-R18](#) [GT CS8PM1.13-LSLU-26-1-350-B-R18](#) [XPEBRY-L1-0000-00S02](#) [SPHWH2L3D30ED4V0H3](#) [LUWCQ7P-LPLR-5E8G-1-K](#) [LTPL-C034UVH410](#) [XPEROY-L1-0000-00B02](#) [GD CSSPM1.14-UOVJ-W4-1](#) [LST1-01F06-GRN1-00](#) [KY DMLS31.23-8J7L-46-M3W3](#) [KY DMLQ31.23-HYKX-46-J3T3](#) [GD CS8PM1.14-UOVJ-W4-1](#) [XQEEPR-00-0000-000000A01-SB01](#) [LST1-01G01-UV02-00](#) [LST1-01F06-RYL1-00](#) [LST1-01F06-FRD1-00](#) [LST1-01G01-UV01-00](#) [LST1-01G01-PRD1-00](#) [XQEROY-00-0000-000000Q01-SB01](#) [LST1-01G01-UV03-00](#) [LST1-01G01-RYL1-00](#) [L135-A589003500000](#) [L135-L567L00000000](#) [L1C1-GRN1000000000](#) [LA G6SP-DAFA-24-1](#) [LS G6SP-CADB-1-1-Z](#) [LY H9PP-HZJZ-46-1](#) [SMTL6-RC](#) [MLEBLU-A1-0000-000U01](#) [MLEBLU-A1-0000-000U05](#) [MLEGRN-A1-0000-000101](#) [MLESRD-A1-0000-000W01](#) [XBDAMB-00-0000-000000701](#) [XBDAMB-00-0000-000000801](#) [XBDBLU-00-0000-000000201](#) [XBDBLU-00-0000-000000202](#) [XBDGRN-00-0000-000000B01](#) [XBDGRN-00-0000-000000C01](#) [XBDGRN-00-0000-000000C02](#) [XBDGRN-00-0000-000000D02](#) [XBDRDO-00-0000-000000801](#)