

# SST-10-G

## Green LED

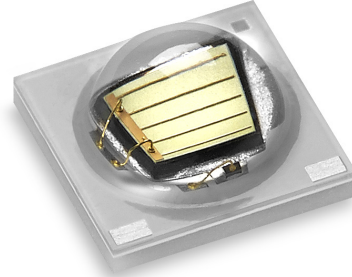

### Table of Contents

SST-10 Binning Structure . . .	2
Product Shipping & Labeling Information . . . . .	3
Optical and Electrical Characteristics . . . . .	4
B130 - Mech. Dimensions . . .	7
B130 - Tape and Reel . . . . .	8
B90 - Mech. Dimensions . . .	9
B90 - Tape and Reel . . . . .	10
Soldering Profile . . . . .	11
Precautions for Use . . . . .	12
History of Changes . . . . .	13

### Features:

- High Power Green LED with Peak Wavelength of 530nm
- Wall-Plug Efficiency: typ. 23% @350mA
- 90 or 130° viewing angle at 50% lv
- Low Thermal Resistance
- Built-in ESD Protection
- RoHS and REACH compliant

### Applications

- Horticulture / Growlights
- Accent and effect lighting
- Architectural lighting
- Stage lighting

## SST-10 Binning Structure

SST-10 Green LEDs are tested for luminous flux and chromaticity at a drive current of 350mA - 20ms single pulse and placed into one of the following luminous flux (FF) and chromaticity (WW) bins:

### Flux Bins - Test condition=350mA, 25°C, 20ms pulse

Flux Bin (FF)	Minimum Flux (mW)	Maximum Flux (mW)
E	190	230
F	230	270
G	270	310
H	310	350

### Wavelength Bins - Test condition=350mA, 25°C, 20ms pulse

Chromaticity Bin (WW)	Minimum Wavelength (nm)	Maximum Wavelength (nm)
G3	515	520
G4	520	525
G5	525	530
G6	530	535
G7	535	540

\*Note: Luminus maintains a +/- 6% tolerance on flux measurements.

## Ordering Information

Products	Ordering Part Number	Description
SST-10-G-B90	SST-10-G-B90-xx123	High Power 1-mm <sup>2</sup> Green LED in a 3535 surface mount package and a 90-degree lens
SST-10-G-B130	SST-10-G-B130-xx123	High Power 1-mm <sup>2</sup> Green LED in a 3535 surface mount package and a 130-degree lens

### Part Number Nomenclature

SST — 10 — <A> — <B###> — <FF###>

Product Family	LED Emission Area	Color	Package Configuration	Bin kit
SST: Surface Mount Package	10: 1.0 mm <sup>2</sup>	<A>: Color G = Green	B90: 90-degree lens B130: 130-degree lens	Flux and Chromaticity bin kit code - See available ordering codes below

### SST-10 Bin Kit Order Codes

The following table describes the bin kit ordering codes available for the SST-10 Green LEDs. Each bin kit specifies a minimum flux as well as specific chromaticity bins allowed. Please note that within each kit a maximum flux is not specified and as a result Luminus may ship any part meeting or exceeding the minimum flux specification. Shipments will always meet the listed chromaticity bins. For information on ordering bin kits not listed below, please contact Luminus.

#### SST-10 Green Bin Kit Order Codes

Color	Luminous Flux		Chromaticity Bins	Kit Number
	Bin Kit Flux Code	Min. Flux		
Green	E	190	G3,G4,G5,G6,G7	E530

### Product Shipping & Labeling Information

All SST-10 products are packaged and labeled with their respective bin as outlined in the tables on pages 2 & 3. Each reel will only contain one bin.

#### SST-10 Green

SST — 10 — G — BXXX — FFWW

Product Family	LED Emission Area	Color	Package Configuration	Bin kit
SST: Surface Mount Package	10: 1.0 mm <sup>2</sup>	Color	B90: 90-degree lens B130: 130-degree lens	Flux and Chromaticity bin kit code as outlined above

## Optical and Electrical Characteristics

### Optical and Electrical Characteristics at 350mA<sup>1</sup>

Parameter	Symbol	Minimum	Typical	Maximum	Unit
Forward Current <sup>2</sup>	$I_f$		350	1,500	mA
Output Power	$\Phi_r$		270		mW
Forward Voltage	$V_f$	2.8	3.4	4.0	V
Wall-Plug Efficiency	WPE		23		%
Viewing Angle	$2 \varnothing_{1/2}$		90 or 130		degrees
Peak Wavelength	$\lambda_p$	515	527	540	nm
FWHM	$\Delta\lambda_{1/2}$	30	33	36	nm
Thermal Resistance (Electrical)	$R_{TH}$		5.3		°C/W

### Absolute Maximum Ratings<sup>2</sup>

Parameter	Symbol	Rating	Unit
Forward Current <sup>3,4</sup>	I	1.5	A
Power Dissipation	$P_D$	5.0	W
Reverse Voltage	$V_R$	5	V
Storage Temperature	$T_{STG}$	-40~100	°C
Junction Temperature <sup>3,4</sup>	$T_J$	115 °C	°C
Soldering Temperature	$T_{SLD}$	JEDEC 020, 260 °C	
ESD Sensitivity (HBM)	$V_B$	6000	V

Note 1: Ratings are based on operation at a constant junction temperature of  $T_j = 25^\circ\text{C}$ .

Note 2: To prevent damage, please refer to operating conditions and derating curves for appropriate maximum operating conditions

Note 3: Maximum operating case temperature combined with maximum drive current defines the total maximum operating condition for the device. To prevent damage, please follow derating curves for all operating conditions.

Note 4: Luminus SST-10-Green LEDs are designed for operation up to an absolute maximum forward drive current as specified above. Product lifetime data is specified at typical forward drive currents. Sustained operation at absolute maximum currents will result in a reduction of device lifetime compared to typical forward drive currents. Actual device lifetimes will also depend on junction temperature. Refer to the current vs. junction temperature derating curves for further information. In pulsed operation, rise time from 10-90% of forward current should be larger than 0.5 microseconds.

Note 5: Caution must be taken not to stare at the light emitted from these LEDs. Under special circumstances, the high intensity could damage the eye.

## Optical and Electrical Characteristics

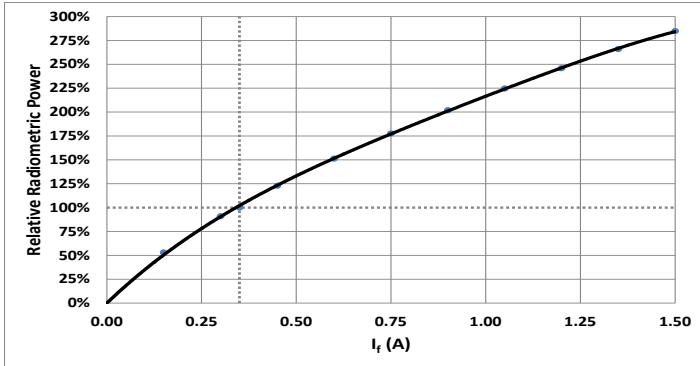
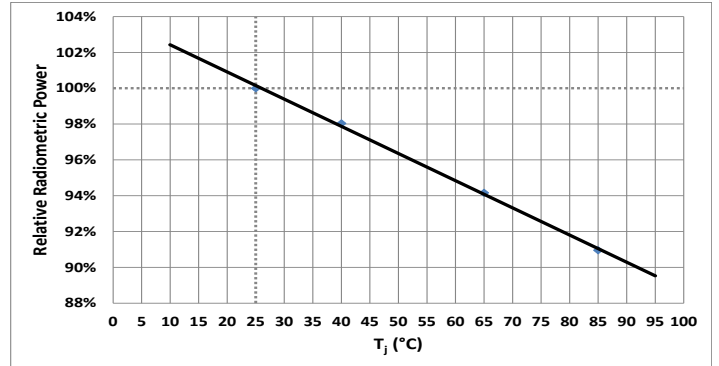
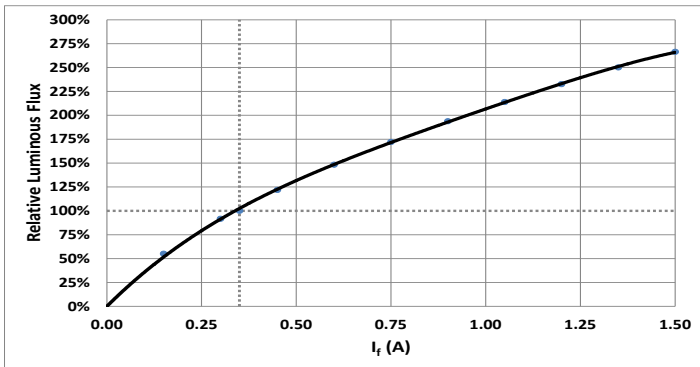
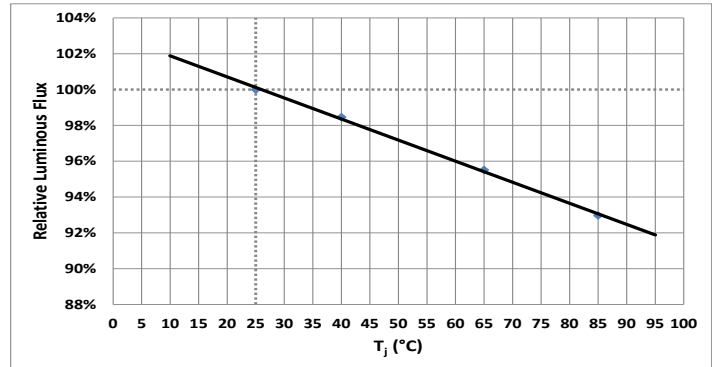
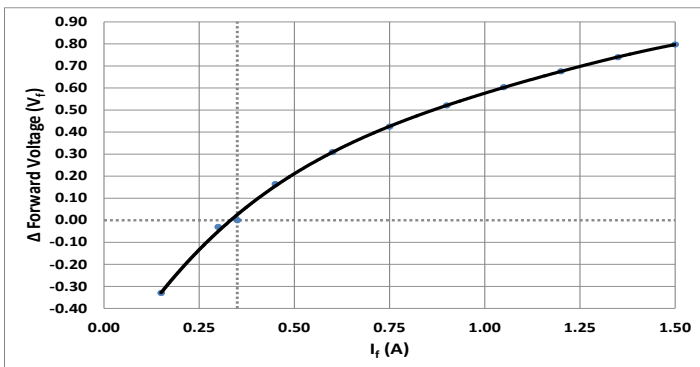
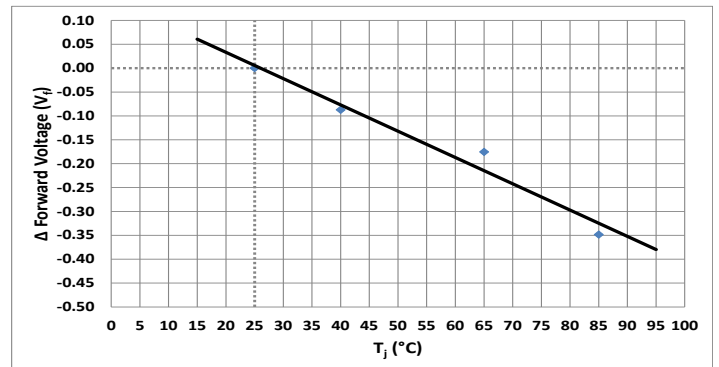
**Relative Radiometric Power vs. Forward Current**

**Relative Radiometric Power vs. Junction Temperature**

**Relative Lumens vs. Forward Current**

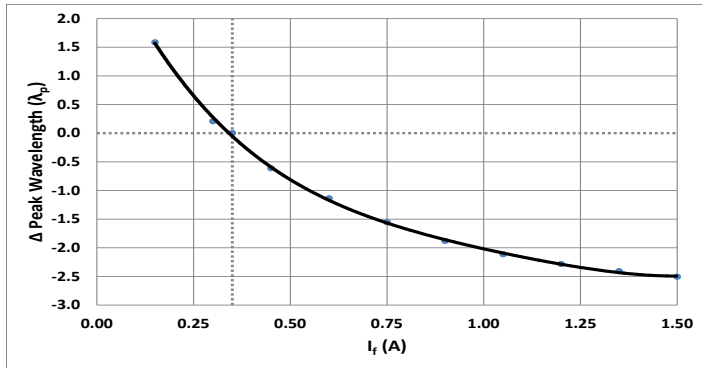
**Relative Lumens vs. Junction Temperature**

**Relative Forward Voltage vs. Forward Current**

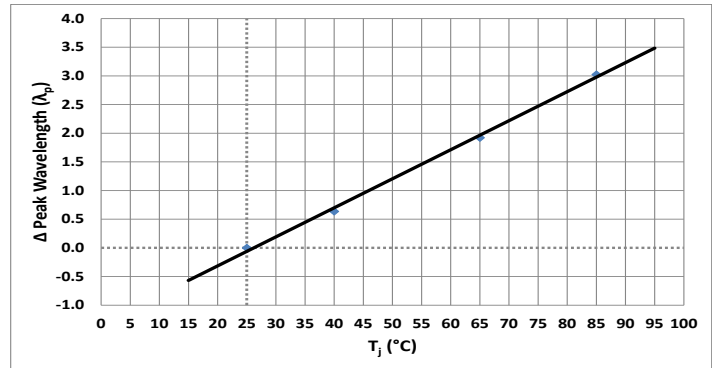
**Relative Forward Voltage vs. Junction Temperature**

## Optical and Electrical Characteristics

Relative Peak Wavelength vs. Forward Current



Relative Peak Wavelength vs. Junction Temperature



Typical Polar Radiation Plot - B130

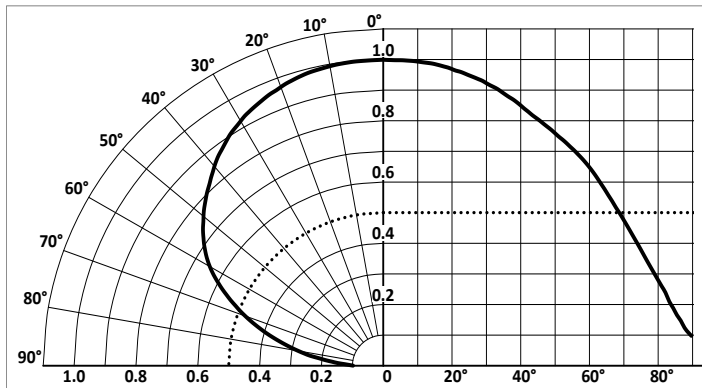

Typical Polar Radiation Plot - B90

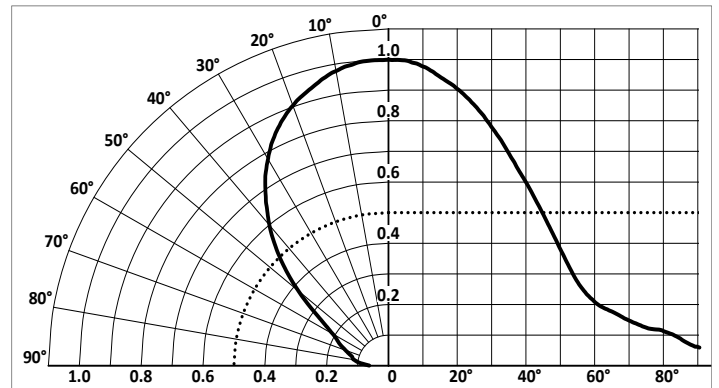

Typical Spectra

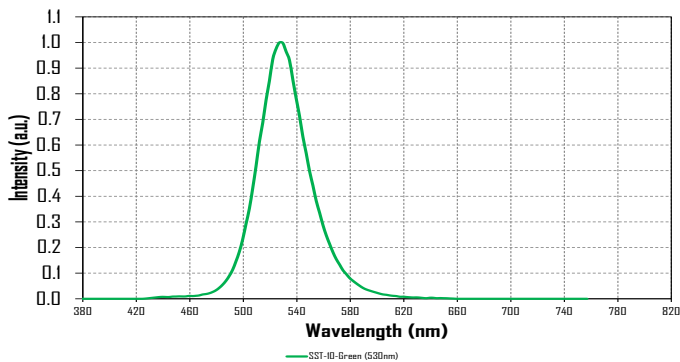

Conversion Table - Radiometric Power - Lumens

		Peak Wavelength (nm)					
		515	520	525	530	535	540
Flux bin (mW)	190 (E bin)	85 lm	93 lm	101 lm	108 lm	113 lm	117 lm
	230 (F bin)	103 lm	113 lm	122 lm	130 lm	136 lm	141 lm
	270 (G bin)	121 lm	133 lm	143 lm	153 lm	160 lm	166 lm
	310 (H bin)	139 lm	152 lm	165 lm	175 lm	184 lm	190 lm

### Mechanical Dimensions - B130 Package

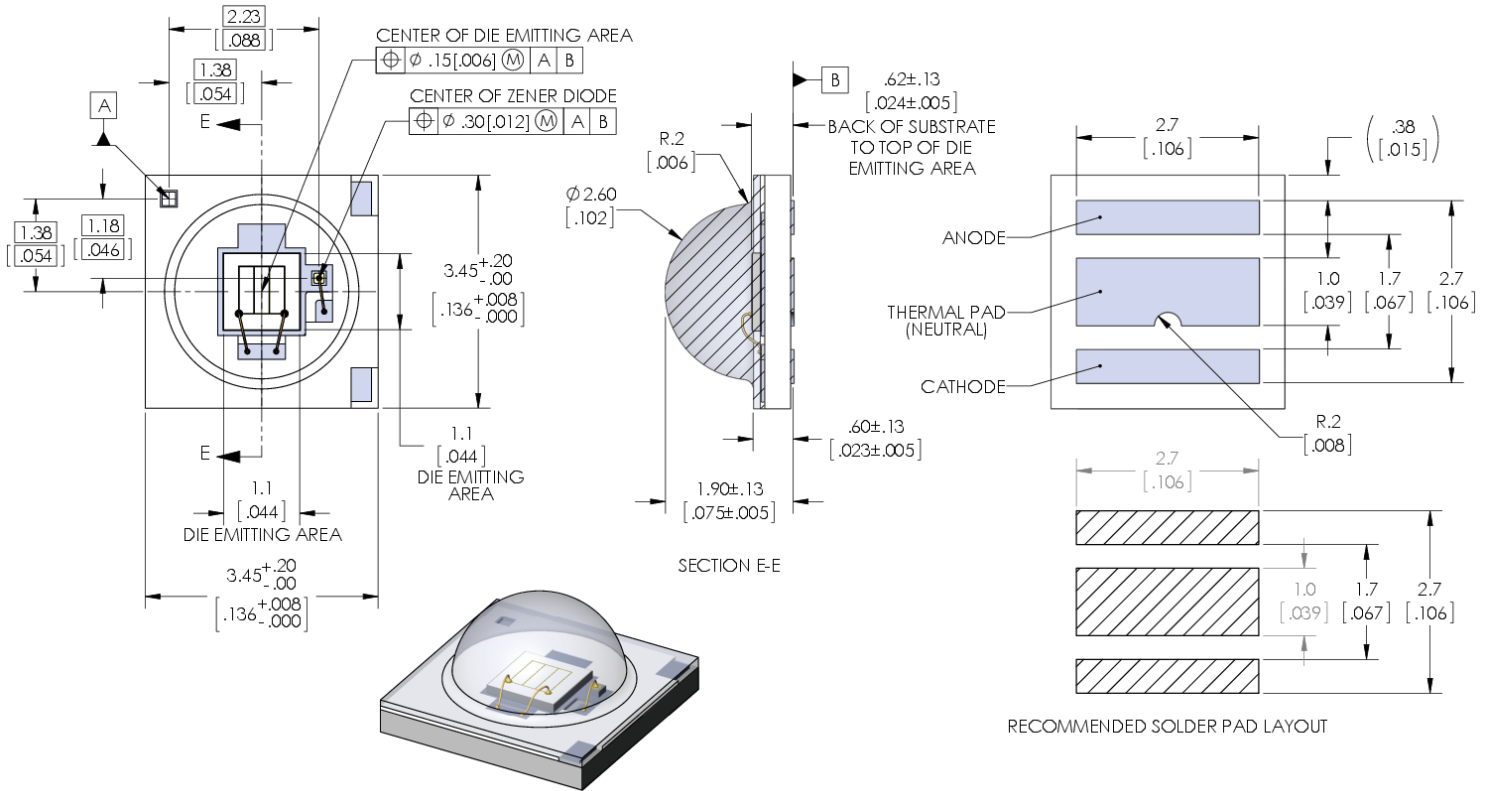

### Tape and Reel - B130 Package

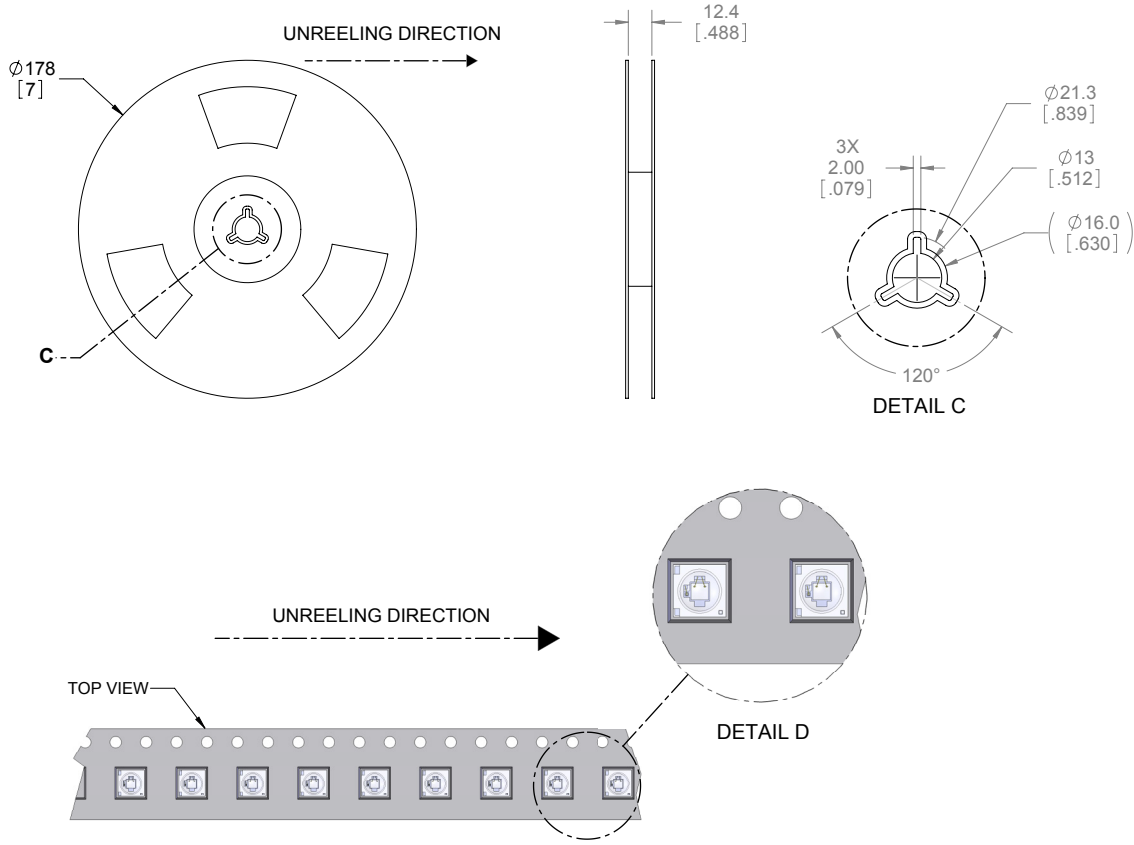
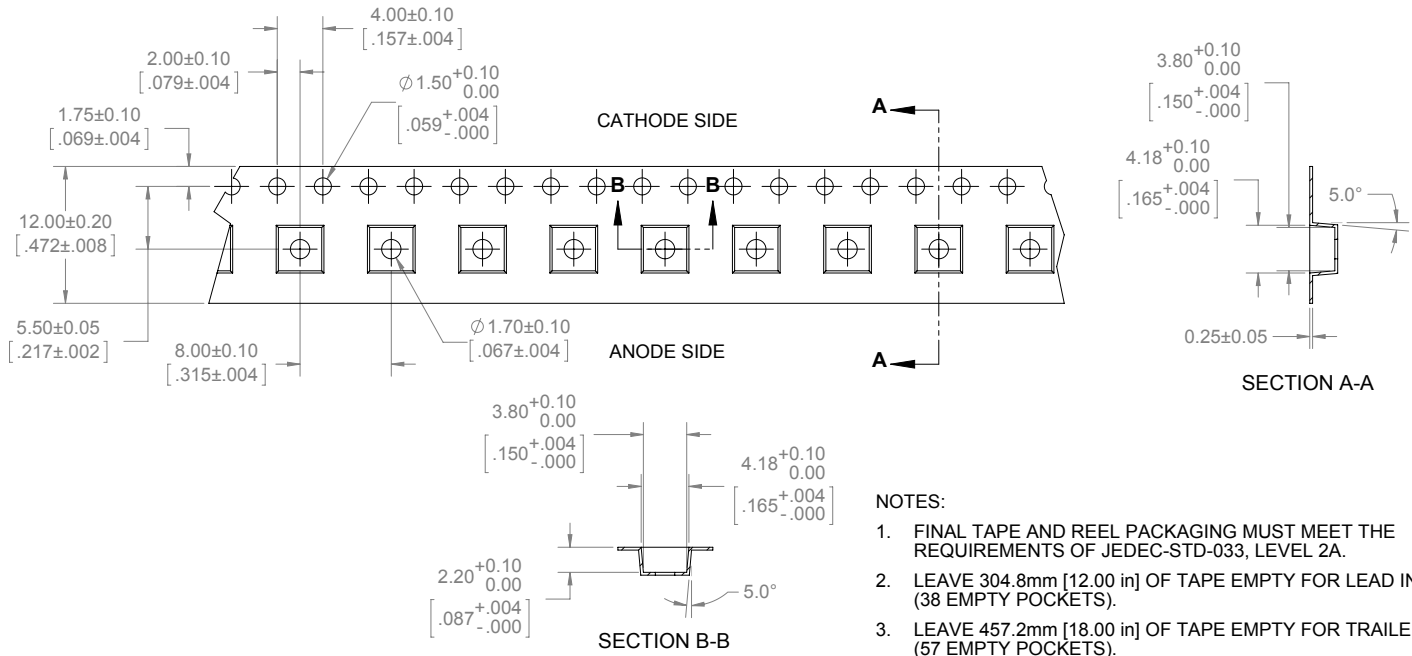



### Mechanical Dimensions - B90 Package

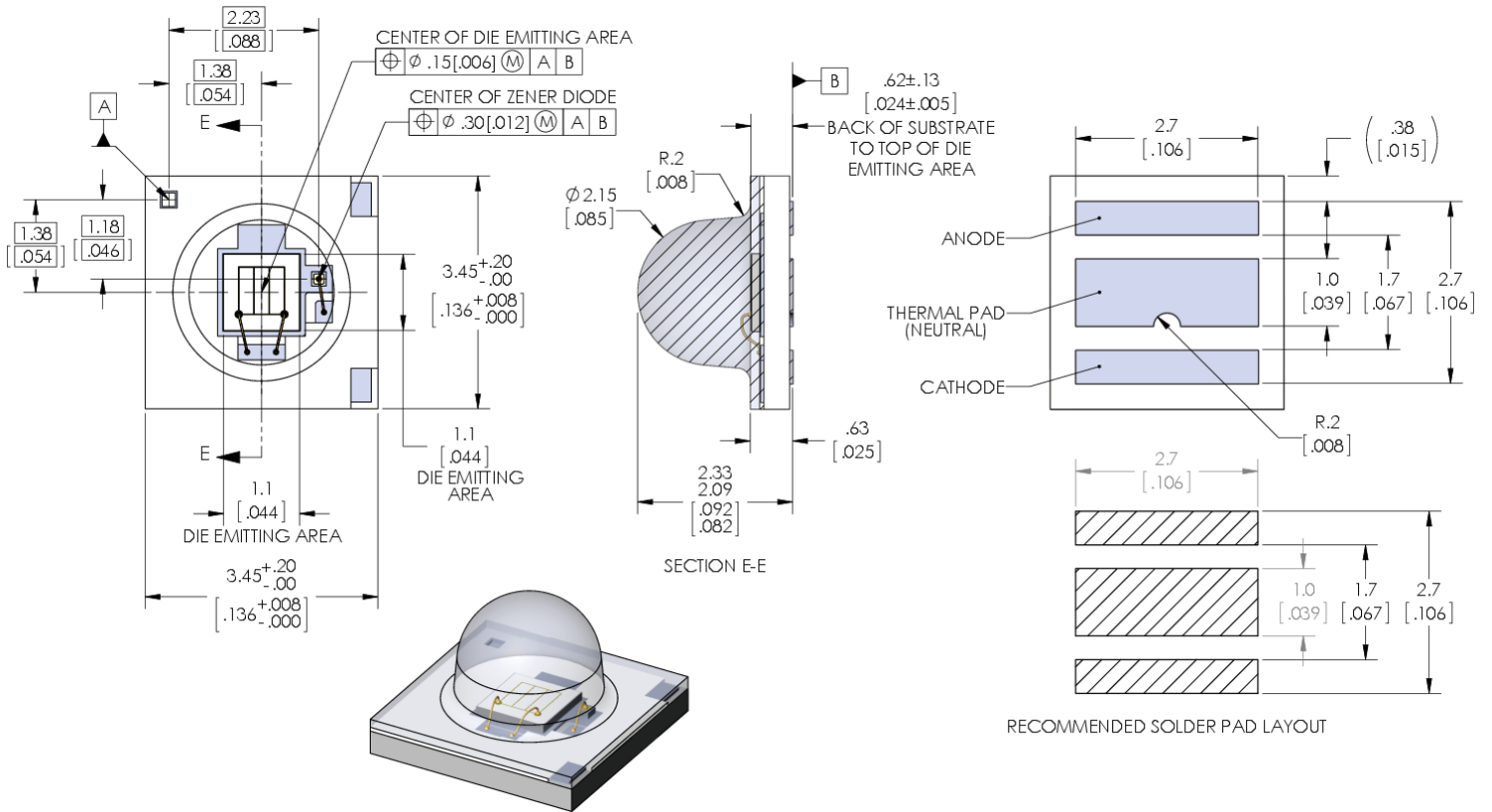

### Tape and Reel - B90 Package

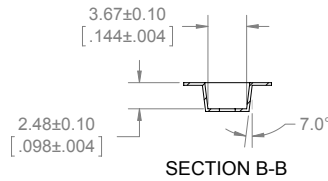
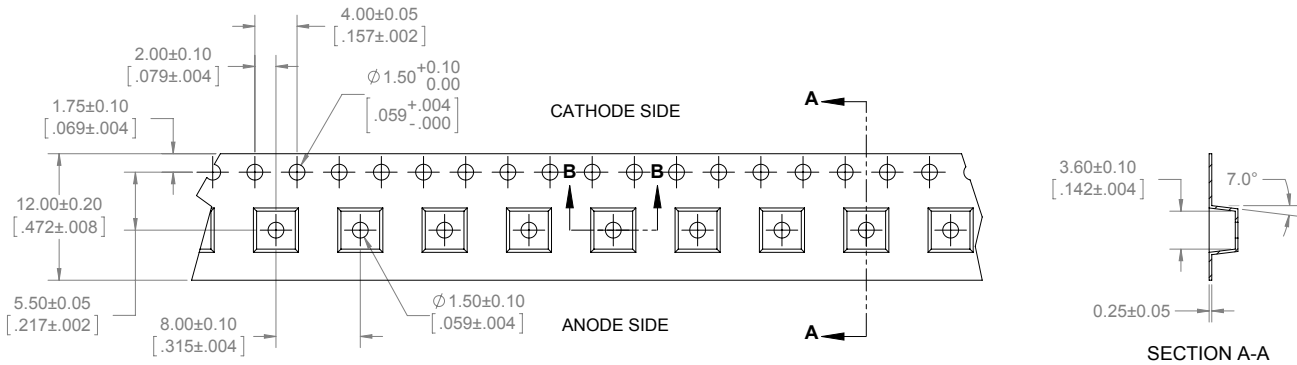

**NOTES:**

1. FINAL TAPE AND REEL PACKAGING MUST MEET THE REQUIREMENTS OF JEDEC-STD-033, LEVEL 2A.
2. LEAVE 304.8mm [12.00 in] OF TAPE EMPTY FOR LEAD IN (38 EMPTY POCKETS).
3. LEAVE 457.2mm [18.00 in] OF TAPE EMPTY FOR TRAILER (57 EMPTY POCKETS).
4. MUST COMPLY TO EIA-481-C-2003

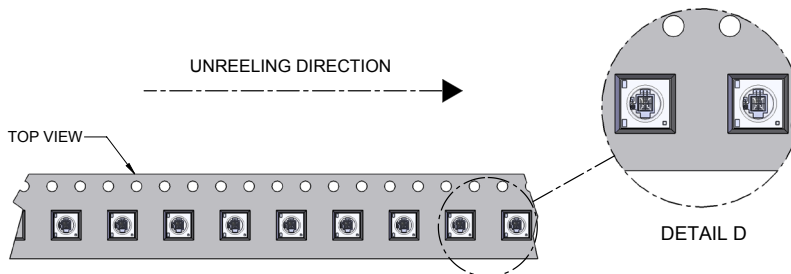
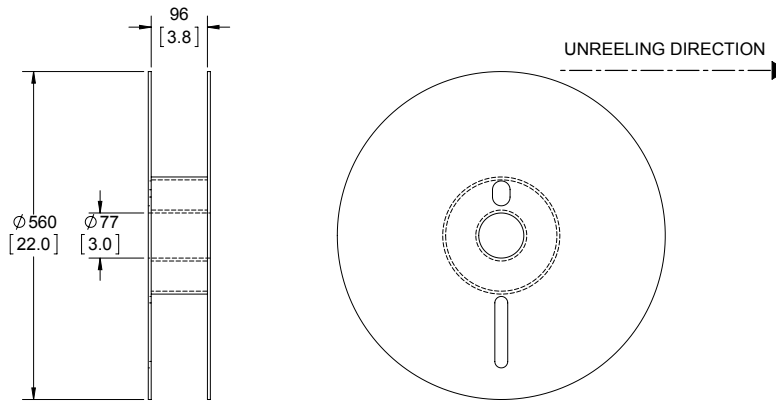

### Soldering Profile

Profile Feature	Sn-Pb Eutectic Assembly	Pb-Free Assembly
Preheat & Soak	100 °C	150 °C
Temperature min (T <sub>smin</sub> )	150 °C	200 °C
Temperature max (T <sub>smax</sub> )	60-120 seconds	60-120 seconds
Time (T <sub>smin</sub> to T <sub>smax</sub> ) (t <sub>s</sub> )		
Average ramp-up rate (T <sub>smax</sub> to T <sub>p</sub> )	3 °C/second max	3 °C/second max
Liquidous temperature (T <sub>L</sub> )	183 °C	217 °C
Time at liquidous (t <sub>L</sub> )	60-150 seconds	60-150 seconds
Peak package body temperature (T <sub>p</sub> )*	230 °C ~235 °C	255 °C ~260 °C
Classification temperature (T <sub>c</sub> )	235 °C	260 °C
Time (t <sub>p</sub> ) within 5 °C of the specified classification temperature (T <sub>c</sub> )	20 seconds	30 seconds
Average ramp-down rate (T <sub>p</sub> to T <sub>smax</sub> )	6 °C/second max	6 °C/second max
Time 25 °C to peak temperature	6 minutes max	8 minutes max

\* Tolerance for peak profile temperature(T<sub>p</sub>) is defined as a supplier minimum and a user maximum.

\*\* Tolerance for time at peak profile temperature(t<sub>p</sub>) is defined as a supplier minimum and a user maximum.

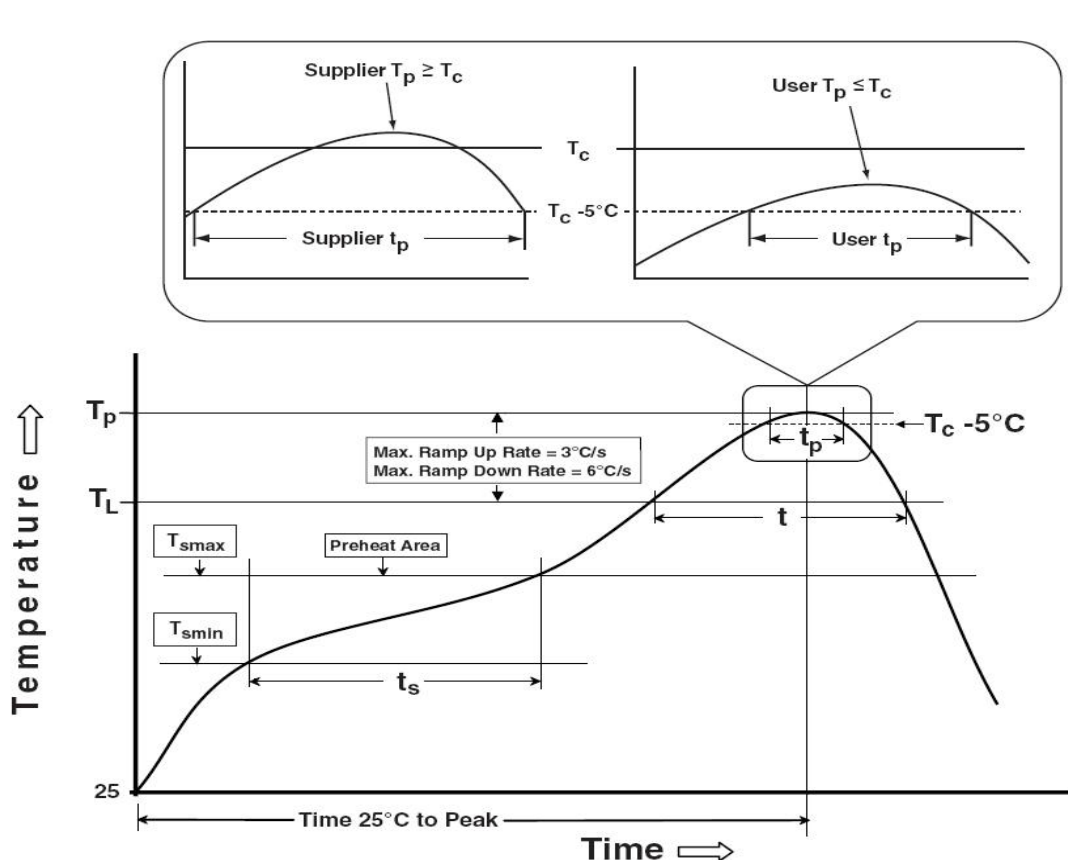

## Precautions for Use

### Storage:

#### 1. Before opening the package

The LEDs should be kept at a temperature lower than 40° C and relative humidity lower than 90%. The LEDs should be used within a year. When storing the LEDs, moisture proof package with absorbent material (silica gel) is recommended.

#### 2. After opening the package

The LEDs should be kept at temperature lower than 30° C and relative humidity lower than 60%. The LEDs should be soldered within 168 hours (7days) after opening the moisture proof package.

If unused LEDs remain, they should be stored in moisture proof packages, such as sealed containers with moisture proof package within absorbent material (silica gel). It is also recommended to return the unused LEDs to the original moisture proof package and to seal the moisture proof package again.

If the moisture absorbent material (silica gel) vapors or expires the expiration date, baking treatment should be performed by using the following conditions : 60 °C for 20 hours.

The LEDs electrode and leadframe comprise a silver plated copper alloy. The silver surface may be affected by environments. Please avoid conditions which may cause the LEDs to corrode or discolor. The corrosion or discoloration might lower solderability or affect optical characteristics.

Please avoid rapid transition in ambient temperature, especially in high humidity environments where condensation can occur.

### Static Electricity:

1. The products are sensitive to static electricity, and care should be taken when handling them.

2. Static electricity or surge voltage will damage the LEDs. It is recommended to wear a anti-electrostatic wristband or anti-electrostatic gloves when handling the LEDs.

3. All devices, equipment and machinery must be properly grounded. It is recommended that measures be taken against surge voltage to the equipment that mounts the LEDs.

### History of Changes

Rev		Description of Change
01	06/10/2016	Initial Release - Preliminary Specifications
02	04/03/2017	Updated title in "Relative Output Flux vs. Junction Temperature" graph and address.
03	03/23/2019	Updated and added graphs on pages 5 and 6. Added conversion table on page 6

## X-ON Electronics

Largest Supplier of Electrical and Electronic Components

*Click to view similar products for [High Power LEDs - Single Colour](#) category:*

*Click to view products by [Luminus Devices](#) manufacturer:*

Other Similar products are found below :

[GA CSSPM1.23-KTLP-W3-0-350-R18](#) [L135-L567003500000](#) [L1CU-VLT1000000000](#) [L1C1-VLT1000000000](#) [KY DDLM31.FY-8H7J-5F5G-W4A4-140-R18](#) [KY DDLM31.23-8F5H-36-C4U4-140-R18](#) [LS G6SP.01-7C8D-68-G3R3](#) [KR DDLM31.23-5G7H-25-C4U4-140-R18](#) [KT DDLM31.13-6H7J-36-W4A4-140-R18](#) [KS DDLM31.23-8E6G-68-C4U4-140-R18](#) [KB DDLM31.13-6D7E-25-24A4-140-R18](#) [GT CS8PM1.13-LSLU-26-1-350-B-R18](#) [XPEBRY-L1-0000-00S02](#) [SPHWH2L3D30ED4V0H3](#) [LUWCQ7P-LPLR-5E8G-1-K](#) [LTPL-C034UVH410](#) [XPEROY-L1-0000-00B02](#) [GD CSSPM1.14-UOVJ-W4-1](#) [LST1-01F06-GRN1-00](#) [KY DMLS31.23-8J7L-46-M3W3](#) [KY DMLQ31.23-HYKX-46-J3T3](#) [GD CS8PM1.14-UOVJ-W4-1](#) [XQEEPR-00-0000-000000A01-SB01](#) [LST1-01G01-UV02-00](#) [LST1-01F06-RYL1-00](#) [LST1-01F06-FRD1-00](#) [LST1-01G01-UV01-00](#) [LST1-01G01-PRD1-00](#) [XQEROY-00-0000-000000Q01-SB01](#) [LST1-01G01-UV03-00](#) [LST1-01G01-RYL1-00](#) [L135-A589003500000](#) [L135-L567L00000000](#) [L1C1-GRN1000000000](#) [LA G6SP-DAFA-24-1](#) [LS G6SP-CADB-1-1-Z](#) [LY H9PP-HZJZ-46-1](#) [SMTL6-RC](#) [MLEBLU-A1-0000-000U01](#) [MLEBLU-A1-0000-000U05](#) [MLEGRN-A1-0000-000101](#) [MLESRD-A1-0000-000W01](#) [XBDAMB-00-0000-000000701](#) [XBDAMB-00-0000-000000801](#) [XBDBLU-00-0000-000000201](#) [XBDBLU-00-0000-000000202](#) [XBDGRN-00-0000-000000B01](#) [XBDGRN-00-0000-000000C01](#) [XBDGRN-00-0000-000000C02](#) [XBDGRN-00-0000-000000D02](#)