

High Power White LEDs

SST-12-WxH



Table of Contents

Ordering Part Numbers	2
Binning Information	3
Chromaticity Binning Structure	4
Product Characteristics	7
Soldering Profile	10
Precautions for Use	11
Mechanical Dimensions	12
Tape and Reel	13
Packaging and Labeling	14

Features

- Round light emitter delivers superior beam quality and higher optical efficiency than square emitters for collimating optics
- High lumen density of monolithic emitter reduces the optics' size while maximizing the light intensity and beam distance
- Maximum Drive Current: 1.5 A
- Luminous Efficacy: typ. 113 lm/W @ 350 mA, 85°C (3000K)
- Color Temperature: 2700K, 3000K, 3500K, 4000K
- Color Rendering Index: >95
- Low thermal resistance: 4.9°C/W
- ANSI-compatible chromaticity bins
- Electrically isolated thermal path
- 8 kV HBM ESD rating per ANSI/ESDA/JEDEC JS-001
- RoHS and REACH compliant

Applications

- Directional Architectural Lighting, i.e.
 - Wall Washer
 - Track Light
 - Spot Light
- Miniature High-Output Recessed Lights
- Landscape Spot and Flood Lights
- Stage & Studio Lighting

Ordering Part Numbers

CCT	Minimum Flux Bin ¹	Minimum Flux (lm)	Chromaticity Bin Kit Code ²	Ordering Part Numbers
2700K	D3	93	271	SST-12-W27H-A120-D3271
			272	SST-12-W27H-A120-D3272
	D4	100	271	SST-12-W27H-A120-D4271
			272	SST-12-W27H-A120-D4272
3000K	D4	100	301	SST-12-W30H-A120-D4301
			302	SST-12-W30H-A120-D4302
	D5	107	301	SST-12-W30H-A120-D5301
			302	SST-12-W30H-A120-D5302
3500K	D5	107	351	SST-12-W35H-A120-D5351
			352	SST-12-W35H-A120-D5352
	E2	114	351	SST-12-W35H-A120-E2351
			352	SST-12-W35H-A120-E2352
4000K	E2	114	401	SST-12-W40H-A120-E2401
			402	SST-12-W40H-A120-E2402
	E3	122	401	SST-12-W40H-A120-E3401
			402	SST-12-W40H-A120-E3402

Notes

1. The Ordering Part Number specifies the Minimum Flux Bin in shipment; higher flux bins may be shipped without advance notice. Please refer to 'Luminous Flux Binning' table for details of all flux bins.
2. Shipments always adhere to the color bins specified in each Chromaticity Bin Kit. See 'Chromaticity Bin Kit Codes' table for the color bins included in each Bin Kit.

Part Number Nomenclature

SST — 12 — W<xy> — <p###> — <ffcc>

Product Family	Light Emission Area	Light Color	Package Configuration	Bin Kit
S: Surface Mount S: Dome Lensed T: Single Emitter	12: 1.2 mm ²	W: White <xx> Color Temperature 27: 2700K 40: 4000K <y> CRI Category Code H: CRI>95	<p> Solder Pad Configuration A: type A - see page 12 <###> Viewing angle 120: 120°	<ff> Minimum Flux Bin, see 'Luminous Flux Binning' table for details <ccc> Chromaticity Bin Kit, see 'Chromaticity Bin Kit Codes' table for details

Luminous Flux Binning

Flux Bin Code	Binning @ 350 mA, T _j =85°C ¹		@ 350 mA, T _j =25°C ¹	Correlated Minimum Flux (lm) @ T _j =85°C ²		
	Minimum Flux (lm)	Maximum Flux (lm)	Minimum Flux (lm)	700 mA	1000 mA	1500 mA
D3	93	100	104	167	223	301
D4	100	107	112	179	239	324
D5	107	114	120	192	256	347
E2	114	122	128	204	273	369
E3	122	130	137	219	292	395
E4	130	139	146	233	311	421
E5	139	148	156	249	333	450

Notes

- LEDs are measured at 25°C ambient temperature with 350 mA 20ms single pulse. The measured values are correlated to 350 mA at 85°C junction temperature (T_j). Luminus maintains a ±6% tolerance on flux measurement.
- Flux values at other junction temperature (T_j) and/or forward current conditions are calculated and for reference only.

Forward Voltage Binning

Voltage Bin Code	Binning @ 350 mA, T _j =85°C	
	Minimum Voltage (V)	Maximum Voltage (V)
VH	2.5	2.7
VJ	2.7	2.9

Note: Individual voltage bins are not orderable.

Chromaticity Binning Coordinates

CCT	Bin Code	CIE _x	CIE _y	Bin Code	CIE _x	CIE _y	Bin Code	CIE _x	CIE _y	Bin Code	CIE _x	CIE _y
2700K	JA1	0.4373	0.3893	JA2	0.4418	0.3981	JA3	0.4475	0.3994	JA4	0.4428	0.3906
		0.4418	0.3981		0.4465	0.4071		0.4523	0.4085		0.4475	0.3994
		0.4475	0.3994		0.4523	0.4085		0.4582	0.4099		0.4532	0.4008
		0.4428	0.3906		0.4475	0.3994		0.4532	0.4008		0.4483	0.3919
	JB1	0.4465	0.4071	JB2	0.4513	0.4164	JB3	0.4573	0.4178	JB4	0.4523	0.4085
		0.4513	0.4164		0.4562	0.426		0.4624	0.4274		0.4573	0.4178
		0.4573	0.4178		0.4624	0.4274		0.4687	0.4289		0.4634	0.4193
		0.4523	0.4085		0.4573	0.4178		0.4634	0.4193		0.4582	0.4099
	JC1	0.4582	0.4099	JC2	0.4634	0.4193	JC3	0.4695	0.4207	JC4	0.4641	0.4112
		0.4634	0.4193		0.4687	0.4289		0.475	0.4304		0.4695	0.4207
		0.4695	0.4207		0.475	0.4304		0.4813	0.4319		0.4756	0.4221
		0.4641	0.4112		0.4695	0.4207		0.4756	0.4221		0.47	0.4126
	JD1	0.4483	0.3919	JD2	0.4532	0.4008	JD3	0.4589	0.4021	JD4	0.4538	0.3931
		0.4532	0.4008		0.4582	0.4099		0.4641	0.4112		0.4589	0.4021
		0.4589	0.4021		0.4641	0.4112		0.47	0.4126		0.4646	0.4034
		0.4538	0.3931		0.4589	0.4021		0.4646	0.4034		0.4593	0.3944
3000K	HA1	0.4147	0.3814	HA2	0.4183	0.3898	HA3	0.4242	0.3919	HA4	0.4203	0.3833
		0.4183	0.3898		0.4221	0.3984		0.4281	0.4006		0.4242	0.3919
		0.4242	0.3919		0.4281	0.4006		0.4342	0.4028		0.43	0.3939
		0.4203	0.3833		0.4242	0.3919		0.43	0.3939		0.4259	0.3853
	HB1	0.4221	0.3984	HB2	0.4259	0.4073	HB3	0.4322	0.4096	HB4	0.4281	0.4006
		0.4259	0.4073		0.4299	0.4165		0.4364	0.4188		0.4322	0.4096
		0.4322	0.4096		0.4364	0.4188		0.443	0.4212		0.4385	0.4119
		0.4281	0.4006		0.4322	0.4096		0.4385	0.4119		0.4342	0.4028
	HC1	0.4342	0.4028	HC2	0.4385	0.4119	HC3	0.4449	0.4141	HC4	0.4403	0.4049
		0.4385	0.4119		0.443	0.4212		0.4496	0.4236		0.4449	0.4141
		0.4449	0.4141		0.4496	0.4236		0.4562	0.426		0.4513	0.4164
		0.4403	0.4049		0.4449	0.4141		0.4513	0.4164		0.4465	0.4071
	HD1	0.4259	0.3853	HD2	0.43	0.3939	HD3	0.4359	0.3960	HD4	0.4316	0.3873
		0.43	0.3939		0.4342	0.4028		0.4403	0.4049		0.4359	0.396
		0.4359	0.396		0.4403	0.4049		0.4465	0.4071		0.4418	0.3981
		0.4316	0.3873		0.4359	0.396		0.4418	0.3981		0.4373	0.3893

Chromaticity Binning Coordinates

CCT	Bin Code	CIE _x	CIE _y	Bin Code	CIE _x	CIE _y	Bin Code	CIE _x	CIE _y	Bin Code	CIE _x	CIE _y
3500K	GA1	0.3889	0.369	GA2	0.3915	0.3768	GA3	0.3981	0.38	GA4	0.3953	0.372
		0.3915	0.3768		0.3941	0.3848		0.401	0.3882		0.3981	0.38
		0.3981	0.38		0.401	0.3882		0.408	0.3916		0.4048	0.3832
		0.3953	0.372		0.3981	0.38		0.4048	0.3832		0.4017	0.3751
	GB1	0.3941	0.3848	GB2	0.3968	0.393	GB3	0.4040	0.3966	GB4	0.401	0.3882
		0.3968	0.393		0.3996	0.4015		0.4071	0.4052		0.404	0.3966
		0.404	0.3966		0.4071	0.4052		0.4146	0.4089		0.4113	0.4001
		0.401	0.3882		0.404	0.3966		0.4113	0.4001		0.408	0.3916
	GC1	0.408	0.3916	GC2	0.4113	0.4001	GC3	0.4186	0.4037	GC4	0.415	0.395
		0.4113	0.4001		0.4146	0.4089		0.4222	0.4127		0.4186	0.4037
		0.4186	0.4037		0.4222	0.4127		0.4299	0.4165		0.4259	0.4073
		0.415	0.395		0.4186	0.4037		0.4259	0.4073		0.4221	0.3984
	GD1	0.4017	0.3751	GD2	0.4048	0.3832	GD3	0.4116	0.3865	GD4	0.4082	0.3782
		0.4048	0.3832		0.408	0.3916		0.415	0.395		0.4116	0.3865
		0.4116	0.3865		0.415	0.395		0.4221	0.3984		0.4183	0.3898
		0.4082	0.3782		0.4116	0.3865		0.4183	0.3898		0.4147	0.3814
4000K	FA1	0.367	0.3578	FA2	0.3686	0.3649	FA3	0.3744	0.3685	FA4	0.3726	0.3612
		0.3686	0.3649		0.3702	0.3722		0.3763	0.376		0.3744	0.3685
		0.3744	0.3685		0.3763	0.376		0.3825	0.3798		0.3804	0.3721
		0.3726	0.3612		0.3744	0.3685		0.3804	0.3721		0.3783	0.3646
	FB1	0.3702	0.3722	FB2	0.3719	0.3797	FB3	0.3782	0.3837	FB4	0.3763	0.376
		0.3719	0.3797		0.3736	0.3874		0.3802	0.3916		0.3782	0.3837
		0.3782	0.3837		0.3802	0.3916		0.3869	0.3958		0.3847	0.3877
		0.3763	0.376		0.3782	0.3837		0.3847	0.3877		0.3825	0.3798
	FC1	0.3825	0.3798	FC2	0.3847	0.3877	FC3	0.3912	0.3917	FC4	0.3887	0.3836
		0.3847	0.3877		0.3869	0.3958		0.3937	0.4001		0.3912	0.3917
		0.3912	0.3917		0.3937	0.4001		0.4006	0.4044		0.3978	0.3958
		0.3887	0.3836		0.3912	0.3917		0.3978	0.3958		0.395	0.3875
	FD1	0.3783	0.3646	FD2	0.3804	0.3721	FD3	0.3863	0.3758	FD4	0.384	0.3681
		0.3804	0.3721		0.3825	0.3798		0.3887	0.3836		0.3863	0.3758
		0.3863	0.3758		0.3887	0.3836		0.395	0.3875		0.3924	0.3794
		0.384	0.3681		0.3863	0.3758		0.3924	0.3794		0.3898	0.3716

Chromaticity Binning Diagram

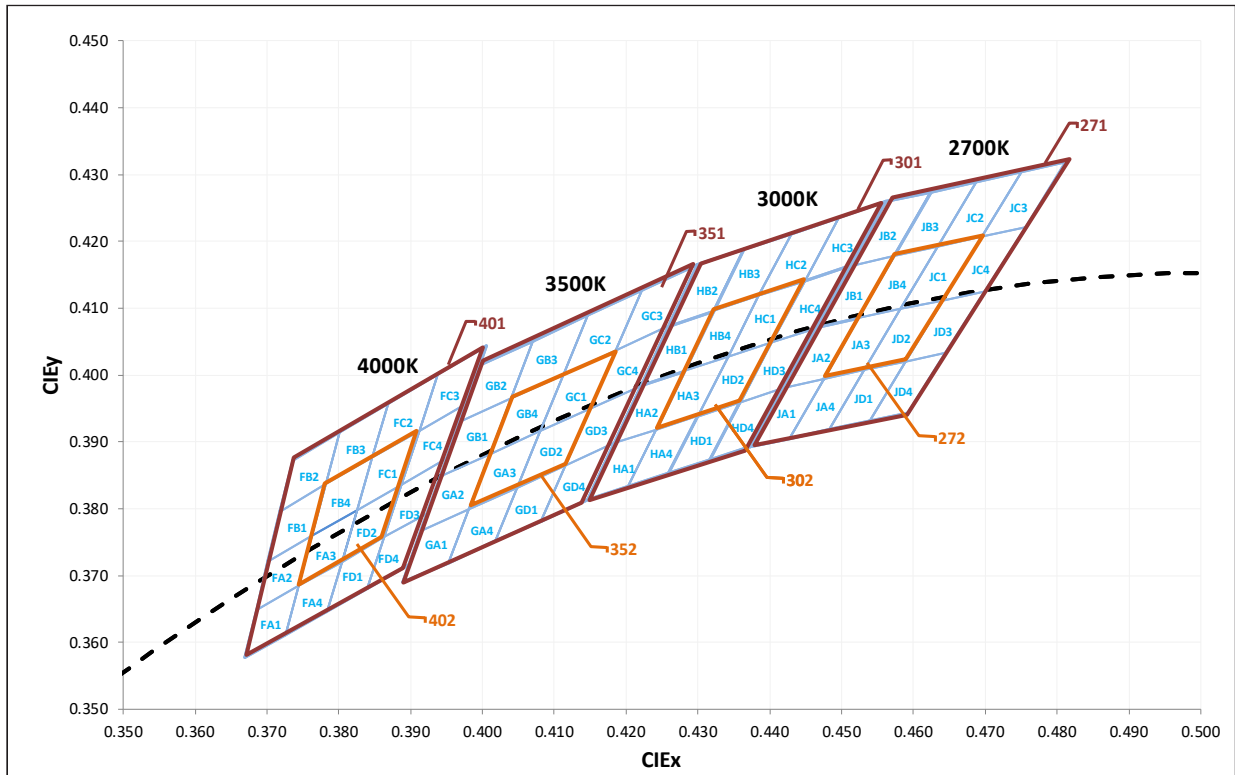

Chromaticity Bin Kit Codes

CCT	Bin Kit	Chromaticity Bins
2700K	271	JA1, JA2, JA3, JA4, JB1, JB2, JB3, JB4, JC1, JC2, JC3, JC4, JD1, JD2, JD3, JD4
	272	JA3, JB4, JC1, JD2
3000K	301	HA1, HA2, HA3, HA4, HB1, HB2, HB3, HB4, HC1, HC2, HC3, HC4, HD1, HD2, HD3, HD4
	302	HA3, HB4, HC1, HD2
3500K	351	GA1, GA2, GA3, GA4, GB1, GB2, GB3, GB4, GC1, GC2, GC3, GC4, GD1, GD2, GD3, GD4
	352	GA3, GB4, GC1, GD2
4000K	401	FA1, FA2, FA3, FA4, FB1, FB2, FB3, FB4, FC1, FC2, FC3, FC4, FD1, FD2, FD3, FD4
	402	FA3, FB4, FC1, FD2

Note: Luminus maintains a tolerance of ± 0.005 on chromaticity (CIE_x, CIE_y), and ± 2 on Color Rendering Index (CRI) measurements.

Product Characteristics

Parameter	Symbol	Minimum	Typical	Maximum	Unit
Viewing Angle (FWHM)	$2\theta_{1/2}$		120		Degree
Color Rendering Index ¹ ($T_j=85^\circ\text{C}$)	CRI	95			
Color Rendering, R9 ($T_j=85^\circ\text{C}$)	R9	50			
Thermal resistance (Electrical) Junction/Solder Point	$R_{thjs-EL}$		4.9		$^\circ\text{C}/\text{W}$
Junction Temperature	T_j			150	$^\circ\text{C}$
Forward Voltage (@ $I_f=350\text{ mA}$, $T_j=85^\circ\text{C}$)	V_f	2.5	2.7	2.9	V
DC Forward Current	I_f	0.1		1.5	A
Surge Current ($t < 10\text{ ms}$, Duty Cycle $< 10\%$)	I_{s-max}			2.5	A
Reverse Voltage ($I_r=10\text{ mA}$)	V_r			5	V
Power Dissipation	P_d			4.9	W
Operating Temperature	T_{opr}	-40		100	$^\circ\text{C}$
Storage Temperature	T_{stg}	-40		100	$^\circ\text{C}$
ESD withstand Voltage HBM Per ANSI/ESDA/JEDEC JS-001	V_{HBM}	8			kV
ESD withstand Voltage CDM Per ANSI/ESDA/JEDEC JS-002	V_{CDM}	1			kV

Notes

1. Luminus maintains a tolerance of ± 2 on Color Rendering Index (CRI) measurement.

Optical & Electrical Characteristics

Relative Luminous Flux vs. Forward Current

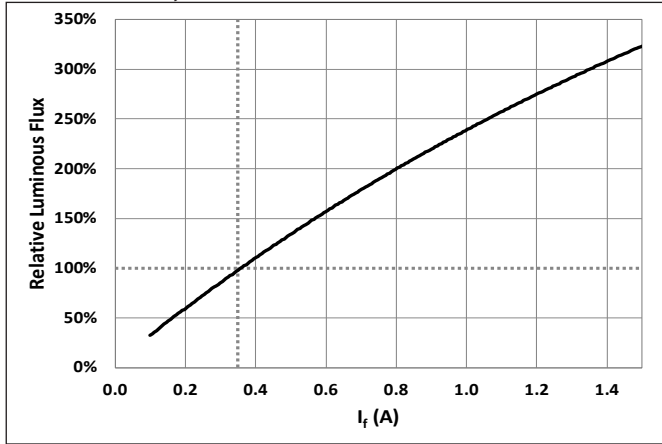
 $\Phi_v/\Phi_v(0.35\text{ A}), T_j = 85^\circ\text{C}$

Relative Luminous Flux vs. Temperature(T_j)

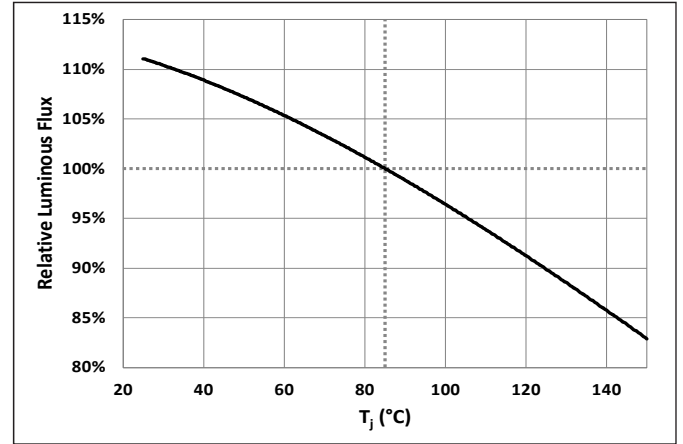
 $\Phi_v/\Phi_v(85^\circ\text{C}), I_f=0.35\text{ A}$

Forward Voltage vs. Forward Current

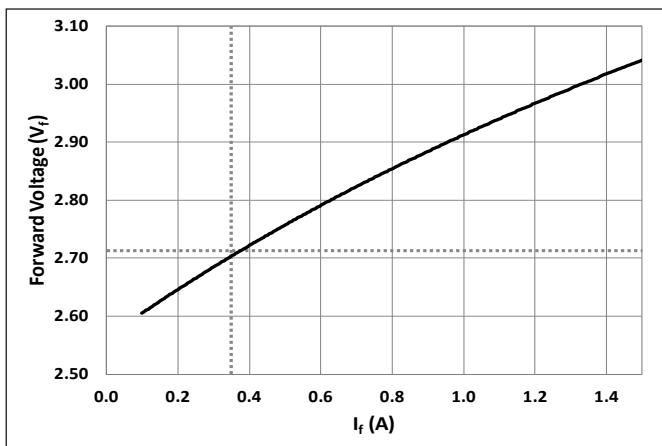
 $V_f=f(I_f), T_j=85^\circ\text{C}$

Relative Forward Voltage vs. Temperature(T_j)

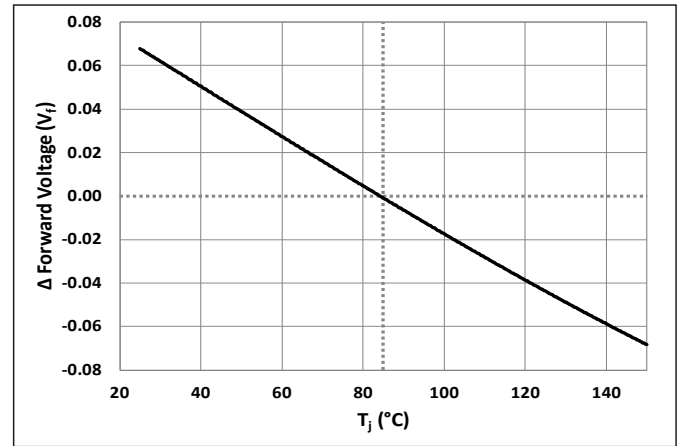
 $\Delta V_f=V_f(T_j)-V_f(85^\circ\text{C}), I_f=0.35\text{ A}$

Relative Chromaticity vs. Forward Current

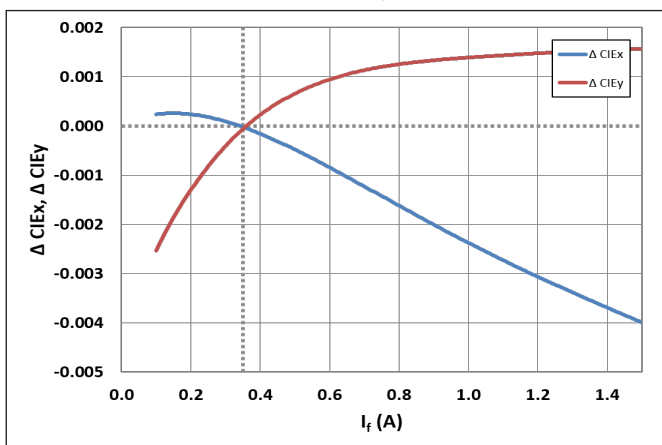
 $\Delta CIE_{x,y}=CIE_{x,y}(I_f)-CIE_{x,y}(0.35\text{ A}), T_j=85^\circ\text{C}$

Relative Chromaticity vs. Temperature(T_j)

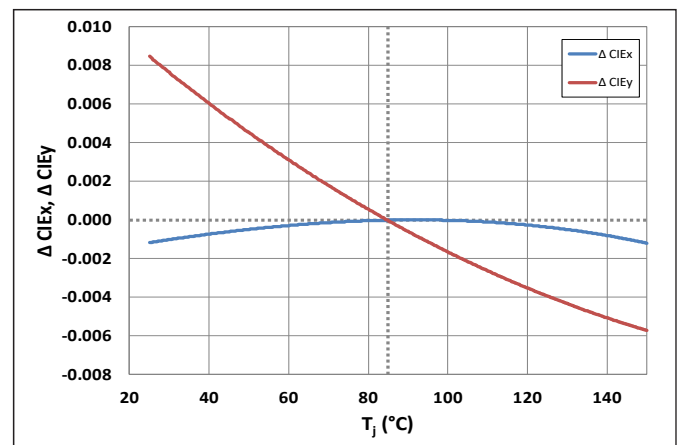
 $\Delta CIE_{x,y}=CIE_{x,y}(T_j)-CIE_{x,y}(85^\circ\text{C}), I_f=0.35\text{ A}$

Relative Spectral Power Distribution

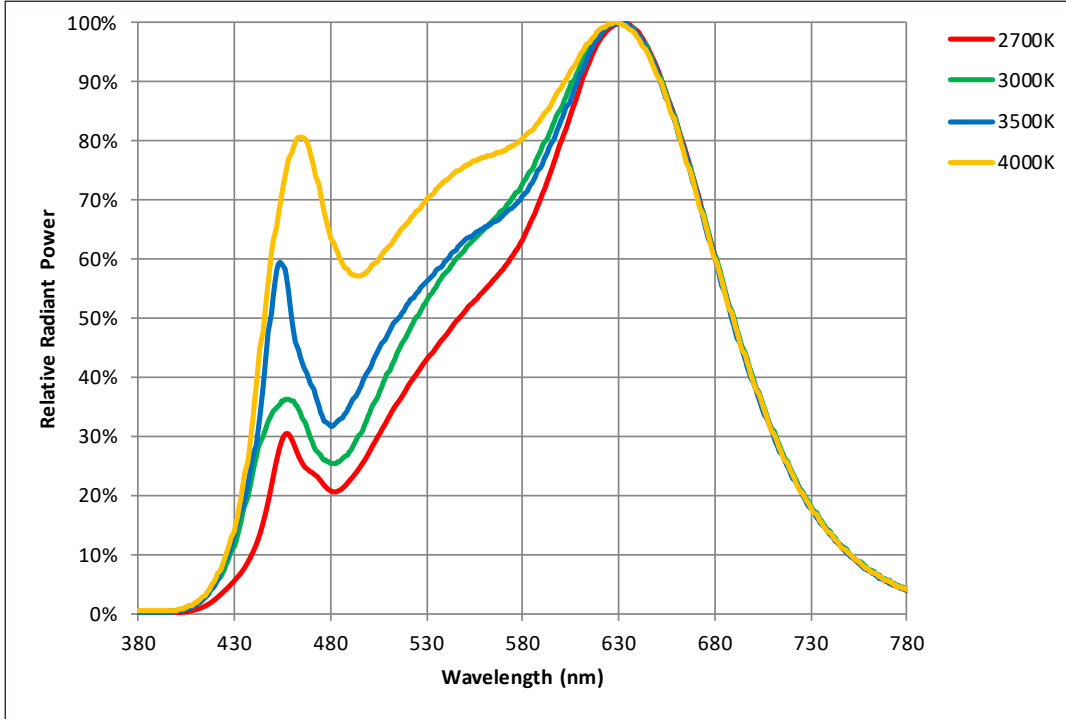
 $I_f=0.35\text{ A}, T_j=85^\circ\text{C}$

Typical Radiation Characteristics

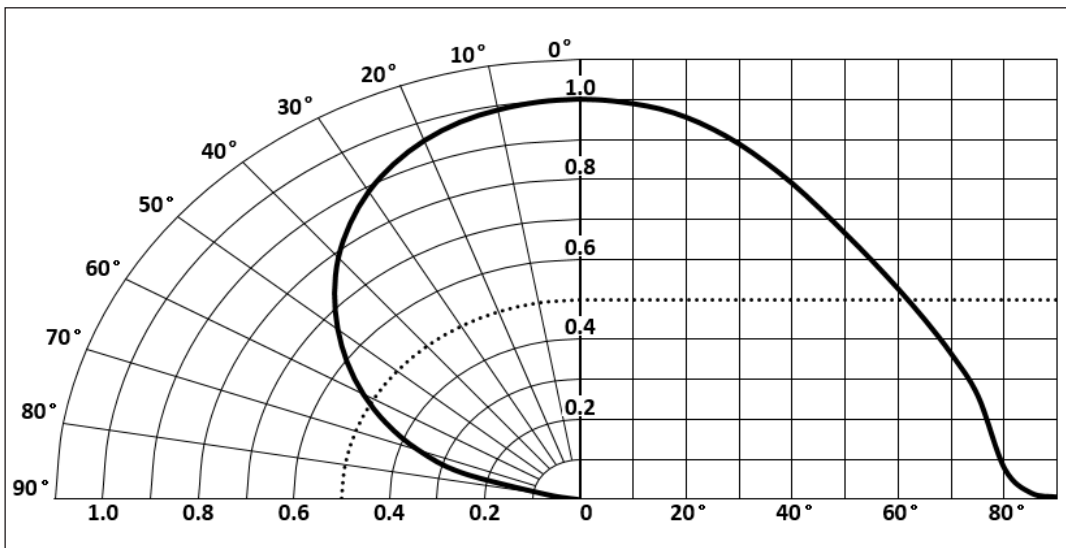
 $I_f=0.35\text{ A}, T_j=25^\circ\text{C}$

Soldering Profile

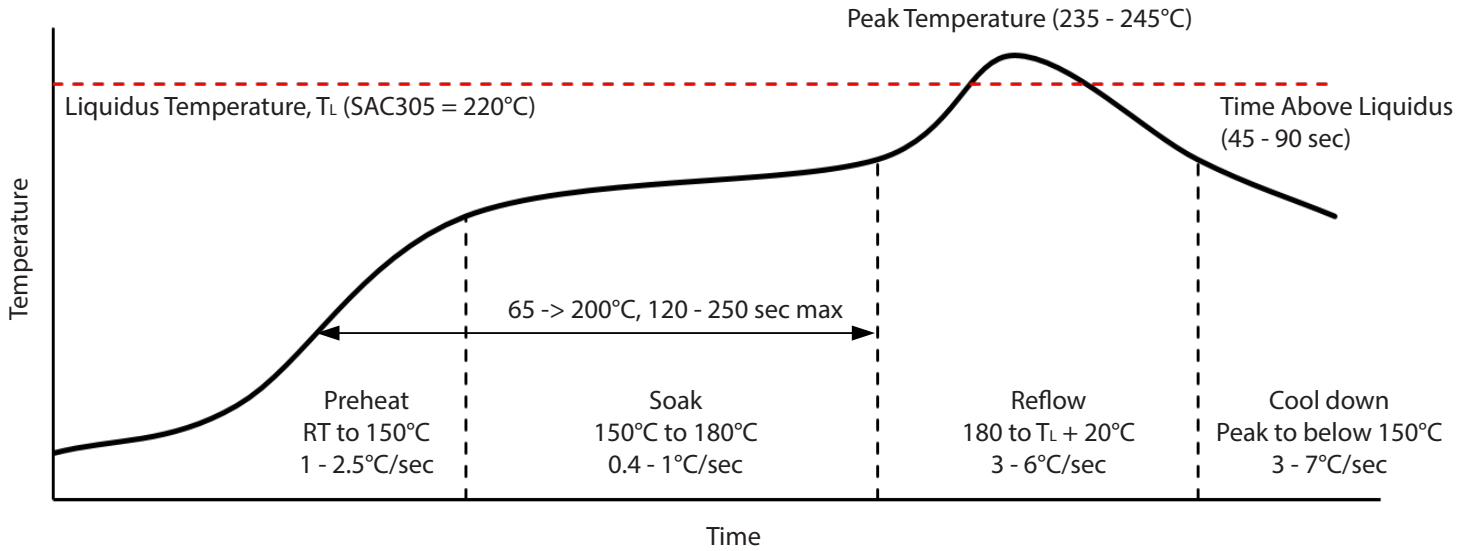

SMT Rework Guideline	Manual Hotplate Reflow	Hot Air Gun Reflow
Heating Time	< 60 sec	
Hotplate Temperature	< 245°C	< 150°C

Notes

- Product complies to Moisture Sensitivity Level 3 (MSL 3).
- The numbers in the table are specific to SAC305. Luminus recommends using an SAC305 solder paste with a no-clean flux for RoHS compliant products.
- During the pick and place process, axial forces on the dome (or window) should not exceed 0.5 Newtons (N).
- Use of a multi-zone IR reflow oven with a nitrogen blanket is recommended.
- Time-temperature profile of the reflow process showing the four functional profile zones are defined in IPC-7801. Temperature is referenced to the center of the PCB.
- Luminus recommends to use the solder paste data sheet information as a starting point in time-temperature process development.
- These are general guidelines. Consult the solder paste manufacturer's datasheet for guidelines specific to the alloy and flux combination used in your application. For more information, please refer to: <https://luminusdevices.zendesk.com/hc/en-us/articles/360060306692-How-do-I-Reflow-Solder-Luminus-SMD-Components->
- For any technical questions about soldering process, please contact Luminus at techsupport@luminus.com.

Precautions for Use

Storage:

1. Before opening the package

The LEDs should be kept at a temperature lower than 40°C and relative humidity lower than 90%. The LEDs should be used within a year. When storing the LEDs, moisture proof package with absorbent material (silica gel) is recommended.

2. After opening the package

The LEDs should be kept at a temperature lower than 30°C and relative humidity lower than 60%. The LEDs should be soldered within 168 hours (7 days) after opening the moisture proof package.

If unused LEDs remain, they should be stored in moisture proof packages, such as sealed containers with moisture absorbent material (silica gel). It is also recommended to return the unused LEDs to the original moisture proof package and to seal it again.

If the moisture absorbent material (silica gel) vaporizes or passes the expiration date, baking treatment should be performed by using the following conditions : 60°C for 20 hours.

The LED's electrode and lead frame comprise a silver plated copper alloy. The silver surface may be affected by environments. Please avoid conditions which may cause the LEDs to corrode or discolor. The corrosion or discoloration might lower solderability or affect optical characteristics.

Please avoid rapid transition in ambient temperature, especially in high humidity environments where condensation can occur.

Static Electricity:

1. The products are sensitive to static electricity, and care should be taken when handling them.

2. Static electricity or surge voltage will damage the LEDs. It is recommended to wear anti-electrostatic gloves or wristband when handling the LEDs.

3. All devices, equipment and machinery must be properly grounded. It is recommended that measures be taken against surge voltage to the equipment that mounts the LEDs.

Tape and Reel

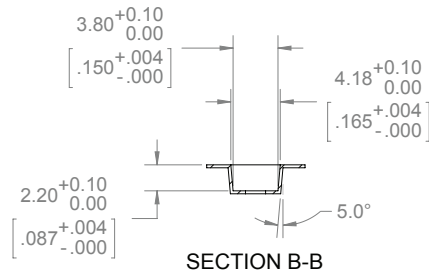
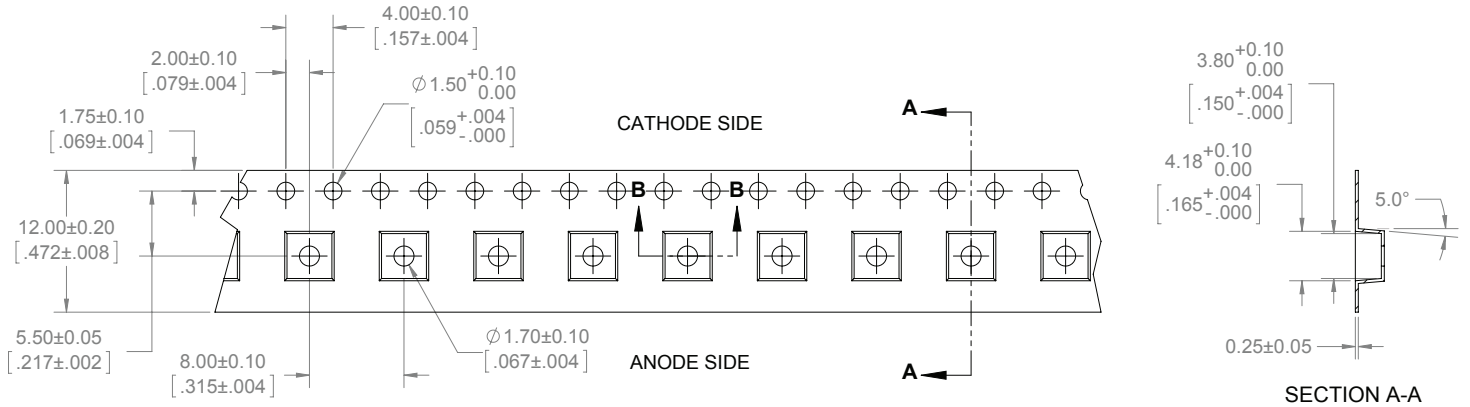

Notes:

1. Final tape and reel packaging must meet the requirements of JEDEC-STD-033, LEVEL 2A.
2. Leave 304.8 mm [12.00 in] of type empty for lead in (38 empty pockets)
3. Leave 457.2 mm [18.00 in] of type empty for trailer (57 empty pockets)
4. Must comply to EIA-481-C-2003
5. Each reel contains 1,000 units

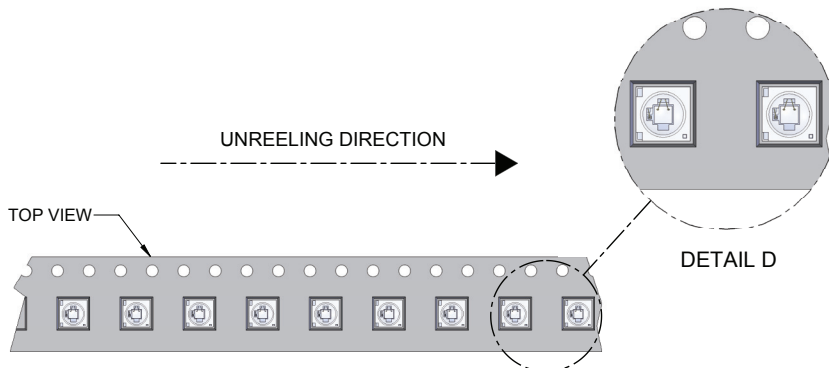
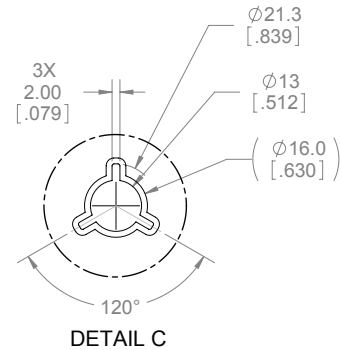
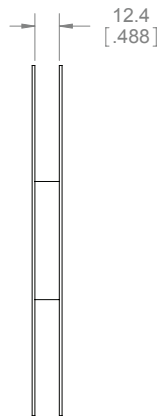
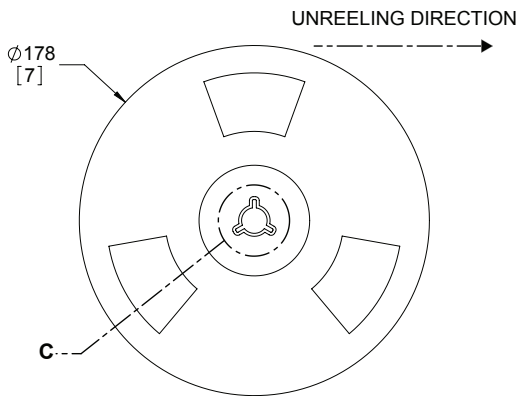

Packaging and Labeling

Packaged Reel

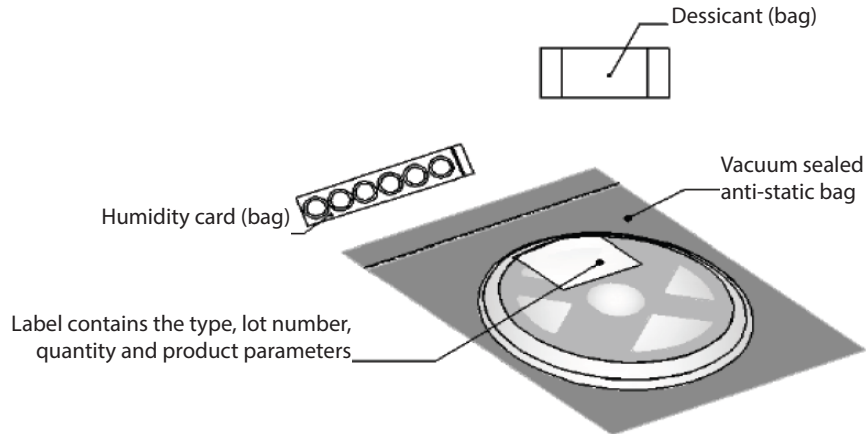

Label on Reel

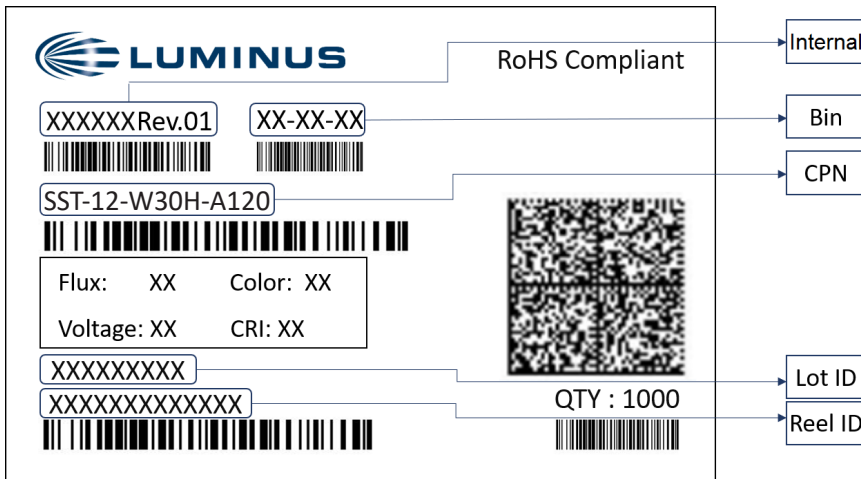

Label Information	
CPN	Luminus ordering part number
MPN	For Luminus internal use
QTY	Quantity of parts per reel
Flux	Single flux bin code (see <i>Luminous Flux Binning</i> table on page 3)
Voltage	Single voltage bin code (see <i>Forward Voltage Binning</i> table on page 3)
Color	Single chromaticity bin code (see <i>Chromaticity Bin Coordinates</i> table on page 4 & 5)
CRI	N/A
Lot ID & Reel ID	For Luminus internal use

Packaging Boxes

Box Size 1 - 5 reels per box
 Size: 22.5 x 24.5 x 6.5 cm

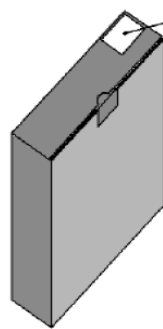
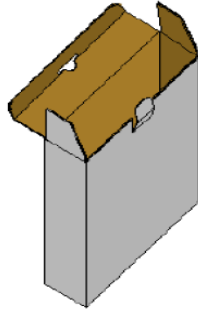

Label contains the type, lot number, quantity and product parameters

Box Size 2 - 10 reels per box
 Size: 22.5 x 24.5 x 13 cm

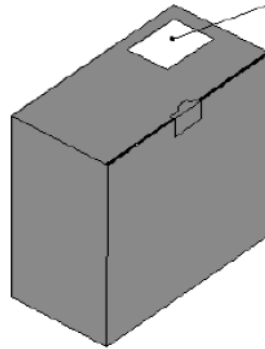
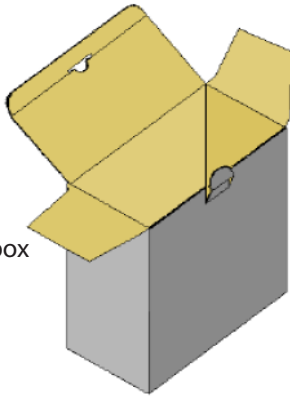

Label contains the type, lot number, quantity and product parameters

Shipping Label on Packaging Box

Multiple labels are attached to the box (one label per reel inside the box)

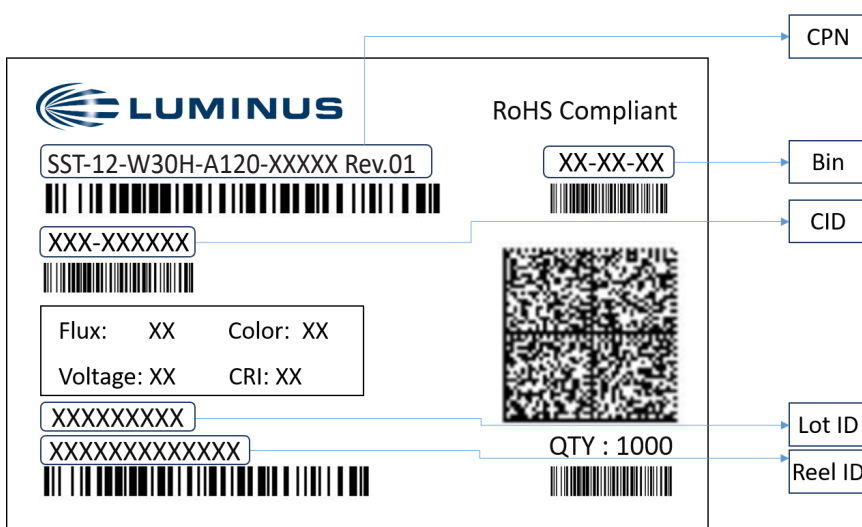

Label Information	
CPN	Luminus ordering part number
CID	Customer ID
QTY	Quantity of parts per reel
Flux	Single flux bin code (see <i>Luminus Flux Binning</i> table on page 3)
Voltage	Single voltage bin code (see <i>Forward Voltage Binning</i> table on page 3)
Color	Single chromaticity bin code (see <i>Chromaticity Bin Coordinates</i> table on page 4 & 5)
CRI	N/A
Lot ID & Reel ID	For Luminus internal use

X-ON Electronics

Largest Supplier of Electrical and Electronic Components

Click to view similar products for [High Power LEDs - White category:](#)

Click to view products by [Luminus Devices manufacturer:](#)

Other Similar products are found below :

[LTW-K140SZR40](#) [LTPL-P00DWS57](#) [LTW-K140SZR30](#) [LZP-D0WW00-0000](#) [JK2835AWT-00-0000-000B0HL227E-BLK](#) [LTW-K140SZR57](#) [LTW-K140SZR27](#) [BXRC-35E10K0-D-73](#) [MP-5050-6100-65-80](#) [KW CSLPM2.CC-8L8M-4L8N](#) [KW CSLPM2.CC-8L8M-4O9Q](#) [KW DPLS32.SB-6H6J-E5P7-EG-Z264](#) [L1V1-507003V500000](#) [BXRE-27E1000-C-83](#) [BXRE-27G0800-D-83](#) [BXRE-27G2000-B-83](#) [BXRE-50C2001-C-84](#) [BXRH-35S1001-B-73](#) [BXRH-30E0300-B-83](#) [BXRH-30E1000-G-83](#) [115780](#) [LM1311D4W-12B4C12\(Ra4\)-DS](#) [ELJU\(9\)-K40M3-0LTHE-R4000](#) [ELJU\(9\)-K40M3-0LTHE-R3000](#) [LM1311D4W-12B2C24\(Ra4\)-DS](#) [KW2 CFLNM2.TK-D2D9-4L07M0-SC6B](#) [XEGAWT-H2-0000-000-00000UT122G](#) [XHP35B-H0-0000-0D0ZA230G](#) [XHP35B-H0-0000-0D0ZA440G](#) [XHP35B-H0-0000-0D0ZA227G](#) [XHP35B-H0-0000-0D0ZA235G](#) [CTM-9-4018-90-36-TWD6-F3-3](#) [CVM-32-56-95-54-AC00-F2-2](#) [SST-12-W65S-A120-H4652](#) [CXM-4-24-90-18-AC40-F5-2](#) [CXM-4-22-90-18-AC40-F5-2](#) [LM002H384W-7B3C12\(Ra5\)\(ANSI-2700K\)](#) [LM002H384W-9B4C12\(Ra2\)\(ANSI-2700K\)](#) [LM002H384W-7B3C12\(Ra7\)\(ANSI-2700K\)](#) [LM002H384W-9B4C12\(Ra2\)\(ANSI-3000K\)](#) [LM002H384W-9B4C12\(Ra4\)-S\(ANSI-3500K\)](#) [LM002H384W-9B4C12\(Ra5\)\(ANSI-4000K\)](#) [LM002H384W-7B3C12\(Ra2\)-S\(ANSI-3000K\)](#) [LM002H384W-7B3C12\(Ra5\)\(ANSI-4000K\)](#) [LM002H384W-7B3C12\(Ra7\)\(ANSI-4000K\)](#) [HL-LM002H384W-5B2C5\(Ra4\)\(ANSI-3000K\)](#) [HL-LM002H384W-7B1C18\(Ra4\)\(ANSI-6000K\)](#) [LM002H384W-7B3C12\(Ra5\)\(ANSI-3500K\)](#) [HL-LM002H384W-5B2C5\(Ra4\)\(ANSI-4000K\)](#) [HL-LM002H384W-5B2C5\(Ra4\)\(ANSI-6000K\)](#)