

# High Power White LEDs

## SST-20-WxH

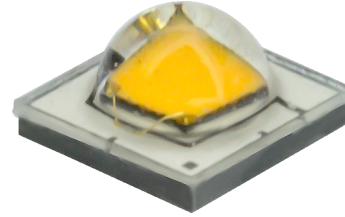

### Table of Contents

Ordering Part Numbers. . . . .2

Binning Information. . . . .3

Chromaticity Binning  
Structure . . . . .4

Product Characteristics. . . . .7

Soldering Profile . . . . . 10

Precautions for Use. . . . . 11

Mechanical Dimensions . . 12

Tape and Reel . . . . . 14

Packaging and Labeling . . 15

### Features

- High CRI, high-efficacy warm white LEDs designed for high-performance directional lighting applications.
- High lumen density of monolithic emitter, up to 503 lm/mm<sup>2</sup> (3000K), ideal for minimizing the fixture size while maximizing the optical efficiency in beam quality critical architectural lighting applications.
- Maximum Drive Current: 2 A
- Luminous Efficacy: typ. 130 lm/W @ 350 mA, 85°C (3000K)
- Color Temperature: 2700K, 3000K, 3500K, 4000K
- Color Rendering Index: > 95
- Low thermal resistance: 1.6 °C/W
- ANSI-compatible chromaticity bins
- LM-80 10,000-hr test data available, excellent TM-21 lifetime and color stability
- Available in 2 soldering footprint configurations
- Electrically isolated thermal path
- 8 kV HBM ESD rating per ANSI/ESDA/JEDEC JS-001
- RoHS and REACH compliant

### Applications

- Directional Light Fixtures, i.e.
  - Wall Washer
  - Track Light
  - Spot Light
- Miniature High-Output Recessed Lights
- Landscape Spot and Flood Lights
- Stage & Studio Lighting

**Ordering Part Numbers**

CCT	Minimum Flux Bin <sup>1</sup>	Minimum Flux (lm)	Chromaticity Bin Kit Code <sup>2</sup>	Solder Pad Type <sup>3</sup>	Ordering Part Numbers
2700K	J3	100	271	A	SST-20-W27H-A120-J3271
				B	SST-20-W27H-B120-J3271
			272	A	SST-20-W27H-A120-J3272
				B	SST-20-W27H-B120-J3272
	J4	107	271	A	SST-20-W27H-A120-J4271
				B	SST-20-W27H-B120-J4271
			272	A	SST-20-W27H-A120-J4272
				B	SST-20-W27H-B120-J4272
3000K	J4	107	301	A	SST-20-W30H-A120-J4301
				B	SST-20-W30H-B120-J4301
			302	A	SST-20-W30H-A120-J4302
				B	SST-20-W30H-B120-J4302
	J5	114	301	A	SST-20-W30H-A120-J5301
				B	SST-20-W30H-B120-J5301
			302	A	SST-20-W30H-A120-J5302
				B	SST-20-W30H-B120-J5302
3500K	J5	114	351	A	SST-20-W35H-A120-J5351
				B	SST-20-W35H-B120-J5351
			352	A	SST-20-W35H-A120-J5352
				B	SST-20-W35H-B120-J5352
	K2	122	351	A	SST-20-W35H-A120-K2351
				B	SST-20-W35H-B120-K2351
			352	A	SST-20-W35H-A120-K2352
				B	SST-20-W35H-B120-K2352
4000K	K2	122	401	A	SST-20-W40H-A120-K2401
				B	SST-20-W40H-B120-K2401
			402	A	SST-20-W40H-A120-K2402
				B	SST-20-W40H-B120-K2402
	K3	130	401	A	SST-20-W40H-A120-K3401
				B	SST-20-W40H-B120-K3401
			402	A	SST-20-W40H-A120-K3402
				B	SST-20-W40H-B120-K3402

**Notes**

1. The Ordering Part Number specifies the Minimum Flux Bin in shipment; higher flux bins may be shipped without advance notice. Please refer to 'Luminous Flux Binning' table for details of all flux bins.
2. Shipments always adhere to the color bins specified in each Chromaticity Bin Kit. See 'Chromaticity Bin Kit Codes' table for the color bins included in each Bin Kit.
3. See 'Mechanical Dimensions' for A and B types' solder pad configurations. All product mechanical, electrical and optical specifications are otherwise identical.

## Part Number Nomenclature

SST — 20 — W<xx> — <p###> — <ffcc>

Product Family	Light Emission Area	Light Color	Package Configuration	Bin Kit
<b>S:</b> Surface Mount <b>S:</b> Dome Lensed <b>T:</b> Single Emitter	<b>20:</b> 2.0 mm <sup>2</sup>	<b>W:</b> White <b>&lt;xx&gt;</b> Color Temperature <b>27:</b> 2700K <b>40:</b> 4000K <b>&lt;y&gt;</b> CRI Category Code <b>H:</b> CRI>95	<b>&lt;p&gt;</b> Solder Pad Configuration <b>A:</b> type A - see page 12 <b>B:</b> type B - see page 13  <b>&lt;###&gt;</b> Viewing angle <b>120:</b> 120°	<b>&lt;ff&gt;</b> Minimum Flux Bin, see 'Luminus Flux Binning' table for details <b>&lt;ccc&gt;</b> Chromaticity Bin Kit, see 'Chromaticity Bin Kit Codes' table for details

## Luminous Flux Binning

Flux Bin Code	Binning @ 350 mA, T <sub>j</sub> =85°C <sup>1</sup>		@ 350 mA, T <sub>j</sub> =25°C <sup>1</sup>	Correlated Minimum Flux (lm) @ T <sub>j</sub> =85°C <sup>2</sup>			
	Minimum Flux (lm)	Maximum Flux (lm)	Minimum Flux (lm)	700 mA	1000 mA	1500 mA	2000 mA
J2	93	100	104	171	232	320	396
J3	100	107	112	184	249	344	426
J4	107	114	120	197	267	368	456
J5	114	122	128	210	284	392	486
K2	122	130	137	224	304	420	520
K3	130	139	146	239	324	447	554
K4	139	148	156	256	346	478	592

### Notes

- LEDs are measured at 25°C ambient temperature with 350 mA 20ms single pulse. The measured values are correlated to 350mA at 85°C junction temperature (T<sub>j</sub>). Luminus maintains a ±6% tolerance on flux measurement.
- Flux values at other junction temperature (T<sub>j</sub>) and/or forward current conditions are calculated and for reference only.

## Forward Voltage Binning

Voltage Bin Code	Binning @ 350mA, T <sub>j</sub> =85°C	
	Minimum Voltage (V)	Maximum Voltage (V)
VH	2.5	2.7
VJ	2.7	2.9
VK	2.9	3.1

Note: Individual voltage bins are not orderable.

**Chromaticity Binning Coordinates**

CCT	Bin Code	CIE <sub>x</sub>	CIE <sub>y</sub>	Bin Code	CIE <sub>x</sub>	CIE <sub>y</sub>	Bin Code	CIE <sub>x</sub>	CIE <sub>y</sub>	Bin Code	CIE <sub>x</sub>	CIE <sub>y</sub>
2700K	JA1	0.4373	0.3893	JA2	0.4418	0.3981	JA3	0.4475	0.3994	JA4	0.4428	0.3906
		0.4418	0.3981		0.4465	0.4071		0.4523	0.4085		0.4475	0.3994
		0.4475	0.3994		0.4523	0.4085		0.4582	0.4099		0.4532	0.4008
		0.4428	0.3906		0.4475	0.3994		0.4532	0.4008		0.4483	0.3919
	JB1	0.4465	0.4071	JB2	0.4513	0.4164	JB3	0.4573	0.4178	JB4	0.4523	0.4085
		0.4513	0.4164		0.4562	0.426		0.4624	0.4274		0.4573	0.4178
		0.4573	0.4178		0.4624	0.4274		0.4687	0.4289		0.4634	0.4193
		0.4523	0.4085		0.4573	0.4178		0.4634	0.4193		0.4582	0.4099
	JC1	0.4582	0.4099	JC2	0.4634	0.4193	JC3	0.4695	0.4207	JC4	0.4641	0.4112
		0.4634	0.4193		0.4687	0.4289		0.475	0.4304		0.4695	0.4207
		0.4695	0.4207		0.475	0.4304		0.4813	0.4319		0.4756	0.4221
		0.4641	0.4112		0.4695	0.4207		0.4756	0.4221		0.47	0.4126
	JD1	0.4483	0.3919	JD2	0.4532	0.4008	JD3	0.4589	0.4021	JD4	0.4538	0.3931
		0.4532	0.4008		0.4582	0.4099		0.4641	0.4112		0.4589	0.4021
		0.4589	0.4021		0.4641	0.4112		0.47	0.4126		0.4646	0.4034
		0.4538	0.3931		0.4589	0.4021		0.4646	0.4034		0.4593	0.3944
3000K	HA1	0.4147	0.3814	HA2	0.4183	0.3898	HA3	0.4242	0.3919	HA4	0.4203	0.3833
		0.4183	0.3898		0.4221	0.3984		0.4281	0.4006		0.4242	0.3919
		0.4242	0.3919		0.4281	0.4006		0.4342	0.4028		0.43	0.3939
		0.4203	0.3833		0.4242	0.3919		0.43	0.3939		0.4259	0.3853
	HB1	0.4221	0.3984	HB2	0.4259	0.4073	HB3	0.4322	0.4096	HB4	0.4281	0.4006
		0.4259	0.4073		0.4299	0.4165		0.4364	0.4188		0.4322	0.4096
		0.4322	0.4096		0.4364	0.4188		0.443	0.4212		0.4385	0.4119
		0.4281	0.4006		0.4322	0.4096		0.4385	0.4119		0.4342	0.4028
	HC1	0.4342	0.4028	HC2	0.4385	0.4119	HC3	0.4449	0.4141	HC4	0.4403	0.4049
		0.4385	0.4119		0.443	0.4212		0.4496	0.4236		0.4449	0.4141
		0.4449	0.4141		0.4496	0.4236		0.4562	0.426		0.4513	0.4164
		0.4403	0.4049		0.4449	0.4141		0.4513	0.4164		0.4465	0.4071
	HD1	0.4259	0.3853	HD2	0.43	0.3939	HD3	0.4359	0.3960	HD4	0.4316	0.3873
		0.43	0.3939		0.4342	0.4028		0.4403	0.4049		0.4359	0.396
		0.4359	0.396		0.4403	0.4049		0.4465	0.4071		0.4418	0.3981
		0.4316	0.3873		0.4359	0.396		0.4418	0.3981		0.4373	0.3893

**Chromaticity Binning Coordinates**

CCT	Bin Code	CIE <sub>x</sub>	CIE <sub>y</sub>	Bin Code	CIE <sub>x</sub>	CIE <sub>y</sub>	Bin Code	CIE <sub>x</sub>	CIE <sub>y</sub>	Bin Code	CIE <sub>x</sub>	CIE <sub>y</sub>
3500K	GA1	0.3889	0.369	GA2	0.3915	0.3768	GA3	0.3981	0.38	GA4	0.3953	0.372
		0.3915	0.3768		0.3941	0.3848		0.401	0.3882		0.3981	0.38
		0.3981	0.38		0.401	0.3882		0.408	0.3916		0.4048	0.3832
		0.3953	0.372		0.3981	0.38		0.4048	0.3832		0.4017	0.3751
	GB1	0.3941	0.3848	GB2	0.3968	0.393	GB3	0.4040	0.3966	GB4	0.401	0.3882
		0.3968	0.393		0.3996	0.4015		0.4071	0.4052		0.404	0.3966
		0.404	0.3966		0.4071	0.4052		0.4146	0.4089		0.4113	0.4001
		0.401	0.3882		0.404	0.3966		0.4113	0.4001		0.408	0.3916
	GC1	0.408	0.3916	GC2	0.4113	0.4001	GC3	0.4186	0.4037	GC4	0.415	0.395
		0.4113	0.4001		0.4146	0.4089		0.4222	0.4127		0.4186	0.4037
		0.4186	0.4037		0.4222	0.4127		0.4299	0.4165		0.4259	0.4073
		0.415	0.395		0.4186	0.4037		0.4259	0.4073		0.4221	0.3984
	GD1	0.4017	0.3751	GD2	0.4048	0.3832	GD3	0.4116	0.3865	GD4	0.4082	0.3782
		0.4048	0.3832		0.408	0.3916		0.415	0.395		0.4116	0.3865
		0.4116	0.3865		0.415	0.395		0.4221	0.3984		0.4183	0.3898
		0.4082	0.3782		0.4116	0.3865		0.4183	0.3898		0.4147	0.3814
4000K	FA1	0.367	0.3578	FA2	0.3686	0.3649	FA3	0.3744	0.3685	FA4	0.3726	0.3612
		0.3686	0.3649		0.3702	0.3722		0.3763	0.376		0.3744	0.3685
		0.3744	0.3685		0.3763	0.376		0.3825	0.3798		0.3804	0.3721
		0.3726	0.3612		0.3744	0.3685		0.3804	0.3721		0.3783	0.3646
	FB1	0.3702	0.3722	FB2	0.3719	0.3797	FB3	0.3782	0.3837	FB4	0.3763	0.376
		0.3719	0.3797		0.3736	0.3874		0.3802	0.3916		0.3782	0.3837
		0.3782	0.3837		0.3802	0.3916		0.3869	0.3958		0.3847	0.3877
		0.3763	0.376		0.3782	0.3837		0.3847	0.3877		0.3825	0.3798
	FC1	0.3825	0.3798	FC2	0.3847	0.3877	FC3	0.3912	0.3917	FC4	0.3887	0.3836
		0.3847	0.3877		0.3869	0.3958		0.3937	0.4001		0.3912	0.3917
		0.3912	0.3917		0.3937	0.4001		0.4006	0.4044		0.3978	0.3958
		0.3887	0.3836		0.3912	0.3917		0.3978	0.3958		0.395	0.3875
	FD1	0.3783	0.3646	FD2	0.3804	0.3721	FD3	0.3863	0.3758	FD4	0.384	0.3681
		0.3804	0.3721		0.3825	0.3798		0.3887	0.3836		0.3863	0.3758
		0.3863	0.3758		0.3887	0.3836		0.395	0.3875		0.3924	0.3794
		0.384	0.3681		0.3863	0.3758		0.3924	0.3794		0.3898	0.3716

## Chromaticity Binning Diagram

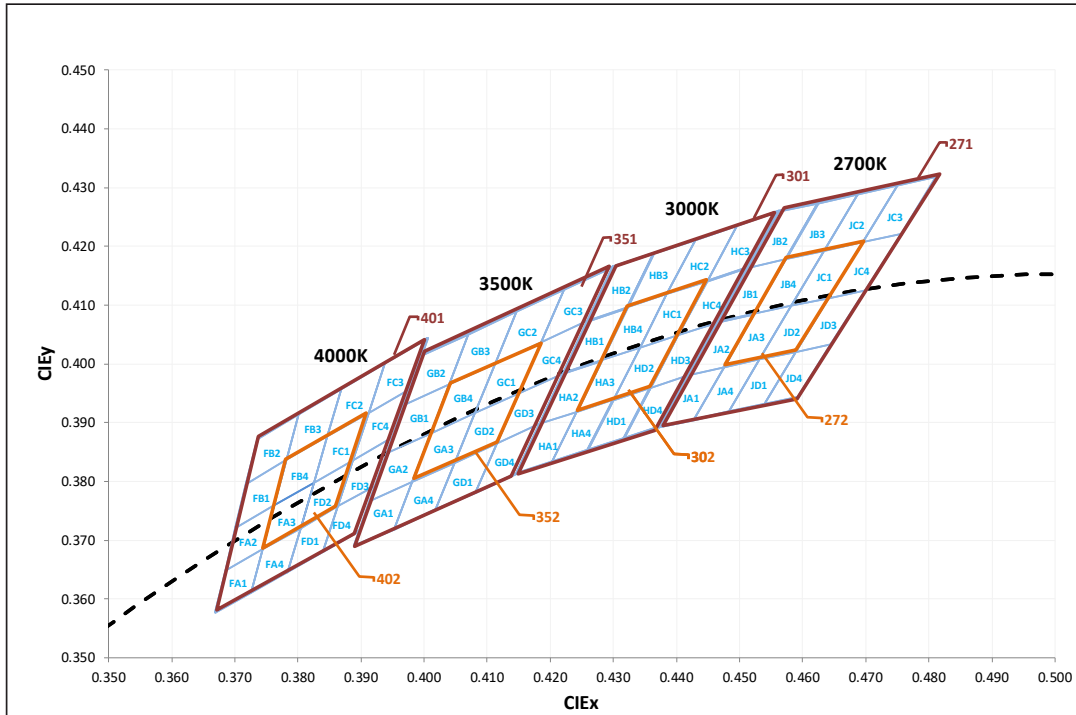

## Chromaticity Bin Kit Codes

CCT	Bin Kit	Chromaticity Bins
2700K	271	JA1, JA2, JA3, JA4, JB1, JB2, JB3, JB4, JC1, JC2, JC3, JC4, JD1, JD2, JD3, JD4
	272	JA3, JB4, JC1, JD2
3000K	301	HA1, HA2, HA3, HA4, HB1, HB2, HB3, HB4, HC1, HC2, HC3, HC4, HD1, HD2, HD3, HD4
	302	HA3, HB4, HC1, HD2
3500K	351	GA1, GA2, GA3, GA4, GB1, GB2, GB3, GB4, GC1, GC2, GC3, GC4, GD1, GD2, GD3, GD4
	352	GA3, GB4, GC1, GD2
4000K	401	FA1, FA2, FA3, FA4, FB1, FB2, FB3, FB4, FC1, FC2, FC3, FC4, FD1, FD2, FD3, FD4
	402	FA3, FB4, FC1, FD2

### Notes

- LED chromaticity is measured and binned at 25°C ambient temperature with 350 mA 20 ms single pulse.
- Luminus maintains a tolerance of  $\pm 0.005$  on chromaticity (CIE<sub>x</sub>, CIE<sub>y</sub>), and  $\pm 2$  on Color Rendering Index (CRI) measurements.

## Product Characteristics

Parameter	Symbol	Minimum	Typical	Maximum	Unit
Viewing Angle (FWHM)	$2\theta_{1/2}$		120		Degree
Color Rendering Index <sup>1</sup> ( $T_j=85^\circ\text{C}$ )	CRI	95			
Color Rendering, R9 ( $T_j=85^\circ\text{C}$ )	R9	50			
Thermal resistance (Electrical) Junction/Solder Point	$R_{thjs-EL}$		1.6		$^\circ\text{C/W}$
Junction Temperature	$T_j$			115	$^\circ\text{C}$
Forward Voltage ( $I_f=350\text{ mA}$ , $T_j=85^\circ\text{C}$ )	$V_f$	2.5	2.71	3.1	V
DC Forward Current	$I_f$	0.2		2	A
Surge Current ( $t < 10\text{ ms}$ , Duty Cycle $< 10\%$ )	$I_{s-max}$			3	A
Reverse Voltage ( $I_r=10\text{ mA}$ )	$V_r$			5	V
Power Dissipation	$P_d$			7	W
Operating Temperature	$T_{opr}$	-40		100	$^\circ\text{C}$
Storage Temperature	$T_{stg}$	-40		100	$^\circ\text{C}$
ESD withstand Voltage HBM Per ANSI/ESDA/JEDEC JS-001	$V_{HBM}$	8			kV
ESD withstand Voltage CDM Per ANSI/ESDA/JEDEC JS-002	$V_{CDM}$	1			kV

### Note

1. Luminus maintains a tolerance of  $\pm 2$  on Color Rendering Index (CRI) measurement.

## Optical & Electrical Characteristics

### Relative Luminous Flux vs. Forward Current

$\Phi_v/\Phi_v(0.35\text{ A}), T_j = 85^\circ\text{C}$

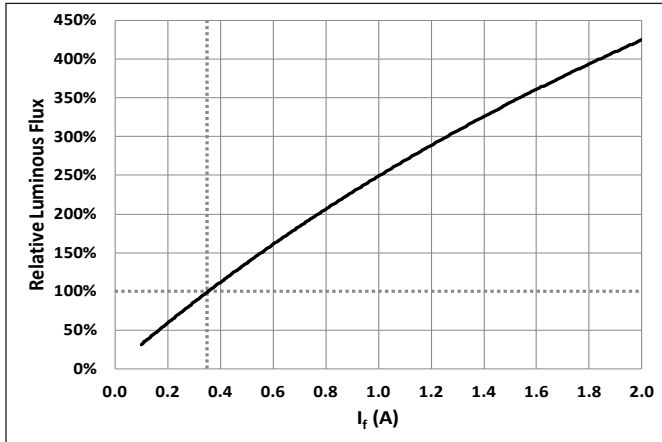

### Forward Voltage vs. Forward Current

$V_f=f(I_f), T_j=85^\circ\text{C}$

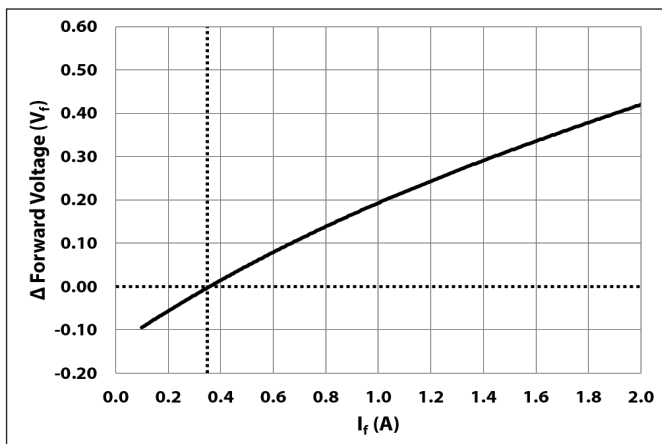

### Relative Chromaticity vs. Forward Current

$\Delta\text{CIEx}, \Delta\text{CIEy} = \text{CIEx}, \text{y}(I_f) - \text{CIEx}, \text{y}(0.35\text{ A}), T_j = 85^\circ\text{C}$

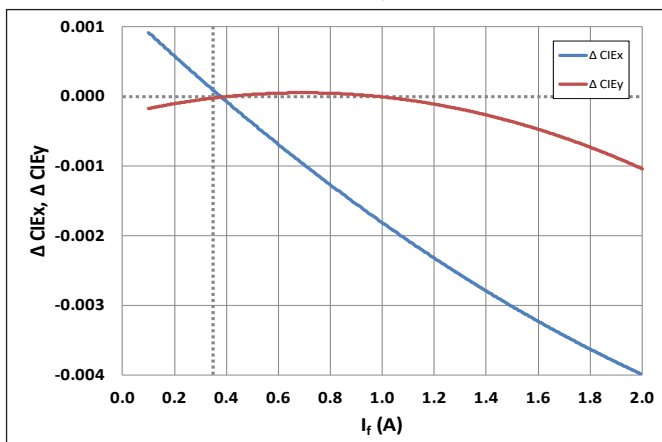

### Relative Luminous Flux vs. Temperature( $T_j$ )

$\Phi_v/\Phi_v(85^\circ\text{C}), I_f=0.35\text{ A}$

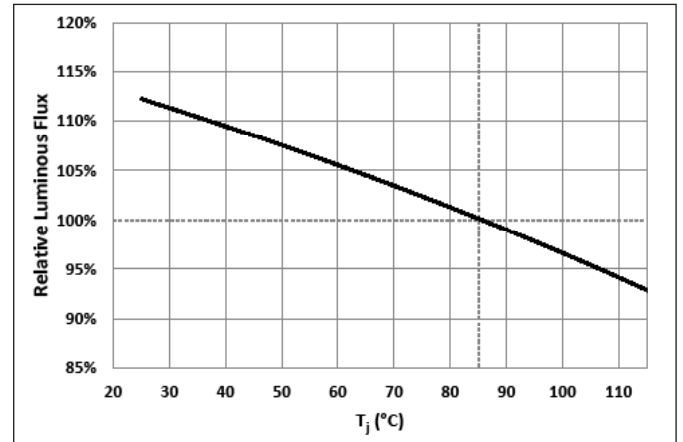

### Relative Forward Voltage vs. Temperature( $T_j$ )

$\Delta V_f = V_f(T_j) - V_f(85^\circ\text{C}), I_f = 0.35\text{ A}$

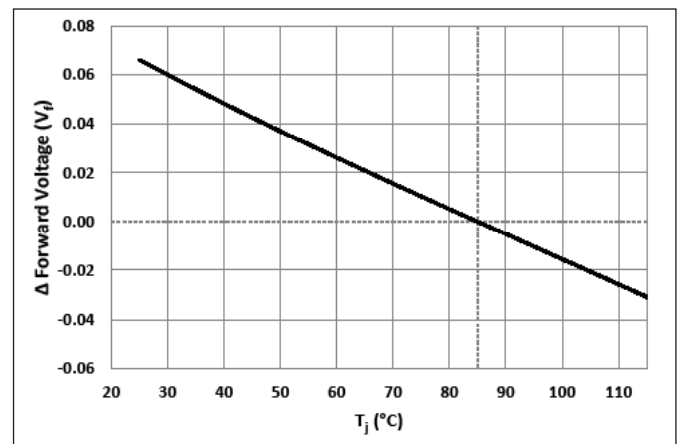

### Relative Chromaticity vs. Temperature( $T_j$ )

$\Delta\text{CIEx}, \Delta\text{CIEy} = \text{CIEx}, \text{y}(T_j) - \text{CIEx}, \text{y}(25^\circ\text{C}), I_f = 0.35\text{ A}$

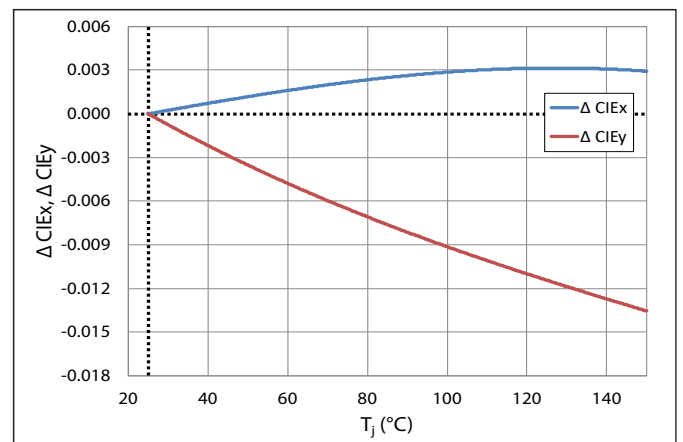



### Relative Spectral Power Distribution

$I_f=0.35\text{ A}, T_j=85^\circ\text{C}$

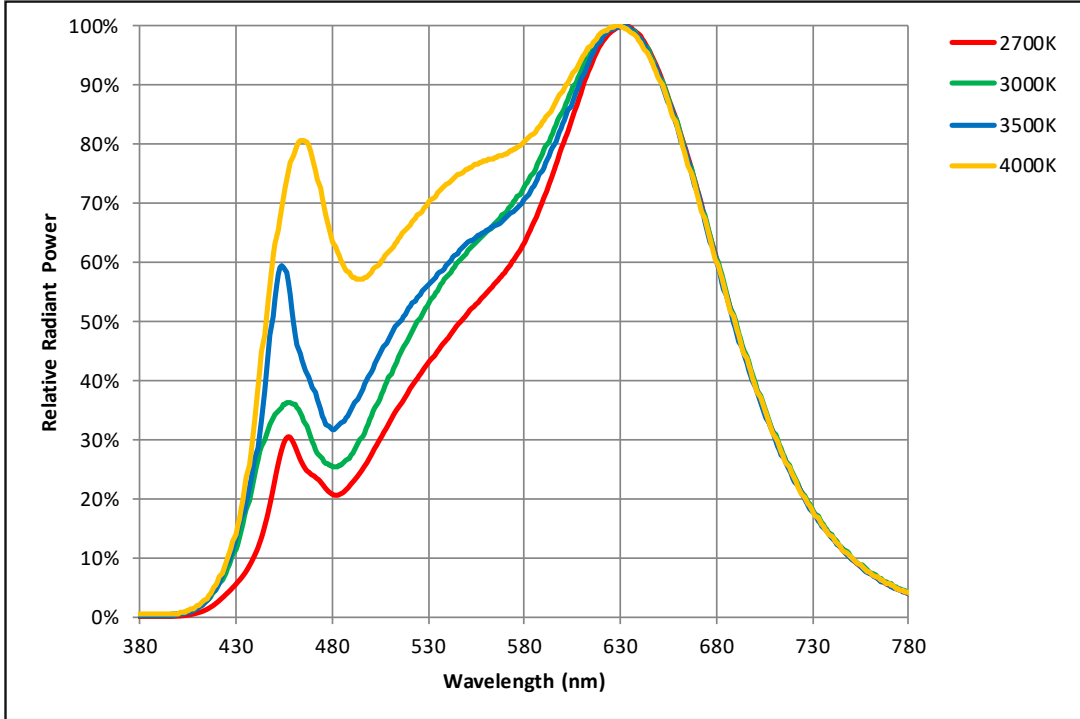

### Typical Radiation Characteristics (A120 and B120 Types)

$I_f=0.35\text{ A}, T_j=25^\circ\text{C}$

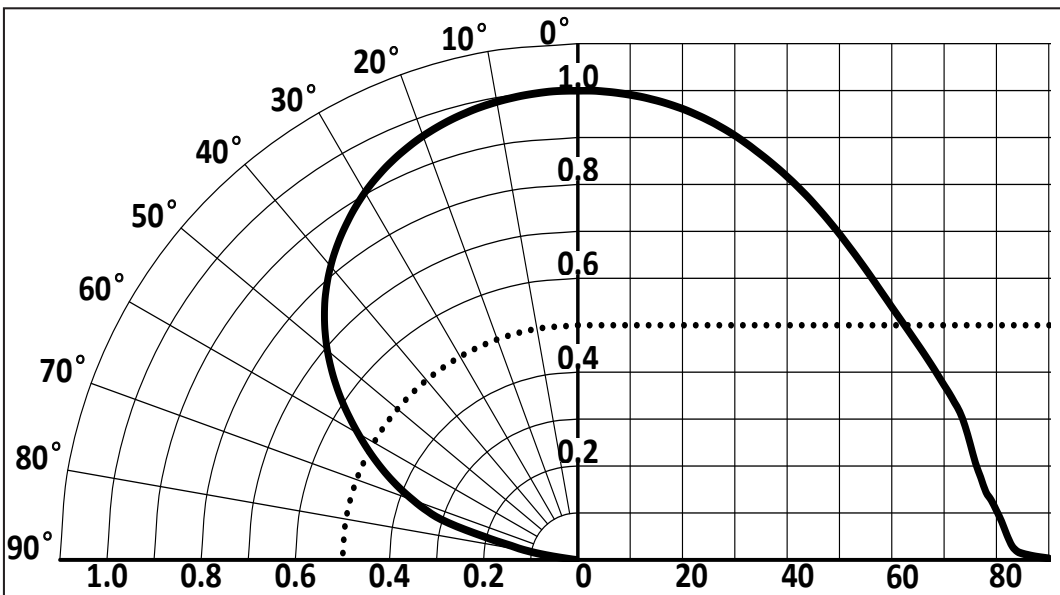

## Soldering Profile

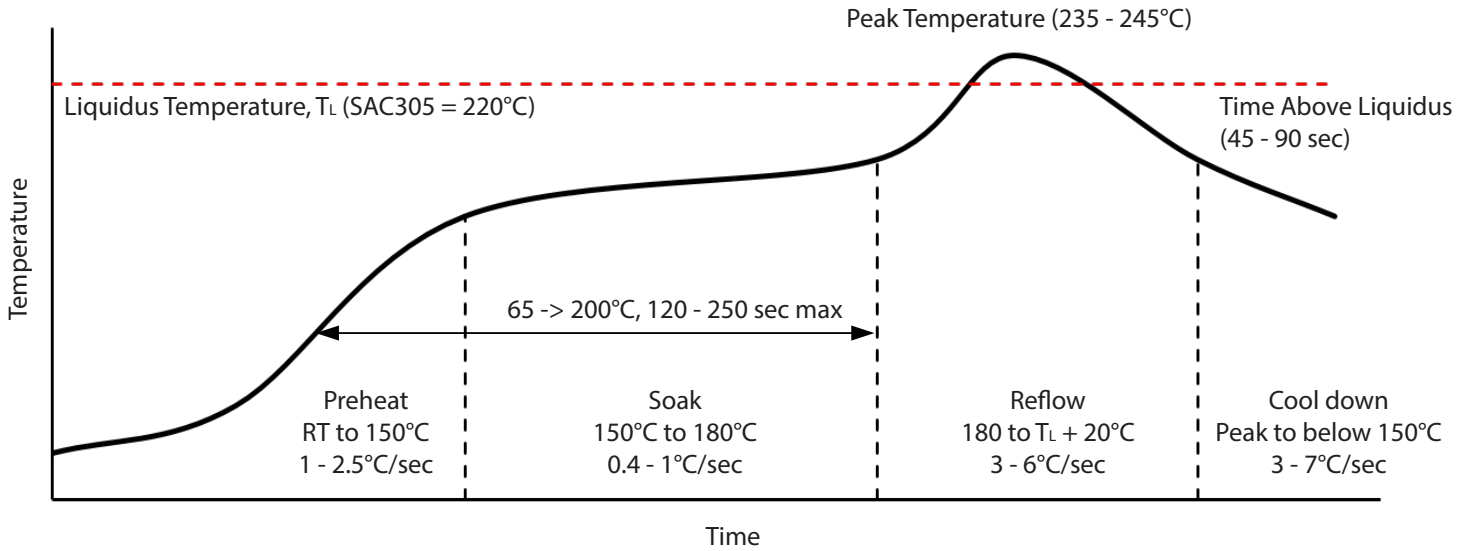

SMT Rework Guideline	Manual Hotplate Reflow	Hot Air Gun Reflow
Heating Time	< 60 sec	
Hotplate Temperature	< 245°C	< 150°C

### Notes

- Product complies to Moisture Sensitivity Level 3 (MSL 3).
- The numbers in the table are specific to SAC305. Luminus recommends using an SAC305 solder paste with a no-clean flux for RoHS compliant products.
- During the pick and place process, axial forces on the dome (or window) should not exceed 0.5 Newtons (N).
- Use of a multi-zone IR reflow oven with a nitrogen blanket is recommended.
- Time-temperature profile of the reflow process showing the four functional profile zones are defined in IPC-7801. Temperature is referenced to the center of the PCB.
- Luminus recommends to use the solder paste data sheet information as a starting point in time-temperature process development.
- These are general guidelines. Consult the solder paste manufacturer's datasheet for guidelines specific to the alloy and flux combination used in your application. For more information, please refer to: <https://luminusdevices.zendesk.com/hc/en-us/articles/360060306692-How-do-I-Reflow-Solder-Luminus-SMD-Components->
- For any technical questions about soldering process, please contact Luminus at techsupport@luminus.com.

## Precautions for Use

### Storage:

#### 1. Before opening the package

The LEDs should be kept at a temperature lower than 40°C and relative humidity lower than 90%. The LEDs should be used within a year. When storing the LEDs, moisture proof package with absorbent material (silica gel) is recommended.

#### 2. After opening the package

The LEDs should be kept at a temperature lower than 30°C and relative humidity lower than 60%. The LEDs should be soldered within 168 hours (7 days) after opening the moisture proof package.

If unused LEDs remain, they should be stored in moisture proof packages, such as sealed containers with moisture absorbent material (silica gel). It is also recommended to return the unused LEDs to the original moisture proof package and to seal it again.

If the moisture absorbent material (silica gel) vaporizes or passes the expiration date, baking treatment should be performed by using the following conditions : 60°C for 20 hours.

The LED's electrode and lead frame comprise a silver plated copper alloy. The silver surface may be affected by environments. Please avoid conditions which may cause the LEDs to corrode or discolor. The corrosion or discoloration might lower solderability or affect optical characteristics.

Please avoid rapid transition in ambient temperature, especially in high humidity environments where condensation can occur.

### Static Electricity:

1. The products are sensitive to static electricity, and care should be taken when handling them.

2. Static electricity or surge voltage will damage the LEDs. It is recommended to wear anti-electrostatic gloves or wristband when handling the LEDs.

3. All devices, equipment and machinery must be properly grounded. It is recommended that measures be taken against surge voltage to the equipment that mounts the LEDs.

## A120 Package Configuration

### Mechanical Dimensions

All dimensions are in millimeter  $\pm 0.13$  mm

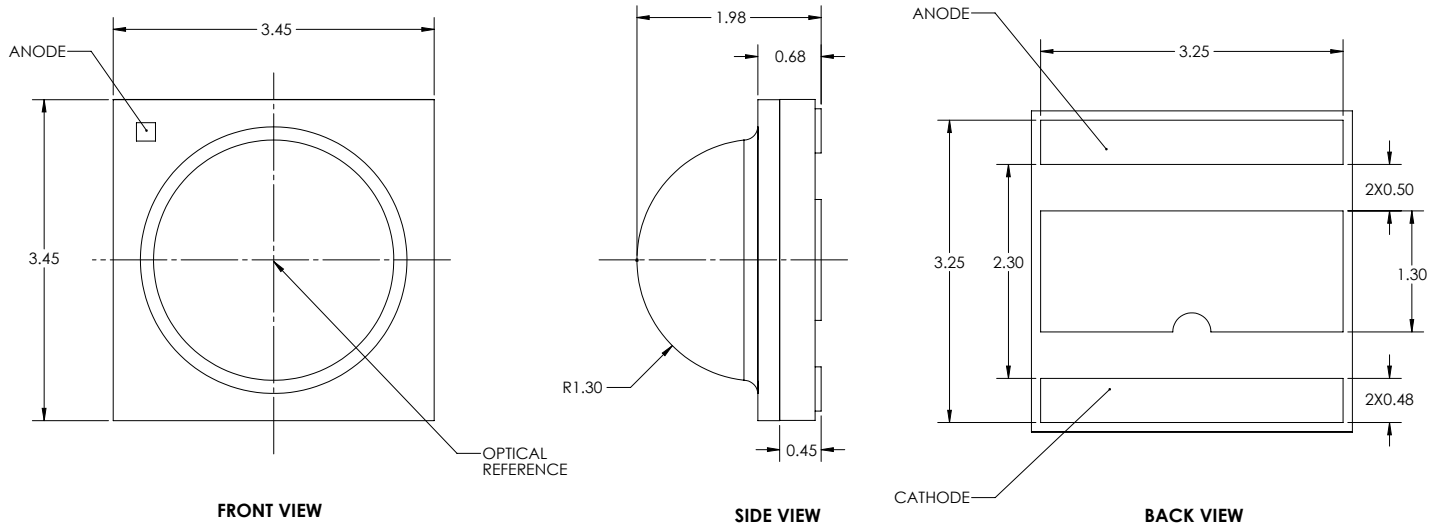

### Recommended PCB Solder Pad and Stencil Pattern

All dimensions are in millimeter  $\pm 0.13$  mm

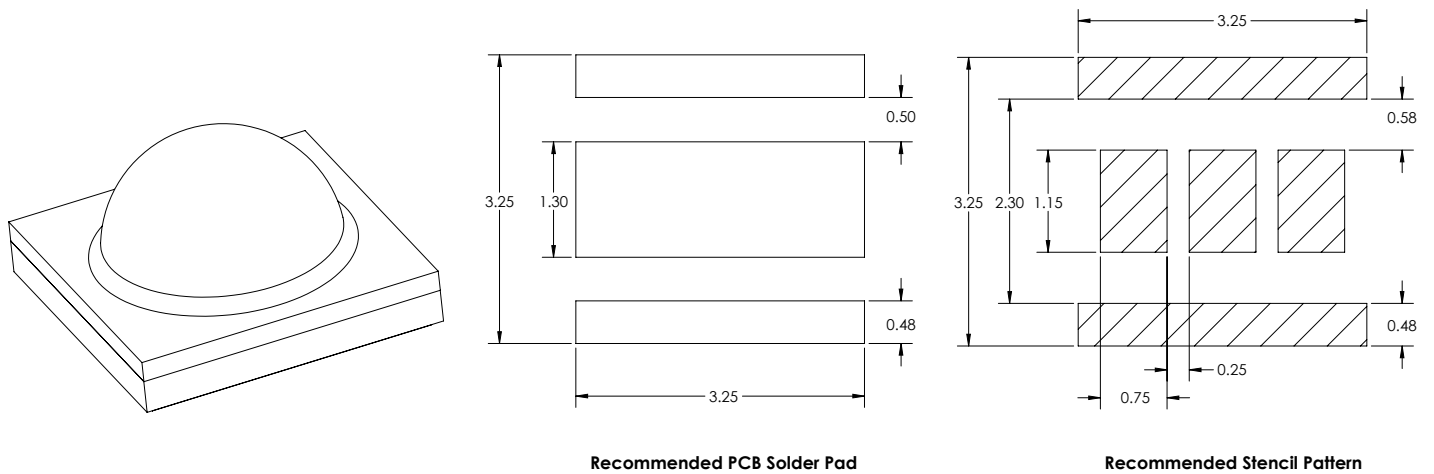

## B120 Package Configuration

### Mechanical Dimensions

All dimensions are in millimeter  $\pm 0.13$  mm

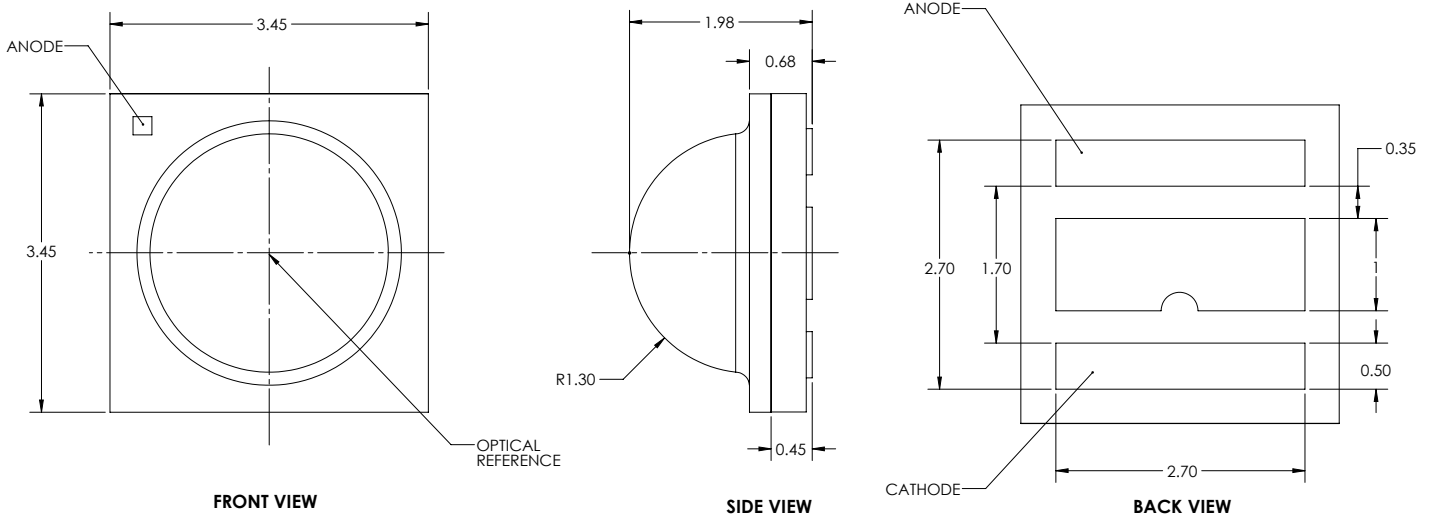

### Recommended PCB Solder Pad and Stencil Pattern

All dimensions are in millimeter  $\pm 0.13$  mm

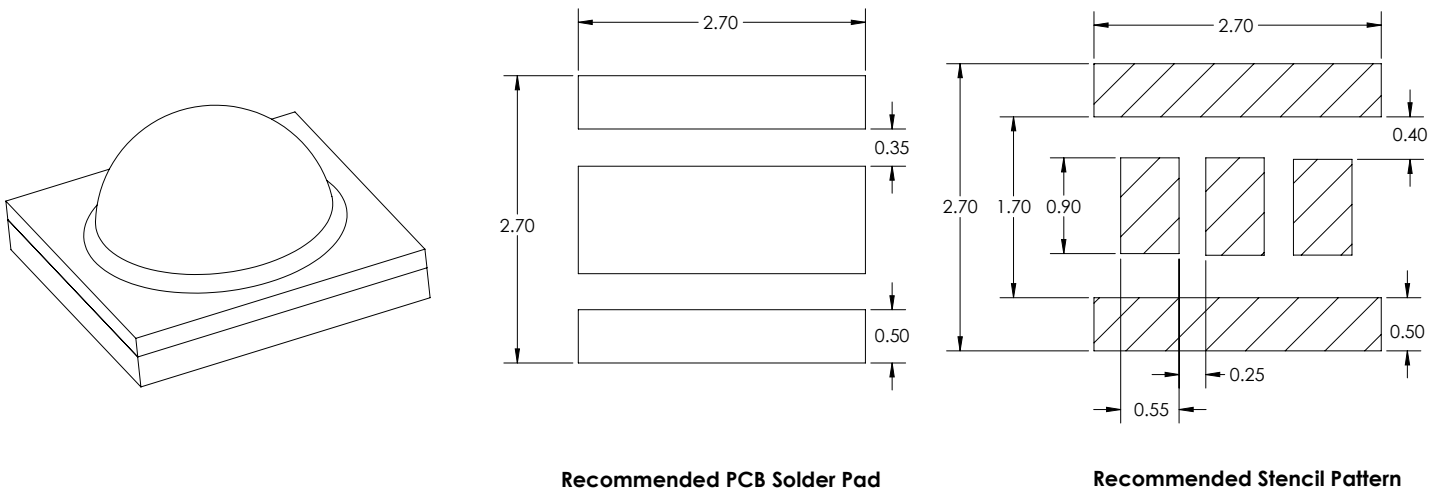

### Tape and Reel - A120 and B120 Package Configurations

All dimensions are in millimeter  $\pm 0.13$  mm

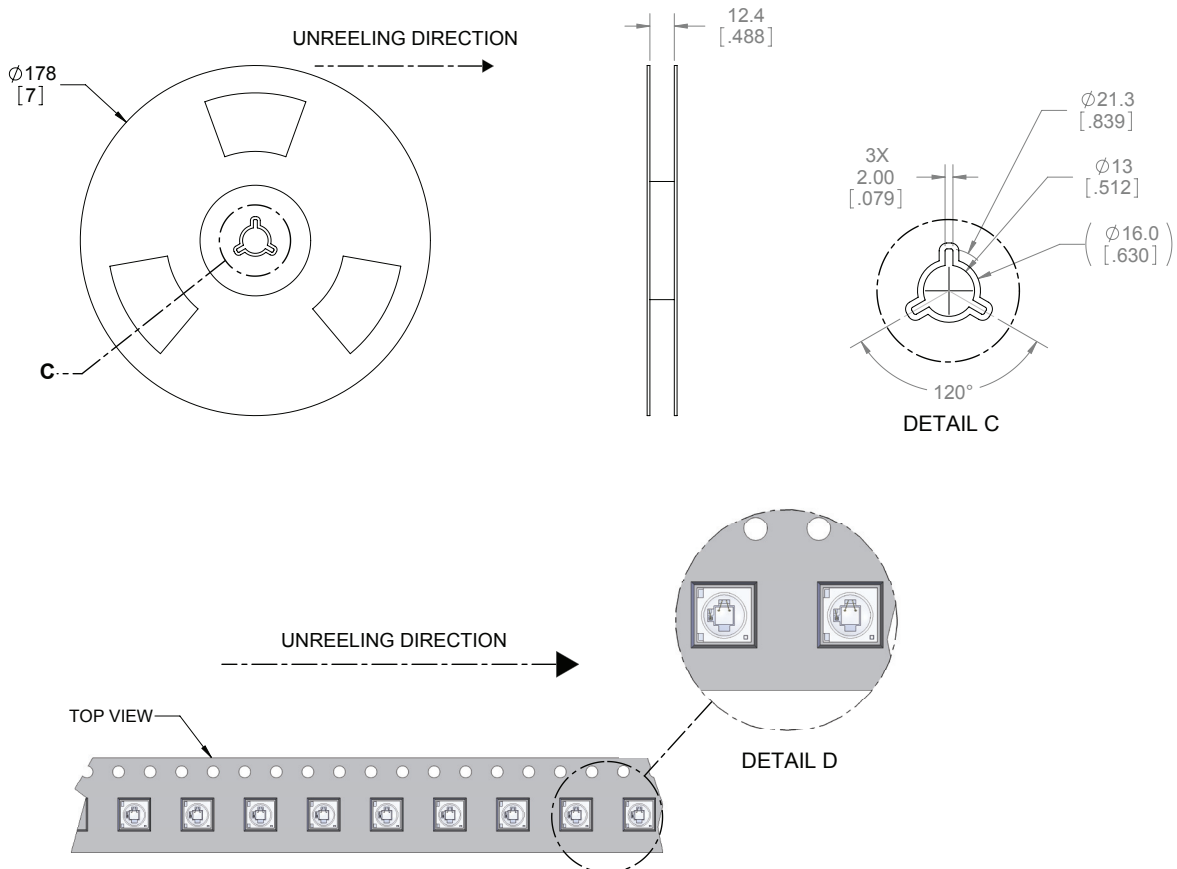
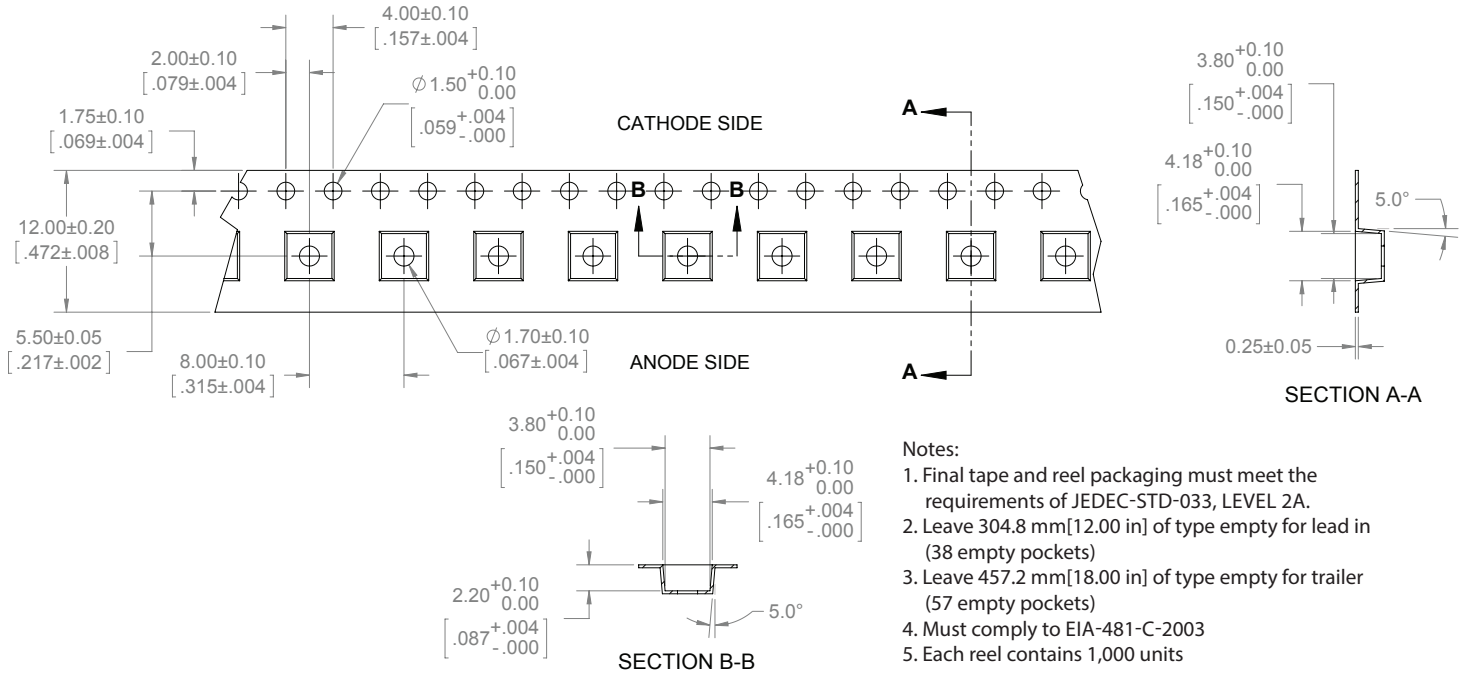

## Packaging and Labeling

### Packaged Reel

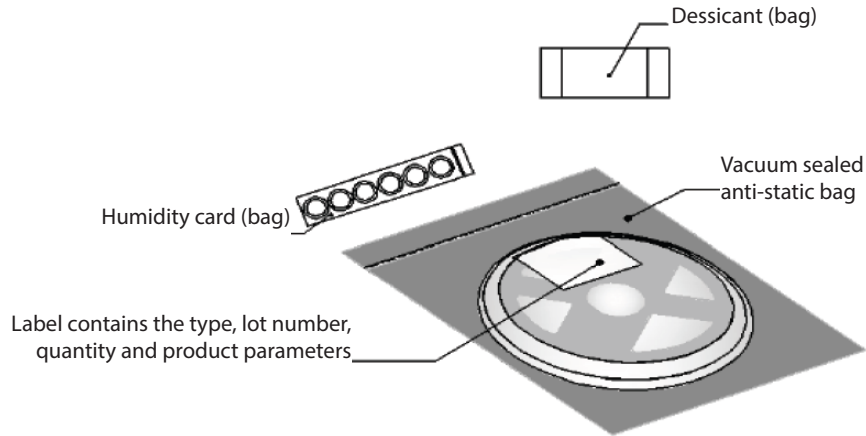

### Label on Reel

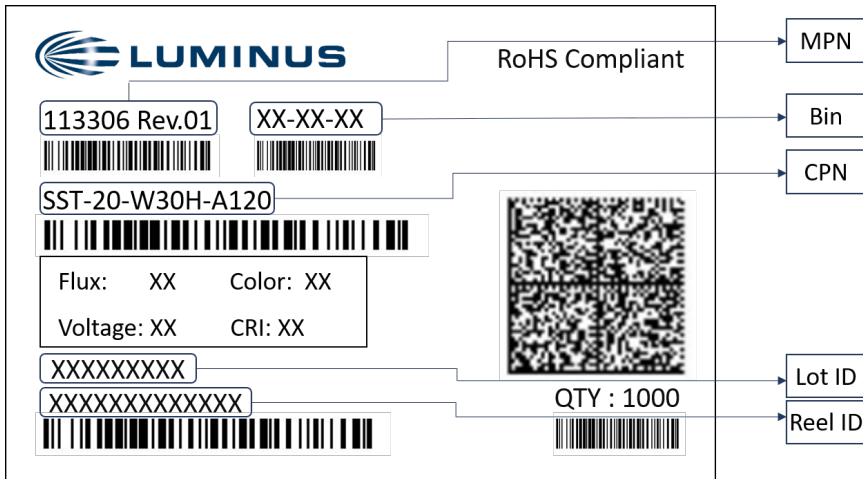

Label Information	
CPN	Luminus ordering part number
MPN	For Luminus internal use
QTY	Quantity of parts per reel
Flux	Single flux bin code (see <i>Luminous Flux Binning</i> table on page 3)
Voltage	Single voltage bin code (see <i>Forward Voltage Binning</i> table on page 3)
Color	Single chromaticity bin code (see <i>Chromaticity Bin Coordinates</i> table on page 4 and 5)
CRI	N/A
Lot ID & Reel ID	For Luminus internal use

### Packaging Boxes

**Box Size 1** - 5 reels per box  
 Size: 22.5 x 24.5 x 6.5 cm

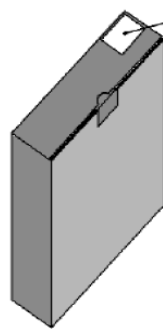
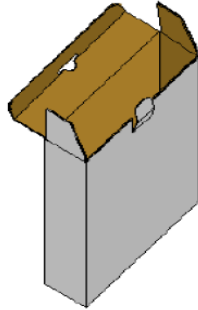

Label contains the type, lot number, quantity and product parameters

**Box Size 2** - 10 reels per box  
 Size: 22.5 x 24.5 x 13 cm

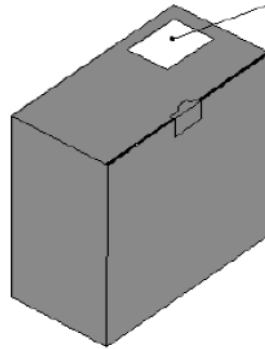
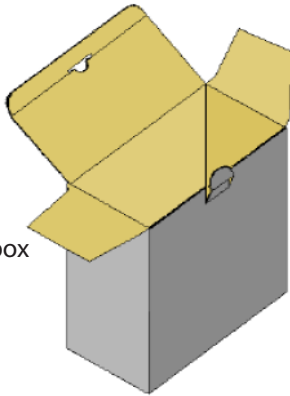

Label contains the type, lot number, quantity and product parameters

### Shipping Label on Packaging Box

Multiple labels are attached to the box (one label per reel inside the box)

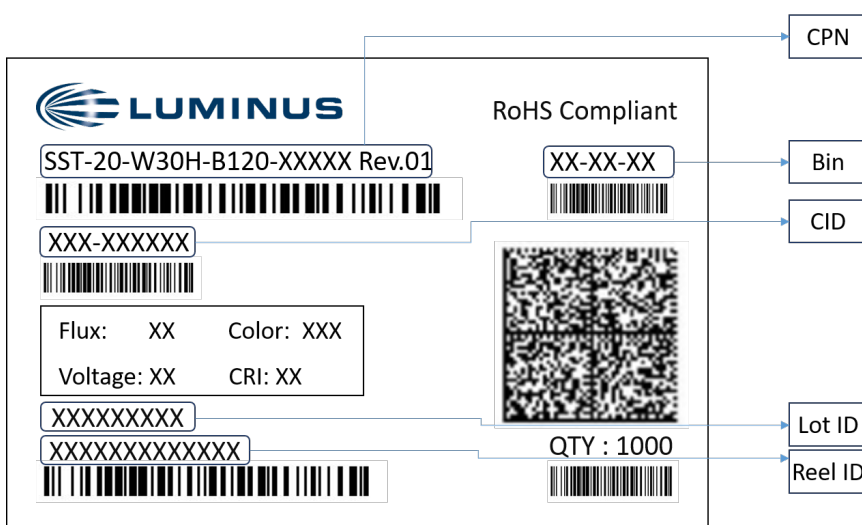

Label Information	
<b>CPN</b>	Luminus ordering part number
<b>CID</b>	Customer ID
<b>QTY</b>	Quantity of parts per reel
<b>Flux</b>	Single flux bin code (see <i>Luminus Flux Binning</i> table on page 3)
<b>Voltage</b>	Single voltage bin code (see <i>Forward Voltage Binning</i> table on page 3)
<b>Color</b>	Single chromaticity bin code (see <i>Chromaticity Bin Coordinates</i> table on page 4 and 5)
<b>CRI</b>	N/A
<b>Lot ID &amp; Reel ID</b>	For Luminus internal use



## X-ON Electronics

Largest Supplier of Electrical and Electronic Components

*Click to view similar products for [High Power LEDs - White category:](#)*

*Click to view products by [Luminus Devices manufacturer:](#)*

Other Similar products are found below :

[LTW-K140SZR40](#) [LTPL-P00DWS57](#) [LTW-K140SZR30](#) [LZP-D0WW00-0000](#) [JK2835AWT-00-0000-000B0HL227E-BLK](#) [LTW-K140SZR57](#) [LTW-K140SZR27](#) [BXRC-35E10K0-D-73](#) [MP-5050-6100-65-80](#) [KW CSLPM2.CC-8L8M-4L8N](#) [KW CSLPM2.CC-8L8M-4O9Q](#) [KW DPLS32.SB-6H6J-E5P7-EG-Z264](#) [L1V1-507003V500000](#) [BXRE-27E1000-C-83](#) [BXRE-27G0800-D-83](#) [BXRE-27G2000-B-83](#) [BXRE-50C2001-C-84](#) [BXRH-35S1001-B-73](#) [BXRH-30E0300-B-83](#) [BXRH-30E1000-G-83](#) [115780](#) [LM1311D4W-12B4C12\(Ra4\)-DS](#) [ELJU\(9\)-K40M3-0LTHE-R4000](#) [ELJU\(9\)-K40M3-0LTHE-R3000](#) [LM1311D4W-12B2C24\(Ra4\)-DS](#) [KW2 CFLNM2.TK-D2D9-4L07M0-SC6B](#) [XEGAWT-H2-0000-000-00000UT122G](#) [XHP35B-H0-0000-0D0ZA230G](#) [XHP35B-H0-0000-0D0ZA440G](#) [XHP35B-H0-0000-0D0ZA227G](#) [XHP35B-H0-0000-0D0ZA235G](#) [CTM-9-4018-90-36-TWD6-F3-3](#) [CVM-32-56-95-54-AC00-F2-2](#) [SST-12-W65S-A120-H4652](#) [CXM-4-24-90-18-AC40-F5-2](#) [CXM-4-22-90-18-AC40-F5-2](#) [LM002H384W-7B3C12\(Ra5\)\(ANSI-2700K\)](#) [LM002H384W-9B4C12\(Ra2\)\(ANSI-2700K\)](#) [LM002H384W-7B3C12\(Ra7\)\(ANSI-2700K\)](#) [LM002H384W-9B4C12\(Ra2\)\(ANSI-3000K\)](#) [LM002H384W-9B4C12\(Ra4\)-S\(ANSI-3500K\)](#) [LM002H384W-9B4C12\(Ra5\)\(ANSI-4000K\)](#) [LM002H384W-7B3C12\(Ra2\)-S\(ANSI-3000K\)](#) [LM002H384W-7B3C12\(Ra5\)\(ANSI-4000K\)](#) [LM002H384W-7B3C12\(Ra7\)\(ANSI-4000K\)](#) [HL-LM002H384W-5B2C5\(Ra4\)\(ANSI-3000K\)](#) [HL-LM002H384W-7B1C18\(Ra4\)\(ANSI-6000K\)](#) [LM002H384W-7B3C12\(Ra5\)\(ANSI-3500K\)](#) [HL-LM002H384W-5B2C5\(Ra4\)\(ANSI-4000K\)](#) [HL-LM002H384W-5B2C5\(Ra4\)\(ANSI-6000K\)](#)