

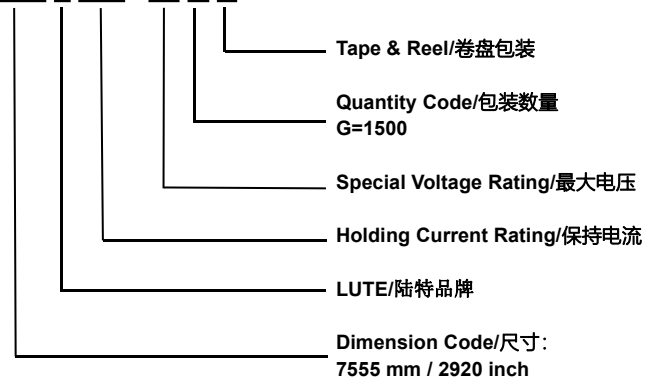

**Features/特征**

- Size 0.29\*0.20 inch / 7.5\*5.5 mm
- Surface mount resettable fuse
- Voltage rating 6V to 60V
- Current rating from 0.30A to 7A
- Fast time-to-trip
- Low resistance
- RoHS compliant, lead-free and halogen-free
- Compatible with high temperature solders

**Applications/应用**

- USB peripherals
- Plug and play protection for motherboards
- Power tools
- Battery and port protection for smart phones
- Game console port protection
- Set-top-boxes
- Tablets, notebooks, laptops and desktops
- Rechargeable battery packs
- Digital cameras
- Appliances and white goods
- Consumer electronics

**Part Number System/产品编号**
**2920 L 030 / 60 G R**

**Electrical Characteristics (25°C)/电性参数**

Part Number	Marking	I <sub>hold</sub> (A)	I <sub>trip</sub> (A)	V <sub>max</sub> (Vdc)	I <sub>max</sub> (A)	P <sub>d</sub> typ. (W)	Time to Trip (Max.)		Resistance	
							Current (A)	Time (Sec)	R <sub>min</sub> (Ω)	R <sub>1max</sub> (Ω)
2920L030/60GR	B030	0.30	0.60	60	40	1.8	1.50	3.0	0.600	4.800
2920L050/60GR	B050	0.50	1.00	60	40	1.8	2.50	4.0	0.180	1.400
2920L050/72GR	B050	0.50	1.00	72	15	2.5	2.50	4.0	0.180	1.400
2920L075/33GR	B075	0.75	1.50	33	40	1.8	8.00	0.3	0.100	1.000
2920L075/60GR	B075	0.75	1.50	60	40	1.8	8.00	0.3	0.100	1.000
2920L075/72GR	B075	0.75	1.50	72	40	1.8	8.00	0.3	0.100	1.000

Part Number	Marking	I <sub>hold</sub> (A)	I <sub>trip</sub> (A)	V <sub>max</sub> (Vdc)	I <sub>max</sub> (A)	P <sub>d</sub> typ. (W)	Time to Trip (Max.)		Resistance	
							Current (A)	Time (Sec)	R <sub>min</sub> (Ω)	R <sub>1max</sub> (Ω)
2920L100/33GR	B100	1.10	2.20	33	40	1.8	8.00	0.5	0.065	0.410
2920L100/60GR	B100	1.10	2.20	60	15	2.5	8.00	0.5	0.065	0.410
2920L100/72GR	B100	1.10	2.20	72	15	2.5	8.00	0.5	0.065	0.410
2920L125/33GR	B125	1.25	2.50	33	40	1.8	8.00	2.0	0.050	0.250
2920L125/48GR	B125	1.25	2.50	48	15	2.5	8.00	2.0	0.050	0.250
2920L125/60GR	B125	1.25	2.50	60	15	2.5	8.00	2.0	0.050	0.250
2920L150/33GR	B150	1.50	3.00	33	40	1.8	8.00	2.0	0.035	0.230
2920L150/48GR	B150	1.50	3.00	48	15	2.5	8.00	2.0	0.035	0.230
2920L150/60GR	B150	1.50	3.00	60	15	2.5	8.00	2.0	0.035	0.230
2920L185/33GR	B185	1.85	3.70	33	40	2.0	8.00	2.5	0.030	0.150
2920L185/48GR	B185	1.85	3.70	48	40	2.0	8.00	2.5	0.030	0.150
2920L200/16GR	B200	2.00	4.00	16	40	2.0	8.00	4.5	0.020	0.120
2920L200/24GR	B200	2.00	4.00	24	40	2.0	8.00	4.5	0.020	0.120
2920L200/33GR	B200	2.00	4.00	33	40	2.0	8.00	4.5	0.020	0.120
2920L200/48GR	B200	2.00	4.00	48	40	2.0	8.00	4.5	0.020	0.120
2920L250/16GR	B250	2.50	5.00	16	40	2.0	8.00	10	0.020	0.085
2920L250/24GR	B250	2.50	5.00	24	40	2.0	8.00	10	0.020	0.085
2920L250/33GR	B250	2.50	5.00	33	40	2.0	8.00	10	0.020	0.085
2920L260/6GR	B260	2.60	5.00	6	40	2.0	8.00	10	0.014	0.075
2920L260/16GR	B260	2.60	5.00	16	40	2.0	8.00	10	0.014	0.075
2920L260/24GR	B260	2.60	5.00	24	40	2.0	8.00	10	0.014	0.075
2920L260/33GR	B260	2.60	5.00	33	40	2.0	8.00	10	0.014	0.075
2920L300/6GR	B300	3.00	5.00	6	40	2.0	8.00	20	0.012	0.048
2920L300/16GR	B300	3.00	5.00	16	40	2.0	8.00	20	0.012	0.048
2920L300/24GR	B300	3.00	5.00	24	40	2.0	8.00	20	0.012	0.048
2920L300/30GR	B300	3.00	5.00	30	40	2.0	8.00	20	0.012	0.048
2920L300/33GR	B300	3.00	5.00	33	40	2.0	8.00	20	0.012	0.048
2920L330/24GR	B330	3.30	5.50	24	40	2.0	8.00	20	0.015	0.055
2920L330/33GR	B330	3.30	5.50	33	40	2.0	8.00	20	0.015	0.055
2920L400/6GR	B400	4.00	8.00	6	40	2.5	20.0	4	0.008	0.040
2920L400/16GR	B400	4.00	8.00	16	40	2.5	20.0	4	0.008	0.040
2920L400/24GR	B400	4.00	8.00	24	40	2.5	20.0	4	0.008	0.040
2920L400/30GR	B400	4.00	8.00	30	40	2.5	20.0	4	0.008	0.040
2920L500/6GR	B500	5.00	10.00	6	40	2.5	25.0	5	0.005	0.031
2920L500/12GR	B500	5.00	10.00	12	40	2.5	25.0	5	0.005	0.031
2920L500/16GR	B500	5.00	10.00	16	40	2.5	25.0	5	0.005	0.031
2920L500/24GR	B500	5.00	10.00	24	40	2.5	25.0	5	0.005	0.031
2920L500/30GR	B500	5.00	10.00	30	40	2.5	25.0	5	0.005	0.031

Part Number	Marking	I <sub>hold</sub> (A)	I <sub>trip</sub> (A)	V <sub>max</sub> (Vdc)	I <sub>max</sub> (A)	P <sub>d</sub> typ. (W)	Time to Trip (Max.)		Resistance	
							Current (A)	Time (Sec)	R <sub>min</sub> (Ω)	R <sub>1max</sub> (Ω)
2920L600/6GR	B600	6.00	12.00	6	40	2.5	25.0	6	0.004	0.020
2920L600/12GR	B600	6.00	12.00	12	40	2.5	25.0	6	0.004	0.020
2920L600/16GR	B600	6.00	12.00	16	40	2.5	25.0	6	0.004	0.020
2920L700/6GR	B700	7.00	14.00	6	40	2.5	25.0	6	0.0025	0.010
2920L700/12GR	B700	7.00	14.00	12	40	2.5	25.0	6	0.0025	0.010

I<sub>hold</sub> = Hold current: maximum current device will pass without tripping in 25°C still air. 保持电流=在 25°C 静止空气环境中,元件不动作的最大电流。  
 I<sub>trip</sub> = Trip current: minimum current at which the device will trip in 25°C still air. 动作电流=在 25°C 静止空气环境中,元件的最小动作电流。  
 V<sub>max</sub> = Maximum voltage device can withstand without damage at rated current (I<sub>max</sub>). 最大电压=元件在额定电流下能承受的最大电压。  
 I<sub>max</sub> = Maximum fault current device can withstand without damage at rated voltage (V<sub>max</sub>). 最大电流=元件在额定电压下能承受的最大电流。  
 P<sub>d</sub> typ. = Typical power dissipated from device when in the tripped state at 25°C still air. 动作功率=在 25°C 静止空气环境中,元件动作状态下的消耗功率。  
 T<sub>trip</sub> = Maximum time to trip(s) at assigned current reflow soldering of 260°C for 20 sec. 动作时间=5 倍保持电流下的最大动作时间。  
 R<sub>min</sub> = Minimum resistance of device in initial (un-soldered) state. 初始最小电阻=元件焊接前的初始最小阻值。  
 R<sub>1max</sub> = Maximum resistance of device at 25°C measured one hour after tripping or reflow soldering of 260°C for 20 sec. 焊后最大电阻=元件焊接 1 小时后的最大阻值。

**Caution** : Operation beyond the specified rating may result in damage and possible arcing and flame. 注意: 超出指定额定值的操作, 可能会导致损伤并可能产生电弧和火焰。

Product Dimensions (mm)/产品尺寸

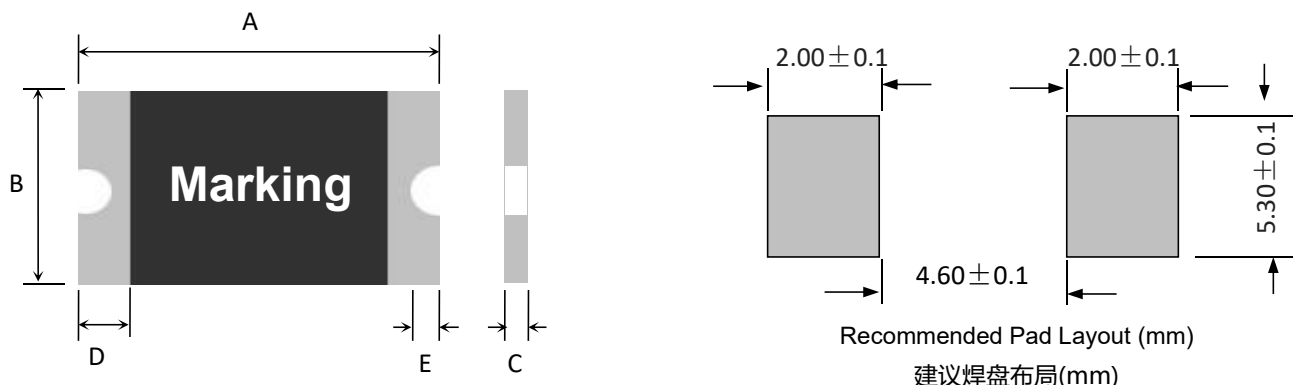

Part Number	Quantity	A		B		C		D	E
		Min	Max	Min	Max	Min	Max	Min	Min
2920L030/60GR	1500	6.73	7.98	4.80	5.44	0.60	1.20	0.6	0.30
2920L050/60GR	1500	6.73	7.98	4.80	5.44	0.60	1.20	0.6	0.30
2920L050/72GR	1500	6.73	7.98	4.80	5.44	0.60	1.20	0.6	0.30
2920L075/33GR	1500	6.73	7.98	4.80	5.44	0.70	1.30	0.6	0.30
2920L075/60GR	1500	6.73	7.98	4.80	5.44	0.70	1.30	0.6	0.30
2920L075/72GR	1500	6.73	7.98	4.80	5.44	0.70	1.30	0.6	0.30
2920L100/33GR	1500	6.73	7.98	4.80	5.44	0.40	1.00	0.6	0.30
2920L100/60GR	1500	6.73	7.98	4.80	5.44	0.60	1.20	0.6	0.30
2920L100/72GR	1500	6.73	7.98	4.80	5.44	0.60	1.20	0.6	0.30
2920L125/33GR	1500	6.73	7.98	4.80	5.44	0.40	1.00	0.6	0.30

Part Number	Quantity	A		B		C		D	E
		Min	Max	Min	Max	Min	Max	Min	Min
2920L125/48GR	1500	6.73	7.98	4.80	5.44	0.40	1.00	0.6	0.30
2920L125/60GR	1500	6.73	7.98	4.80	5.44	0.40	1.00	0.6	0.30
2920L150/33GR	1500	6.73	7.98	4.80	5.44	0.50	1.30	0.6	0.30
2920L150/48GR	1500	6.73	7.98	4.80	5.44	0.50	1.30	0.6	0.30
2920L150/60GR	1500	6.73	7.98	4.80	5.44	0.50	1.30	0.6	0.30
2920L185/33GR	1500	6.73	7.98	4.80	5.44	0.70	1.40	0.6	0.30
2920L185/48GR	1500	6.73	7.98	4.80	5.44	0.70	1.40	0.6	0.30
2920L200/16GR	1500	6.73	7.98	4.80	5.44	0.70	1.40	0.6	0.30
2920L200/24GR	1500	6.73	7.98	4.80	5.44	0.70	1.40	0.6	0.30
2920L200/33GR	1500	6.73	7.98	4.80	5.44	0.70	1.40	0.6	0.30
2920L200/48GR	1500	6.73	7.98	4.80	5.44	0.70	1.40	0.6	0.30
2920L250/16GR	1500	6.73	7.98	4.80	5.44	0.70	1.40	0.6	0.30
2920L250/24GR	1500	6.73	7.98	4.80	5.44	0.70	1.40	0.6	0.30
2920L250/33GR	1500	6.73	7.98	4.80	5.44	0.70	1.40	0.6	0.30
2920L260/6GR	1500	6.73	7.98	4.80	5.44	0.70	1.40	0.6	0.30
2920L260/16GR	1500	6.73	7.98	4.80	5.44	0.70	1.40	0.6	0.30
2920L260/24GR	1500	6.73	7.98	4.80	5.44	0.70	1.40	0.6	0.30
2920L260/33GR	1500	6.73	7.98	4.80	5.44	0.70	1.40	0.6	0.30
2920L300/6GR	1500	6.73	7.98	4.80	5.44	0.60	1.20	0.6	0.30
2920L300/16GR	1500	6.73	7.98	4.80	5.44	0.60	1.20	0.6	0.30
2920L300/24GR	1500	6.73	7.98	4.80	5.44	0.60	1.60	0.6	0.30
2920L300/30GR	1500	6.73	7.98	4.80	5.44	0.60	1.60	0.6	0.30
2920L300/33GR	1500	6.73	7.98	4.80	5.44	0.60	1.60	0.6	0.30
2920L330/24GR	1500	6.73	7.98	4.80	5.44	0.60	1.60	0.6	0.30
2920L330/33GR	1500	6.73	7.98	4.80	5.44	0.60	1.60	0.6	0.30
2920L400/6GR	1500	6.73	7.98	4.80	5.44	1.00	1.60	0.6	0.30
2920L400/16GR	1500	6.73	7.98	4.80	5.44	1.00	1.60	0.6	0.30
2920L400/24GR	1500	6.73	7.98	4.80	5.44	1.00	1.60	0.6	0.30
2920L400/30GR	1500	6.73	7.98	4.80	5.44	1.00	1.60	0.6	0.30
2920L500/6GR	1500	6.73	7.98	4.80	5.44	1.00	1.60	0.6	0.30
2920L500/12GR	1500	6.73	7.98	4.80	5.44	1.00	1.60	0.6	0.30
2920L500/16GR	1500	6.73	7.98	4.80	5.44	1.00	1.60	0.6	0.30
2920L500/24GR	1500	6.73	7.98	4.80	5.44	1.00	1.60	0.6	0.30
2920L500/30GR	1500	6.73	7.98	4.80	5.44	1.00	1.60	0.6	0.30
2920L600/6GR	1500	6.73	7.98	4.80	5.44	1.00	1.60	0.6	0.30
2920L600/12GR	1500	6.73	7.98	4.80	5.44	1.00	1.60	0.6	0.30
2920L600/16GR	1500	6.73	7.98	4.80	5.44	1.00	1.60	0.6	0.30
2920L700/6GR	1500	6.73	7.98	4.80	5.44	1.00	1.60	0.6	0.30
2920L700/12GR	1500	6.73	7.98	4.80	5.44	1.00	1.60	0.6	0.30

## Environmental Specifications/环境规范

Test 测试项目	Conditions 条件	Resistance change 电阻变化
Passive aging 被动老化	+85°C, 1000 hours	±5% typical
Humidity aging 湿热老化	+85°C, 85% R.H. , 168 hours	±5% typical
Thermal shock 冷热冲击	+85°C to -40°C, 20 times	±33% typical
Resistance to solvent 抗溶剂性能	MIL-STD-202,Method 215	No change
Vibration 抗震性	MIL-STD-202,Method 201	No change
<b>Ambient operating conditions : - 40 °C to +85 °C</b> 工作环境温度		
<b>Maximum surface temperature of the device in the tripped state is 125°C.</b> 保护状态下的元件表面最高温度为 125°C		

Temperature Derating/不同环境温度下的 I<sub>hold</sub> 值

Part Number	Ambient operating temperature hold current (I <sub>hold</sub> )								
	-40°C	-20°C	0°C	25°C	40°C	50°C	60°C	70°C	85°C
2920L030	0.45	0.40	0.35	0.30	0.25	0.23	0.20	0.17	0.14
2920L050	0.76	0.67	0.59	0.50	0.42	0.38	0.33	0.29	0.23
2920L075	1.13	1.01	0.88	0.75	0.62	0.56	0.50	0.44	0.34
2920L100	1.66	1.47	1.29	1.10	0.91	0.83	0.73	0.64	0.50
2920L125	1.89	1.68	1.46	1.25	1.04	0.94	0.83	0.73	0.56
2920L150	2.27	2.01	1.76	1.50	1.25	1.13	1.00	0.87	0.74
2920L185	2.80	2.47	2.17	1.85	1.54	1.39	1.22	1.07	0.85
2920L200	3.02	2.68	2.34	2.00	1.66	1.50	1.32	1.16	0.90
2920L250	3.64	3.25	2.91	2.50	2.08	1.88	1.65	1.45	1.13
2920L260	3.78	3.35	2.93	2.60	2.26	2.08	1.95	1.74	1.18
2920L300	4.53	4.02	3.51	3.00	2.52	2.26	1.99	1.79	1.34
2920L330	4.60	4.20	3.75	3.30	2.95	2.75	2.50	2.25	1.70
2920L400	6.04	5.36	4.68	4.00	3.36	3.01	2.65	2.33	1.79
2920L500	7.55	6.70	5.85	5.00	4.20	3.77	3.32	2.92	2.23
2920L600	8.60	7.70	6.80	6.00	4.95	4.60	4.06	3.65	3.15
2920L700	10.03	8.98	7.93	7.00	5.77	5.36	4.73	4.26	3.68

Thermal Derating Curve/环境温度与工作电流关系特性图

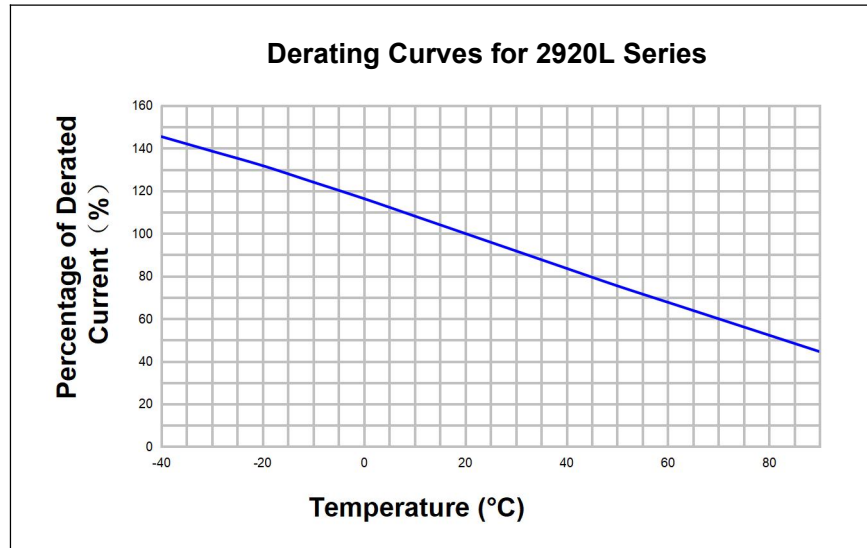

Typical Time-to-Trip at 25°C/25°C跳闸保护时间曲线表

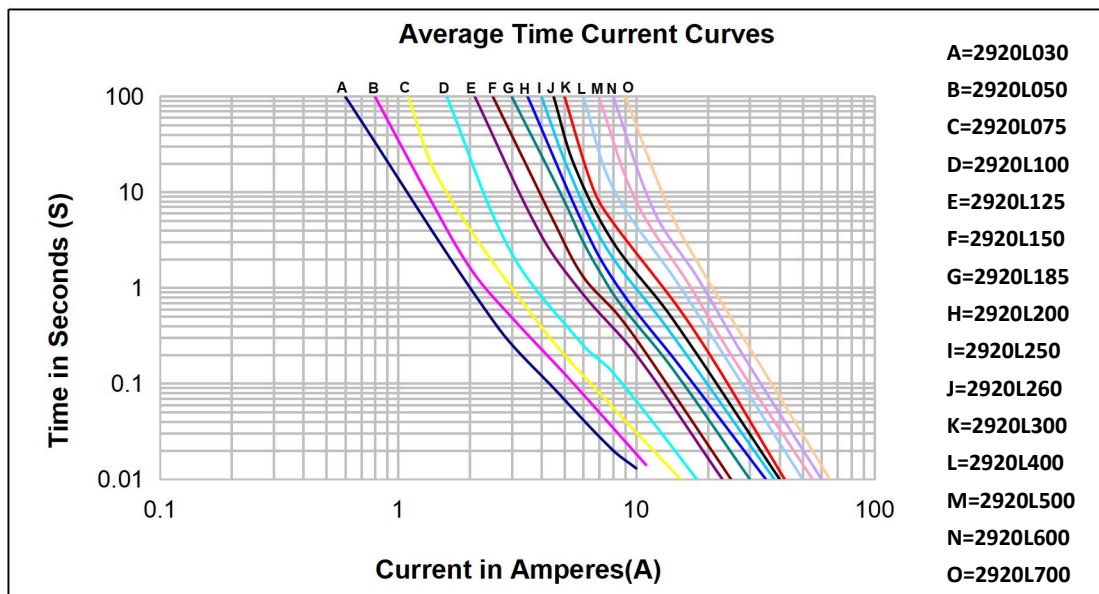

Soldering Parameters/焊接参数

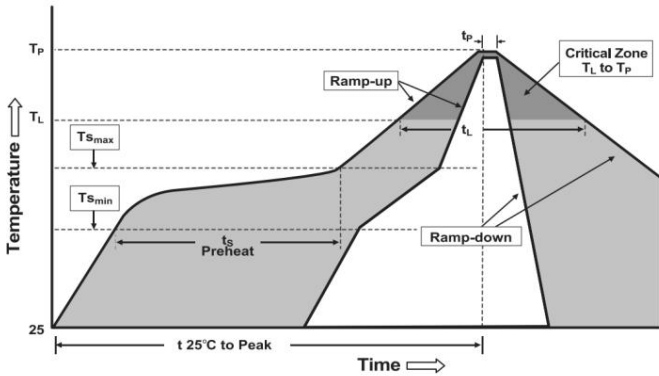

- Recommended reflow methods: IR, vapor phase oven, hot air oven, N<sub>2</sub> environment for lead-free;  
推荐的回流方法: 红外光谱, 气相炉, 热空气炉中, 氮气环境, 无铅焊接;
  - Recommended maximum paste thickness is 0.25mm;  
推荐刷锡厚度最大为 0.25mm;
  - Devices can be cleaned using standard industry methods and solvents;  
产品可以使用行业标准的方法和溶剂清洗;
- Note 1:** All temperature refer to topside of the package, measured on the package body surface;  
注 1: 所有的温度是在焊接时, 在产品上所测量出来;
- Note 2:** If reflow temperatures exceed the recommended profile, devices may not meet the performance requirements.  
注 2: 如果回流温度超过推荐参数要求, 产品可能无法满足性能要求.

Profile Feature 特征	Pb-Free Assembly 无铅焊锡	
<b>Average Ramp-Up Rate (T<sub>s(max)</sub> to T<sub>p</sub>)</b> 平均升温速度	3°C/second max	
<b>Preheat 预热</b>	<b>-Temperature Min(T<sub>s(min)</sub>)</b> 最低温度	150°C
	<b>-Temperature Max(T<sub>s(max)</sub>)</b> 最高温度	200°C
	<b>-Time(T<sub>s(min)</sub> to T<sub>s(max)</sub>)</b> 预热时间	60~180 seconds
<b>Time maintained above: 保持时间</b>	<b>-Temperature(T<sub>l</sub>) 温度</b>	217°C
	<b>-Time(t<sub>l</sub>) 时间</b>	60~150 seconds
<b>Peak Temperature (T<sub>p</sub>) 峰值温度</b>	260°C	
<b>Time within 5°C of actual Peak : Temperature (tp)</b>	20-40 seconds	
<b>Ramp-Down Rate 降温</b>	6°C/second max	
<b>Time 25°C to Peak Temperature</b> 从 25°C到峰值温度时间	8 minutes max	
<b>Storage Condition</b> 储存条件	0°C~30°C 30%-60%RH	

Tape And Reel Specifications (mm)/料带和卷盘规格

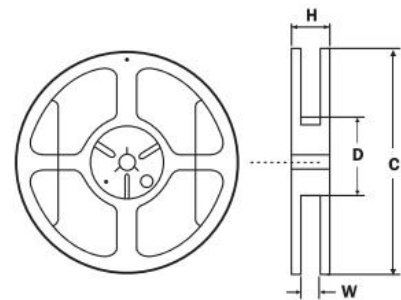
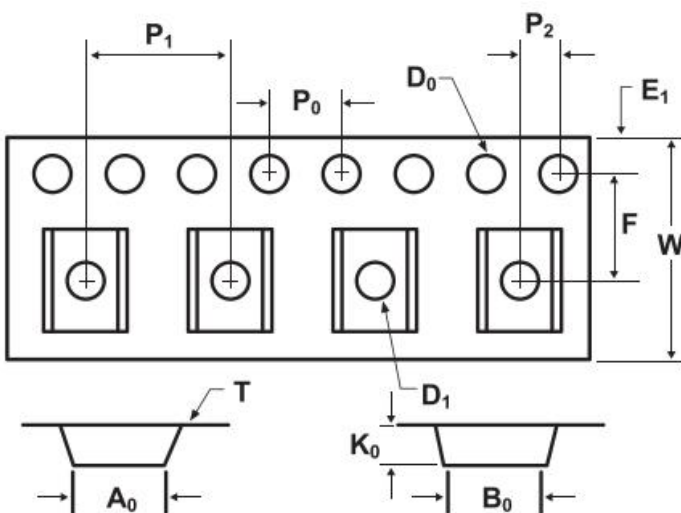

Reel Dimensions 卷盘规格

<b>C</b>	φ178 ± 1.0
<b>D</b>	φ60.2 ± 0.5
<b>H</b>	16.0 ± 0.5
<b>W</b>	13.2 ± 1.5

Governing Specifications 料带规格	2920L030	2920L125	2920L200	2920L400
	2920L050	2920L150	2920L250	2920L500
	2920L075	2920L185	2920L260	2920L600
	2920L100		2920L300	2920L700
			2920L330	
<b>W</b>	16.0 ± 0.3		16.0 ± 0.3	
<b>F</b>	7.5 ± 0.05		7.5 ± 0.05	
<b>E1</b>	1.75 ± 0.1		1.75 ± 0.1	
<b>D0</b>	1.55 ± 0.05		1.55 ± 0.05	
<b>D1</b>	1.55min		1.55min	
<b>P0</b>	4.0 ± 0.1		4.0 ± 0.1	
<b>P1</b>	8.0 ± 0.1		8.0 ± 0.1	
<b>P2</b>	2.0 ± 0.05		2.0 ± 0.05	
<b>A0</b>	5.74 ± 0.1		5.74 ± 0.1	
<b>B0</b>	8.02 ± 0.1		8.02 ± 0.1	
<b>T</b>	0.3 ± 0.1		0.3 ± 0.1	
<b>K0</b>	1.04 ± 0.1		1.35 ± 0.1	
<b>Leader</b> min	390		390	
<b>Trailer</b> min	160		160	

**WARNING**

- Users shall independently assess the suitability of these devices for each of their applications.
- Users shall independently assess the suitability of these devices for each of their applications.
- Operation of these devices beyond the stated maximum ratings could result in damage to the devices and lead to electrical arcing and/or fire.
- These devices are intended to protect against the effects of temporary over-current or over-temperature Conditions and are not intended to perform as protective devices where such conditions are expected to be repetitive or prolonged in duration.
- Exposure to silicon-based oils, solvents, electrolytes, acids, and similar materials can adversely affect the prolonged of these PPTC devices.
- These devices undergo thermal expansion under fault conditions, and thus shall be provided with adequate space and be protected against mechanical stresses.
- Circuits with inductance may generate a voltage (L di/dt) above the rated voltage of the PPTC device.



## Cautions for SMD PTC Use/贴片 PTC 使用注意事项

1. PTC Device is a resettable overcurrent circuit protection device used to protect against overcurrent faults in electronic circuits. It cannot be used as a switch, and multiple times tripping will reduce the PTC hold current.

PTC 器件是一种可复位的过流电路保护元件，用于保护电子电路中的过流故障。不能作为开关使用，重复多次保护会降低 PTC 的维持电流。

2. The PTC is a thermally sensitive device with a positive temperature coefficient which means that the resistance increases with increasing temperature. It is recommended to keep away from heat source devices when designing to minimize the influence of external heat sources.

PTC 是一种具有正温度系数的热敏器件，即电阻随温度升高而增大。设计时建议远离热源器件，尽量减少外部热源的影响。

3. This product should not be used in an application where the maximum voltage or maximum current can be exceeded in a fault condition. Operation beyond the maximum ratings or improper use may result in device damage and possible electrical arcing and flame.

本产品不应用于在故障条件下可能超过最大电压或最大电流的应用中。超出最大额定值的操作或不当使用可能会导致 PTC 损坏，出现电弧现象，甚至烧毁。

4. Hold current at all temperature specified in the specification is the conventional performance of PTC obtained by one reflow soldering. It can hold 1 hour under the current conditions corresponding to different temperatures. This current is not the condition of long-term charging or discharging current for this type of PTC.

规格书中所规定的各温度下的维持电流是 PTC 通过一次回流焊接后获得的常规性能。PTC 在不同温度对应的当前电流条件下可保持 1 小时。该电流并不是该型号 PTC 能够适应的长期充电或放电电流的条件。

5. The resistance and other electrical parameters indicated in the specification are all based on the test results of the manufacturer's designated test board by one reflow soldering. If there is any further heat generated process like multiple soldering, injection molding, dispensing, the product parameters will decrease at certain degree. Therefore the verification test to be conducted is necessary.

规格书中的电阻等电气参数均以厂家指定测试板一次回流焊的测试结果为准。如果有进一步的发热过程，如多次焊接、注塑、点胶等，产品参数会有所衰减。因此需要进行验证测试其适用性。

6. SMD PTC is designed for the SMT process which applies reflow soldering. For reflow soldering, please refer to the recommended curve diagram. If the recommended value is exceeded, the internal resistance of PTC may increase. Hand soldering is not recommended and heat gun is not allowed to use during the circuit boards rework. If there is soldering iron welding process, it is recommended that the welding position should be more than 1.5mm away from PTC, the welding temperature should be lower than 350°C, and the contact time with the solder joint should not exceed 3 seconds.

SMD PTC 是为采用回流焊接的 SMT 工艺设计的。焊接工艺请参考厂家推荐的回流焊曲线图。如果超过推荐值，PTC 的内阻可能会增加并受到损伤。禁止使用手工焊接，禁止电路板返工时使用热风枪。如果有烙铁焊接工艺，建议焊接位置离 PTC 1.5mm 以上，焊接温度低于 350°C，与焊点接触时间不超过 3 秒。

7. When mounting or using PTC, all injection molding materials, curing adhesives, UV glue, silica gel and cleaning agents or solvents must be tested in terms of application parameters e.g. temperature, time, and etc to ensure the consistency between the product and the processing before use.

贴装或应用 PTC 时，所有注塑材料、固化粘合剂、UV 胶、硅胶和清洁剂或溶剂都必须在应用参数方面进行测试，例如温度、时间等，以保证产品及工艺的匹配性，确认不会影响 PTC 性能之后方可使用。

8. When mounting or using PTC, it is not recommended to use circuit board washer water or other cleaning agent. If cleaning is required, it is necessary to verify the applicability of various cleaning agents, washboard water and solvents, and confirm that they will not affect the PTC performance. The known chemicals that impacts PTC include but not limited to ethers, benzene homolog, ketones, lipids and derivatives that is of strong solubleness and ruinous. Please place the product in open environment for at least 24 hours to volatilize solvents residuals.

贴装或应用 PTC 时，不建议使用电路板清洗水或其他清洁剂。如果需要清洗时，需要验证各种清洗剂、洗板水和溶剂的适用性，并确认它们不会影响 PTC 性能。已知的影响 PTC 的化学药品包括但不限于醚类、苯同系物、酮类、脂类和具有强溶解性和破坏性的有机化合物。清洗后请将产品放置在开放环境中至少 24 小时以充分挥发溶剂残留物。

9. When PTC is welded to the PCB in product application, if injection or gluing is needed, it should be completed in as short a time as possible. If the time slot between mounting and injection or gluing surpasses 1 month, please keep in airtight environment to avoid long air exposure.

产品应用中 PTC 焊接到 PCB 后，如需注胶或胶合，应在尽可能短的时间内完成。如果贴装和注塑或涂胶之间的时间间隔超过 1 个月，请密封保存，避免 PTC 长时间暴露在空气中。

10. In charging terminal application, PP type material is recommended to use as inner membrane and TPE and PVC type material is inhibited.

PTC 在充电终端应用中，建议使用 PP 类材料作为内膜，禁止使用 TPE 类和 PVC 类材料。

11. LUTE SMD PTC humidity sensitivity grade 2, for sealed packaging. If customers find damaged packaging in stock, they should isolate the product immediately. If there is any surplus material, they needs to be restored to the previous packaging state and do sealed storage.

陆特 SMD PTC 湿敏度为 2 级且为密封包装。如果客户发现库存中包装损坏，应立即将产品隔离。使用时如有余料，需恢复成之前的包装状态，并且密封保存。

## X-ON Electronics

Largest Supplier of Electrical and Electronic Components

*Click to view similar products for [Resettable Fuses - PPTC](#) category:*

*Click to view products by [LUTE](#) manufacturer:*

Other Similar products are found below :

[RF0077-000](#) [RF0627-000](#) [RF3301-000](#) [RF3382-000](#) [RF3394-000](#) [RF3399-000](#) [SMD125-2](#) [RF1973-000](#) [RF2531-000](#) [RF2873-000](#) [RF3060-000](#) [RF3311-000](#) [TR600-150Q-B-0.5-0.130](#) [RXE090](#) [5E4795/04-1502](#) [TRF250-080T-B-1.0-0.125](#) [SMD100-2](#) [NIS5431MT1TXG](#) [SMD250-2](#) [RS30-090](#) [RS30-600](#) [RS30-800](#) [RS30-900](#) [RS60RB-160](#) [RS60SB-250](#) [SB250-145](#) [K30U400](#) [0ZCH0110AF2E](#) [BK60-110-DI-E0.6](#) [BK250-120-SZ-E0.6](#) [BK60-010-DI-E0.5](#) [BK250-040-DY-E0.6](#) [RF2631-000](#) [NIS4461MT3TXG](#) [NIS5420MT2TXG](#) [NIS5420MT3TXG](#) [NIS6420MT1TWG](#) [RF5032-000](#) [RF5051-000](#) [RF5105-000](#) [RF5062-000](#) [RF5055-000](#) [RF5052-000](#) [2920L075/72MR](#) [BSMD0603-025-24V](#) [BSMD0402L-005](#) [BSMD0603-010-9V](#) [BSMD1812-020-60V](#) [BSMD2920-400-30V](#) [BSMD0603-010-12V](#)