

**5V Input 1.5A/2A(Peak) 2.5MHz Synchronous Step-Down Converter**

**DESCRIPTION**

The MT83121 is a 2.5MHz, 2A Peak constant on-time (COT) controlled synchronous step-down converter. It can operate with input voltage from 2.5V to 6V and provide output range from 0.6V to input level, thanks to its 100% duty cycle operation. The constant on-time control scheme simplifies loop compensation and offers excellent load transient response. MT83121 consumes extremely low 15µA quiescent current hence achieves superior light load efficiency. The high gain error amplifier in the control loop provides excellent load and line regulation. Proprietary adaptive on-time helps MT83121 to achieve nearly constant switching frequency across load range. MT83121 has cycle-by-cycle current limit and hiccup mode to protect over-load or short circuit fault conditions. MT83121 is available in low profile 5 leads SOT23 package.

**FEATURES**

- Wide Input Range from 2.5V to 6V
- Proprietary Fast Transient Constant On Time Architecture Stable with low ESR Ceramic Output Capacitors
- +/- 2% 0.6V Feedback Voltage
- 2.5MHz Switching Frequency
- 15µA Low Quiescent Current
- 1.5A Continuous and 2A Peak Output Current
- 100% Duty Cycle Operation
- Built-in 260mΩ/180mΩ Power Switches
- Internal 1msec Soft-Start
- Cycle-by-cycle Current Limit Protection
- Over-Load and Short Circuit Hiccup Mode
- Input Under/Over Voltage Lockout
- Output Discharging Function in Shutdown
- Thermal Shutdown Protection
- Hiccup Mode for Short Circuit and Over-Load Protection
- Available in SOT23\_5L Package
- Pb-Free RoHS Compliant

**APPLICATIONS**

- Solid-State and Hard Disk Drives
- WiFi RF Modules
- DC/DC Micro Modules
- Smart Phone and Tablets

**TYPICAL APPLICATION**

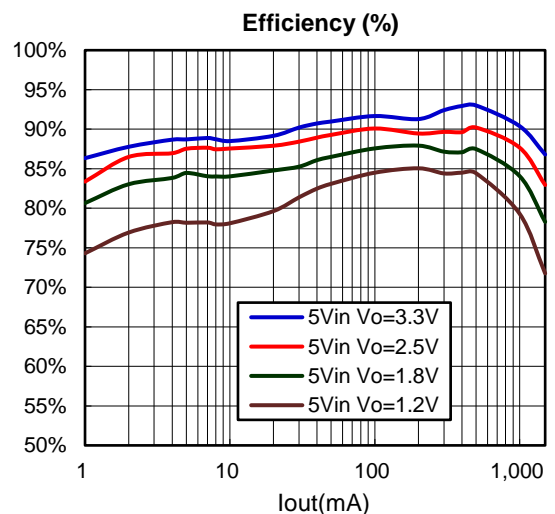
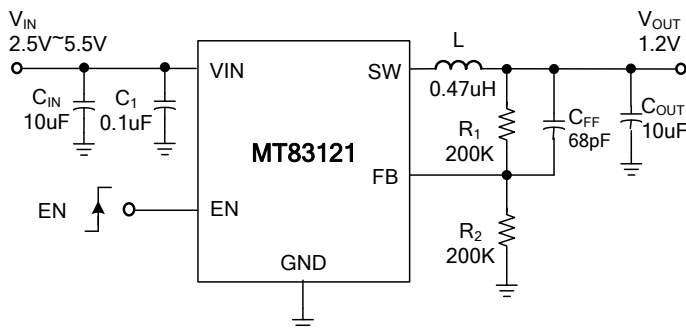

**5V Input 1.5A/2A(Peak) 2.5MHz Synchronous Step-Down Converter**

**Ordering Information**

Part No.	Marking	Temp. Range	Remark	Package	MOQ
MT83121NSBR	3121 YWWxx	-40°C ~+85°C	Adjustable Vout	SOT23_5L	3000/Tape & Reel

Note: Y:Year, W:Week, x:Manufacture Code

**Pin Configuration**

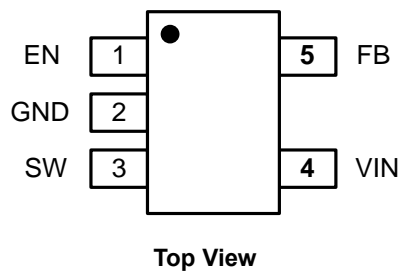

**Pin Description**

Pin No.	Symbol	Description
1	EN	Regulator Enable Control Input with accurate 1.21V enable threshold which can be used to build precision R-C turn-on delay and input under-voltage lockout. This pin has a pull-down resistor of typically 1MΩ to GND. <ul style="list-style-type: none"> <li>• Drive EN above 1.21V to turn on the converter</li> <li>• Drive EN below 1.11V to turn off the converter and discharge output</li> </ul>
2	GND	Ground.
3	SW	Power Switch Node
4	VIN	Input Supply Voltage.
5	FB	Voltage Feedback Input. Connect a resistor divider between output And FB to program the output voltage. VFB is regulated to 0.6V.

**5V Input 1.5A/2A(Peak) 2.5MHz Synchronous Step-Down Converter**
**Absolute Maximum Rating (Reference to GND) (Note1)**

$V_{IN}$ .....	-0.3V to +6.5V	Junction Temperature Range .....	-40°C to +150°C
$V_{SW}$ .....	-0.3V to $V_{IN} + 0.3V$	Storage Temperature Range .....	-65°C to +150°C
Dynamic $V_{SW}$ in 10ns Duration .....	-2V to $V_{IN} + 2V$	ESD .....	Class 2
The other Pins .....	-0.3V to +6.5V	Lead Temperature( Soldering 10s) .....	260°C

**Recommend Operating Conditions (Note2)**

Input Voltage ( $V_{BAT}$ ) .....	+2.5V to +6V	Operating Temperature Range .....	-40°C to +85°C
Output Voltage ( $V_{OUT}$ ) .....	+0.6V to $V_{IN}$		

**Thermal information (Note3, 4)**

Maximum Power Dissipation( $T_A=25^\circ\text{C}$ )		Thermal Resistance( $\theta_{JA}$ ) .....	210°C/W
SOT23_5L.....	0.48W	Thermal Resistance( $\theta_{JC}$ ) .....	100°C/W

Note (1): Stress exceeding those listed “Absolute Maximum Ratings” may damage the device.

Note (2): The device is not guaranteed to function outside of the recommended operating conditions.

Note (3): Measured on JESD51-7, 4-Layer PCB.

Note (4): The maximum allowable power dissipation is a function of the maximum junction temperature  $T_{J\_MAX}$ , the junction to ambient thermal resistance  $\theta_{JA}$ , and the ambient temperature  $T_A$ . The maximum allowable continuous power dissipation at any ambient temperature is calculated by  $P_{D\_MAX} = (T_{J\_MAX} - T_A) / \theta_{JA}$ . Exceeding the maximum allowable power dissipation will cause excessive die temperature, and the regulator will go into thermal shutdown. Internal thermal shutdown circuitry protects the device from permanent damage.

**Electrical Characteristics**

$T_A = 25^\circ\text{C}$ ,  $V_{IN}=5V$ , unless otherwise noted. Typical values are at  $V_{IN} = V_{EN} = 5V$  and  $V_{OUT} = 1.8V$ .

PARAMETER	TEST CONDITIONS	MIN	TYP	MAX	UNIT
Input Voltage Range $V_{IN}$		2.5		6.0	V
Shutdown Current	$V_{EN} = 0V$ , $V_{IN} = 5.5V$		0.1	1	$\mu\text{A}$
Input Under Voltage Lockout Threshold	$V_{IN}$ Increasing	2.3	2.4	2.5	V
Input Under Voltage Lockout Hysteresis			280		mV
Input Over Voltage Lockout Threshold		6.4	6.6	6.8	V
Input Over Voltage Lockout Hysteresis			400		mV
Quiescent Current $I_Q$	$V_{FB} = 0.63V$		15	20	$\mu\text{A}$
Feedback Voltage $V_{FB}$		593	600	607	mV
Feedback Current $I_{FB}$			1		nA
HS Switch Peak Current Limit		2.8	3.5	4.2	A
HS Main Switch On Resistance	$V_{IN}=5V$		260		$\text{m}\Omega$
LS Synchronous Switch On Resistance	$V_{IN}=5V$		180		$\text{m}\Omega$
HS Leakage Current	$V_{IN} = 5.5V$ , $V_{EN} = V_{SW} = 0V$		0.1	2	$\mu\text{A}$
LS Leakage Current	$V_{IN} = V_{SW} = 5.5V$ , $V_{EN} = 0V$		0.1	2	$\mu\text{A}$

5V Input 1.5A/2A(Peak) 2.5MHz Synchronous Step-Down Converter

PARAMETER	TEST CONDITIONS	MIN	TYP	MAX	UNIT
PWM Switching Frequency	$I_{OUT} = 1A$		2.5		MHz
EN On Threshold	$V_{EN}$ ramp up	1.18	1.21	1.24	V
EN Off Threshold	$V_{EN}$ ramp down	1.05	1.11	1.17	
EN Internal Pull Down Resistor		700	1000	1300	k $\Omega$
Thermal Shutdown			160		$^{\circ}C$
Thermal Shutdown Hysteresis			30		$^{\circ}C$
Output Discharging Resister	$V_{EN} = 0V, V_{SW} = 1V$		200		$\Omega$

Functional Block Diagram

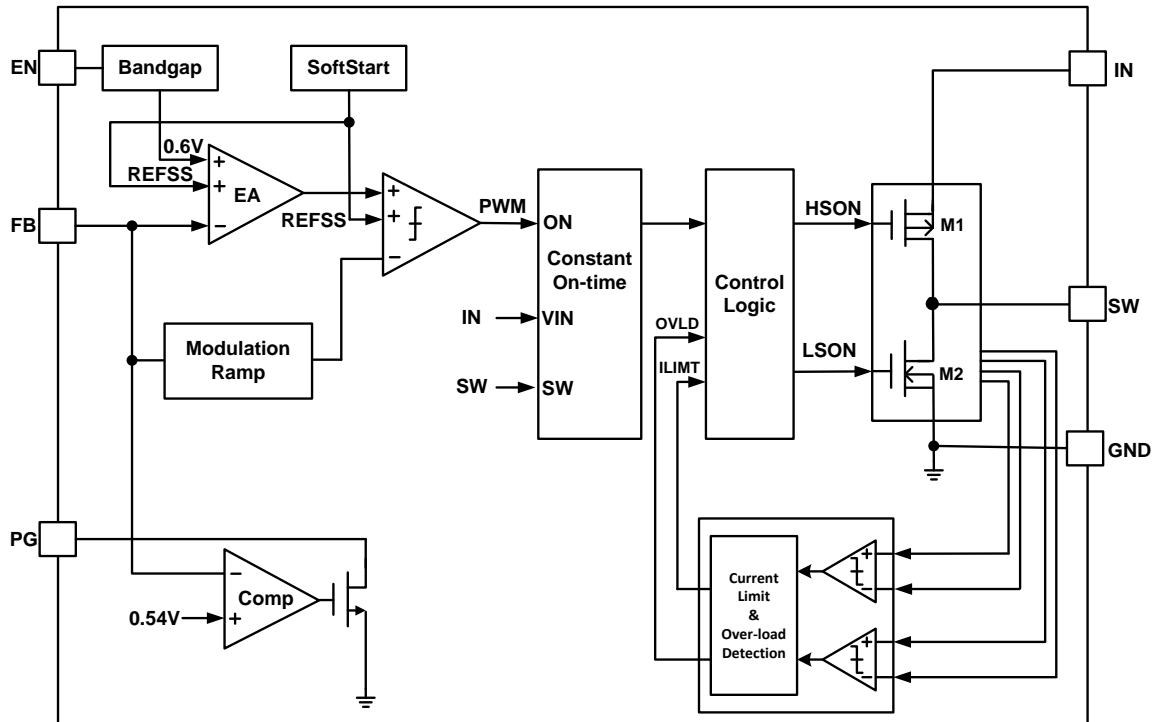

5V Input 1.5A/2A(Peak) 2.5MHz Synchronous Step-Down Converter

TYPICAL PERFORMANCE CHARACTERISTICS

C<sub>IN</sub>=10uF, C<sub>OUT</sub>=10uF, L=0.47uH, T<sub>A</sub>=+25°C

Steady State Test

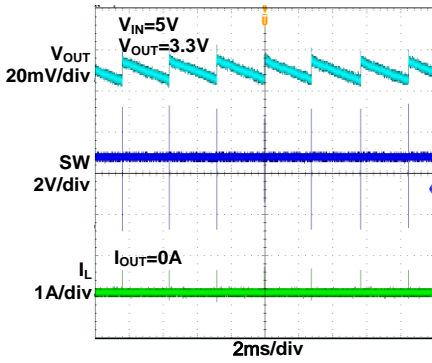

Steady State Test

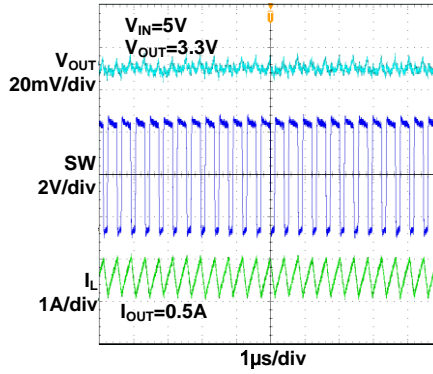

Steady State Test

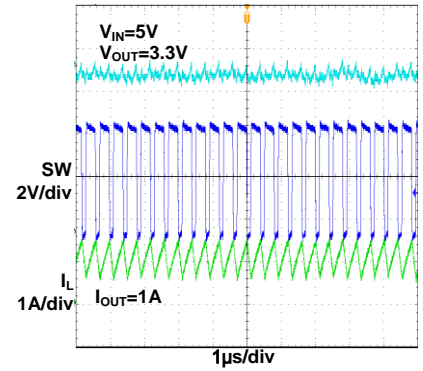

Steady State Test

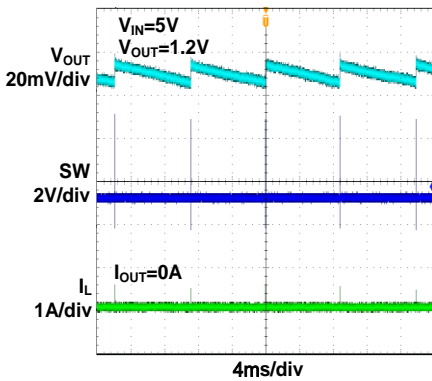

Steady State Test

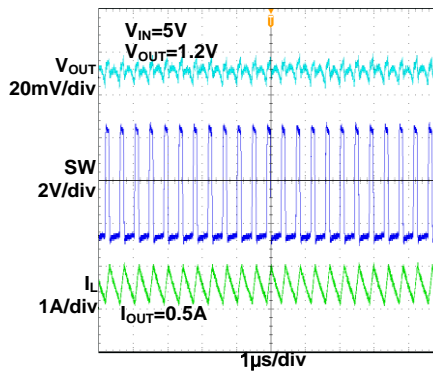

Steady State Test

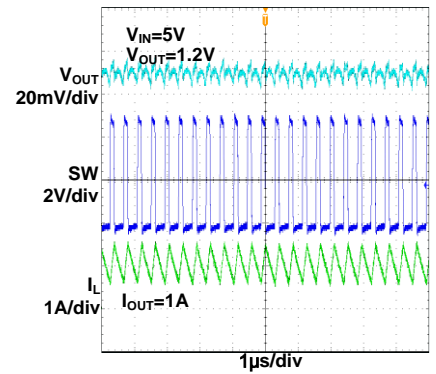

Load Transient Response

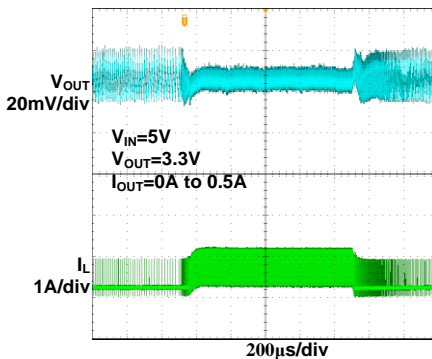

Load Transient Response

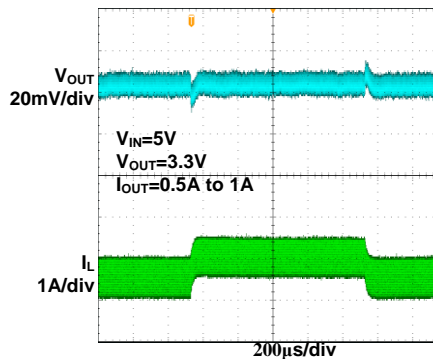

Load Transient Response

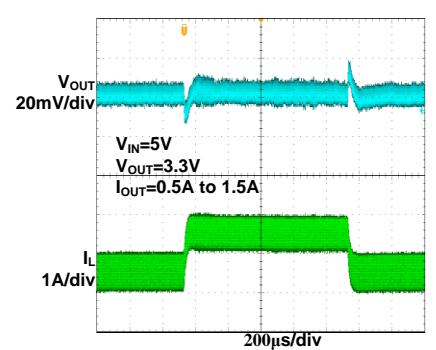

5V Input 1.5A/2A(Peak) 2.5MHz Synchronous Step-Down Converter

TYPICAL PERFORMANCE CHARACTERISTICS

C<sub>IN</sub>=10uF, C<sub>OUT</sub>=10uF, L=0.47uH, T<sub>A</sub>=+25°C

Load Transient Response

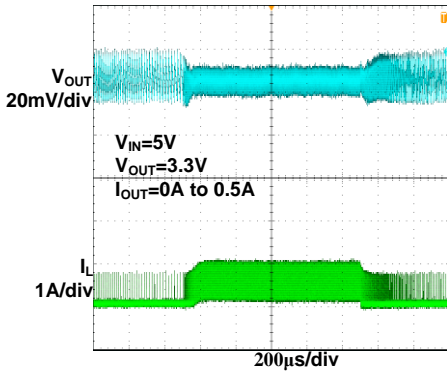

Load Transient Response

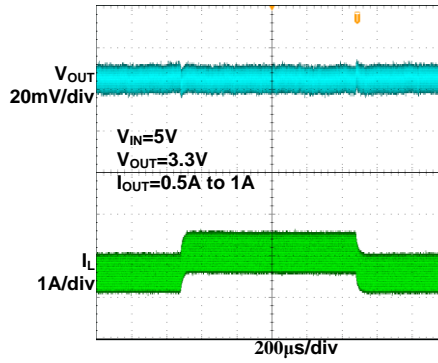

Load Transient Response

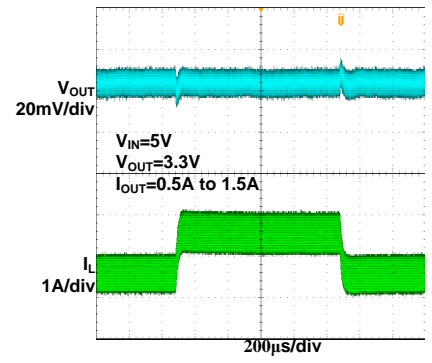

Vin Power On

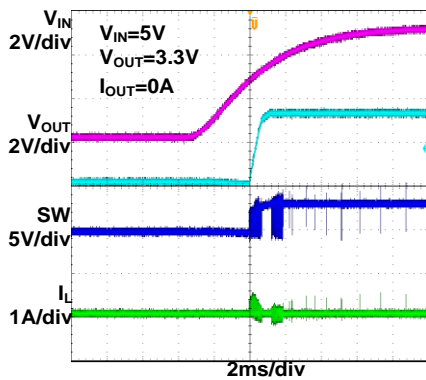

Vin Power Off

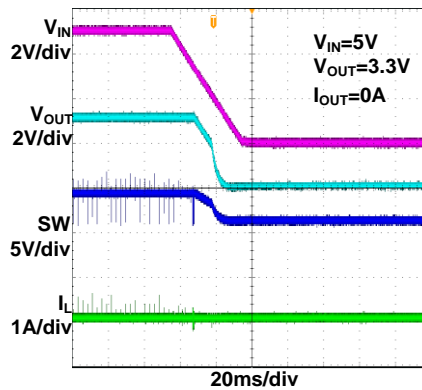

Vin Power On

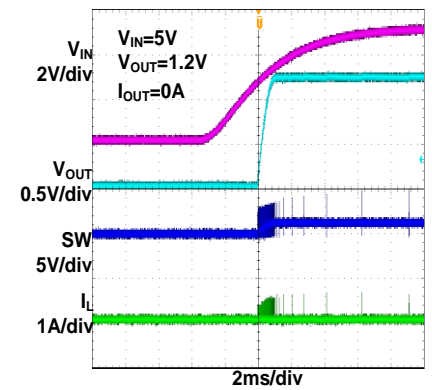

Vin Power On

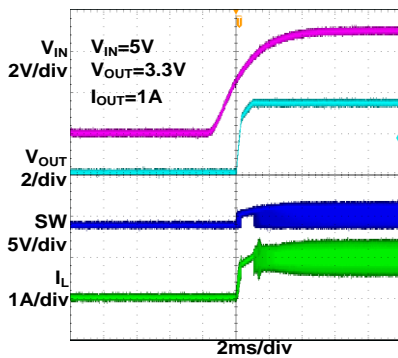

Vin Power Off

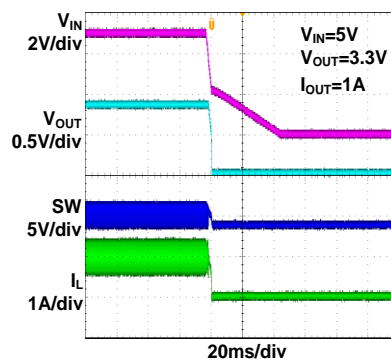

Vin Power Off

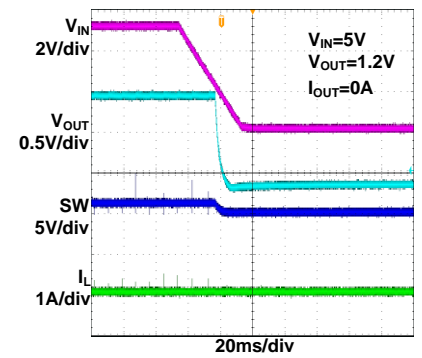

5V Input 1.5A/2A(Peak) 2.5MHz Synchronous Step-Down Converter

TYPICAL PERFORMANCE CHARACTERISTICS

C<sub>IN</sub>=10uF, C<sub>OUT</sub>=10uF, L=0.47uH, TA=+25°C

V<sub>in</sub> Power On

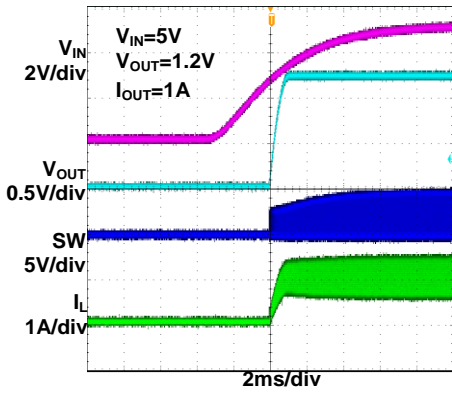

V<sub>in</sub> Power Off

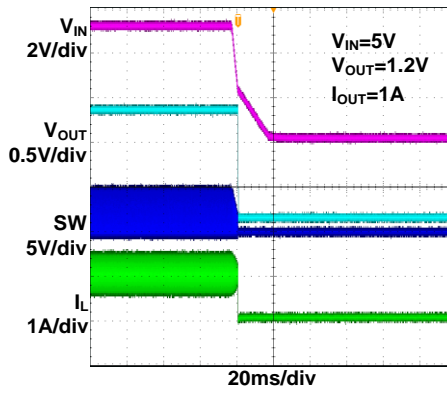

Efficiency (%)

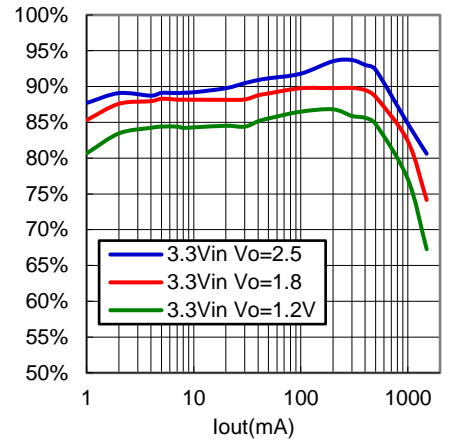

EN On

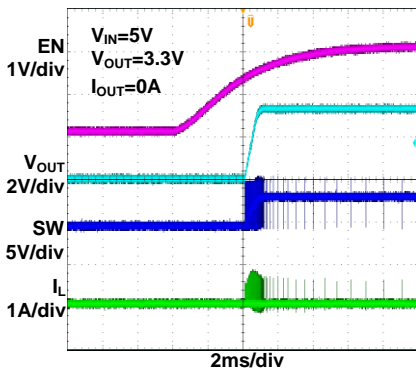

EN Off

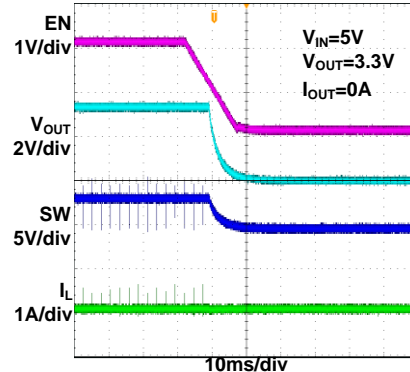

EN On

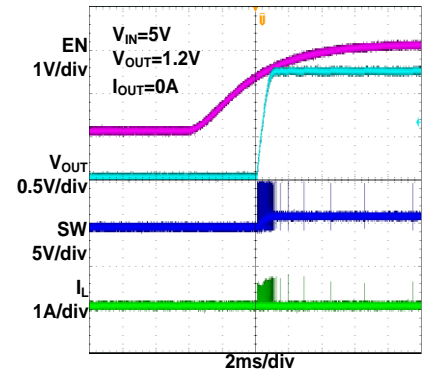

EN On

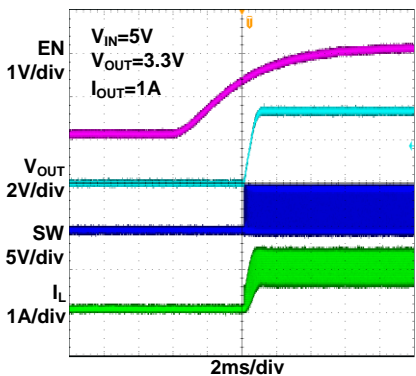

EN Off

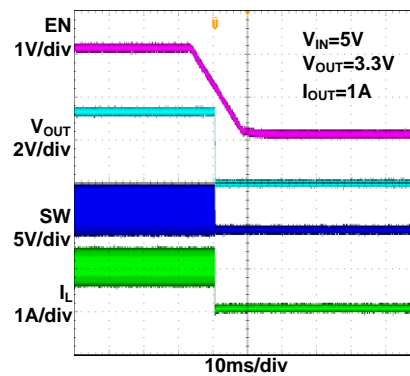

EN Off

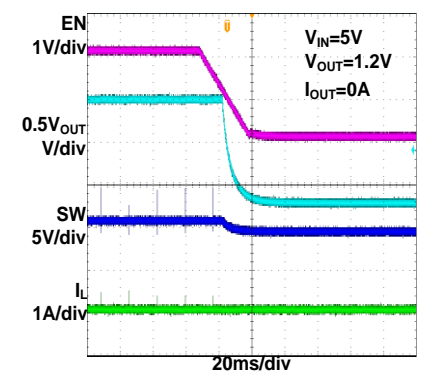

5V Input 1.5A/2A(Peak) 2.5MHz Synchronous Step-Down Converter

TYPICAL PERFORMANCE CHARACTERISTICS

C<sub>IN</sub>=10uF, C<sub>OUT</sub>=10uF, L=1uH, T<sub>A</sub>=+25°C

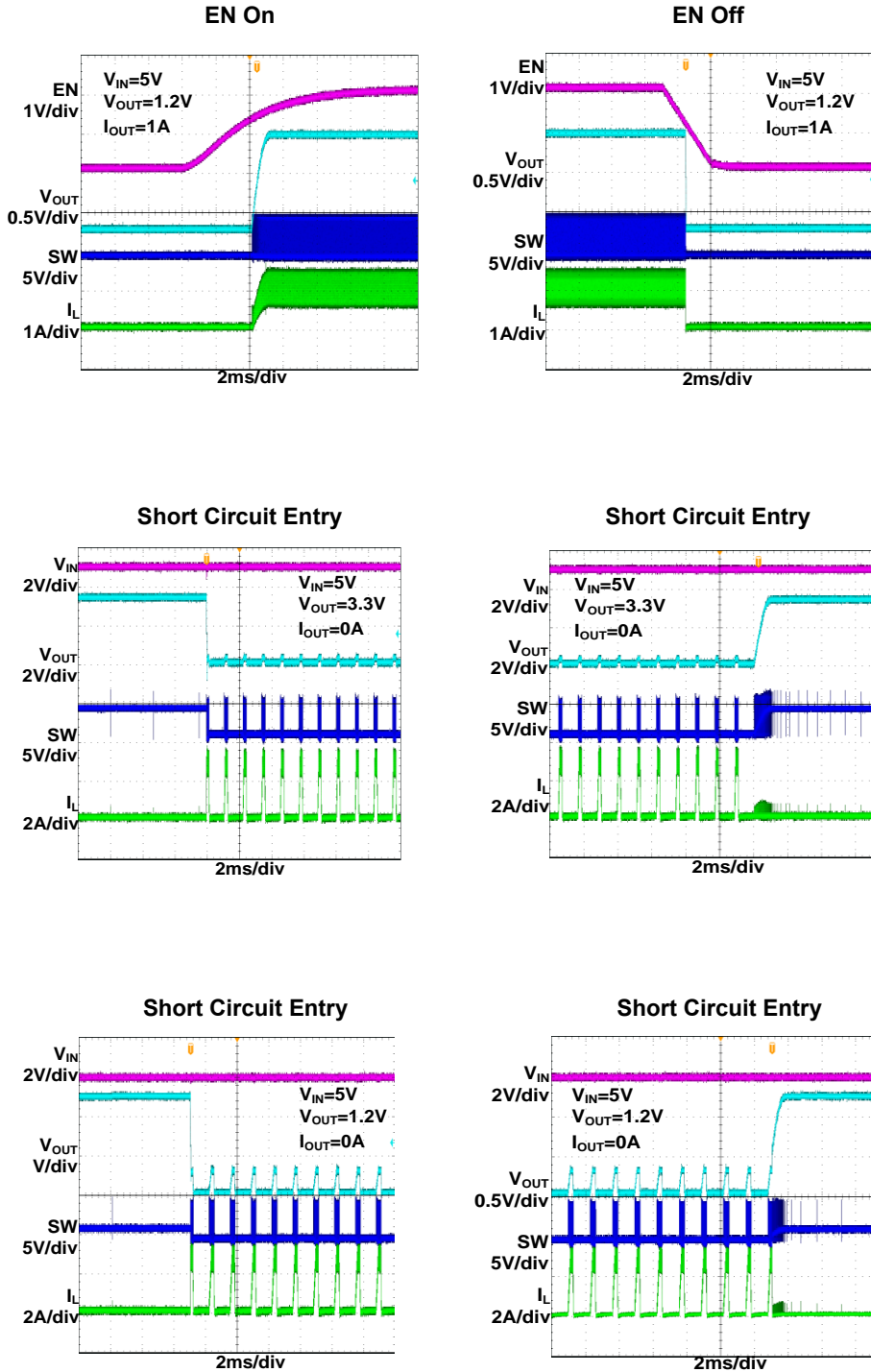



**5V Input 1.5A/2A(Peak) 2.5MHz Synchronous Step-Down Converter**

---

**Theory of Operation**

MT83121 is a constant on-time control synchronous step-down converter that offers excellent transient response over a wide range of input voltage. It achieves superior light-load efficiency with extremely low quiescent current.

**Constant On-time Control**

Constant on-time control step-down converters turn on HS immediately when FB droops below reference. The HS is turned on for a pre-determined period (on-time) of time to ramp up the inductor current, and then the LS will be turned on to ramp down the inductor current. The cycle repeats itself if FB droops below reference again. MT83121 uses proprietary technique to take into account the load current impact and adjusts the on-time accordingly to achieve a constant switching frequency over entire load current range.

For MT83121, the on-time is approximately:

$$T_{ON} = \frac{V_{OUT}}{V_{IN}} \cdot 0.4\mu$$

Due to its immediate response on FB voltage droop and simplified loop compensation, constant on-time offers a superior transient response compare to traditional fixed frequency PWM control step-down converters.

**Light Load Operation**

In light load condition where the converter operates in discontinuous mode, MT83121 cuts down its quiescent current to as low as 15uA and achieves excellent light load efficiency.

**Enable**

When input voltage is above the under voltage lock-out threshold, MT83121 can be enabled by pulling the EN pin to above 1.21V. MT83121 is disabled if the EN pin is pulled below 1.1V. The enable/disable threshold for EN pin is accurately designed to be 1.21V and 1.11V respectively, so one can also use external resistor divider to program the desired input under-voltage lockout level.

**Soft Start**

MT83121 has built-in soft start of 1ms. During the soft start period, output voltage is ramped up linearly to the regulation voltage, independent of the load current level and output capacitor value.

**Current Limit and Hiccup Mode**

MT83121 has cycle-by-cycle HS current limit protection to prevent inductor current from running away. Once HS current limit is triggered, MT83121 will turn on LS and wait for the inductor to drop down to a pre-determined level before the HS can be turned on again. If this current limit condition is repeated for a sustained long period of time, MT83121 will consider it over-load or short circuit. Either way, MT83121 will enter hiccup mode, where it stop switching for a pre-determined period of time before automatically re-try to start up again. It always starts up with soft-start to limit inrush current and avoid output overshoot.

**5V Input 1.5A/2A(Peak) 2.5MHz Synchronous Step-Down Converter****Application Information****Setting the Output Voltage**

External feedback resistors are used to set the output voltage. Refer to typical application circuit on page1, the top feedback resistor R1 has some impact on the loop stability, so its recommended range is between 100kΩ-300kΩ. For any chosen R1, the bottom feedback resistor R2 can be calculated as:

$$R_2 = \frac{R_1}{\frac{V_{OUT}}{0.6} - 1}$$

**Inductor Selection**

The recommended inductor value for MT83121 is between 0.33μH to 1μH. Usually the inductor value is chosen to satisfy a desired ripple current:

$$L = \frac{V_{OUT} \cdot (V_{IN} - V_{OUT})}{V_{IN} \cdot f_{SW} \cdot \Delta I}$$

where  $\Delta I$  is the inductor ripple current.

With the chosen  $\Delta I$ , the peak inductor current will be:

$$I_{PK} = I_{LOAD} + \frac{1}{2} \cdot \Delta I$$

**Input Bypass Capacitor Selection**

The input current to the step-down converter is discontinuous with very sharp edges, therefore an input bypass capacitor is required. For best performance, it's recommended to use low ESR ceramic capacitors and place them as close to the input pin as possible. For lowest temperature variations, use X5R or X7R dielectric ceramic capacitors.

The RMS current of the input capacitor is approximately:

$$I_{CIN\_RMS} = I_{OUT} \sqrt{D(1-D)}$$

From the equation, it can be seen that the highest RMS current occurs when D is 0.5:

$$I_{CIN\_RMS} = \frac{1}{2} I_{OUT}$$

Choose the capacitor with RMS current rating higher than  $1/2 I_{OUT}$

The power dissipation on the input capacitor can be estimated with the RMS current and the ESR resistor.

Electrolytic or tantalum capacitors can also be used, but due to their significantly higher ESR, a small size ceramic capacitor should be placed as close to the IC as possible.

The voltage ripple on the input capacitor, neglecting the ESR impact, can be calculated as:

$$\Delta V_{CIN} = \frac{I_{LOAD}}{f_{SW} \cdot C_{IN}} \cdot \frac{V_{OUT}}{V_{IN}} \cdot \left(1 - \frac{V_{OUT}}{V_{IN}}\right)$$

**Output Capacitor Selection**

An output capacitor is required to obtain a stable output voltage. To minimize the output voltage ripple, ceramic capacitors should be used, and the ripple voltage can be estimated as:

$$\Delta V_{OUT} = \frac{1}{8} \cdot \left(1 - \frac{V_{OUT}}{V_{IN}}\right) \cdot \frac{V_{OUT}}{L} \cdot \frac{1}{(f_{SW})^2 \cdot C_{OUT}}$$

If electrolytic or tantalum capacitors are used, the ESR will dominate the output voltage ripple:

$$\Delta V_{OUT} = \left(1 - \frac{V_{OUT}}{V_{IN}}\right) \cdot \frac{V_{OUT}}{f_{SW} \cdot L} \cdot R_{ESR}$$

**5V Input 1.5A/2A(Peak) 2.5MHz Synchronous Step-Down Converter**

**PCB Layout Recommendation**

The physical design of the PCB is the final stage in the design of power converter. If designed improperly, the PCB could radiate excessive EMI and contribute instability to the power converter. Therefore, following the PCB layout guidelines below can ensure better performance of MT83121.

- (1). The loop (Vin-SW-L-Cout-GND) indicates a high current path. The traces within the loop should be kept as wide and short as possible to reduce parasitic inductance and high-frequency loop area. It is also good for efficiency improvement.
- (2). Input capacitor as close as possible to the IC Pins (Vin and GND) and the input loop area should be as small as possible to reduce parasitic inductance, input voltage spike and noise emission.
- (3). Feedback components (R<sub>1</sub>, R<sub>2</sub> and C<sub>FF</sub>) should be routed as far away from the inductor and the SW Pin as possible to minimize noise and EMI issue.

**MT83121 Application Schematic**

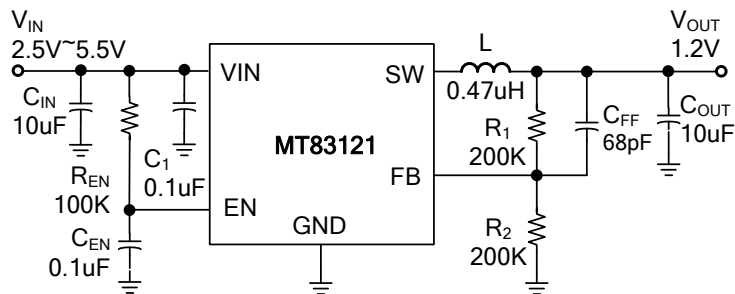

**EVB BOM List**

Qty	Ref	Value	Description	Package	
1	C <sub>IN</sub>	10μF	Ceramic Capacitor, 10V, X5R	0805	
1	C <sub>OUT</sub>	10μF	Ceramic Capacitor, 10V, X5R	0805	
2	C <sub>1</sub> , C <sub>EN</sub>	0.1μF	Ceramic Capacitor, 10V, X5R	0603	
1	C <sub>FF</sub>	68pF	Ceramic Capacitor, 10V, X5R	0603	
1	L	0.47uH	Inductor, MHC106030-R47M, 5.5mΩ, 16.5A	0805 SMD	
1	R <sub>1</sub>	Vout=3.3V	200KΩ	Resistor, ±1%	0603
		Vout=2.5V	240KΩ		
		Vout=1.8V	200KΩ		
		Vout=1.2V	200KΩ		
		Vout=1.0V	100KΩ		
1	R <sub>2</sub>	Vout=3.3V	43KΩ	Resistor, ±1%	0603
		Vout=2.5V	75KΩ		
		Vout=1.8V	100KΩ		
		Vout=1.2V	200KΩ		
		Vout=1.0V	150KΩ		
2	R <sub>EN</sub>	100KΩ	Resistor, ±1%	0603	
1	Power IC	MT83121	Step-Down DC/DC Converter	SOT235	

**5V Input 1.5A/2A(Peak) 2.5MHz Synchronous Step-Down Converter**

**EVB Layout**

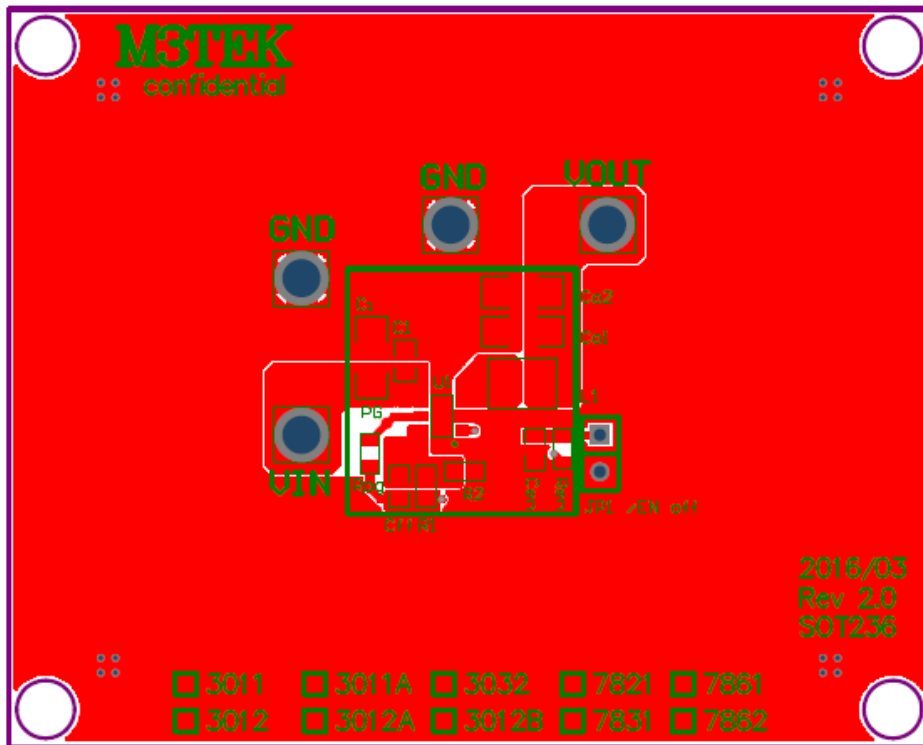

**Top Layer**

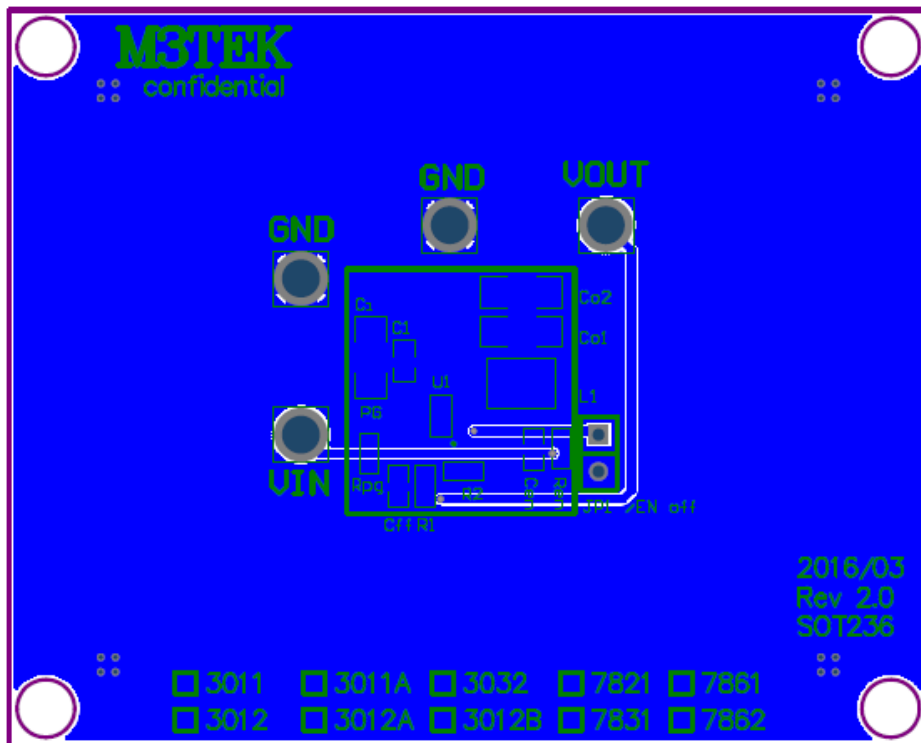

**Bottom Layer**

**5V Input 1.5A/2A(Peak) 2.5MHz Synchronous Step-Down Converter**

**Package Information**

**SOT23\_5L Outline Dimensions**

Unit: inches/mm

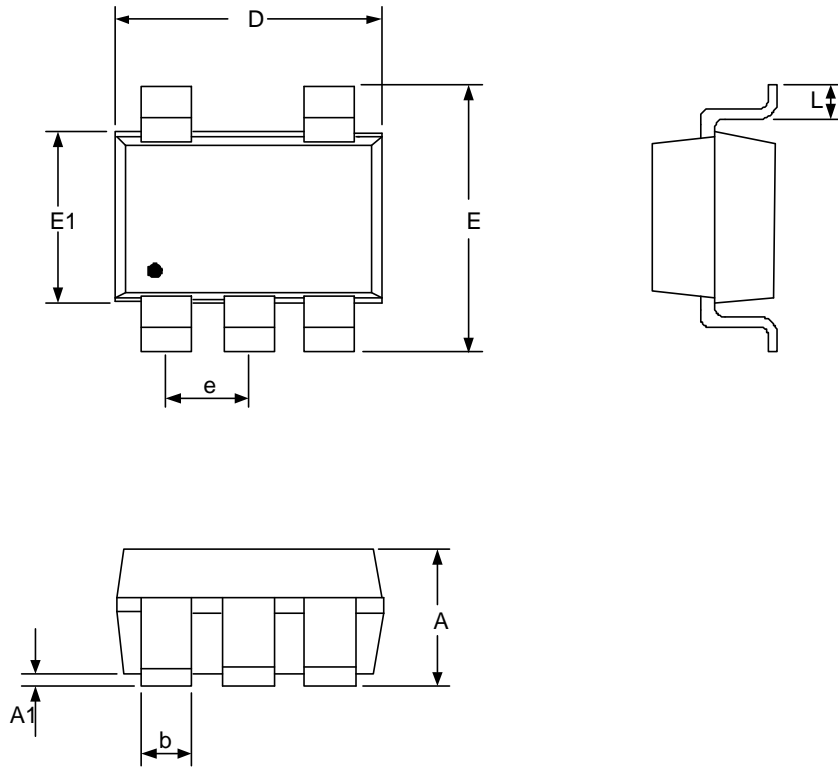

SYMBOLS	MILLIMETERS		INCHES	
	MIN.	MAX.	MIN.	MAX.
A	0.89	1.45	0.035	0.057
A1	0.00	0.15	0.000	0.006
b	0.30	0.50	0.012	0.020
D	2.70	3.10	0.106	0.122
E1	1.40	1.80	0.055	0.071
e	0.84	1.04	0.033	0.041
E	2.60	3.00	0.102	0.118
L	0.30	0.60	0.012	0.024

**5V Input 1.5A/2A(Peak) 2.5MHz Synchronous Step-Down Converter**

**Tape & Reel Carrier Dimensions**

**1. Orientation / Carrier Tape Information :**

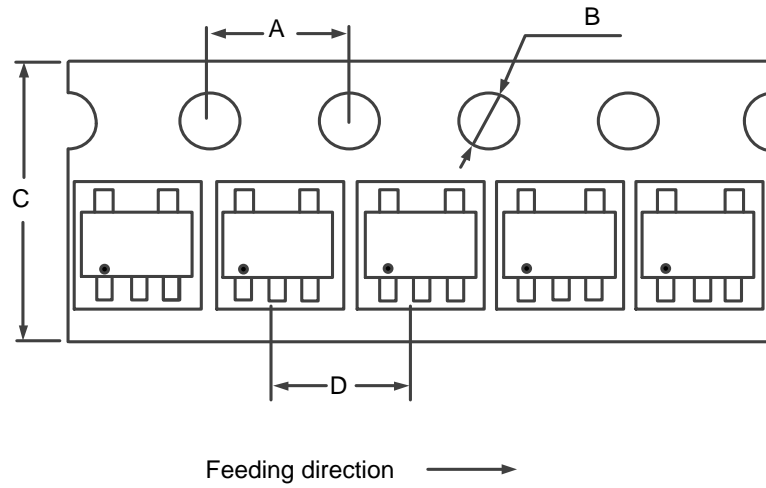

**2. Rokreel Information :**

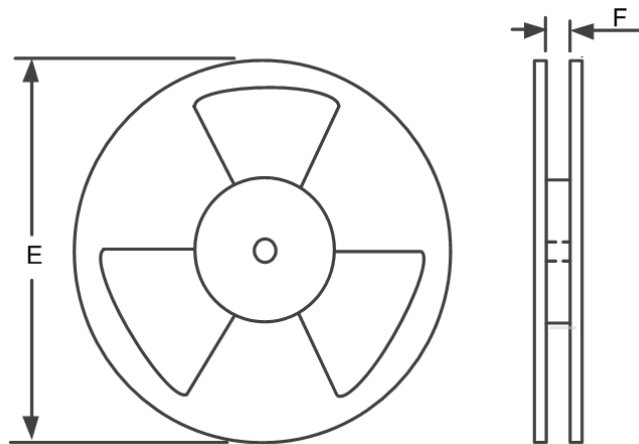

**3. Dimension Details :**

PKG Type	A	B	C	D	E	F	Q'ty/Reel
SOT23_5L	4.0 mm	1.5 mm	8.0 mm	4.0 mm	7 inches	9.0 mm	3,000

**5V Input 1.5A/2A(Peak) 2.5MHz Synchronous Step-Down Converter**

**Reflow Profile**

**Classification Of IR Reflow Profile**

Reflow Profile	Green Assembly
Average Ramp-Up Rate ( $T_{s_{min}}$ to $T_p$ )	1~2°C/second, 3°C/second max.
Preheat & Soak	
-Temperature Min( $T_{s_{min}}$ )	150°C
-Temperature Max( $T_{s_{max}}$ )	200°C
-Time( $t_{s_{min}}$ to $t_{s_{max}}$ )	60~120 seconds
Time maintained above:	
-Temperature( $T_L$ )	217°C
-Time( $t_L$ )	60~150 seconds
Peak Temperature( $T_p$ )	See Classification Temp in table 1
Time within 5°C of actual Peak Temperature( $t_p$ )	30 seconds max.
Ramp-Down Rate	6°C/second max.
Time 25°C to Peak Temperature	8 minutes max.

\* Tolerance for peak profile Temperature ( $T_p$ ) is defined as a supplier minimum and a user maximum.

\*\* Tolerance for time at peak profile temperature ( $t_p$ ) is defined as a supplier minimum and a user maximum.

Table 1. Pb-free Process – Classification Temperatures ( $T_c$ )

Package Thickness	Volume mm <sup>3</sup> <350	Volume mm <sup>3</sup> 350-2000	Volume mm <sup>3</sup> >2000
<1.6 mm	260 °C	260 °C	260 °C
1.6 mm – 2.5 mm	260 °C	250 °C	245 °C
2.5 mm	250 °C	245 °C	245 °C

**Note:** For all temperature information, please refer to topside of the package, measured on the package body surface.

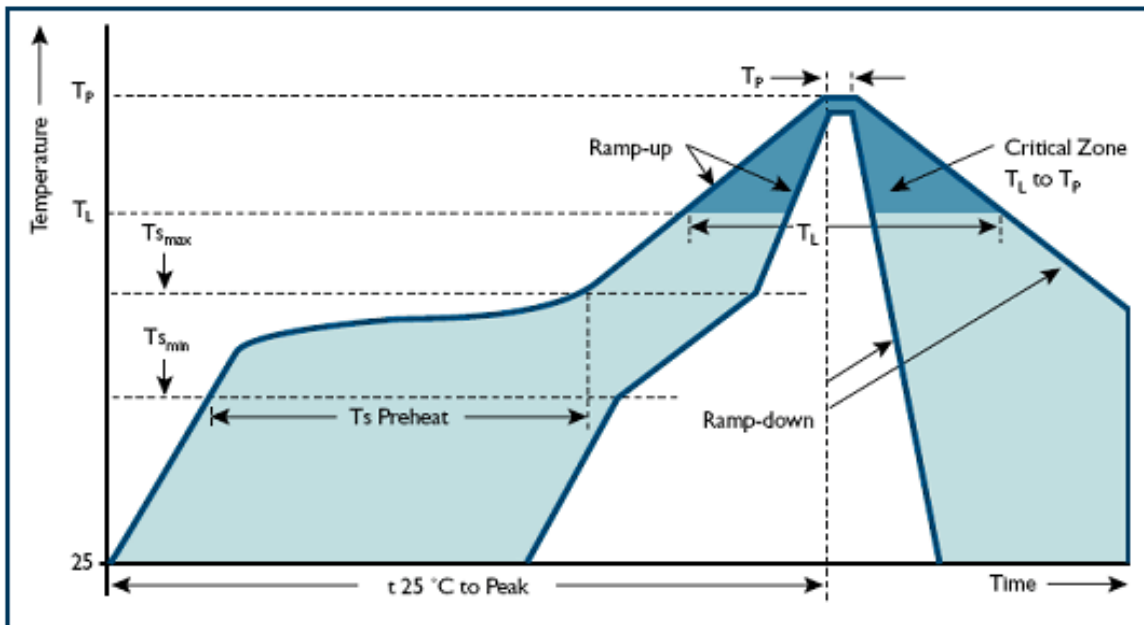

## X-ON Electronics

Largest Supplier of Electrical and Electronic Components

*Click to view similar products for [Switching Controllers](#) category:*

*Click to view products by [M3Tek](#) manufacturer:*

Other Similar products are found below :

[LV5065VB-TLM-H](#) [LV5066V-TLM-H](#) [LV5725JAZ-AH](#) [633888R](#) [MP2908AGF](#) [AZ7500EP-E1](#) [NCP1012AP133G](#) [NCP1217P133G](#)  
[NCP1218AD65R2G](#) [NCP1234AD100R2G](#) [NCP1244BD065R2G](#) [NCP1336ADR2G](#) [NCP1587GDR2G](#) [NCP6153MNTWG](#)  
[NCP81005MNTWG](#) [NCP81101BMNTXG](#) [NCP81205MNTXG](#) [HV9123NG-G-M934](#) [IR35207MTRPBF](#) [ISL6367HIRZ](#) [CAT874-80ULGT3](#)  
[SJ6522AG](#) [SJE6600](#) [TLE63893GV50XUMA1](#) [IR35215MTRPBF](#) [SG3845DM](#) [NCP1216P133G](#) [NCP1236DD65R2G](#) [NCP1247BD100R2G](#)  
[NCP1250BP65G](#) [NCP4202MNR2G](#) [NCP4204MNTXG](#) [NCP6132AMNR2G](#) [NCP81141MNTXG](#) [NCP81142MNTXG](#) [NCP81172MNTXG](#)  
[NCP81203MNTXG](#) [NCP81206MNTXG](#) [NX2155HCUPTR](#) [UC3845ADM](#) [UBA2051C](#) [IR35201MTRPBF](#) [MAX8778ETJ+](#)  
[MAX17500AAUB+T](#) [MAX17411GTM+T](#) [MAX16933ATIR/V+](#) [NCP1010AP130G](#) [NCP1063AD100R2G](#) [NCP1216AP133G](#)  
[NCP1217AP100G](#)