

Features

- 1.9 dB Typical Midband Noise Figure
- +7 dBm Typical Midband Output Power
- +20 dBm Typical Third Order Intercept

Description

M/A-COM's AM-143 is a coupler feedback amplifier with low noise figure and high intercept points for the low bias current. The use of coupler feedback minimizes noise figure and current in a high intercept amplifier. This amplifier is packaged in a TO-8 package. The ground plane on the PC board should be configured to remove heat from under the package. AM-143 are ideally suited for use where a low noise, high reliability amplifier is required.

Ordering Information

Part Number	Package
AM-143 PIN ³	TO-8-1
AMC-143 SMA	Connectorized

3. Mounting kit part number AU00071 required for PCB applications.

Absolute Maximum Ratings¹

Parameter	Absolute Maximum
Max. Input Power	+20 dBm
V _{bias}	+15.75 V
Operating Temperature	-55°C to +85°C
Storage Temperature	-65°C to +125°C

1. Operation of this device above any one of these parameters may cause permanent damage.

TO-8-1

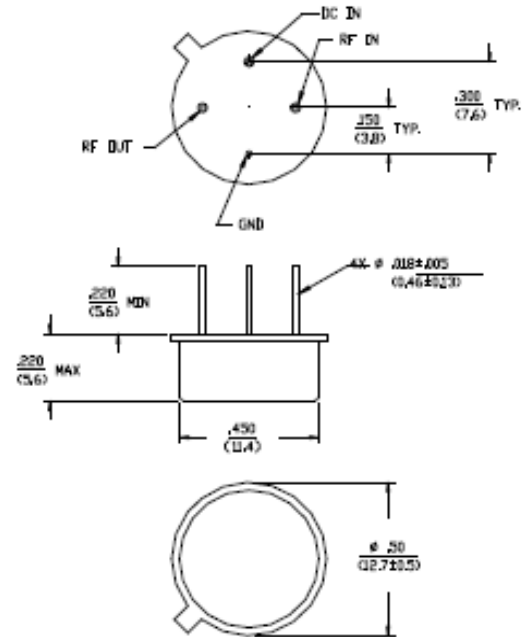

Dimensions in \varnothing are in mm
Unless Otherwise Noted .XXX = ± 0.001 (.XXX = ± 0.025)
.XX = ± 0.02 (.XX = ± 0.5)
WEIGHT (APPROX) (G) OUNCES 2.8 GRAMS

Outline Drawing: SMA Connectorized^{*}

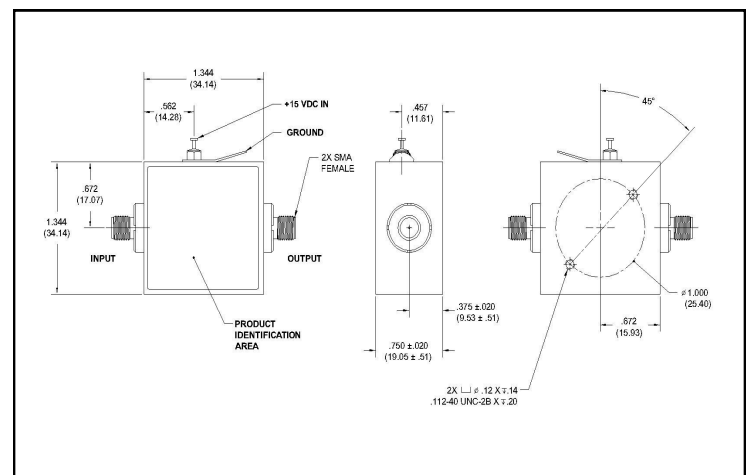

* Dimensions are inches (millimeters) ± 0.015 (0.38) unless otherwise specified.

Electrical Specifications: ², T_A = -55°C to +85°C Case Temperature

Parameter	Test Conditions	Frequency	Units	Min.	Typ.	Max.
Gain	@+25°C	50 MHz	dB	15.3	15.8	16.3
Frequency Response	—	5 - 500 MHz	dB	—	—	±1.0
Gain Variation with Temperature	—	5 - 500 MHz	dB	—	—	±0.8
1 dB Compression	Output Power	5 - 500 MHz	dBm	+4	—	—
Noise Figure	—	5 - 500 MHz 5 - 100 MHz	dB	— —	— —	3.5 2.7
Reverse Transmission	—	5 - 500 MHz	dB	—	-21	-16
VSWR	—	5 - 500 MHz	Ratio	—	—	2.5:1
Output IP ₂	Two-Tone inputs up to -10 dBm	5 - 500 MHz	dBm	+24	—	—
Output IP ₃	Two-Tone inputs up to -10 dBm	5 - 500 MHz	dBm	+16	—	—
Vbias	—	—	VDC	+14.5	+15.0	+15.5
Ibias	Vbias = +15.0 VDC	—	mA	—	13	15
Power Dissipation	@ +15 V Bias	—	mW	—	200	—

2. All specifications apply when operated at +15 VDC, with 50 ohms source and load impedance.

S-Parameter Data

Frequency (MHz)	S11 MAG/ANG	S21 MAG/ANG	S12 MAG/ANG	S22 MAG/ANG
5	0.20/-60.7	5.90/-161.0	0.09/-160.5	0.32/-24.9
10	0.12/-63.8	6.07/-171.8	0.09/-172.6	0.27/-24.9
20	0.09/-65.3	6.16/-179.8	0.10/178.9	0.26/-17.4
50	0.10/-82.7	6.08/167.5	0.10/166.3	0.25/-28.0
100	0.14/-101.0	6.06/153.3	0.10/150.5	0.26/-49.3
200	0.21/-130.6	6.00/126.7	0.10/119.8	0.26/-82.3
300	0.23/-149.2	6.01/100.9	0.10/93.6	0.24/-104.5
400	0.20/-155.5	6.09/70.7	0.10/67.4	0.22/-100.5
500	0.22/-142.9	6.11/36.8	0.10/43.3	0.20/-79.8

2

Typical Performance Curves

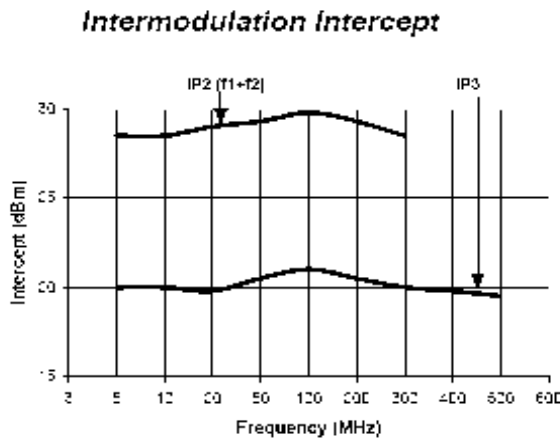
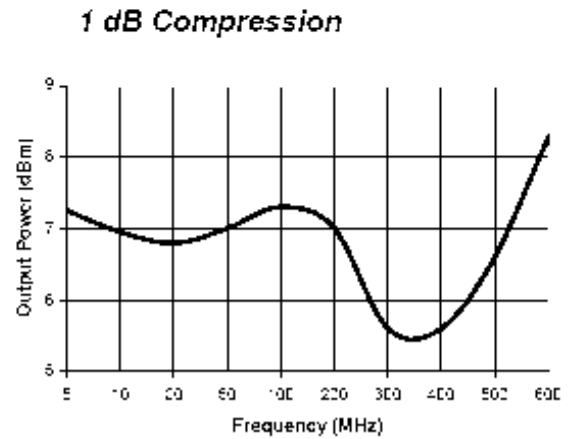
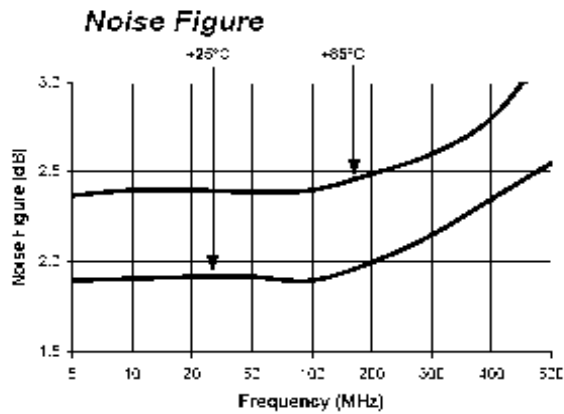
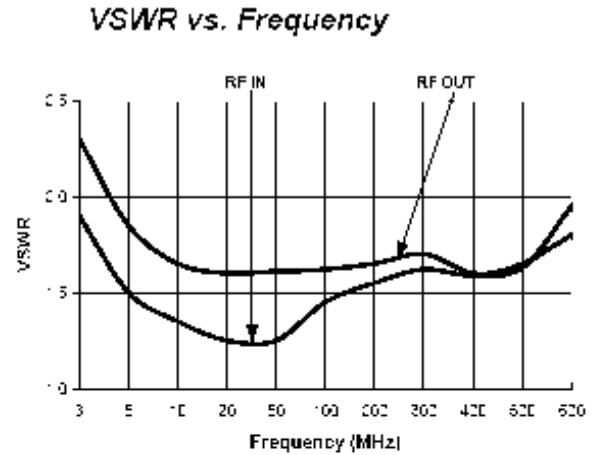
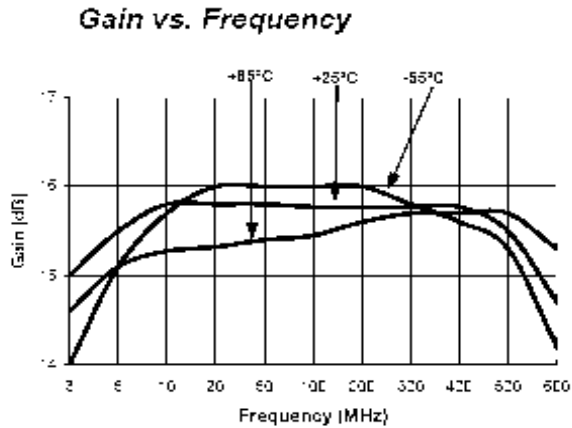

M/A-COM Technology Solutions Inc. All rights reserved.

Information in this document is provided in connection with M/A-COM Technology Solutions Inc ("MACOM") products. These materials are provided by MACOM as a service to its customers and may be used for informational purposes only. Except as provided in MACOM's Terms and Conditions of Sale for such products or in any separate agreement related to this document, MACOM assumes no liability whatsoever. MACOM assumes no responsibility for errors or omissions in these materials. MACOM may make changes to specifications and product descriptions at any time, without notice. MACOM makes no commitment to update the information and shall have no responsibility whatsoever for conflicts or incompatibilities arising from future changes to its specifications and product descriptions. No license, express or implied, by estoppel or otherwise, to any intellectual property rights is granted by this document.

THESE MATERIALS ARE PROVIDED "AS IS" WITHOUT WARRANTY OF ANY KIND, EITHER EXPRESS OR IMPLIED, RELATING TO SALE AND/OR USE OF MACOM PRODUCTS INCLUDING LIABILITY OR WARRANTIES RELATING TO FITNESS FOR A PARTICULAR PURPOSE, CONSEQUENTIAL OR INCIDENTAL DAMAGES, MERCHANTABILITY, OR INFRINGEMENT OF ANY PATENT, COPYRIGHT OR OTHER INTELLECTUAL PROPERTY RIGHT. MACOM FURTHER DOES NOT WARRANT THE ACCURACY OR COMPLETENESS OF THE INFORMATION, TEXT, GRAPHICS OR OTHER ITEMS CONTAINED WITHIN THESE MATERIALS. MACOM SHALL NOT BE LIABLE FOR ANY SPECIAL, INDIRECT, INCIDENTAL, OR CONSEQUENTIAL DAMAGES, INCLUDING WITHOUT LIMITATION, LOST REVENUES OR LOST PROFITS, WHICH MAY RESULT FROM THE USE OF THESE MATERIALS.

MACOM products are not intended for use in medical, lifesaving or life sustaining applications. MACOM customers using or selling MACOM products for use in such applications do so at their own risk and agree to fully indemnify MACOM for any damages resulting from such improper use or sale.

X-ON Electronics

Largest Supplier of Electrical and Electronic Components

Click to view similar products for [RF Amplifier](#) category:

Click to view products by [MACOM](#) manufacturer:

Other Similar products are found below :

[ADPA7006AEHZ](#) [CXE2089ZSR](#) [MGA-43828-BLKG](#) [A82-1](#) [RF2878TR7](#) [BGA 728L7 E6327](#) [BGB719N7ESDE6327XTMA1](#) [HMC1126-SX](#) [HMC342](#) [HMC561-SX](#) [HMC598-SX](#) [HMC-ALH382-SX](#) [HMC-ALH476-SX](#) [SE2433T-R](#) [SE2622L-R](#) [SMA3101-TL-E](#) [SMA39](#) [SMA70-1](#) [A66-1](#) [A66-3](#) [A67-1](#) [LX5535LQ](#) [LX5540LL](#) [RF2373TR7](#) [HMC3653LP3BETR](#) [HMC395](#) [HMC549MS8GETR](#) [HMC576-SX](#) [HMC754S8GETR](#) [HMC-ALH435-SX](#) [SMA101](#) [SMA1031](#) [SMA181](#) [SMA32](#) [SMA411](#) [SMA531](#) [SST12LP17E-XX8E](#) [SST12LP19E-QX6E](#) [TGA2598](#) [WPM0510A](#) [HMC5929LS6TR](#) [HMC5879LS7TR](#) [HMC906A-SX](#) [HMC1127](#) [HMC544A](#) [HMC1126](#) [HMC1110-SX](#) [HMC1087F10](#) [HMC1086](#) [HMC1016](#)