

### Features

- Constant Gamma = 1.0, 1.25 & 1.5
- High Q (up to 4000 at -4 Volts)
- More Linear Frequency Tuning
- High and Nearly Constant Modulation Sensitivity
- Lead-Free (RoHS Compliant) equivalents available with 260°C reflow compatibility

### Description and Applications

The MA46450, MA46470 and MA46410 series of tuning varactors are hyperabrupt junction Gallium Arsenide diodes featuring constant gamma 1.0 (MA46450 series), 1.25 (MA46470 series) & 1.5 (MA46410 series). These diodes offer high Q (up to 4000) permitting excellent tuning performance from VHF through Ka band. Each part in this series exhibits the large change in capacitance versus bias voltage characteristic of hyperabrupt junctions. The standard capacitance tolerance is  $\pm 10\%$ , with tighter tolerances available. Capacitance matching at one or more bias voltages is also available. All diode types are available in a wide selection of ceramic packages and in chip form. The constant gamma value of 1.0, 1.25 & 1.5 available with these diodes enables the circuit designer to produce significant improvements in circuit performance. Constant gamma tuning varactors permit more linear VCO frequency tuning than do conventional hyperabrupt tuning varactors. These varactors are particularly well suited for use in voltage tuned filters, analog phase shifters, and modulator circuits.

### Packaged Tuning Varactor Equivalent Circuit

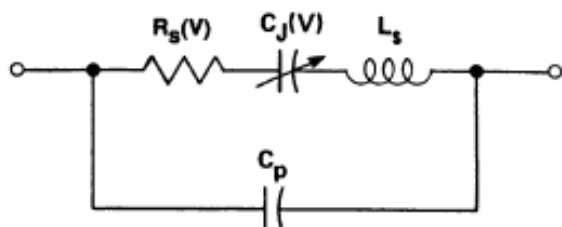

### Common Case Styles

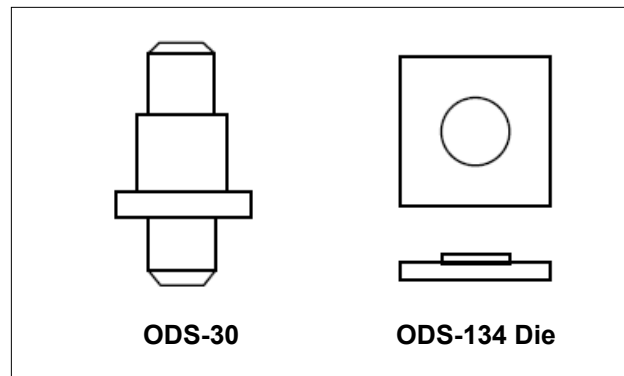

### Absolute Maximum Ratings<sup>1</sup> @ T<sub>A</sub> = +25 °C (Unless Otherwise Noted)

Parameter	Absolute Maximum
Reverse Voltage	Breakdown Voltage
Operating Temperature	-65°C to +175°C
Storage Temperature	65°C to +200°C

1. Operation of this device above any one of these parameters may cause permanent damage. The maximum storage and operating temperature of the plastic ODS-1088 case style is 125°C.

### Typical Junction Capacitance vs. Tuning Voltage

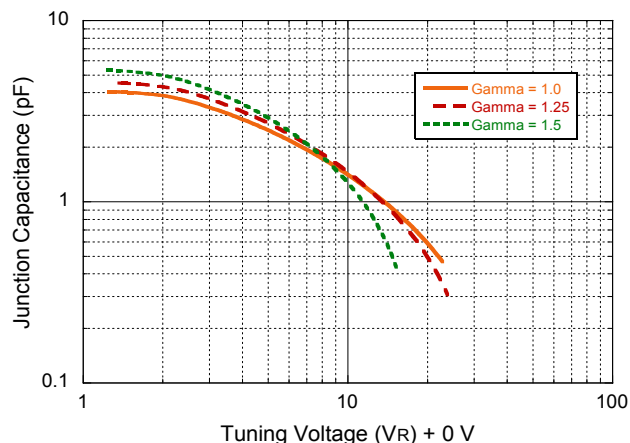

## Electrical Specifications<sup>2</sup>: T<sub>A</sub> = +25°C

### Gamma = 1.0<sup>3</sup> MA46450 Series

Gamma = 0.9 - 1.1, V<sub>R</sub> = 2 - 20 Volts  
 Junction Capacitance Ratio (C<sub>J2</sub>/C<sub>J20</sub>) = 5.0 - 8.0  
 Breakdown Voltage @ I<sub>R</sub> = 10 μA, V<sub>b</sub> = 22 V min.  
 Reverse Leakage Current @ V<sub>R</sub> = 18 V, I<sub>R</sub> = 100 nA max.

Part Number	Total Capacitance +/-10% <sup>4,5,6,7</sup>	Total Capacitance Ratio <sup>7</sup>	Q Minimum
	V <sub>R</sub> = 4 V f = 1 MHz	V <sub>R</sub> = 2 V / 20 V	V <sub>R</sub> = 4 V f = 50 MHz
	(pF)	-	-
MA46450	0.5	2.0-3.8	4000
MA46451	0.7	2.9-4.4	4000
MA46452	1.0	3.6-5.2	3000
MA46457	2.2	4.1-6.1	3000
MA46461	4.7	4.8-7.2	1500

### Gamma = 1.25<sup>3</sup> MA46470 thru MA46485 Series

Gamma = 1.13 - 1.38, V<sub>R</sub> = 2 - 20 Volts  
 Junction Capacitance Ratio (C<sub>J2</sub>/C<sub>J20</sub>) = 8.15 - 12.99  
 Breakdown Voltage @ I<sub>R</sub> = 10 μA, V<sub>b</sub> = 22 V min.  
 Reverse Leakage Current @ V<sub>R</sub> = 18 V, I<sub>R</sub> = 100 nA max.

Part Number	Total Capacitance +/-10% <sup>4,5,6,7</sup>	Total Capacitance Ratio <sup>7</sup>	Q Minimum
	V <sub>R</sub> = 4 V f = 1 MHz	V <sub>R</sub> = 2 V / 20 V	V <sub>R</sub> = 4 V f = 50 MHz
	(pF)	-	-
MA46470	0.5	2.2-4.1	4000
MA46471	0.7	3.6-5.6	4000
MA46472	1.0	4.8-7.4	3000
MA46473	1.2	4.8-7.4	3000
MA46474	1.5	5.0-7.4	3000
MA46475	1.8	6.6-8.7	3000
MA46476	2.0	6.6-8.7	3000
MA46477	2.2	6.6-8.7	3000
MA46479 <sup>8</sup>	3.3	6.4-10.0	2000
MA46480	3.7	6.8-11.0	2000
MA46481	4.7	6.9-11.1	1500
MA46483	6.8	7.2-11.5	1500
MA46485	10.0	7.5-12.0	1500

### Gamma = 1.5<sup>3</sup> MA46410 thru MA46425 Series

Gamma = 1.4 - 1.6 VR = 2 - 12 Volts  
 Junction Capacitance Ratio (C<sub>J2</sub>/C<sub>J12</sub>) = 6.2 - 10.8  
 Breakdown Voltage @ I<sub>R</sub> = 10 μA, V<sub>b</sub> = 18 V min.  
 Reverse Leakage Current @ V<sub>R</sub> = 10 V, I<sub>R</sub> = 100 nA max.

Part Number	Total Capacitance +/-10% <sup>4,5,6,7</sup>	Total Capacitance Ratio <sup>7</sup>	Q Minimum
	V <sub>R</sub> = 4 V f = 1 MHz	V <sub>R</sub> = 2 V / 12 V	V <sub>R</sub> = 4 V f = 50 MHz
	(pF)	-	-
MA46410	0.30-0.43	2.7-4.3	3000
MA46413	0.90-1.10	4.2-5.7	2500
MA46416	1.62-1.98	5.2-4.9	2500
MA46418	2.42-2.97	5.7-7.6	1800
MA46425	9.00-11.00	6.6-8.8	1200

- All GaAs tuning varactors are available in chip form. Please contact factory for part number information.
- The values guaranteed for gamma are measured on unpackaged chips. The total capacitance versus bias voltage curve will deviate slightly from the chip capacitance versus bias voltage curve due to the package parasitic capacitance (C<sub>p</sub>).
- Case parasitics (C<sub>p</sub> and L<sub>s</sub>) are given for most case styles along with case outlines in the appendix.
- Closer tolerances are available upon request.
- Reverse voltage (V<sub>br</sub>) is measured at 10 microamps.
- The total capacitance and capacitance ratios shown are for diodes housed in case style 30 with C<sub>p</sub> = 0.170 pF unless otherwise specified. Other case styles will result in different values.
- This part is offered in die form, shipped in a gel pack. The part number is MAVR-046479-01340G.

## Typical Performance Curves

**Gamma vs. Reverse Bias Voltage**

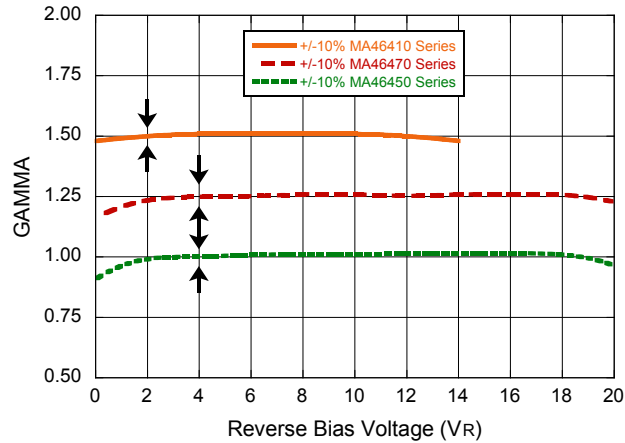

**Gamma = 1.0**  
**Total Capacitance vs. Reverse Bias Voltage**  
*(Packaged parts in case style ODS-30)*

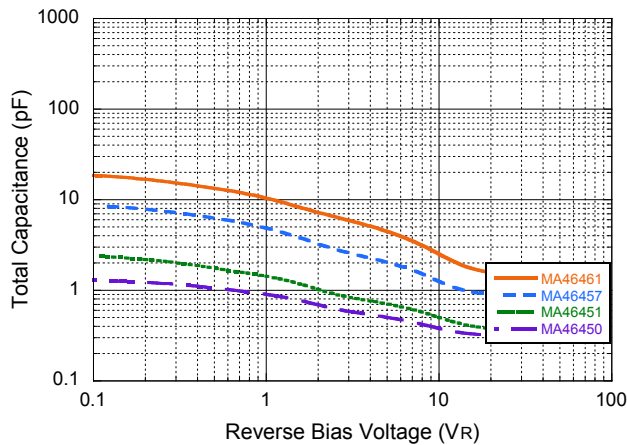

**Gamma = 1.0**  
**Junction Capacitance vs. Reverse Bias Voltage**  
*(DIE)*

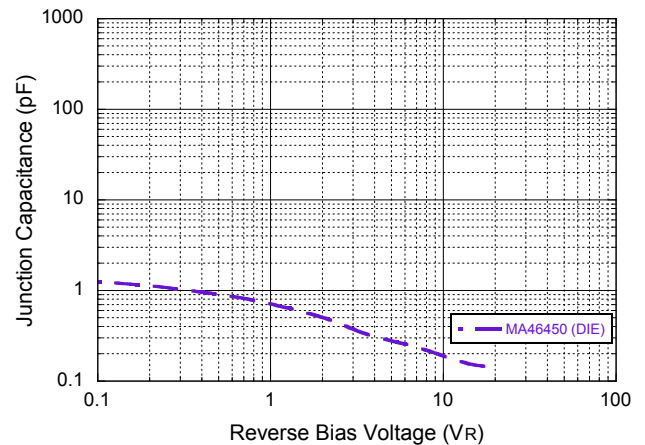

## Typical Performance Curves

**Gamma = 1.25**

**Total Capacitance vs. Reverse Bias Voltage**  
*(Packaged parts in case style ODS-30)*

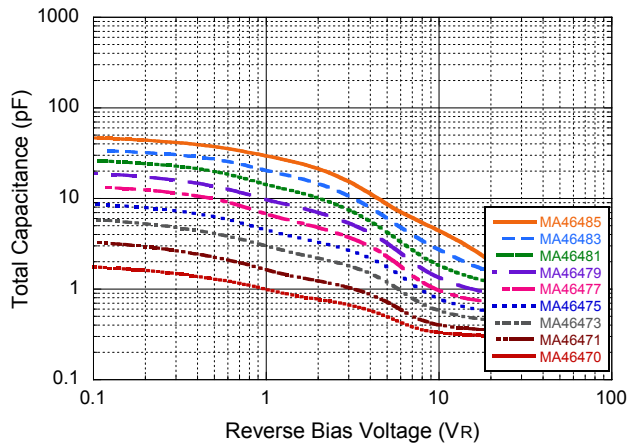

**Gamma = 1.25**

**Junction Capacitance vs. Reverse Bias Voltage**  
*(DIE)*

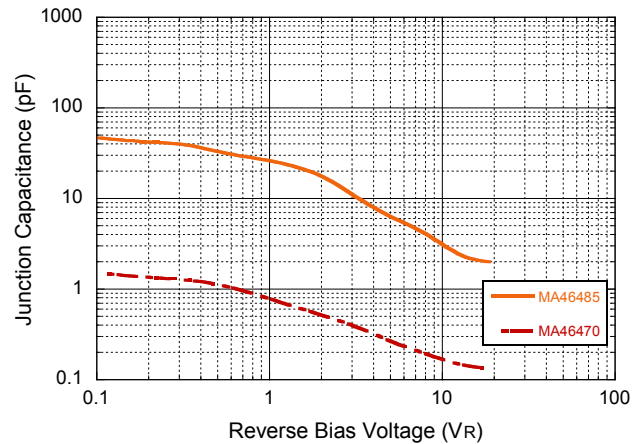

**Gamma = 1.5**

**Total Capacitance vs. Reverse Bias Voltage**  
*(Packaged parts in case style ODS-30)*

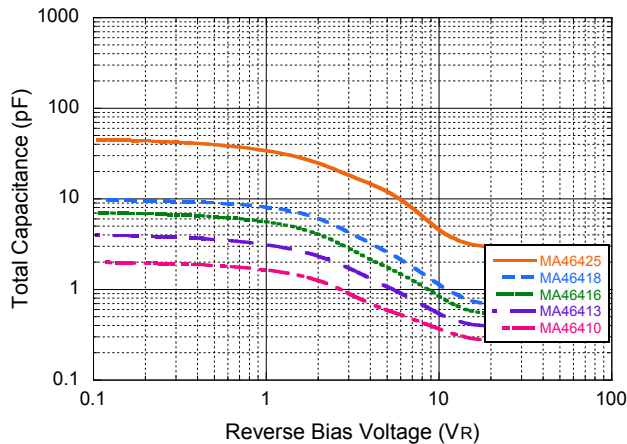

**Gamma = 1.5**

**Junction Capacitance vs. Reverse Bias Voltage**  
*(DIE)*

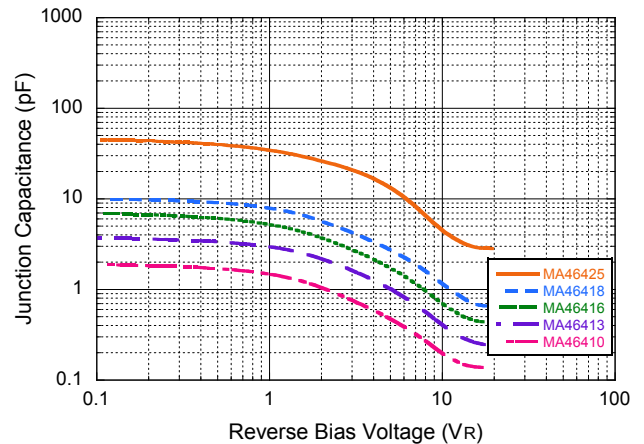

# MA46410 thru MA46480 Series



GaAs Hyperabrupt Varactor Diode  
Gamma = 1.0, 1.25, & 1.5

Rev. V7

## Environmental Ratings per MIL-STD-750

Parameter	Method	Level
Storage Temperature	1031	See Absolute Maximum Ratings
Temperature Cycle	1051	10 cycles, -65°C to +175°C
Shock	2016	500 g's
Vibration	2056	15 g's

## Case Styles (Dimensions are available upon request)

### Typical Coaxial Packages

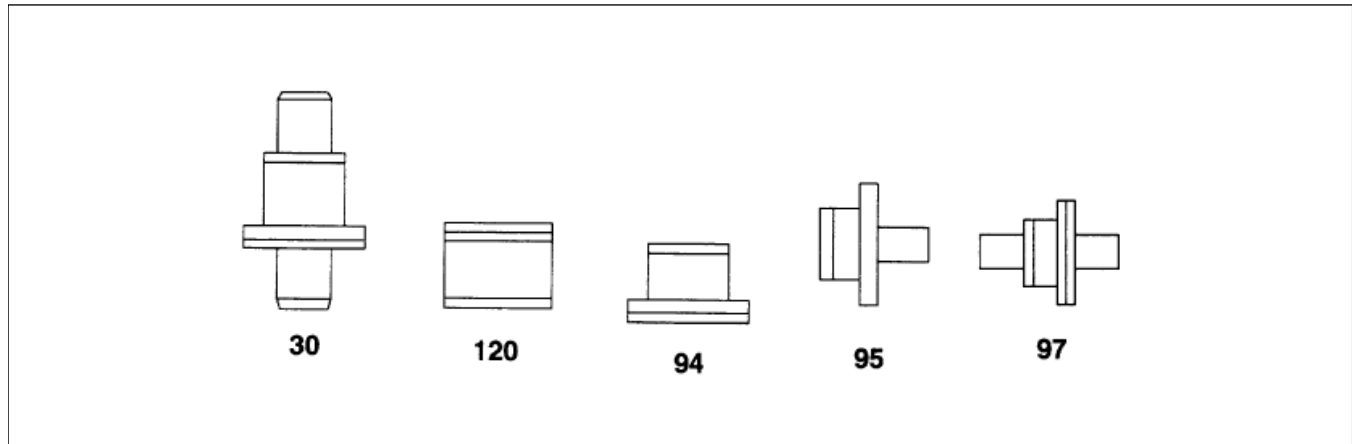

### Typical Coplanar Packages

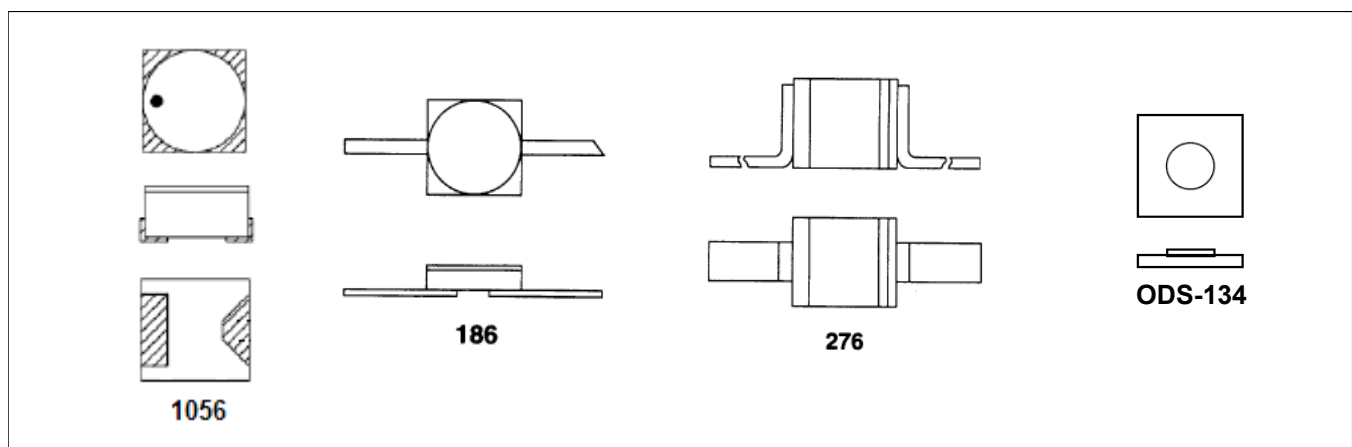

M/A-COM Technology Solutions Inc. All rights reserved.

Information in this document is provided in connection with M/A-COM Technology Solutions Inc ("MACOM") products. These materials are provided by MACOM as a service to its customers and may be used for informational purposes only. Except as provided in MACOM's Terms and Conditions of Sale for such products or in any separate agreement related to this document, MACOM assumes no liability whatsoever. MACOM assumes no responsibility for errors or omissions in these materials. MACOM may make changes to specifications and product descriptions at any time, without notice. MACOM makes no commitment to update the information and shall have no responsibility whatsoever for conflicts or incompatibilities arising from future changes to its specifications and product descriptions. No license, express or implied, by estoppel or otherwise, to any intellectual property rights is granted by this document.

THESE MATERIALS ARE PROVIDED "AS IS" WITHOUT WARRANTY OF ANY KIND, EITHER EXPRESS OR IMPLIED, RELATING TO SALE AND/OR USE OF MACOM PRODUCTS INCLUDING LIABILITY OR WARRANTIES RELATING TO FITNESS FOR A PARTICULAR PURPOSE, CONSEQUENTIAL OR INCIDENTAL DAMAGES, MERCHANTABILITY, OR INFRINGEMENT OF ANY PATENT, COPYRIGHT OR OTHER INTELLECTUAL PROPERTY RIGHT. MACOM FURTHER DOES NOT WARRANT THE ACCURACY OR COMPLETENESS OF THE INFORMATION, TEXT, GRAPHICS OR OTHER ITEMS CONTAINED WITHIN THESE MATERIALS. MACOM SHALL NOT BE LIABLE FOR ANY SPECIAL, INDIRECT, INCIDENTAL, OR CONSEQUENTIAL DAMAGES, INCLUDING WITHOUT LIMITATION, LOST REVENUES OR LOST PROFITS, WHICH MAY RESULT FROM THE USE OF THESE MATERIALS.

MACOM products are not intended for use in medical, lifesaving or life sustaining applications. MACOM customers using or selling MACOM products for use in such applications do so at their own risk and agree to fully indemnify MACOM for any damages resulting from such improper use or sale.

## X-ON Electronics

Largest Supplier of Electrical and Electronic Components

*Click to view similar products for [Varactor Diodes](#) category:*

*Click to view products by [MACOM](#) manufacturer:*

Other Similar products are found below :

[MA46H201-1056](#) [MAVR-001330-12790T](#) [MVAM108](#) [SVC704-TL-E](#) [SVC710-TL-E](#) [1SV324TPH3F](#) [MAVR-000083-0287AT](#) [MAVR-044769-12790T](#) [SVC203C-AA-TB-E](#) [SVC270-TL-E](#) [RKV501KJ#R1](#) [RKV606KL#R1](#) [HVL375CKRF-E](#) [MA46H204-1056](#) [MA46H202-1088](#) [MA46H202-1056](#) [MA46H203-1056](#) [MA46H120](#) [MA46H070-1056](#) [1SV229\(TPH3,F\)](#) [1SV239\(TPH3,F\)](#) [1SV282\(TPH3,F\)](#) [SMV1275-079LF](#) [SVC272-TL-E](#) [GC2510-17](#) [MAVR-001350-12790T](#) [SMV1251-040LF](#) [MAVR-000409-0287FT](#) [GC2521-450A](#) [K VX2301-23-0](#) [K VX3901A-23-4](#) [K VX2162-23-0](#) [K VX1501-23-0](#) [K VX2132-23-0](#) [K VX38S2-23-0](#) [GCX1204-23-0](#) [K VX3901A-23-0](#) [MPV1965-206](#) [K VX2122-23-0](#) [MPV2100-206](#) [K VX2001-23-0](#) [BB172X](#) [BB187LX,315](#) [BB535E7904HTSA1](#) [BBY5303WE6327HTSA1](#) [1SV305,L3F](#) [1SV270TPH3F](#) [1SV239TPH3F](#) [1SV281\(TPH3,F\)](#) [BB545E7904HTSA1](#)