

## Digital Attenuator 31.0 dB, 5-Bit, TTL Driver, DC-3.0 GHz

Rev. V5

### Features

- Attenuation: 1.0dB Steps to 31dB
- Single Positive Supply
- Contains internal DC to DC converter
- Low DC Power Consumption
- Small Footprint, JEDEC Package
- Integral TTL Driver
- 50 ohm Impedance
- Lead-Free CSP-1 Package
- 100% Matte Tin Plating over Copper
- Halogen-Free “Green” Mold Compound
- 260°C Reflow Compatible
- RoHS\* Compliant Version of AT90-1263

### Description

The MAAD-007078 is a GaAs FET 5-bit digital attenuator with integral TTL driver. Step size is 1.0 dB providing 31 dB total attenuation range. This device is in an FQFP-N plastic surface mount package. The MAAD-007078 is ideally suited for use where accuracy, fast speed, very low power consumption and low costs are required.

For dual supply designs without DC-DC converter noise, use MAATCC0010.

### Ordering Information

| Part Number        | Package           |
|--------------------|-------------------|
| MAAD-007078-000100 | Bulk Packaging    |
| MAAD-007078-0001TR | 1000 piece reel   |
| MAAD-007078-0001TB | Sample Test Board |

Note: Reference Application Note M513 for reel size information.

\* Restrictions on Hazardous Substances, European Union Directive 2002/95/EC.

### Functional Schematic

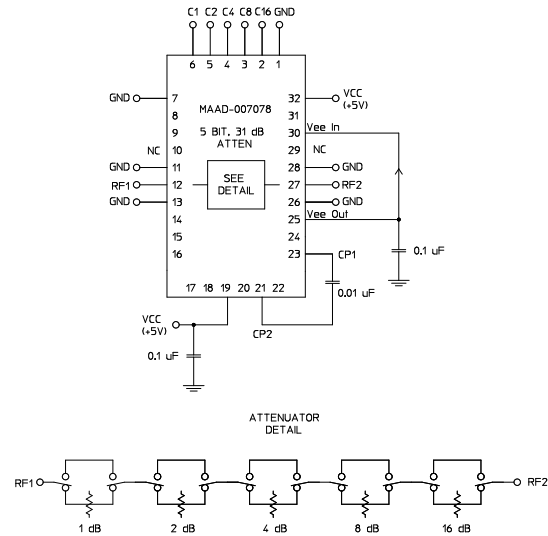

### Pin Configuration

| Pin No. | Function        | Pin No. | Function         |
|---------|-----------------|---------|------------------|
| 1       | GND             | 17      | NC               |
| 2       | C16             | 18      | NC               |
| 3       | C8              | 19      | Vcc              |
| 4       | C4              | 20      | NC               |
| 5       | C2              | 21      | CP2              |
| 6       | C1              | 22      | NC               |
| 7       | GND             | 23      | CP1              |
| 8       | NC              | 24      | NC               |
| 9       | NC              | 25      | Vee <sup>2</sup> |
| 10      | NC <sup>1</sup> | 26      | GND              |
| 11      | GND             | 27      | RF2              |
| 12      | RF1             | 28      | GND              |
| 13      | GND             | 29      | NC <sup>1</sup>  |
| 14      | NC              | 30      | Vee <sup>2</sup> |
| 15      | NC              | 31      | NC               |
| 16      | NC              | 32      | Vcc              |

1. Pins 10 & 29 must be isolated
2. The negative voltage Vee is produced internally and requires a 0.1µF cap to GND. Generated noise is typical of switching DC-DC Converters.
3. The exposed pad centered on the package bottom must be connected to RF and DC ground. (For PQFN Packages)

## Digital Attenuator 31.0 dB, 5-Bit, TTL Driver, DC-3.0 GHz

Rev. V5

### Electrical Specifications: $T_A = 25^\circ\text{C}$ , $Z_0 = 50\Omega$

| Parameter   | Test Conditions   | Frequency                    | Units              | Min  | Typ        | Max        |
|---|---|------------------------------|--------------------|--|------------|------------|
| Insertion Loss  | —   | DC - 3.0 GHz                 | dB                 | —  | 3.5        | 3.8        |
| Attenuation Accuracy  | Individual Bits 1-2-4-8-16 dB<br>Any Combination of Bits 1 to 31 dB | DC - 3.0 GHz<br>DC - 3.0 GHz | dB                 | ±(.3 +5% of atten setting)<br>±(.5 +7% of atten setting) |            |            |
| VSWR  | Full Range  | DC - 3.0 GHz                 | Ratio              | —  | 2.0:1      | 2.2:1      |
| Switching Speed   | 50% Cntl to 90%/10% RF<br>10% to 90% or 90% to 10%                  | —                            | ns                 | —  | 75<br>20   | 150<br>50  |
| 1 dB Compression  | —   | 50 MHz<br>0.5 - 3.0 GHz      | dBm                | —  | +21<br>+24 | —          |
| Input $IP_3$  | Two-tone inputs up to +5 dBm  | 50 MHz<br>0.5-3.0 GHz        | dB                 | —  | +35<br>+48 | —          |
| $V_{CC}$  | —   | —                            | V                  | 4.75   | 5.0        | 5.25       |
| $V_{IL}$<br>$V_{IH}$  | LOW-level input voltage<br>HIGH-level input voltage                 | —<br>—                       | V                  | 0.0<br>2.0   | —<br>—     | 0.8<br>5.0 |
| $I_{in}$ (Input Leakage Current)                                    | $V_{in} = V_{CC}$ or GND  | —                            | $\mu\text{A}$      | -1.0   | —          | 1.0        |
| $I_{CC}^4$  | $V_{CC}$ min to max,<br>Logic "0" or "1"                            | —                            | mA                 | —  | 6          | 10         |
| Turn-on Current <sup>5</sup>  | For guaranteed start-up   | —                            | mA                 | —  | —          | 125        |
| $\Delta I_{CC}$<br>(Additional Supply Current<br>Per TTL Input Pin) | $V_{CC} = \text{Max}$ , $V_{cntrl} = V_{CC} - 2.1 \text{ V}$        | —                            | mA                 | —  | —          | 1.0        |
| Switching Noise   | Generated from<br>DC-DC Converter with<br>recommended capacitors    | 3.5 MHz                      | dBm                | —  | -93        | —          |
| Thermal Resistance $\theta_{jc}$                                    | —   | —                            | $^\circ\text{C/W}$ | —  | 35         | —          |

- During turn-on, the device requires an initial start up current ( $I_{CC}$ ) specified as "Turn-on Current". Once operational,  $I_{CC}$  will drop to the specified levels.
- The DC-DC converter is guaranteed to start in 100  $\mu\text{s}$  as long as the power supplies have the maximum turn-on current available for start up.

### Absolute Maximum Ratings<sup>6,7</sup>

| Parameter                                | Absolute Maximum                                     |
|--|--|
| Input Power<br>0.05 GHz<br>0.5 - 3.0 GHz | +27 dBm<br>+34 dBm                                   |
| $V_{CC}$                                 | $-0.5\text{V} \leq V_{CC} \leq +6.0\text{V}$         |
| $V_{in}^8$                               | $-0.5\text{V} \leq V_{in} \leq V_{CC} + 0.5\text{V}$ |
| Operating Temperature                    | $-40^\circ\text{C}$ to $+85^\circ\text{C}$           |
| Storage Temperature                      | $-65^\circ\text{C}$ to $+125^\circ\text{C}$          |

- Exceeding any one or combination of these limits may cause permanent damage to this device.
- MACOM does not recommend sustained operation near these survivability limits.
- Standard CMOS TTL interface, latch-up will occur if logic signal is applied prior to power supply.

### Recommended PCB Configuration<sup>9</sup>

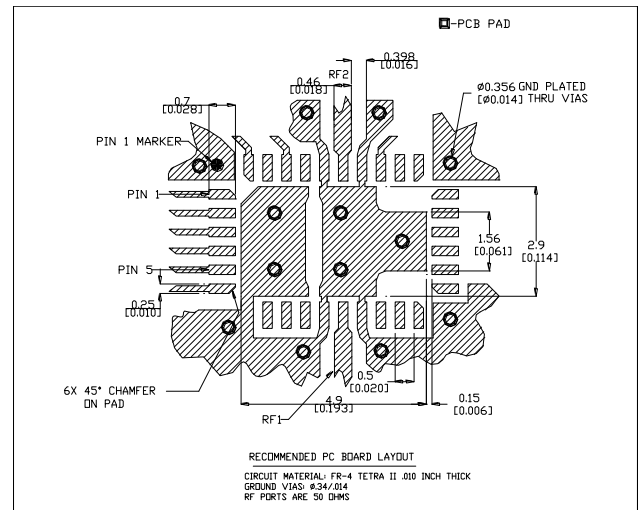

9. Application Note S2083 is available on line at [www.macom.com](http://www.macom.com)

## Digital Attenuator 31.0 dB, 5-Bit, TTL Driver, DC-3.0 GHz

Rev. V5

### Handling Procedures

Please observe the following precautions to avoid damage:

### Static Sensitivity

Gallium Arsenide Integrated Circuits are sensitive to electrostatic discharge (ESD) and can be damaged by static electricity. Proper ESD control techniques should be used when handling these devices.

### Moisture Sensitivity

The MSL rating for this part is defined as Level 2 per IPC/JEDEC J-STD-020. Parts shall be stored and/or baked as required for MSL Level 2 parts.

### Typical Performance Curves

#### Insertion Loss

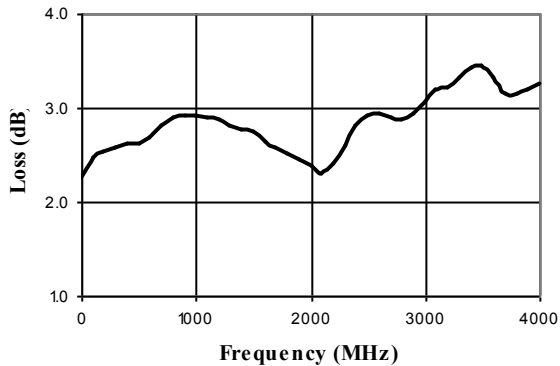

#### Attenuation Error, 1 dB Bit

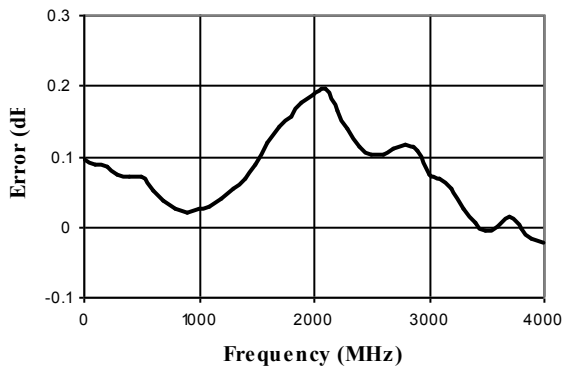

### Truth Table (Digital Attenuator)

| C16 | C8 | C4 | C2 | C1 | Attenuation     |
|-----|----|----|----|----|-----------------|
| 0   | 0  | 0  | 0  | 0  | Loss, Reference |
| 0   | 0  | 0  | 0  | 1  | 1.0 dB          |
| 0   | 0  | 0  | 1  | 0  | 2.0 dB          |
| 0   | 0  | 1  | 0  | 0  | 4.0 dB          |
| 0   | 1  | 0  | 0  | 0  | 8.0 dB          |
| 1   | 0  | 0  | 0  | 0  | 16.0 dB         |
| 1   | 1  | 1  | 1  | 1  | 31.0 dB         |

0 = TTL Low; 1 = TTL High

#### VSWR @ Insertion Loss

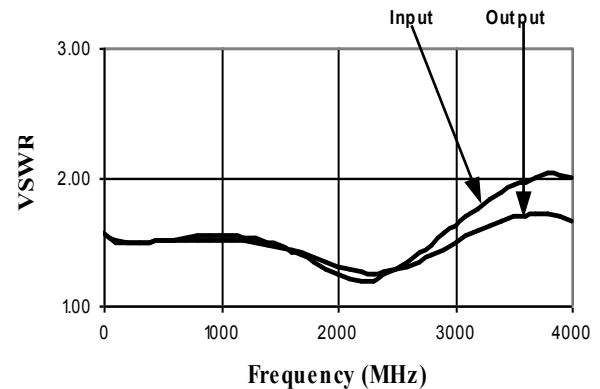

#### Attenuation Error, 2 dB Bit

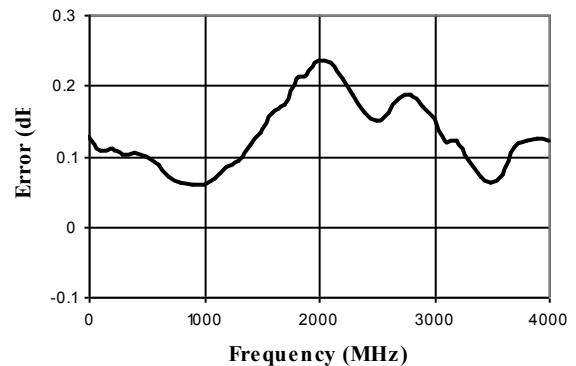

## Typical Performance Curves

*Attenuation Error, 4 dB Bit*

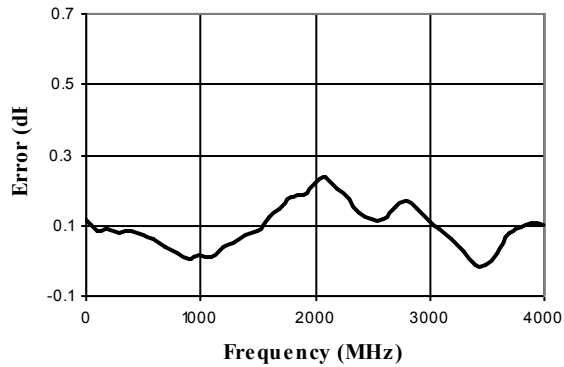

*Attenuation Error, 8 dB Bit*

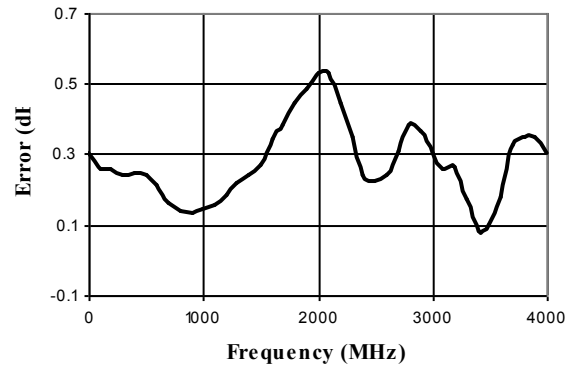

*Attenuation Error, 16 dB Bit*

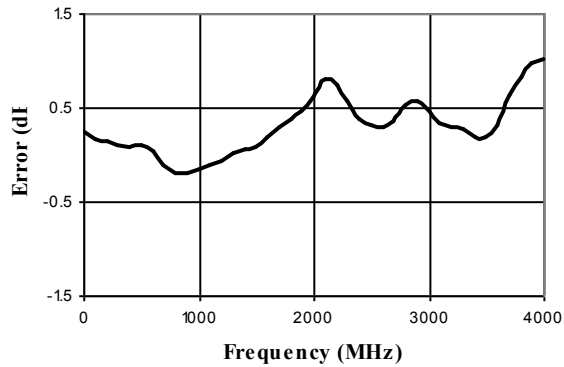

*Attenuation Error, Max. Attenuation*

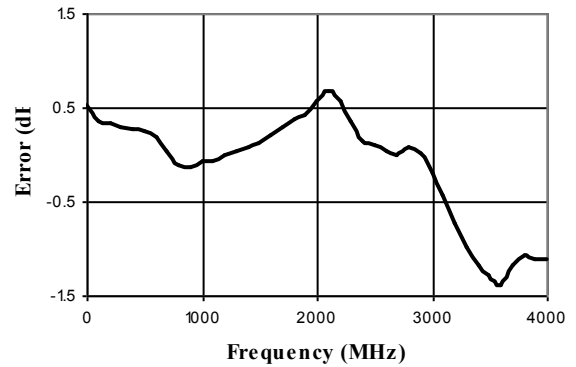

*VSWR, 1 dB Bit*

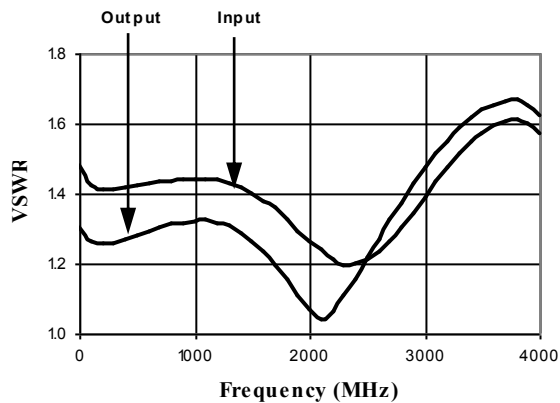

*VSWR, 2 dB Bit*

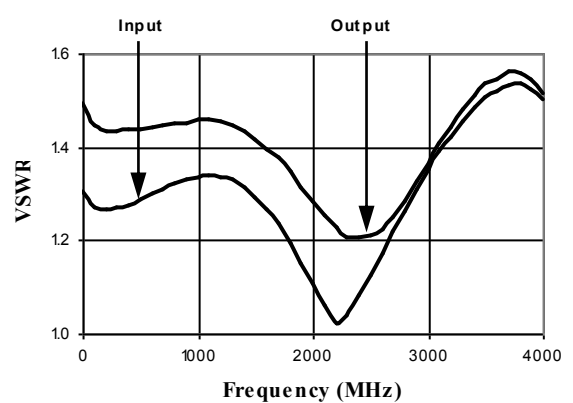

## Typical Performance Curves

*VSWR, 4 dB Bit*

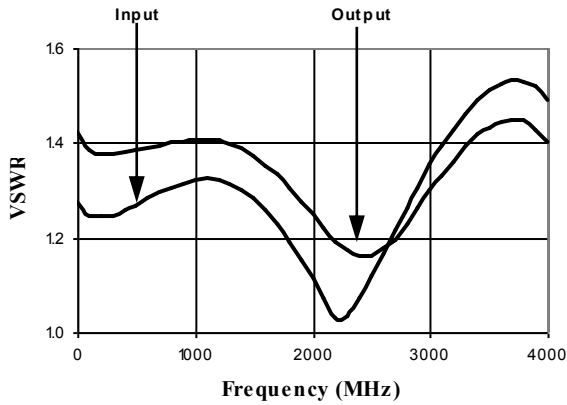

*VSWR, 8 dB Bit*

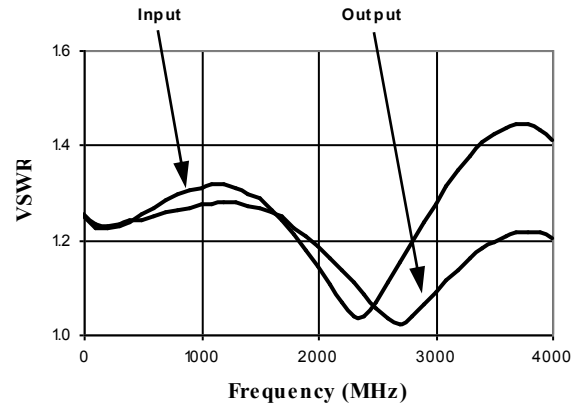

*VSWR, 16 dB Bit*

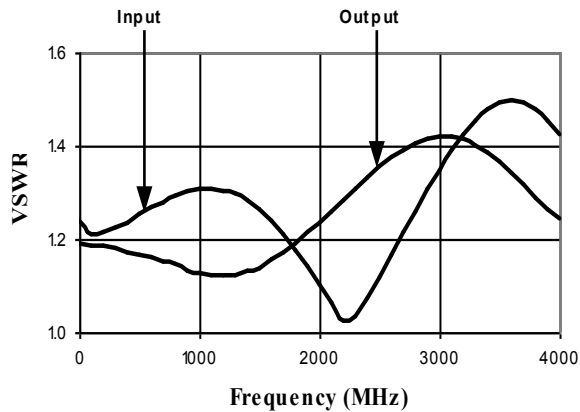

*VSWR, Maximum Attenuation*

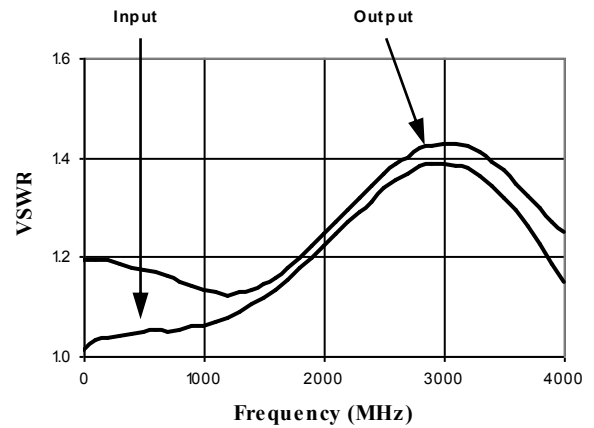

**Digital Attenuator**  
**31.0 dB, 5-Bit, TTL Driver, DC-3.0 GHz**

Rev. V5

**CSP-1, Lead-Free 4 x 6 mm, 32-lead**

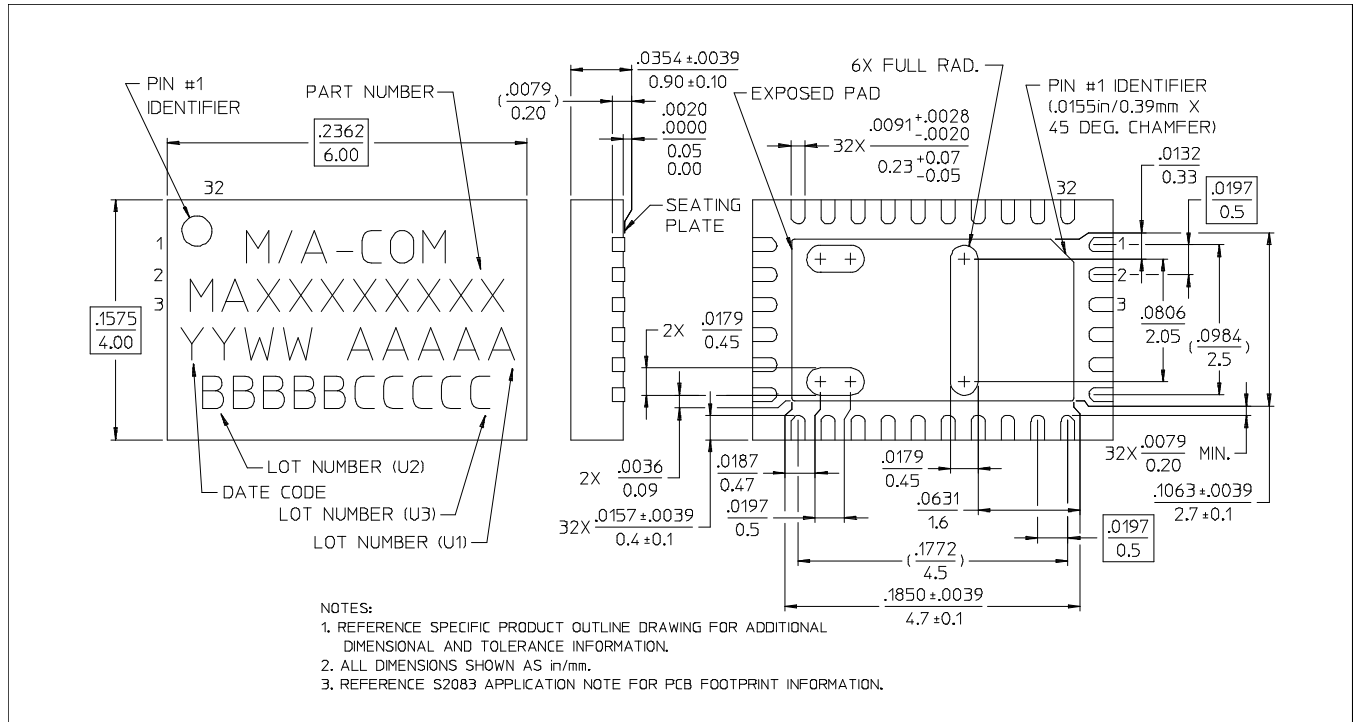

† Reference Application Note M538 for lead-free solder reflow recommendations.

M/A-COM Technology Solutions Inc. All rights reserved.

Information in this document is provided in connection with M/A-COM Technology Solutions Inc ("MACOM") products. These materials are provided by MACOM as a service to its customers and may be used for informational purposes only. Except as provided in MACOM's Terms and Conditions of Sale for such products or in any separate agreement related to this document, MACOM assumes no liability whatsoever. MACOM assumes no responsibility for errors or omissions in these materials. MACOM may make changes to specifications and product descriptions at any time, without notice. MACOM makes no commitment to update the information and shall have no responsibility whatsoever for conflicts or incompatibilities arising from future changes to its specifications and product descriptions. No license, express or implied, by estoppel or otherwise, to any intellectual property rights is granted by this document.

THESE MATERIALS ARE PROVIDED "AS IS" WITHOUT WARRANTY OF ANY KIND, EITHER EXPRESS OR IMPLIED, RELATING TO SALE AND/OR USE OF MACOM PRODUCTS INCLUDING LIABILITY OR WARRANTIES RELATING TO FITNESS FOR A PARTICULAR PURPOSE, CONSEQUENTIAL OR INCIDENTAL DAMAGES, MERCHANTABILITY, OR INFRINGEMENT OF ANY PATENT, COPYRIGHT OR OTHER INTELLECTUAL PROPERTY RIGHT. MACOM FURTHER DOES NOT WARRANT THE ACCURACY OR COMPLETENESS OF THE INFORMATION, TEXT, GRAPHICS OR OTHER ITEMS CONTAINED WITHIN THESE MATERIALS. MACOM SHALL NOT BE LIABLE FOR ANY SPECIAL, INDIRECT, INCIDENTAL, OR CONSEQUENTIAL DAMAGES, INCLUDING WITHOUT LIMITATION, LOST REVENUES OR LOST PROFITS, WHICH MAY RESULT FROM THE USE OF THESE MATERIALS.

MACOM products are not intended for use in medical, lifesaving or life sustaining applications. MACOM customers using or selling MACOM products for use in such applications do so at their own risk and agree to fully indemnify MACOM for any damages resulting from such improper use or sale.

## X-ON Electronics

Largest Supplier of Electrical and Electronic Components

*Click to view similar products for [Attenuators](#) category:*

*Click to view products by [MACOM](#) manufacturer:*

Other Similar products are found below :

[HMC305SLP4ETR](#) [MAAD-009195-000100](#) [TGL4201-00](#) [TGL4201-02](#) [TGL4201-03](#) [TGL4201-06](#) [TGL4201-10](#) [ATN3590-15](#) [20-50TPC](#)  
[D10AA5Z4](#) [18AH-01](#) [18AH-08](#) [ATN3590-09](#) [20-50RP](#) [PCAF-10](#) [EXB-24AT9AR5X](#) [ATN3580-06](#) [ATN3580-10](#) [HMC539ALP3ETR](#)  
[ATN3580-02](#) [WA04P006XCTL](#) [SKY12408-321LF](#) [ATN3580-03](#) [WA04P005XBTL](#) [HMC-VVD104-SX](#) [WA04P007XCTL](#) [SKY12236-11](#)  
[MAATSS0018TR-3000](#) [HMC656-SX](#) [WA04P001XBTL](#) [MAAV-007941-TR3000](#) [WA04P004XBTL](#) [WA04P002XBTL](#) [EXB-24N182JX](#)  
[EXB-24N181JX](#) [EXB-24N183JX](#) [C3A50Z4](#) [HMC941A](#) [PAT0816-C-0DB-T5](#) [PAT0816-C-8DB-T5](#) [PAT1632-C-3DB-T1](#) [PAT1632-C-6DB-](#)  
[T1](#) [PAT1632-C-10DB-T1](#) [PAT1632-C-1DB-T1](#) [PAT0816-C-2DB-T5](#) [PAT0816-C-4DB-T5](#) [DHM510-0100-006](#) [CMD172](#) [MAT10300](#)  
[MAT10180](#)