

## Digital Attenuator 15.5 dB, 5-Bit, TTL Driver, DC-3.5 GHz

Rev. V4

### Features

- Attenuation: 0.5 dB Steps to 15.5 dB
- Low DC Power Consumption
- Small Footprint, JEDEC Package
- Integral TTL Driver
- 50 ohm Impedance
- Test Boards are Available
- Tape and Reel Packaging Available
- Lead-Free CSP-1 Package
- 100% Matte Tin Plating over Copper
- Halogen-Free “Green” Mold Compound
- 260°C Reflow Compatible
- RoHS\* Compliant Version of AT90-0283

### Description

M/A-COM's MAAD-007081-000100 is a GaAs FET 5-bit digital attenuator with integral TTL driver. Step size is 0.5 dB providing a 15.5 dB total attenuation range. This device is in an PQFN plastic surface mount package. MAAD-007081-000100 is ideally suited for use where accuracy, fast speed, very low power consumption and low costs are required.

### Functional Schematic

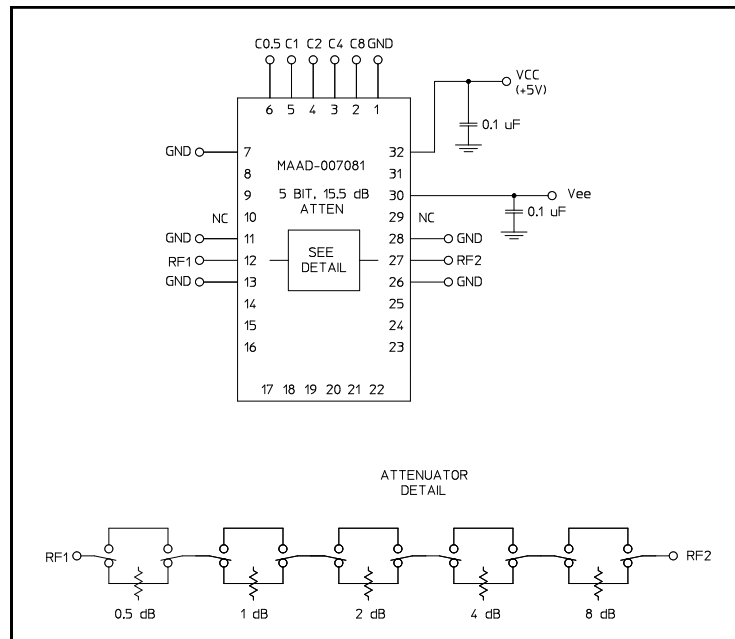

### Pin Configuration<sup>1</sup>

Pin No.	Function	Pin No.	Function
1	GND	17	NC
2	C8	18	NC
3	C4	19	NC
4	C2	20	NC
5	C1	21	NC
6	C0.5	22	NC
7	GND	23	NC
8	NC	24	NC
9	NC	25	NC
10	NC <sup>2</sup>	26	GND
11	GND	27	RF2
12	RF1	28	GND
13	GND	29	NC <sup>2</sup>
14	NC	30	-Vee
15	NC	31	NC
16	NC	32	+Vcc

### Ordering Information

Part Number	Package
MAAD-007081-000100	Bulk Packaging
MAAD-007081-0001TR	1000 piece reel
MAAD-007081-0001TB	Sample Test Board

Note: Reference Application Note M513 for reel size information.

\* Restrictions on Hazardous Substances, European Union Directive 2002/95/EC.

1. The exposed pad centered on the package bottom must be connected to RF and DC ground. (For PQFN Packages)  
2. Pins 10 & 29 must be isolated

## Digital Attenuator 15.5 dB, 5-Bit, TTL Driver, DC-3.5 GHz

Rev. V4

### Electrical Specifications: $T_A = 25^\circ\text{C}$ , $Z_0 = 50\Omega$

Parameter	Test Conditions	Frequency	Units	Min	Typ	Max
Insertion Loss	—	DC - 3.5 GHz	dB	—	2.8	3.2
Attenuation Accuracy	Individual Bits 0.5-1-4-8 dB Individual Bit 2 dB Any Combination of Bits 1 to 15.5 dB	DC - 3.5 GHz	dB	—	—	$\pm(.3 + 5\%$ of atten setting)
		DC - 3.5 GHz	dB	—	—	$\pm(.4 + 10\%$ of atten setting)
		DC - 3.5 GHz	dB	—	—	$\pm(.5 + 7\%$ of atten setting)
VSWR	Full Range	DC - 3.5 GHz	Ratio	—	1.6:1	1.8:1
Switching Speed	50% Cntl to 90%/10% RF 10% to 90% or 90% to 10%	—	ns	—	75	150
		—	ns	—	20	50
1 dB Compression	—	50 MHz	dBm	—	+21	—
		0.5 - 3.5 GHz	dBm	—	+29	—
Input $IP_3$	Two-tone inputs up to +5 dBm	50 MHz	dB	—	+35	—
		0.5-3.5 GHz	dB	—	+48	—
$V_{CC}$	—	—	V	4.75	5.0	5.25
$V_{EE}$	—	—	V	-8.0	-5.0	-4.75
$V_{IL}$	LOW-level input voltage	—	V	0.0	—	0.8
$V_{IH}$	HIGH-level input voltage	—	V	2.0	—	5.0
$I_{in}$ (Input Leakage Current)	$V_{in} = V_{CC}$ or GND	—	$\mu\text{A}$	-1.0	—	1.0
$I_{CC}$ (Quiescent Supply Current)	$V_{cntrl} = V_{CC}$ or GND	—	$\mu\text{A}$	—	250	400
$\Delta I_{CC}$ (Additional Supply Current Per TTL Input Pin)	$V_{CC} = \text{Max}$ , $V_{cntrl} = V_{CC} - 2.1\text{ V}$	—	mA	—	—	1.0
$I_{EE}$	$V_{EE}$ min to max, $V_{in} = V_{IL}$ or $V_{IH}$	—	mA	-1.0	-0.2	—
Thermal Resistance $\theta_{jc}$	—	—	$^\circ\text{C/W}$	—	15	—

### Absolute Maximum Ratings <sup>3,4</sup>

Parameter	Absolute Maximum
Max. Input Power 0.05 GHz 0.5 - 3.5 GHz	+27 dBm +34 dBm
$V_{CC}$	$-0.5V \leq V_{CC} \leq +7.0V$
$V_{EE}$	$-8.5V \leq V_{EE} \leq +0.5V$
$V_{CC} - V_{EE}$	$-0.5V \leq V_{CC} - V_{EE} \leq 14.5V$
$V_{in}^5$	$-0.5V \leq V_{in} \leq V_{CC} + 0.5V$
Operating Temperature	-40°C to +85°C
Storage Temperature	-65°C to +125°C

- Exceeding any one or combination of these limits may cause permanent damage to this device.
- M/A-COM does not recommend sustained operation near these survivability limits.
- Standard CMOS TTL interface, latch-up will occur if logic signal is applied prior to power supply.

### Recommended PCB Configuration <sup>6</sup>

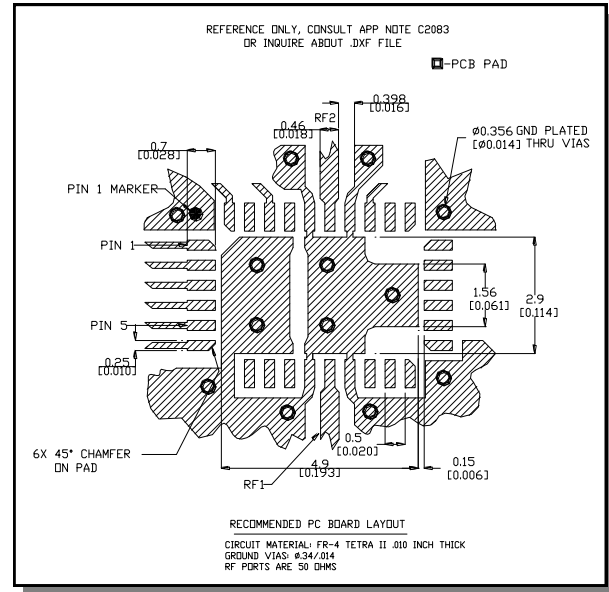

- Application Note C2083 is available on line at [www.macom.com](http://www.macom.com)

### Handling Procedures

Please observe the following precautions to avoid damage:

#### Static Sensitivity

Gallium Arsenide Integrated Circuits are sensitive to electrostatic discharge (ESD) and can be damaged by static electricity. Proper ESD control techniques should be used when handling these devices.

#### Moisture Sensitivity

The MSL rating for this part is defined as Level 2 per IPC/JEDEC J-STD-020. Parts shall be stored and/or baked as required for MSL Level 2 parts.

### Truth Table (Digital Attenuator)

C8	C4	C2	C1	C0.5	Attenuation
0	0	0	0	0	Loss, Reference
0	0	0	0	1	0.5 dB
0	0	0	1	0	1.0 dB
0	0	1	0	0	2.0 dB
0	1	0	0	0	4.0 dB
1	0	0	0	0	8.0 dB
1	1	1	1	1	15.5 dB

0 = TTL Low; 1 = TTL High

## Typical Performance Curves

*Insertion Loss*

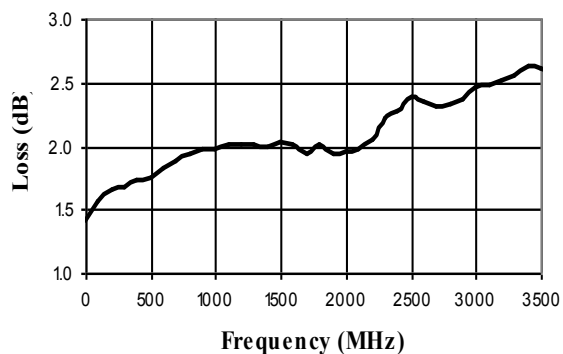

*VSWR @ Insertion Loss*

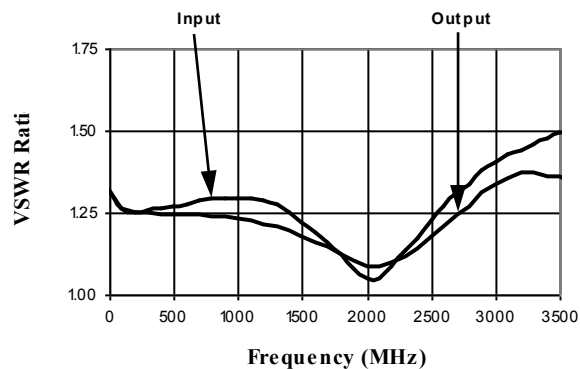

*Attenuation Error, 0.5 dB Bit*

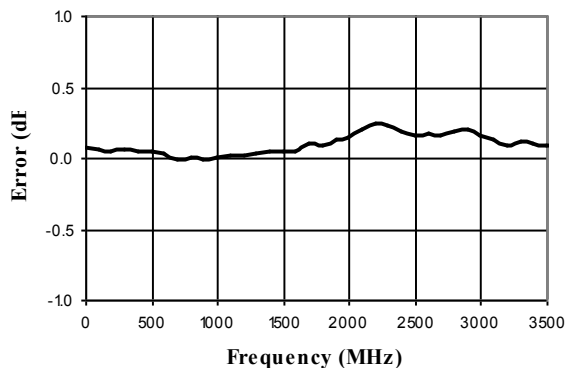

*Attenuation Error, 1 dB Bit*

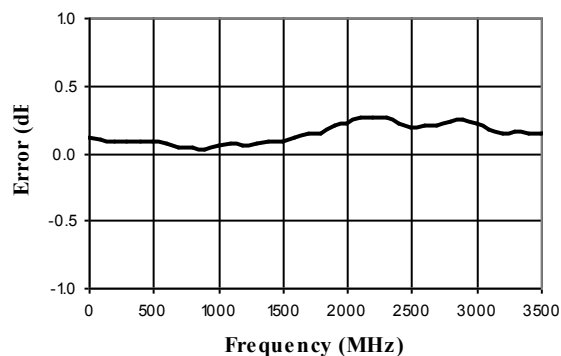

*Attenuation Error, 2 dB Bit*

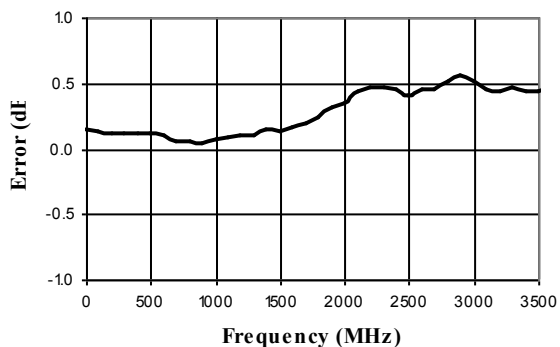

*Attenuation Error, 4 dB Bit*

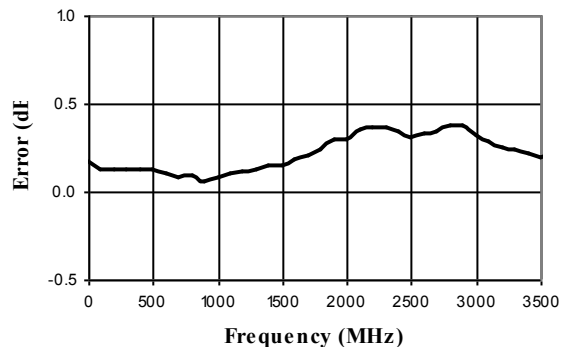

## Typical Performance Curves

*Attenuation Error, 8 dB Bit*

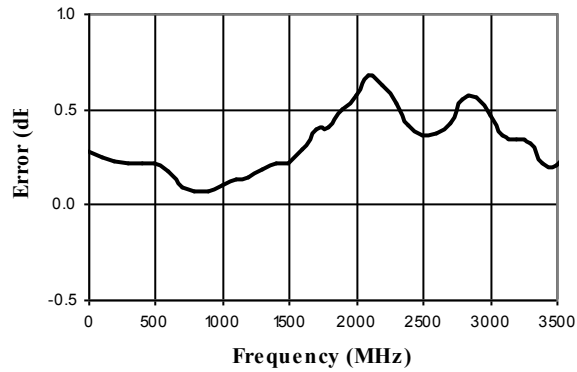

*Attenuation Error, Max. Attenuation*

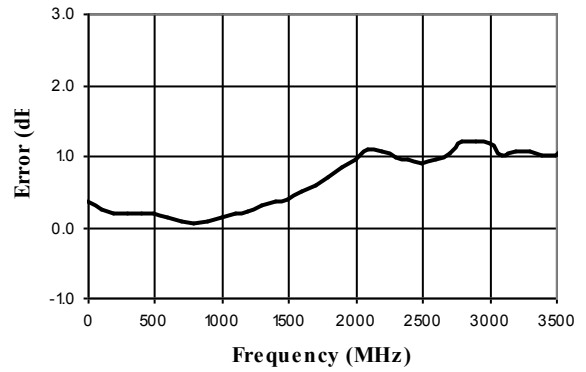

*VSWR, 0.5 dB Bit*

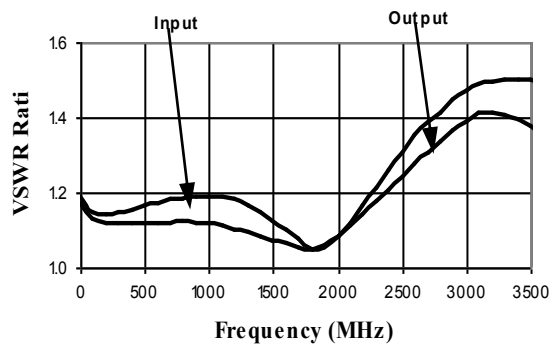

*VSWR, 1 dB Bit*

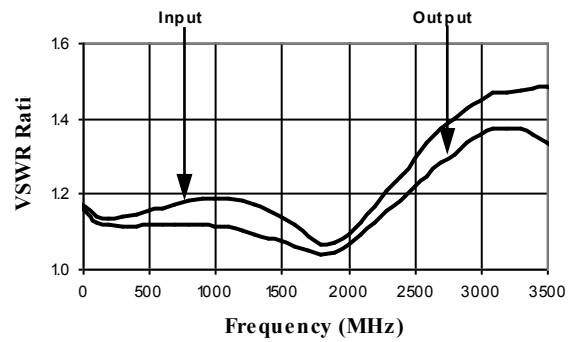

## Typical Performance Curves

VSWR, 2 dB Bit

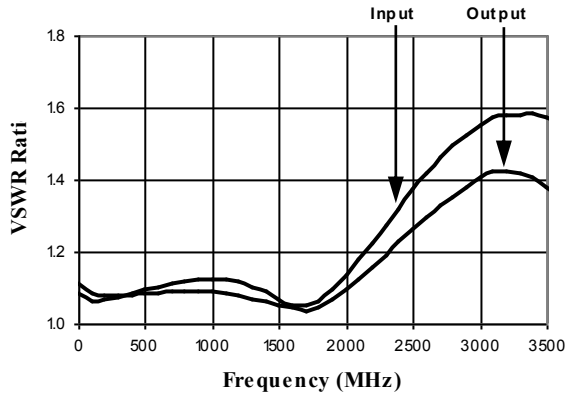

VSWR, 4 dB Bit

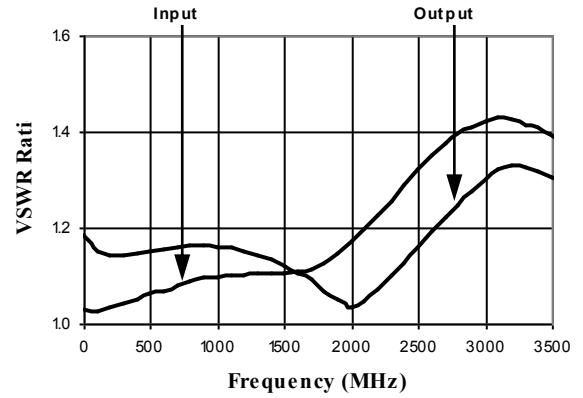

VSWR, 8 dB Bit

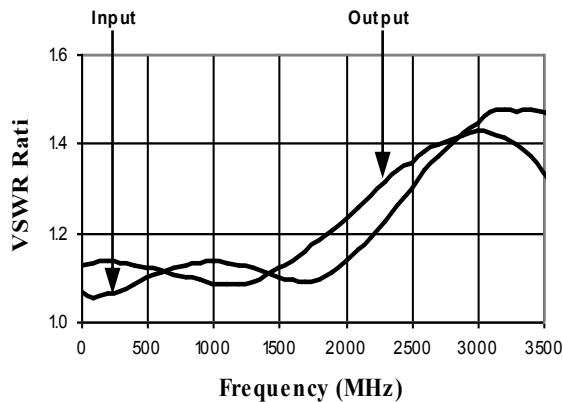

VSWR, Maximum Attenuation

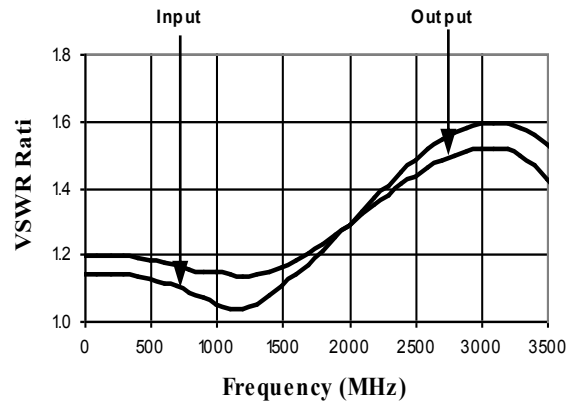

**Digital Attenuator**  
**15.5 dB, 5-Bit, TTL Driver, DC-3.5 GHz**

Rev. V4

**CSP-1, Lead-Free 4 x 6 mm, 32-lead**  
**PQFN†**

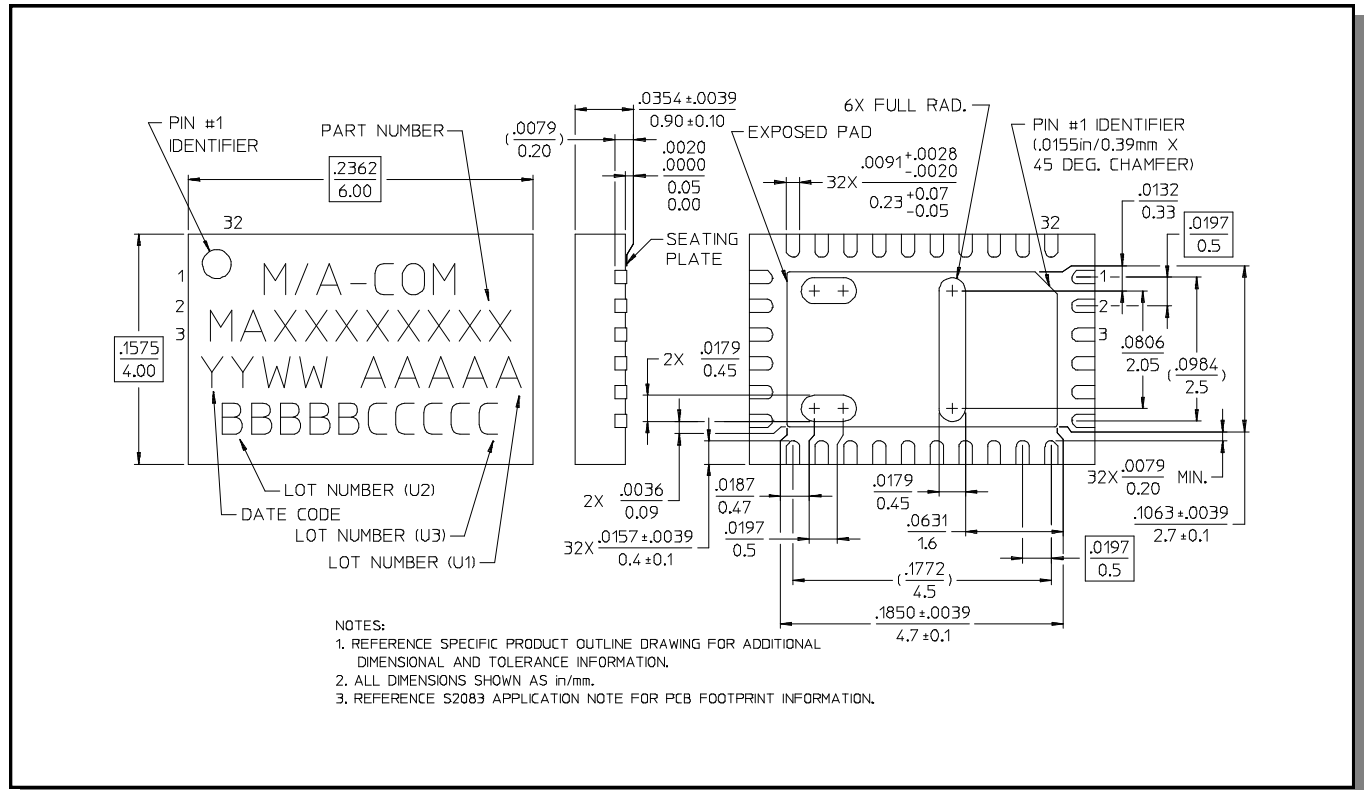

† Reference Application Note M538 for lead-free solder reflow recommendations.

M/A-COM Technology Solutions Inc. All rights reserved.

Information in this document is provided in connection with M/A-COM Technology Solutions Inc ("MACOM") products. These materials are provided by MACOM as a service to its customers and may be used for informational purposes only. Except as provided in MACOM's Terms and Conditions of Sale for such products or in any separate agreement related to this document, MACOM assumes no liability whatsoever. MACOM assumes no responsibility for errors or omissions in these materials. MACOM may make changes to specifications and product descriptions at any time, without notice. MACOM makes no commitment to update the information and shall have no responsibility whatsoever for conflicts or incompatibilities arising from future changes to its specifications and product descriptions. No license, express or implied, by estoppel or otherwise, to any intellectual property rights is granted by this document.

THESE MATERIALS ARE PROVIDED "AS IS" WITHOUT WARRANTY OF ANY KIND, EITHER EXPRESS OR IMPLIED, RELATING TO SALE AND/OR USE OF MACOM PRODUCTS INCLUDING LIABILITY OR WARRANTIES RELATING TO FITNESS FOR A PARTICULAR PURPOSE, CONSEQUENTIAL OR INCIDENTAL DAMAGES, MERCHANTABILITY, OR INFRINGEMENT OF ANY PATENT, COPYRIGHT OR OTHER INTELLECTUAL PROPERTY RIGHT. MACOM FURTHER DOES NOT WARRANT THE ACCURACY OR COMPLETENESS OF THE INFORMATION, TEXT, GRAPHICS OR OTHER ITEMS CONTAINED WITHIN THESE MATERIALS. MACOM SHALL NOT BE LIABLE FOR ANY SPECIAL, INDIRECT, INCIDENTAL, OR CONSEQUENTIAL DAMAGES, INCLUDING WITHOUT LIMITATION, LOST REVENUES OR LOST PROFITS, WHICH MAY RESULT FROM THE USE OF THESE MATERIALS.

MACOM products are not intended for use in medical, lifesaving or life sustaining applications. MACOM customers using or selling MACOM products for use in such applications do so at their own risk and agree to fully indemnify MACOM for any damages resulting from such improper use or sale.

8

---

M/A-COM Technology Solutions Inc. (MACOM) and its affiliates reserve the right to make changes to the product(s) or information contained herein without notice.  
Visit [www.macom.com](http://www.macom.com) for additional data sheets and product information.



## X-ON Electronics

Largest Supplier of Electrical and Electronic Components

*Click to view similar products for [Attenuators](#) category:*

*Click to view products by [MACOM](#) manufacturer:*

Other Similar products are found below :

[HMC305SLP4ETR](#) [MAAD-009195-000100](#) [TGL4201-00](#) [TGL4201-02](#) [TGL4201-03](#) [TGL4201-06](#) [TGL4201-10](#) [ATN3590-15](#) [20-50TPC](#)  
[D10AA5Z4](#) [18AH-01](#) [18AH-08](#) [ATN3590-09](#) [20-50RP](#) [PCAF-10](#) [EXB-24AT9AR5X](#) [ATN3580-06](#) [ATN3580-10](#) [HMC539ALP3ETR](#)  
[ATN3580-02](#) [WA04P006XCTL](#) [SKY12408-321LF](#) [ATN3580-03](#) [WA04P005XBTL](#) [HMC-VVD104-SX](#) [WA04P007XCTL](#) [SKY12236-11](#)  
[MAATSS0018TR-3000](#) [HMC656-SX](#) [WA04P001XBTL](#) [MAAV-007941-TR3000](#) [WA04P004XBTL](#) [WA04P002XBTL](#) [EXB-24N182JX](#)  
[EXB-24N181JX](#) [EXB-24N183JX](#) [C3A50Z4](#) [HMC941A](#) [PAT0816-C-0DB-T5](#) [PAT0816-C-8DB-T5](#) [PAT1632-C-3DB-T1](#) [PAT1632-C-6DB-](#)  
[T1](#) [PAT1632-C-10DB-T1](#) [PAT1632-C-1DB-T1](#) [PAT0816-C-2DB-T5](#) [PAT0816-C-4DB-T5](#) [DHM510-0100-006](#) [CMD172](#) [MAT10300](#)  
[MAT10180](#)