

Low Noise Amplifier 5 - 4000 MHz

Rev. V2

Features

- Single Stage, Single Ended
- 75 Ω CATV, 5 - 1218 MHz
- 21 dB Flat Gain
- 1 dB Noise Figure
- 50 Ω System, 5 - 2000 MHz
- 17 dB Gain
- 1.5 dB Noise Figure @ 1.5 GHz
- 17 dB Maximum Available Gain @ 4 GHz
- 75 Ω CATV Full Duplex, 5 - 700 MHz
- Adjustable Current, 20 - 85 mA
- Excellent Return Loss
- Low Distortion Performance
- 3 V to 5 V Operation
- Lead-Free SOT-89 Plastic Package
- Halogen-Free “Green” Mold Compound
- RoHS* Compliant

Description

The MAAL-011139 is an RF amplifier assembled in a SOT-89 plastic package. In a 75 Ω CATV application, the amplifier provides 21.5 dB of flat gain while biased from 3 to 5 volts. The amplifier provides superior noise figure while maintaining excellent return losses. Gain and current may be optimized with adjustment of external component values.

The MAAL-011139 provides high gain, low noise and low distortion making it ideally suited as input stage for fiber-to-the-home (FTTh) applications and other 75 Ω infrastructure applications. It can support both upstream (5 - 204 MHz) and downstream (45 - 1218 MHz) CATV operation.

It can also be used for 75 Ω CATV Full Duplex applications (5 - 700 MHz) with appropriate external components.

The MAAL-011139 can also be matched into a 50-ohm system. In a broadband 50 - 2000 MHz application, the amplifier provides 17 dB of flat gain. The MAAL-011139 offers 17 dB of available gain beyond 4 GHz.

Functional Schematic

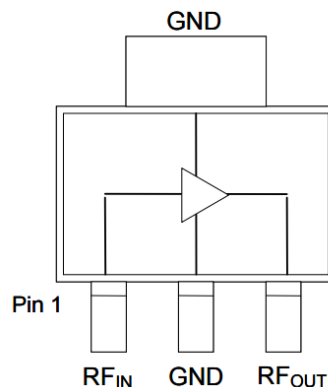

Pin Configuration

Pin #	Pin Name	Function
1	RF _{IN}	RF Input
2	GND	Ground
3	RF _{OUT}	RF Output / V _{DD}

Ordering Information^{1,2}

Part Number	Package
MAAL-011139-TR1000	1000 Part Reel
MAAL-011139-TR3000	3000 Part Reel
MAAL-011139-DSBSMB	Sample Board 45 - 1218 MHz
MAAL-011139-USBSMB	Sample Board 5 - 300 MHz
MAAL-011139-050SMB	Sample Board, 5 - 2000 MHz

1. Reference Application Note M513 for reel size information.
2. All production sample boards include 5 loose parts.

* Restrictions on Hazardous Substances, compliant to current RoHS EU directive.

Low Noise Amplifier 5 - 4000 MHz

Rev. V2

Electrical Specifications: $T_A = 25^\circ\text{C}$, $V_{DD} = 5\text{ V}$, $Z_0 = 75\ \Omega$, 45 - 1218 MHz Application

Parameter	Test Conditions	Units	Min.	Typ.	Max.
Gain	—	dB	20.5	21.5	22.5
Gain Flatness	—	dB	—	+/- 0.2	—
Reverse Isolation	—	dB	—	25	—
Input Return Loss	—	dB	—	23	—
Output Return Loss	—	dB	—	23	—
Noise Figure	45 MHz 1218 MHz	dB	—	1.2 1.4	1.8
Output IP2	45 - 1200 MHz, tone spacing 6 MHz, P_{OUT} per tone = 0 dBm	dBm	—	42	—
Output IP3	45 - 1200 MHz, tone spacing 6 MHz, P_{OUT} per tone = 0 dBm	dBm	—	34	—
P1dB	—	dBm	—	19	—
Composite Triple Beat (CTB)	79 channels, 0 dB Tilt, 32 dBmV per channel output, QAM to 1000 MHz	dBc	—	-68	—
Composite Second Order (CSO)	79 channels, 0 dB Tilt, 32 dBmV per channel output, QAM to 1000 MHz	dBc	—	-61	—
I_{DD}	—	mA	—	85	100

Absolute Maximum Ratings^{3,4,5}

Parameter	Absolute Maximum
Input Power	17 dBm
Voltage	7 V
Operating Temperature	-40°C to +85°C
Storage Temperature	-65°C to +150°C
Junction Temperature ⁶	150°C

- Exceeding any one or combination of these limits may cause permanent damage to this device.
- MACOM does not recommend sustained operation near these survivability limits.
- Operating at nominal conditions with $T_J \leq 150^\circ\text{C}$ will ensure $MTTF > 1 \times 10^6$ hours.
- Junction Temperature (T_J) = $T_C + \Theta_{JC} \cdot (V \cdot I)$
Typical thermal resistance (Θ_{JC}) = 63°C/W.
 - For $T_C = 25^\circ\text{C}$,
 $T_J = 52^\circ\text{C}$ @ 5 V, 85 mA
 - For $T_C = 85^\circ\text{C}$,
 $T_J = 108^\circ\text{C}$ @ 5 V, 72 mA

Handling Procedures

Please observe the following precautions to avoid damage:

Static Sensitivity

Integrated Circuits are sensitive to electrostatic discharge (ESD) and can be damaged by static electricity. Proper ESD control techniques should be used when handling these Class 1C devices.

Low Noise Amplifier 5 - 4000 MHz

Rev. V2

Schematic Including Off-Chip Components 45 - 1218 MHz Application

Parts List, $V_{DD} = 5\text{ V}$, 85 mA

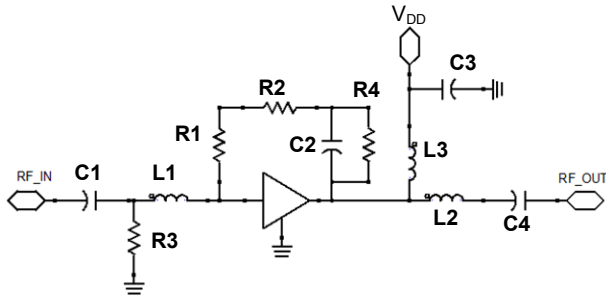

Component	Value	Package
C1 - C3	10 nF	0402
C4	270 pF	0402
L1	6.2 nH	0402
L2	3.3 nH	0402
L3	Ferrite Bead ⁷	0402
R1 - R2	510 Ω	0402
R3	10 k Ω	0402
R4	30.1 k Ω	0402

7. Murata, part number BLM15HD182SN.

Recommended PCB Layout

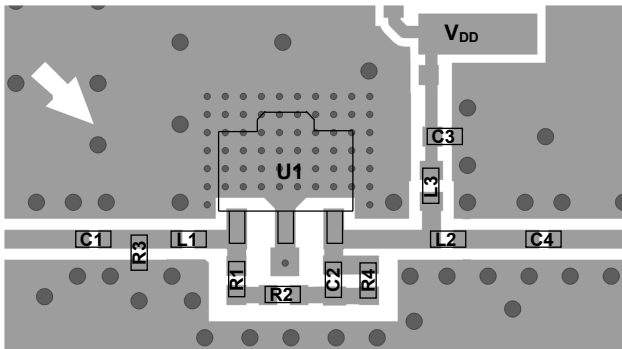

The bias current can be adjusted to support lower noise figure and lower power consumption by removing external bias resistor R4 and replacing R3 as detailed below.

I_{DD}	R3 Value	Package
55 mA	Do Not Install	0402
40 mA	75 k Ω	0402
30 mA	39 k Ω	0402
20 mA	27 k Ω	0402

Recommended PCB Land Pattern

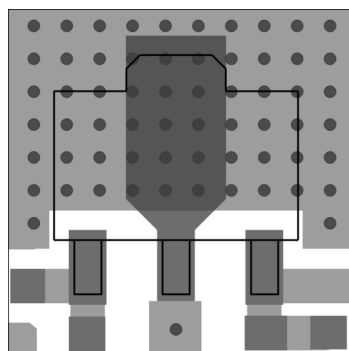

62 vias beneath package
0.012 in. via diameter

Low Noise Amplifier 5 - 4000 MHz

Rev. V2

Typical Performance Curves: $V_{DD} = 5\text{ V}$, 85 mA , $+25^\circ\text{C}$, $Z_0 = 75\ \Omega$, 45 - 1218 MHz

Gain

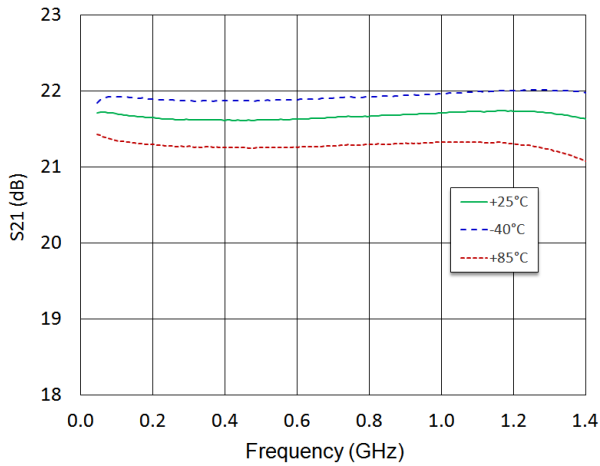

Noise Figure

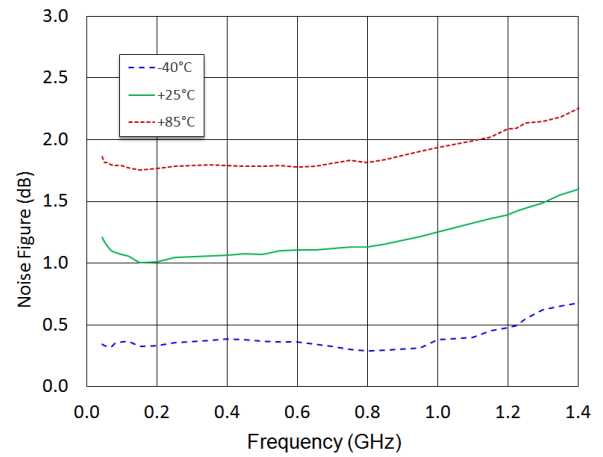

Input Return Loss

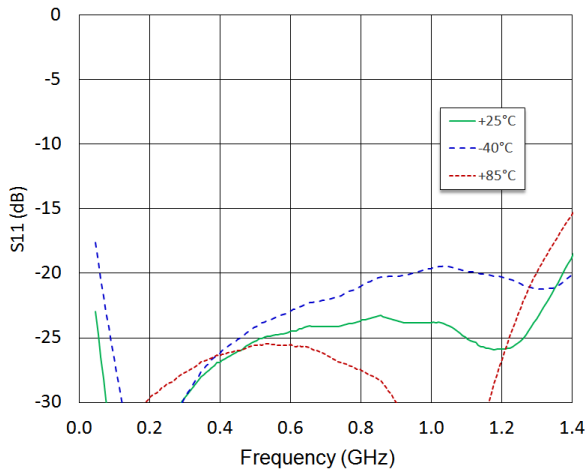

Output Return Loss

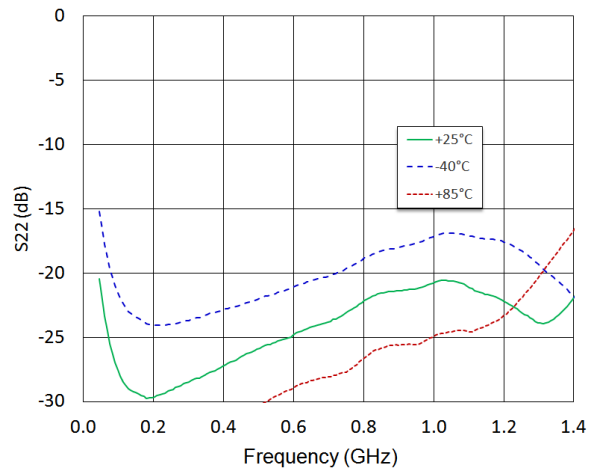

Gain to 3 GHz

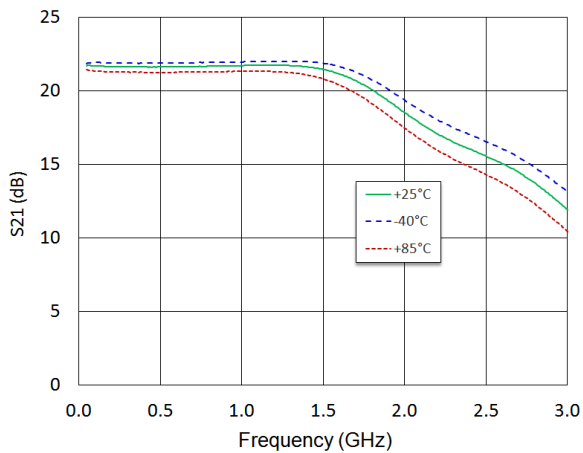

Reverse Isolation

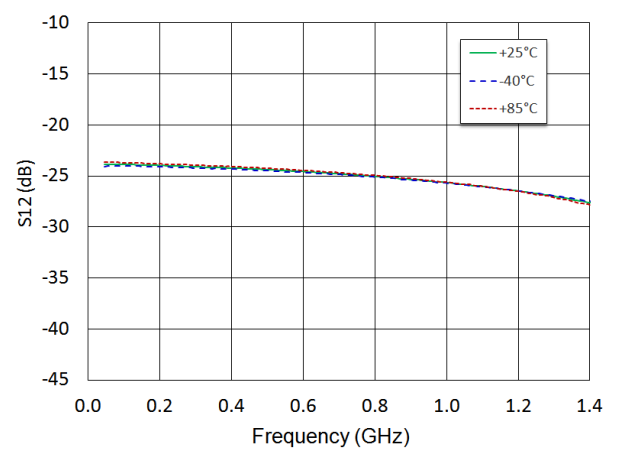

Low Noise Amplifier 5 - 4000 MHz

Rev. V2

Typical Performance Curves: $V_{DD} = 5\text{ V}$, 85 mA , $+25^\circ\text{C}$, $Z_0 = 75\ \Omega$, 45 - 1218 MHz

OIP3, $P_{OUT} = 0\text{ dBm/tone}$

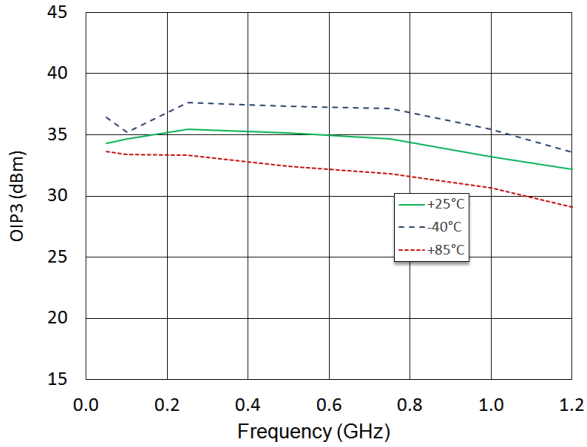

OIP2, $P_{OUT} = 0\text{ dBm/tone}$

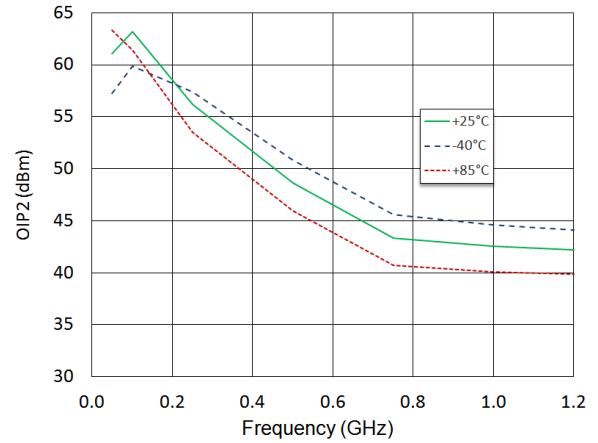

CSO Lower, 79 channels + QAM to 1 GHz, 0 dB tilt, 32 dBmV per channel

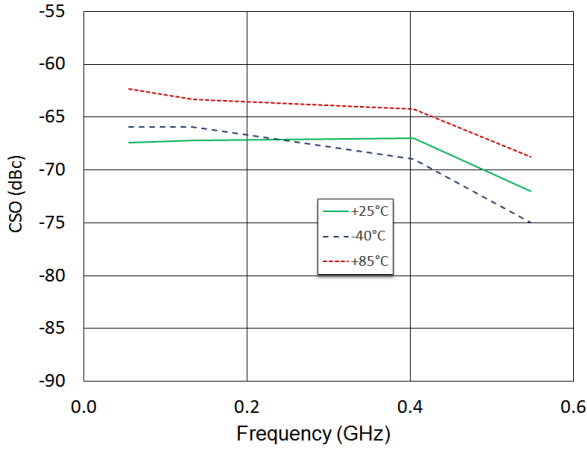

CSO Lower, 79 channels + QAM to 1 GHz, 0 dB tilt, 32 dBmV per channel

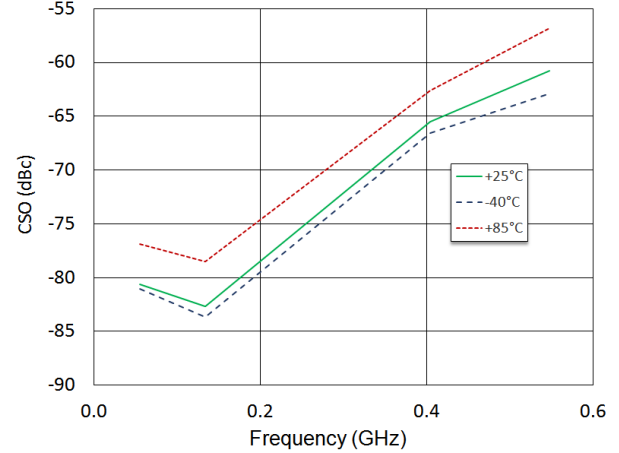

CTB Lower, 79 channels + QAM to 1 GHz, 0 dB tilt, 32 dBmV per channel

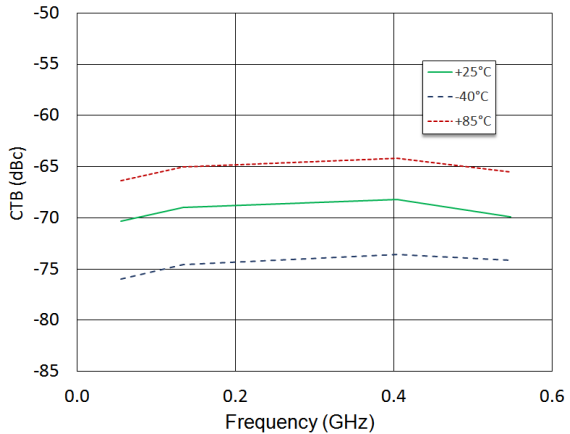

P1dB

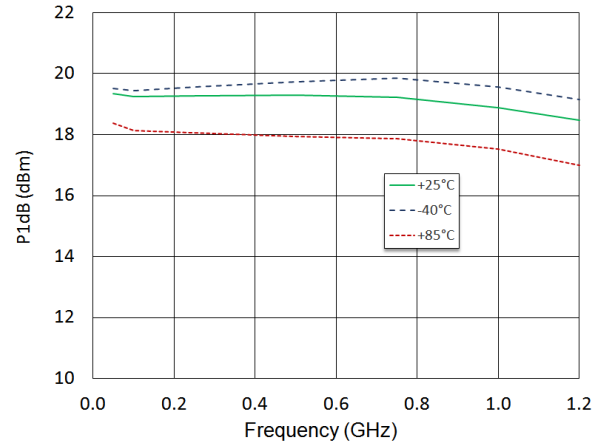

Lead Free SOT-89[†]

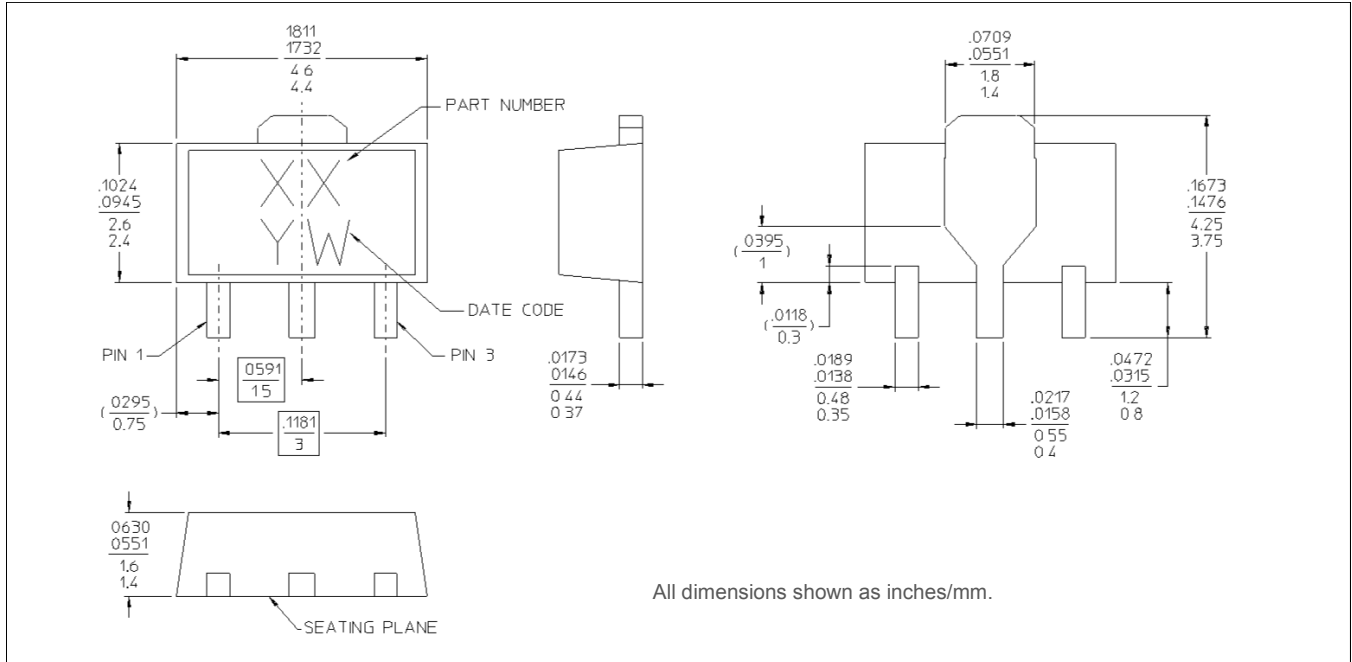

[†] Reference Application Note S2083 for lead-free solder reflow recommendations.
Meets JEDEC moisture sensitivity level 1 requirements.
Plating is 100% matte tin over copper.

Low Current and Low Noise Application Section

The MAAL-011139 can also be operated with lower current to support lower noise figure by removing 2 bias resistors, R3 and R4, as detailed below.

Schematic Including Off-Chip Components 45 - 1218 MHz Application

Parts List, $V_{DD} = 5\text{ V}$, 55 mA

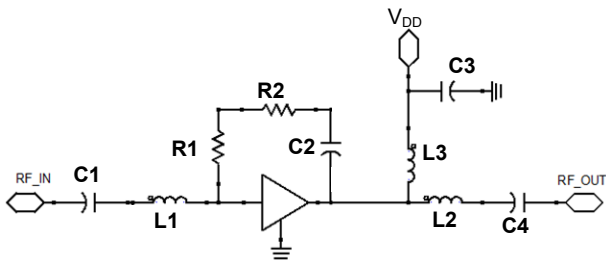

Component	Value	Package
C1 - C3	10 nF	0402
C4	270 pF	0402
L1	6.2 nH	0402
L2	3.3 nH	0402
L3	Ferrite Bead ⁸	0402
R1 - R2	510 Ω	0402

8. Murata, part number BLM15HD182SN.

Recommended PCB Layout

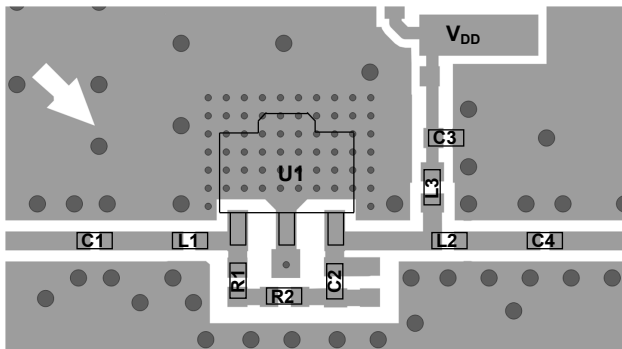

Low Current and Low Noise Application Section

Typical Performance: $T_A = 25^\circ\text{C}$, $V_{DD} = 5\text{ V}$, 55 mA , $Z_0 = 75\ \Omega$, 45 - 1218 MHz Application

Parameter	Test Conditions	Units	Min.	Typ.	Max.
Gain	—	dB	—	21.5	—
Gain Flatness	—	dB	—	+/- 0.2	—
Reverse Isolation	—	dB	—	25	—
Input Return Loss	—	dB	—	23	—
Output Return Loss	—	dB	—	23	—
Noise Figure	45 MHz 1218 MHz	dB	—	1.0 1.2	—
Output IP2	45 - 1200 MHz, tone spacing 6 MHz, P_{OUT} per tone = 0 dBm	dBm	—	44	—
Output IP3	45 - 1200 MHz, tone spacing 6 MHz, P_{OUT} per tone = 0 dBm	dBm	—	35	—
P1dB	—	dBm	—	18	—
Composite Triple Beat, CTB	79 channels, 0 dB Tilt, 18 dBmV per channel output, QAM to 1000 MHz	dBc	—	-80	—
Composite Second Order, CSO	79 channels, 0 dB Tilt, 18 dBmV per channel output, QAM to 1000 MHz	dBc	—	-63	—
I_{DD}	—	mA	—	55	—

Low Noise Amplifier 5 - 4000 MHz

Rev. V2

Typical Performance Curves: $V_{DD} = 5\text{ V}$, 55 mA , $+25^\circ\text{C}$, $Z_0 = 75\ \Omega$, 45 - 1218 MHz

Gain

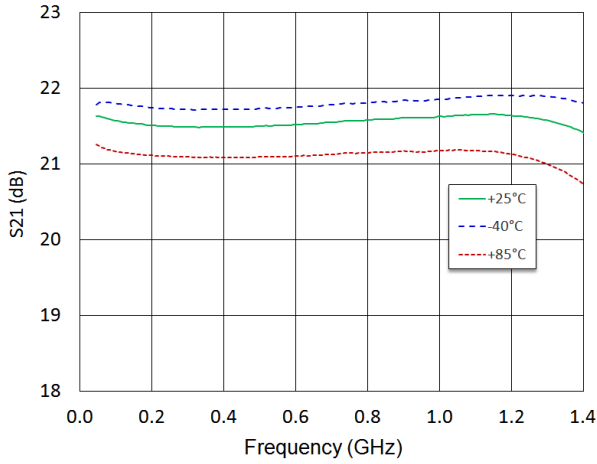

Noise Figure

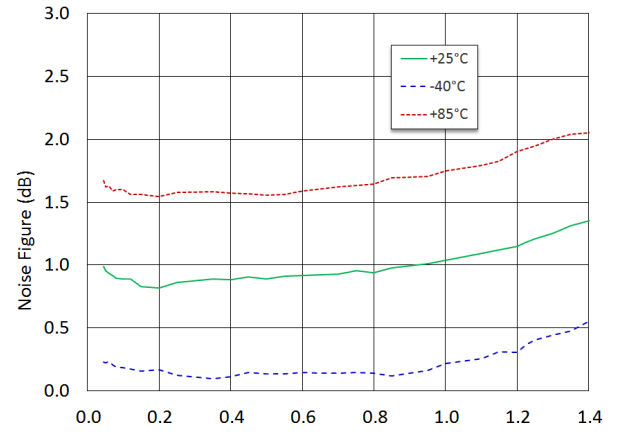

Input Return Loss

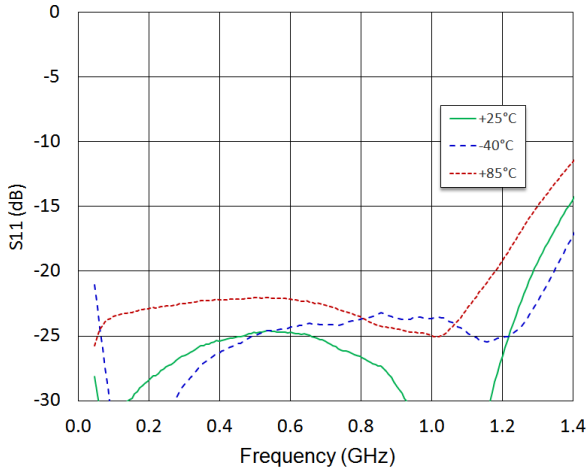

Output Return Loss

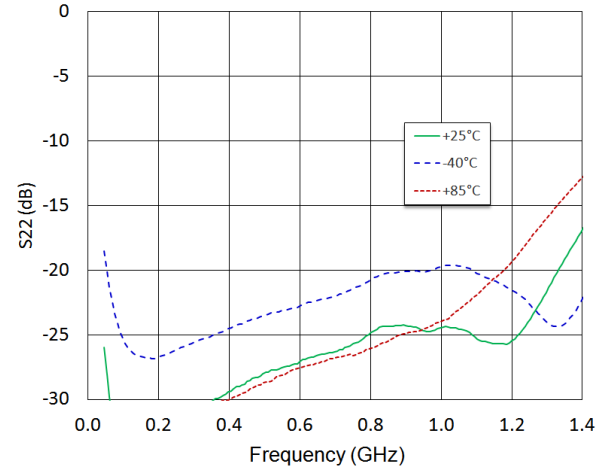

Gain to 3 GHz

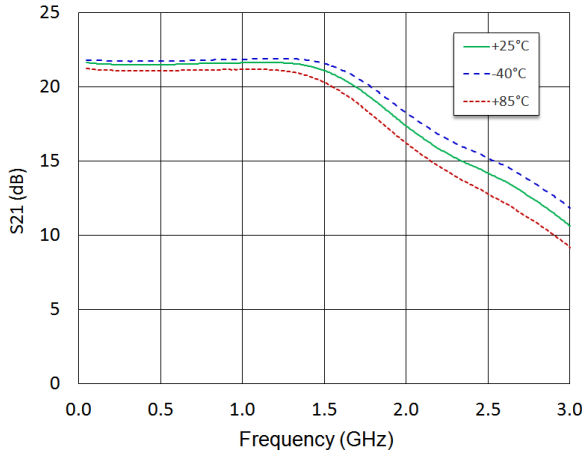

Reverse Isolation

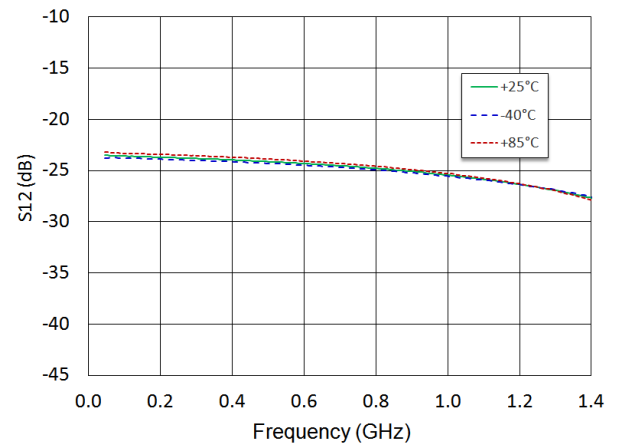

Low Noise Amplifier 5 - 4000 MHz

Rev. V2

Typical Performance Curves: $V_{DD} = 5\text{ V}$, 55 mA , $+25^\circ\text{C}$, $Z_0 = 75\ \Omega$, 45 - 1218 MHz

OIP3, $P_{OUT} = 0\text{ dBm/tone}$

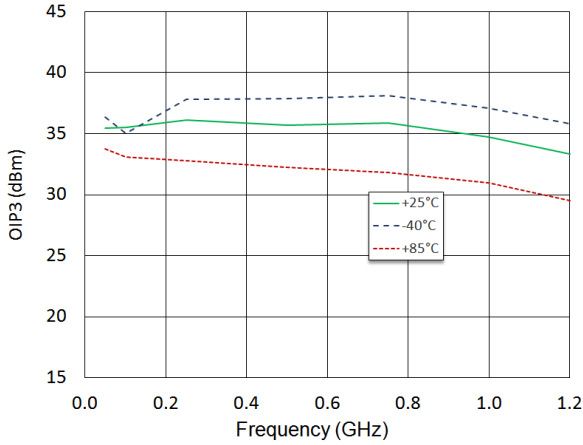

OIP2, $P_{OUT} = 0\text{ dBm/tone}$

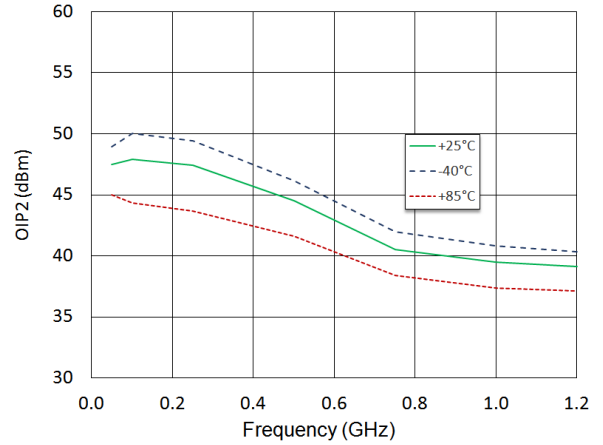

CSO Lower, 79 channels + QAM to 1 GHz, 0 dB tilt, 18 dBmV per channel

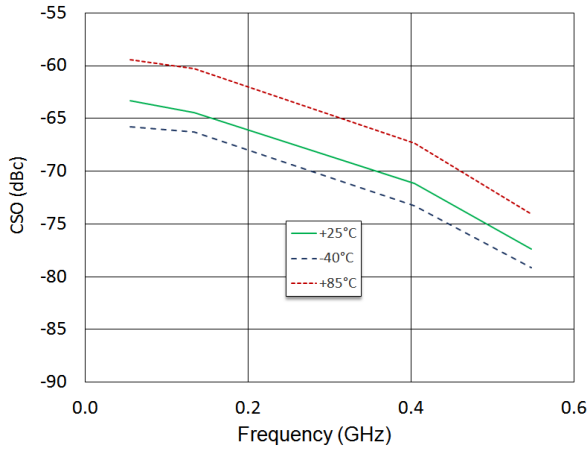

CSO Lower, 79 channels + QAM to 1 GHz, 0 dB tilt, 18 dBmV per channel

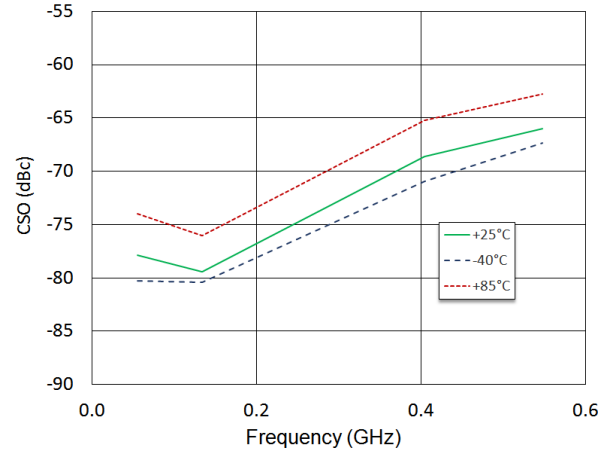

CTB Lower, 79 channels + QAM to 1 GHz, 0 dB tilt, 18 dBmV per channel

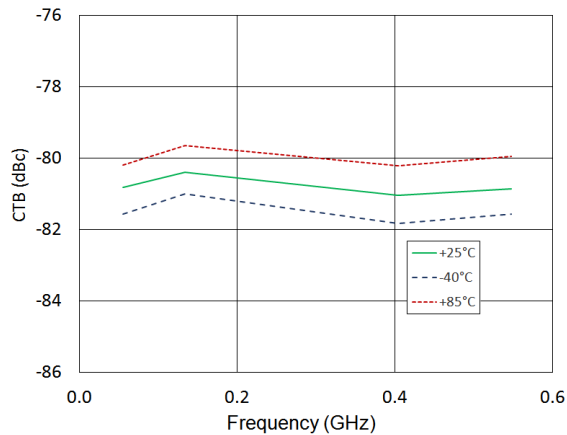

P1dB

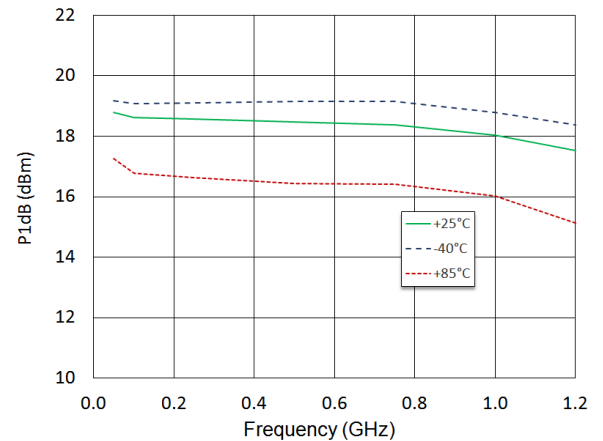

5 - 300 MHz Application Section

The MAAL-011139 can be tuned for operation in the 5 - 300 MHz band for CATV reverse path (upstream) applications using alternate external tuning components.

Typical Performance: $T_A = 25^\circ\text{C}$, $V_{DD} = 5\text{ V}$, 85 mA , $Z_0 = 75\ \Omega$, 5 - 300 MHz Application

Parameter	Test Conditions	Units	Min.	Typ.	Max.
Gain	—	dB	—	21.6	—
Gain Flatness	—	dB	—	+/- 0.2	—
Reverse Isolation	—	dB	—	25	—
Input Return Loss	—	dB	—	25	—
Output Return Loss	—	dB	—	22	—
Noise Figure	10 - 50 MHz 50 - 300 MHz	dB	—	3.1 1.2	—
Output IP2	5 - 300 MHz, tone spacing 6 MHz, P_{OUT} per tone = 0 dBm	dBm	—	55	—
Output IP3	5 - 300 MHz, tone spacing 6 MHz, P_{OUT} per tone = 0 dBm	dBm	—	34	—
P1dB	—	dBm	—	19	—
Noise Power Ratio	5 - 85 MHz, 41 MHz Notch, Peak NPR 5 - 204 MHz, 100 MHz Notch, Peak NPR	dB	—	65 61	—
I_{DD}	—	mA	—	85	—

Recommended PCB Layout 5 - 300 MHz Application

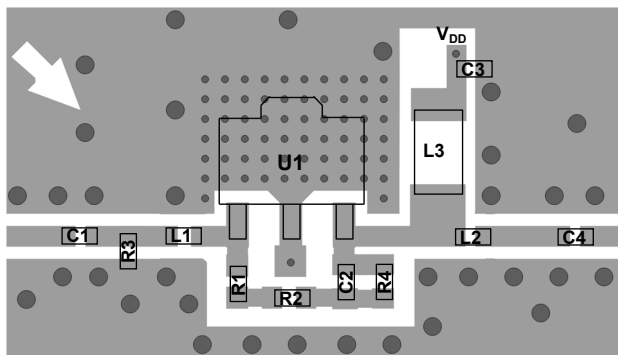

Parts List, $V_{DD} = 5\text{ V}$, 85 mA

Component	Value	Package
C1 - C3	10 nF	0402
C4	2200 pF	0402
L1	0 Ω	0402
L2	6.8 nH	0402
L3	22 μH^9	0806
R1 - R2	510 Ω	0402
R3	10 k Ω	0402
R4	30.1 k Ω	0402

9. Inductor from Murata, part number LQH2MCN220K02.

Low Noise Amplifier 5 - 4000 MHz

Rev. V2

Typical Performance Curves: $V_{DD} = 5\text{ V}$, 85 mA , $+25^\circ\text{C}$, $Z_0 = 75\ \Omega$, 5 - 300 MHz

Gain

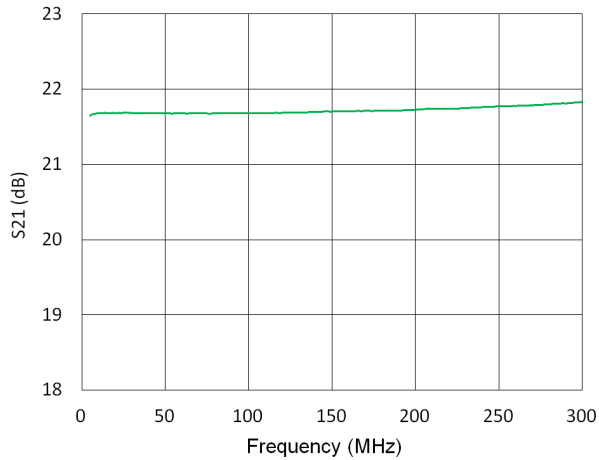

Noise Figure, 10 - 300 MHz

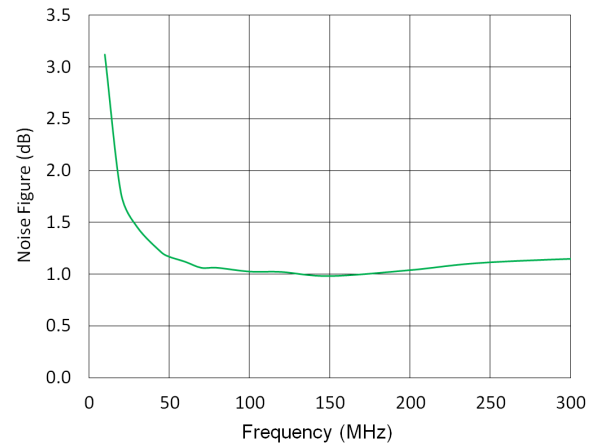

Input Return Loss

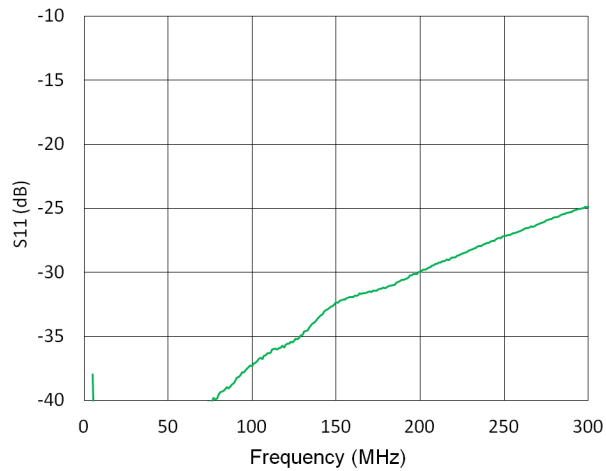

Output Return Loss

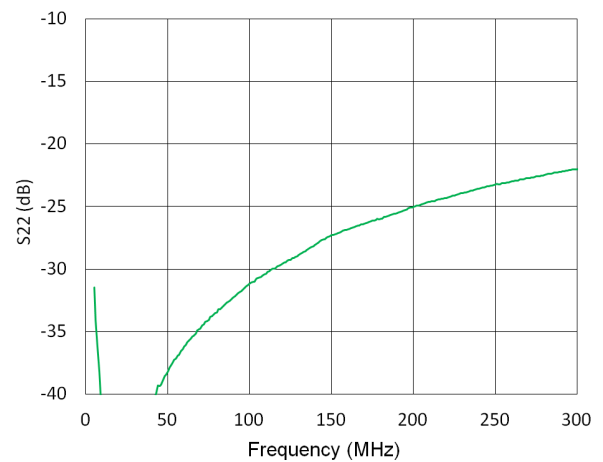

OIP3, $P_{OUT} = 0\text{ dBm/tone}$

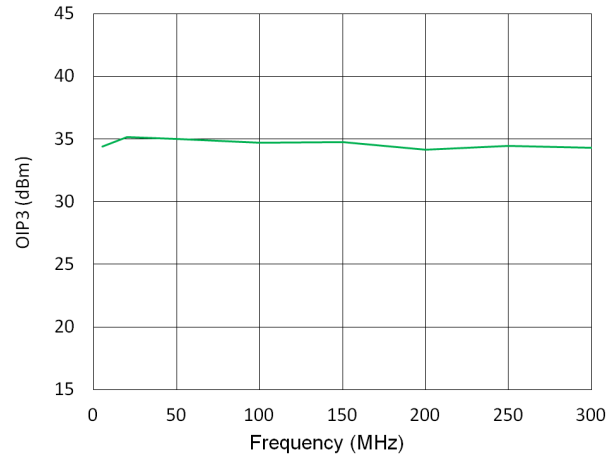

NPR

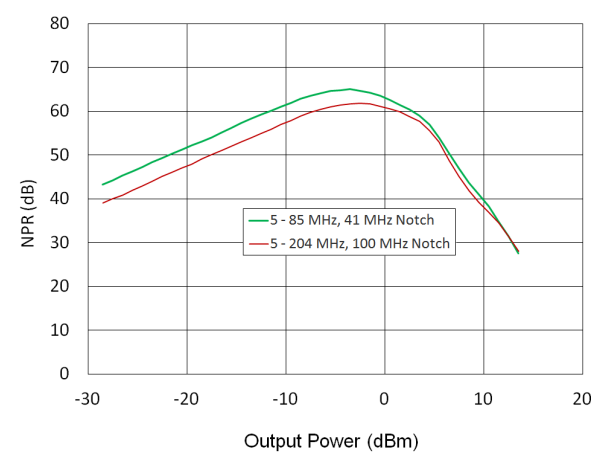

5 - 700 MHz Full Duplex Application Section

The MAAL-011139 can be tuned for operation in the 5-700 MHz band for CATV Full Duplex applications using alternate external tuning components.

Typical Performance: $T_A = 25^\circ\text{C}$, $V_{DD} = 5\text{ V}$, 55 mA , $Z_0 = 75\ \Omega$, 5 - 700 MHz Application

Parameter	Test Conditions	Units	Min.	Typ.	Max.
Gain	—	dB	—	21.3	—
Gain Flatness	—	dB	—	+/- 0.3	—
Reverse Isolation	—	dB	—	23	—
Input Return Loss	—	dB	—	22	—
Output Return Loss	—	dB	—	20	—
Noise Figure	10 - 50 MHz 50 - 700 MHz	dB	—	2.5 1.0	—
Output IP2	5 - 700 MHz, tone spacing 6 MHz, P_{OUT} per tone = -10 dBm	dBm	—	44	—
Output IP3	5 - 700 MHz, tone spacing 6 MHz, P_{OUT} per tone = -10 dBm	dBm	—	35	—
P1dB	—	dBm	—	18	—
Noise Power Ratio	5 - 204 MHz, 100 MHz Notch, Peak NPR	dB	—	54	—
I_{DD}	—	mA	—	55	—

Recommended PCB Layout 5 - 700 MHz Application

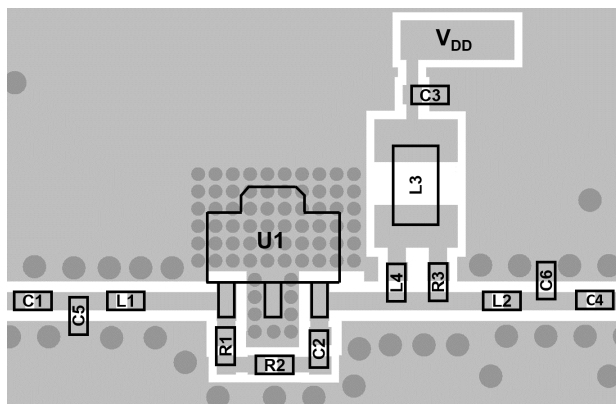

Parts List, $V_{DD} = 5\text{ V}$, 55 mA

Component	Value	Package
C1 - C3	10 nF	0402
C4	2200 pF	0402
L1	0 Ω	0402
L2	6.8 nH	0402
L3	22 μH^{10}	0806
L4	Ferrite Bead ¹¹	0402
R1 - R2	510 Ω	0402
R3	1.2 k Ω	0402

10. Murata Inductor, part number LQH2MCN220K02.
11. Murata Ferrite Bead, part number BLM15HD182SN.

Low Noise Amplifier 5 - 4000 MHz

Rev. V2

Typical Performance Curves: $V_{DD} = 5\text{ V}$, 55 mA , $+25^\circ\text{C}$, $Z_0 = 75\ \Omega$, 5 - 700 MHz

Gain

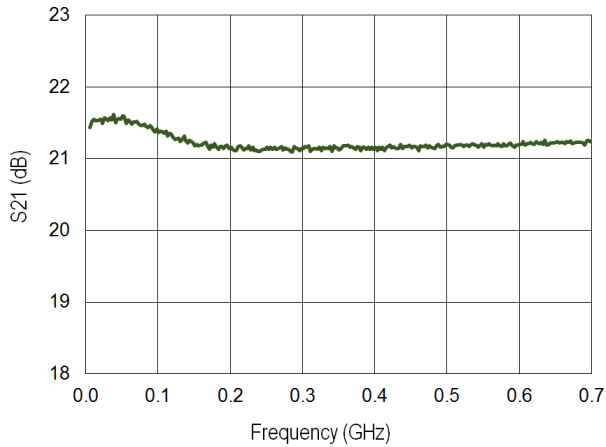

Noise Figure, 10 - 700 MHz

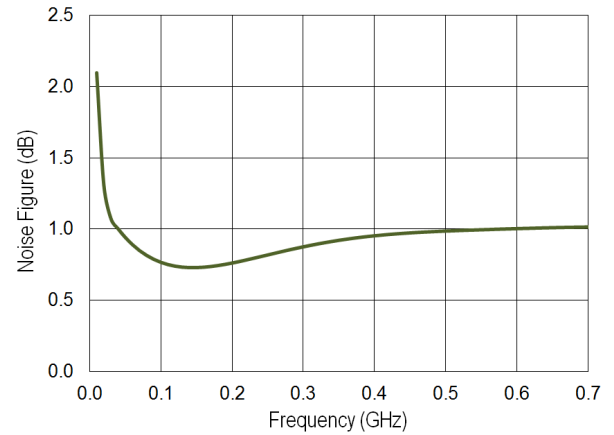

Input Return Loss

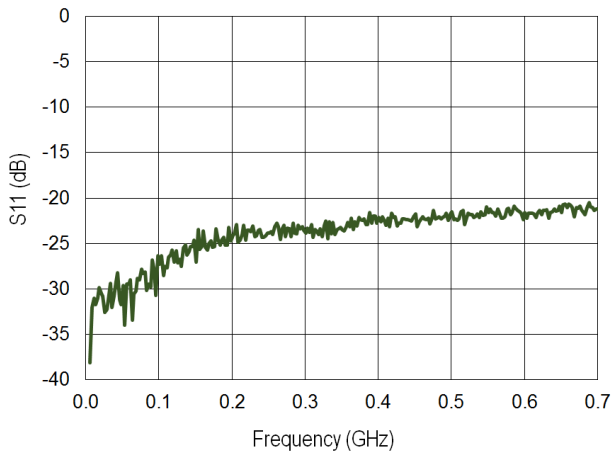

Output Return Loss

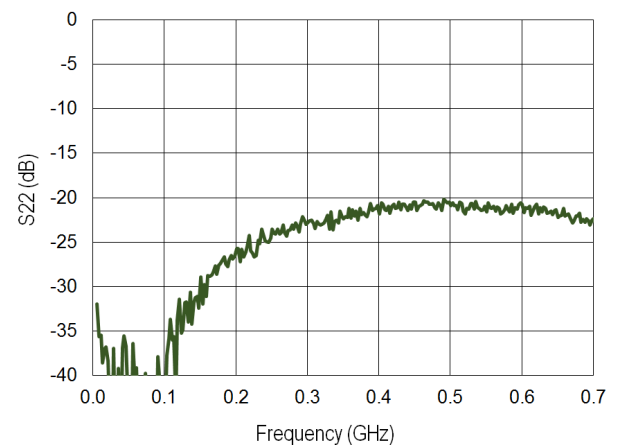

Reverse Isolation

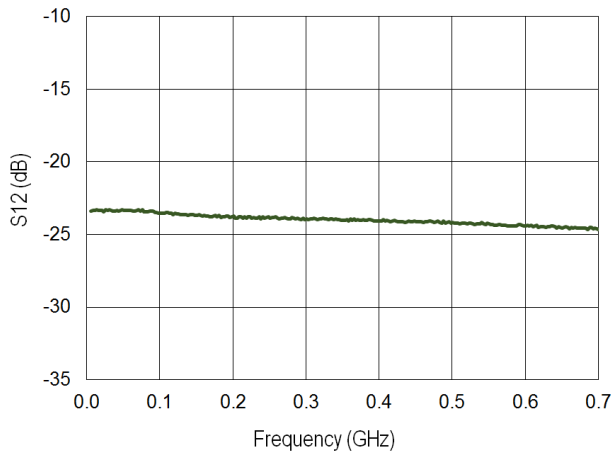

P1dB

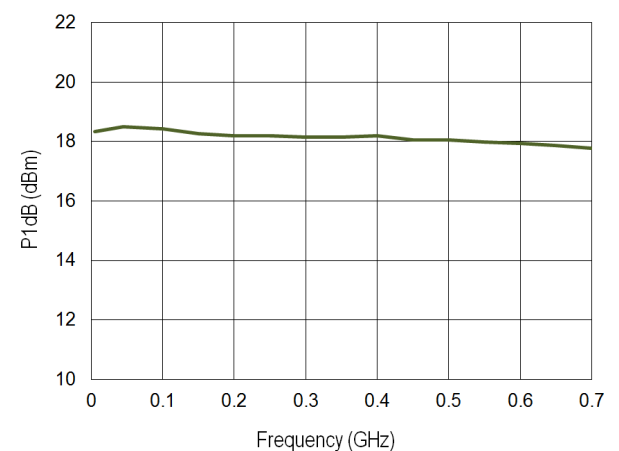

Low Noise Amplifier 5 - 4000 MHz

Rev. V2

Typical Performance Curves: $V_{DD} = 5\text{ V}$, 55 mA , $+25^\circ\text{C}$, $Z_0 = 75\ \Omega$, 5 - 700 MHz

OIP3, $P_{OUT} = -10\text{ dBm/tone}$

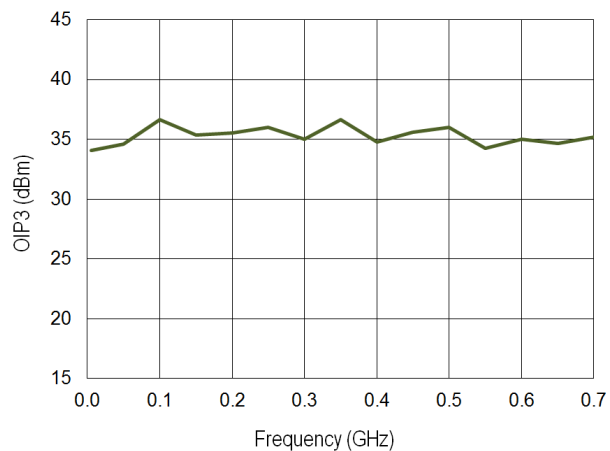

OIP2, $P_{OUT} = -10\text{ dBm/tone}$

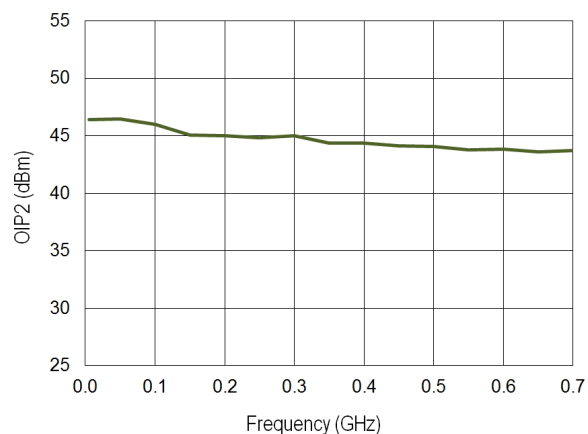

NPR

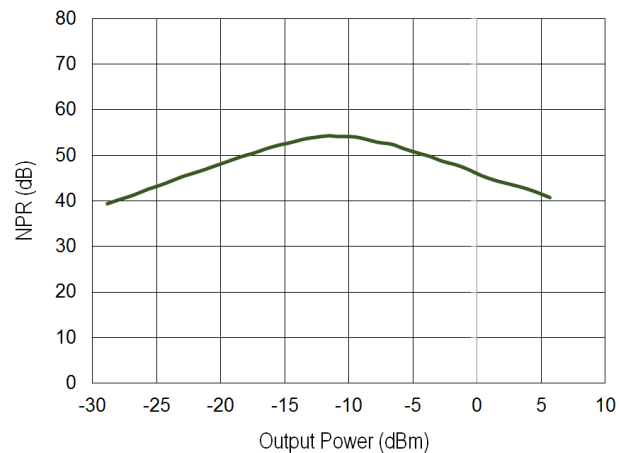

50 Ω System Application Section

The MAAL-011139 can be used for 50 Ω system by using a 50 Ω evaluation board and alternate external tuning components.

Typical Performance: $T_A = 25^\circ\text{C}$, $V_{DD} = 5\text{ V}$, 55 mA , $Z_0 = 50\ \Omega$, 45 - 2000 MHz Application

Parameter	Test Conditions	Units	Min.	Typ.	Max.
Gain	—	dB	—	17	—
Gain Flatness	—	dB	—	+/- 0.2	—
Reverse Isolation	—	dB	—	19	—
Input Return Loss	—	dB	—	15	—
Output Return Loss	—	dB	—	17	—
Noise Figure	45 MHz 2000 MHz	dB	—	1.5 1.8	—
Output IP2	45 - 2000 MHz, tone spacing 6 MHz, P_{OUT} per tone = 0 dBm	dBm	—	40	—
Output IP3	45 - 2000 MHz, tone spacing 6 MHz, P_{OUT} per tone = 0 dBm	dBm	—	32	—
P1dB	—	dBm	—	16.5	—
I_{DD}	—	mA	—	55	—

Recommended PCB Layout 50 Ω, 45 - 2000 MHz Application

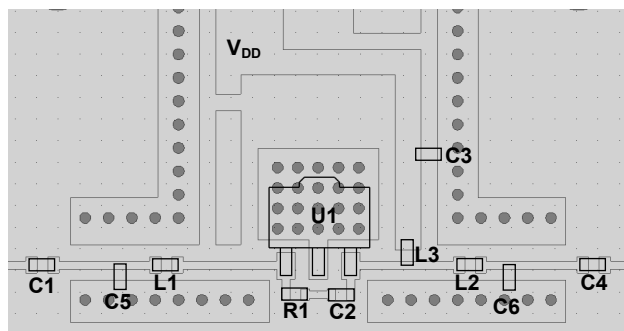

Parts List, $V_{DD} = 5\text{ V}$, 55 mA

Component	Value	Package
C1 - C3	10 nF	0402
C4	220 pF	0402
C5	0.7 pF	0402
C6	0.5 pF	0402
L1 - L2	3.3 nH	0402
L3	Ferrite Bead ¹²	0402
R1	430 Ω	0402

12. Murata, part number BLM15HD182SN.

Low Noise Amplifier 5 - 4000 MHz

Rev. V2

Typical Performance Curves: $V_{DD} = 5\text{ V}$, 55 mA , $+25^\circ\text{C}$, $Z_0 = 50\ \Omega$, 45 - 2000 MHz

Gain

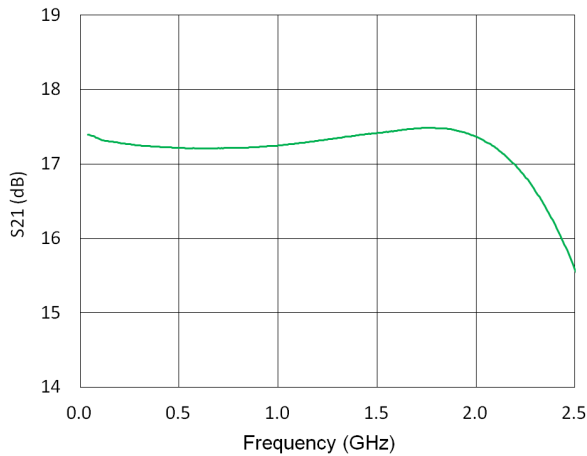

Gain to 4 GHz

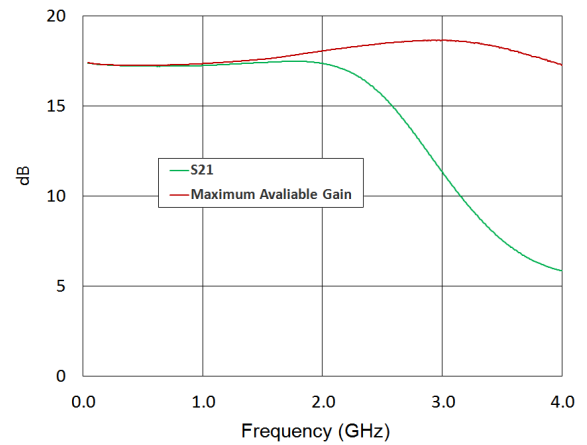

Input & Output Return Losses

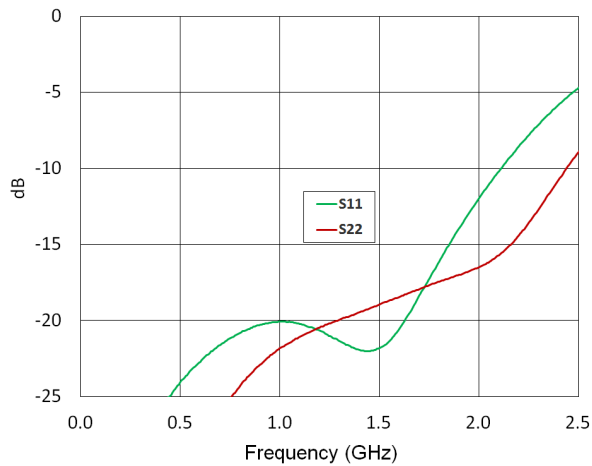

Noise Figure

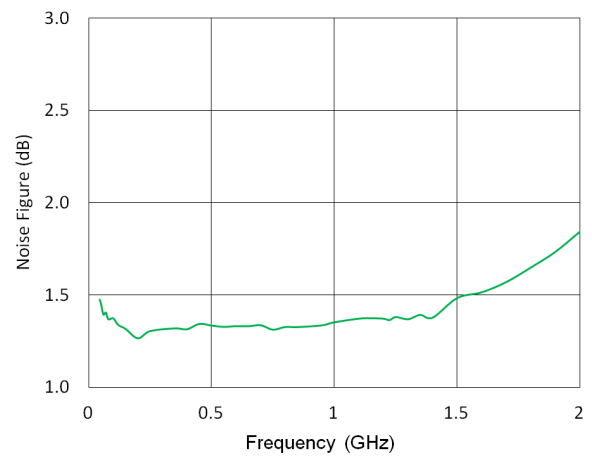

OIP3, $P_{OUT} = 0\text{ dBm/tone}$

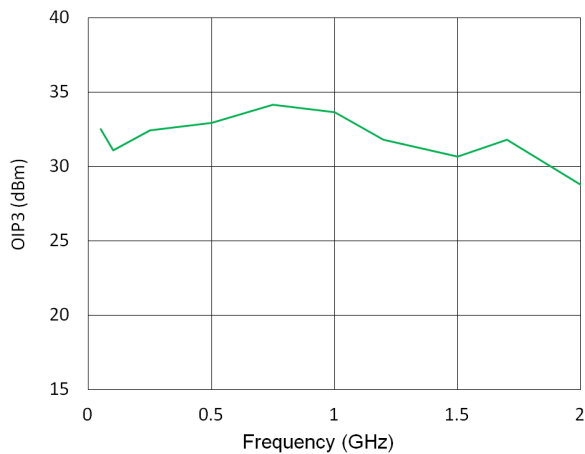

OIP2, $P_{OUT} = 0\text{ dBm/tone}$

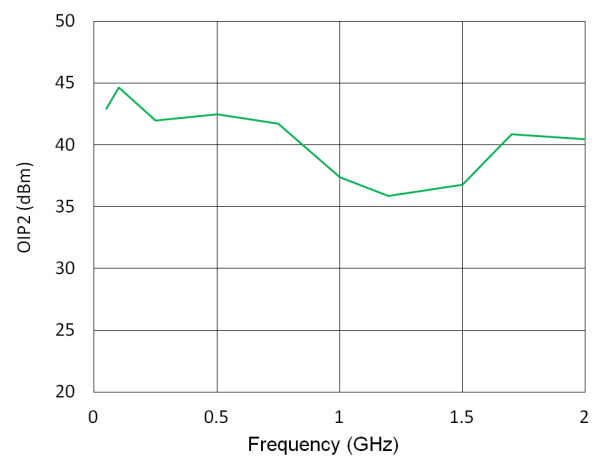

MACOM Technology Solutions Inc. All rights reserved.

Information in this document is provided in connection with MACOM Technology Solutions Inc ("MACOM") products. These materials are provided by MACOM as a service to its customers and may be used for informational purposes only. Except as provided in MACOM's Terms and Conditions of Sale for such products or in any separate agreement related to this document, MACOM assumes no liability whatsoever. MACOM assumes no responsibility for errors or omissions in these materials. MACOM may make changes to specifications and product descriptions at any time, without notice. MACOM makes no commitment to update the information and shall have no responsibility whatsoever for conflicts or incompatibilities arising from future changes to its specifications and product descriptions. No license, express or implied, by estoppel or otherwise, to any intellectual property rights is granted by this document.

THESE MATERIALS ARE PROVIDED "AS IS" WITHOUT WARRANTY OF ANY KIND, EITHER EXPRESS OR IMPLIED, RELATING TO SALE AND/OR USE OF MACOM PRODUCTS INCLUDING LIABILITY OR WARRANTIES RELATING TO FITNESS FOR A PARTICULAR PURPOSE, CONSEQUENTIAL OR INCIDENTAL DAMAGES, MERCHANTABILITY, OR INFRINGEMENT OF ANY PATENT, COPYRIGHT OR OTHER INTELLECTUAL PROPERTY RIGHT. MACOM FURTHER DOES NOT WARRANT THE ACCURACY OR COMPLETENESS OF THE INFORMATION, TEXT, GRAPHICS OR OTHER ITEMS CONTAINED WITHIN THESE MATERIALS. MACOM SHALL NOT BE LIABLE FOR ANY SPECIAL, INDIRECT, INCIDENTAL, OR CONSEQUENTIAL DAMAGES, INCLUDING WITHOUT LIMITATION, LOST REVENUES OR LOST PROFITS, WHICH MAY RESULT FROM THE USE OF THESE MATERIALS.

MACOM products are not intended for use in medical, lifesaving or life sustaining applications. MACOM customers using or selling MACOM products for use in such applications do so at their own risk and agree to fully indemnify MACOM for any damages resulting from such improper use or sale.

X-ON Electronics

Largest Supplier of Electrical and Electronic Components

Click to view similar products for [RF Amplifier](#) category:

Click to view products by [MACOM](#) manufacturer:

Other Similar products are found below :

[A82-1](#) [BGA622H6820XTSA1](#) [BGA 728L7 E6327](#) [BGB719N7ESDE6327XTMA1](#) [HMC397-SX](#) [HMC405](#) [HMC561-SX](#) [HMC8120-SX](#)
[HMC8121-SX](#) [HMC-ALH382-SX](#) [HMC-ALH476-SX](#) [SE2433T-R](#) [SMA3101-TL-E](#) [SMA39](#) [A66-1](#) [A66-3](#) [A67-1](#) [LX5535LQ](#) [LX5540LL](#)
[MAAM02350](#) [HMC3653LP3BETR](#) [HMC549MS8GETR](#) [HMC-ALH435-SX](#) [SMA101](#) [SMA32](#) [SMA411](#) [SMA531](#) [SST12LP17E-XX8E](#)
[SST12LP19E-QX6E](#) [WPM0510A](#) [HMC5929LS6TR](#) [HMC5879LS7TR](#) [HMC1126](#) [HMC1087F10](#) [HMC1086](#) [HMC1016](#) [SMA1212](#)
[MAX2689EWS+T](#) [MAAMSS0041TR](#) [MAAM37000-A1G](#) [LTC6430AIUF-15#PBF](#) [CHA5115-QDG](#) [SMA70-2](#) [SMA4011](#) [A231](#) [HMC-](#)
[AUH232](#) [LX5511LQ](#) [LX5511LQ-TR](#) [HMC7441-SX](#) [HMC-ALH310](#)