

Wideband Amplifier (WBA)

Advanced

DC – 40GHz

Rev.V1B Apr 2014

Features

- 15 dB Typical Gain
- 50 Ω match in and out
- +20 dBm output power
- +5V DC supply, 190mA
- Bare Die
- RoHS Complaint and 260 °C Reflow

Description

The MAAM-011109-000DIE is a easy-to-use, GaAs MMIC distributed amplifier for applications between DC and 40 GHz and features 15 dB typical gain and +20dBm of output power. Matching is 50 Ω with typical return loss better than 15 dB. The WBA requires dual DC supplies: 5V (190 mA typical) and a low current negative VG1 (< 1mA).

Some other features include: a gain trim control pin that allows 15 dB of gain control (0 to -1V), and a temperature compensated detector pin that provides a DC voltage in relation to output power.

Typical usage is any application that requires 50 Ω gain from DC to 40GHz. It is useful in application where the incoming signal varies over a broad bandwidth such as a laboratory, instrumentation, and defense applications.

The WBA is a 2.05 x 1.38 mm bare die GaAs MMIC that can be handled and placed with standard pick and place assembly equipment. The GaAs MMIC is fully passivated for performance and reliability.

* Restrictions on Hazardous Substances, European Union Directive 2001/95/EC

Functional Schematic

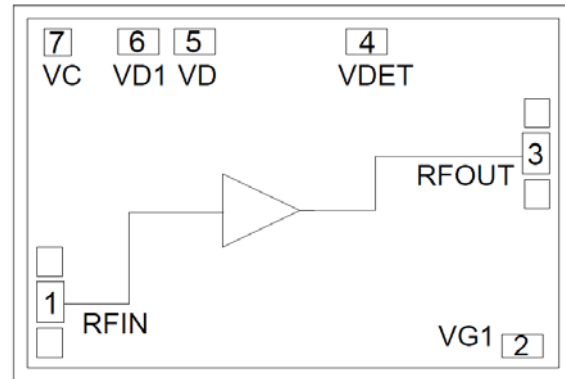

Pin Configuration

PIN No.	Pin Name	Description
1	RF _{IN}	RF input
2	V _{G1}	Gate Voltage (negative)
3	RF _{OUT}	RF output
6	V _{DET}	Power detector
7	V _D	Termination Bypass (alternate supply current)
8	V _{D1}	Termination Bypass
9	V _C	Gain Control

Ordering Information

Part Number	Package
MAAM-011109-000DIE	Bare Die

Wideband Amplifier (WBA)

Advanced

DC – 40GHz

Rev.V1B Apr 2014

Electrical Specifications $T_A = 25^\circ\text{C}$, $R_{FOUT} = +5\text{V}$, $I_{RFOUT} = 190\text{mA}$, $Z_{in} = Z_{out} = 50\Omega$ unless otherwise specified

Parameter	Test Conditions	Units	Min.	Typ.	Max.
Gain		0.1 GHz	dB	15	
		10 GHz		16	
		40 GHz		15	
NF	DC to 40 GHz	dB		3.5	
P-1dB	Vd=5V	0.1 GHz	dBm	+21	
		10 GHz		+21	
		40 GHz		+15	
Output P _{SAT}		0.1 GHz	dBm	+24	
		10 GHz		+23	
		40 GHz		+20	
Input Return Loss	DC to 40 GHz	dB		15	
Output Return Loss	DC to 40 GHz	dB		12	
Isolation	0.03 to 40GHz	dB		22	
Stability	Any load			unconditional	
Voltage Supply		V		5	
Bias Current	$R_{FOUT} = 5\text{V}$, $V_{G1} = -0.4\text{V}$	mA		190	

Absolute Maximum Ratings ^{4,5,6,7}

Parameter	Absolute Maximum
Input Power	+17 dBm
Operating Voltage	+ 8 V
Operating Current	+230mA
Thermal Resistance Θ_{jc}	14 °C /W
Operating Temperature	-40°C to +85 °C
Junction Temperature ⁷	+ 150 °C
Storage Temperature	-65°C to +150 °C

4. Exceeding any or combination of these limits may cause permanent damage to the device

5. M/A-COM Technology Solutions does not recommend sustained operation near these survivability limits.

6. Operating at nominal conditions with $T_J \leq +150^\circ\text{C}$ will ensure $MTTF \geq 1 \times 10^6$ hours

7. Junction Temperature (T_J) = $T_c + \Theta_{jc} * ((V * I) - (P_{out} - P_{in}))$
Typical thermal resistance (Θ_{jc}) = 14 °C/W

a) For $T_c = 25^\circ\text{C}$

$T_J = 40^\circ\text{C}$ @ +5V, 190 mA, $P_{out} = -5\text{dBm}$, $P_{in} = -20\text{dBm}$

b) For $T_c = 85^\circ\text{C}$

$T_J = 100^\circ\text{C}$ @ +5V, 190 mA, $P_{out} = -5\text{dBm}$, $P_{in} = -20\text{dBm}$

Handling Procedures

Please observe the following precautions to avoid damage

Static Sensitivity

Gallium Arsenide Integrated Circuits are sensitive to electrostatic discharge (ESD) and can be damaged by static electricity. Proper ESD control techniques should be used when handling these class 0 devices

Wideband Amplifier (WBA)

Advanced

DC – 40GHz

Rev.V1B Apr 2014

Biasing Schematic

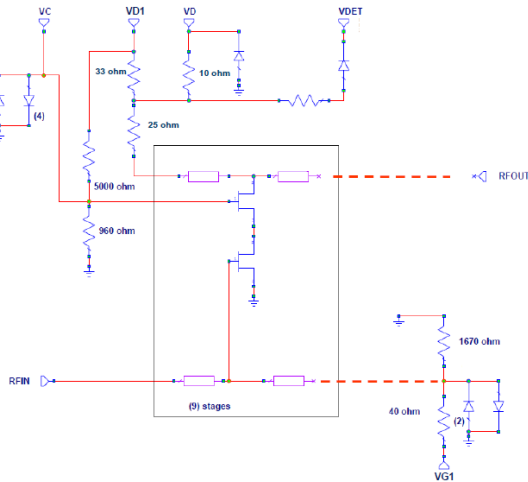

Application Information for DC & pins

For proper MAAM-011109-000DIE operation a DC voltage must be applied at the V_{G1} (-0.4v typical) and RF_{OUT} (+5V typical) pins *in that order*. Adjusting V_{G1} from -0.2v to -0.6 V will change the quiescent current.

The V_C pin is typically left unconnected unless gain control or output power limiting is desired. Please refer to the “Variable Gain/Limiting” section for detailed usage

The V_D and V_{D1} pins should be bypassed with at least 0.1 μF for stability. The V_{G1} and V_C pins must also be bypassed with a 0.1 μF . The V_D pin can be used as a alternate bias point for the die. Rather than installing a bias tee at the RF_{OUT} pin a low impedance bias source can be connected to the V_D pin. The V_D pin has a limited current capability of 100mA maximum, and as shown in the Biasing Schematic a DC voltage drop will occur so the actual transistor voltage will be $V_D - I_D * 35$. The actual transistor voltage should be in the range of 3.3 to 7v for proper operation.

The V_{DET} pin is typically left unconnected unless a voltage reference is desired that is correlated to the output power. Please refer to the “Internal Detector” section for detailed usage.

The backside of the die should be connected to ground with as many vias as possible to maximize high frequency performance, thermal dissipation, and stability.

Application Details

Bandwidth, Power, Noise and Linearity

Supply voltage and current affect both the bandwidth (response flatness), power available, noise figure, and linearity of the amplifier. Higher currents and lower supply voltage increase high frequency gain but reduce the P-1dB and the OIP3 numbers. If the device is driven to P-1dB and on into P_{sat} the supply current will naturally reduce. The device will return to the quiescent current value once the input power is reduced. Finally, higher supply current values increase the device noise figure.

Temperature also affects the bandwidth, gain and noise figure of the device. Lower temperatures increase gain and bandwidth and reduce the noise figure. Temperature has little effect on power and linearity.

Broadband Amplifier Applications

The MAAM-011109-000DIE also has a low enough noise figure to be used in instrumentation front ends and buffer applications. It also has very flat response with low group delay distortion so it can be used in pulse applications. For higher gains multiple amplifiers may be cascaded. It also makes a very good low cost optical driver capable of delivering to 8V p-p into 50 ohms.

3

ADVANCED : Data sheets contain information regarding a product M/A-COM Technology Solutions is considering for development. Performance is based on target specifications, simulated results, and/or prototype measurements. Commitment to develop is not guaranteed
PRELIMINARY : Data Sheets containing information regarding M/A-COM Technology Solutions has under development. Performance is based on engineering tests. Specifications are typical. Mechanical outline has been fixed. Engineering samples and/or test data may be available. Commitment to production in volume is not guaranteed

North America Tel: 800.356.2266 Europe Tel: +353.21.244.6400
 India Tel: +91.80.43537383 China Tel: +88.44.844.8296

Visit www.macomtech.com for additional data sheets and product information

M/A-COM Technology Solutions Inc. and its affiliates reserve the right to make changes to the product(s) or information herein without notice

Wideband Amplifier (WBA)

Advanced

DC – 40GHz

Rev.V1B Apr 2014

Typical Performance Curves

$T_A = 25^\circ\text{C}$, $R_{FOUT} = +5\text{V}$, $I_{RFOUT} = 190\text{mA}$, $Z_{in} = Z_{out} = 50\Omega$ * Lack of VD1 capacitor causes gain rise below 2GHz

Gain (S21)

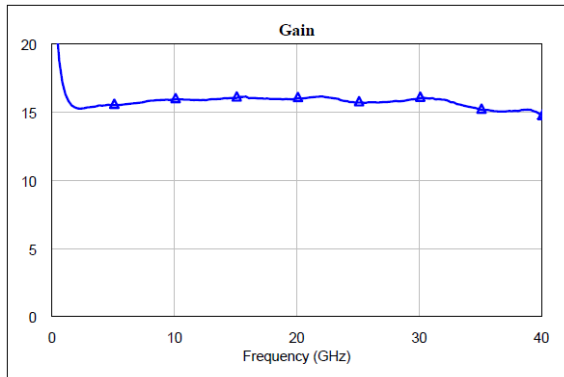

Noise Figure

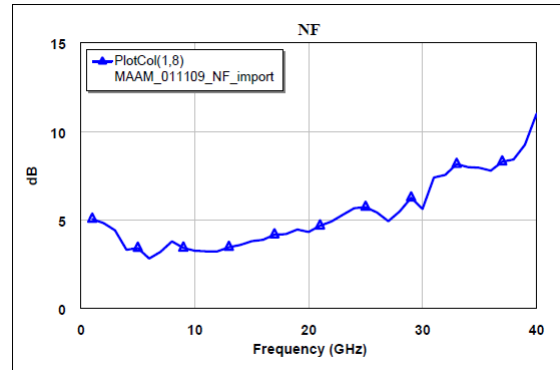

Input Reflection (S11)

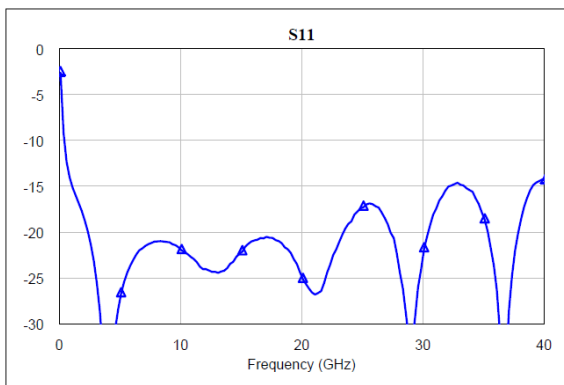

Output Reflection (S22)

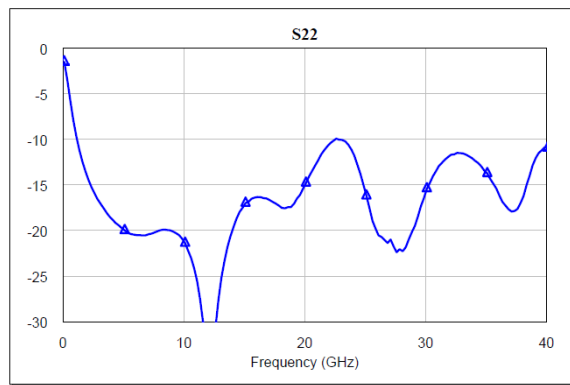

Output 1dB Compression Power

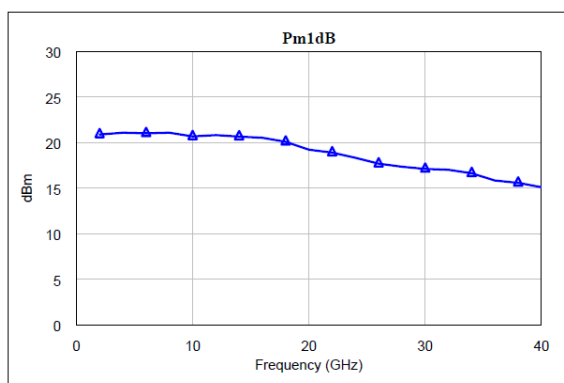

Output Power (Saturated)

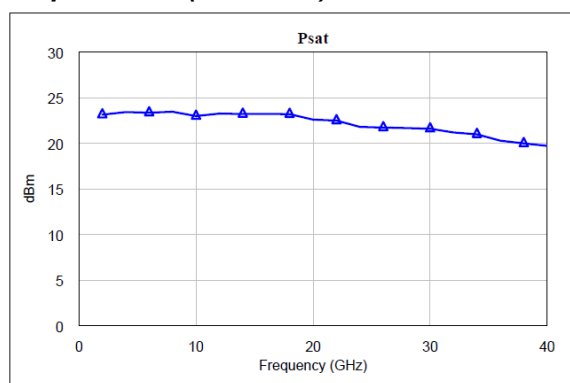

4

ADVANCED : Data sheets contain information regarding a product M/A-COM Technology Solutions is considering for development. Performance is based on target specifications, simulated results, and/or prototype measurements. Commitment to develop is not guaranteed

PRELIMINARY : Data Sheets containing information regarding M/A-COM Technology Solutions has under development. Performance is based on engineering tests. Specifications are typical. Mechanical outline has been fixed. Engineering samples and/or test data may be available. Commitment to production in volume is not guaranteed

North America Tel: 800.356.2266 Europe Tel: +353.21.244.6400
 India Tel: +91.80.43537383 China Tel: +88.44.844.8296

Visit www.macomtech.com for additional data sheets and product information

M/A-COM Technology Solutions Inc. and its affiliates reserve the right to make changes to the product(s) or information herein without notice

Wideband Amplifier (WBA)

Advanced

DC – 40GHz

Rev.V1B Apr 2014

Typical Performance Curves

$T_A = 25^\circ\text{C}$, $R_{FOUT} = +5\text{V}$, $I_{RFOUT} = 190\text{mA}$, $Z_{in} = Z_{out} = 50\Omega$ unless otherwise stated

Isolation (S12)

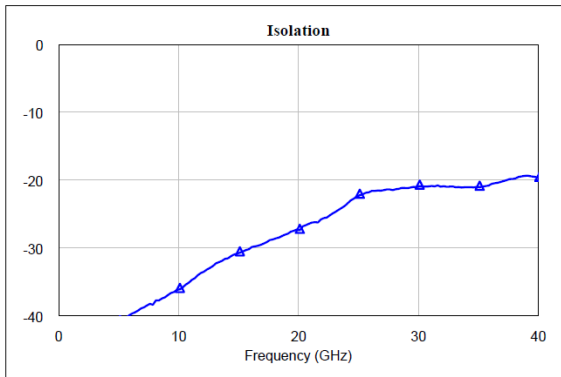

Typical I_{RFOUT} vs V_{G1}

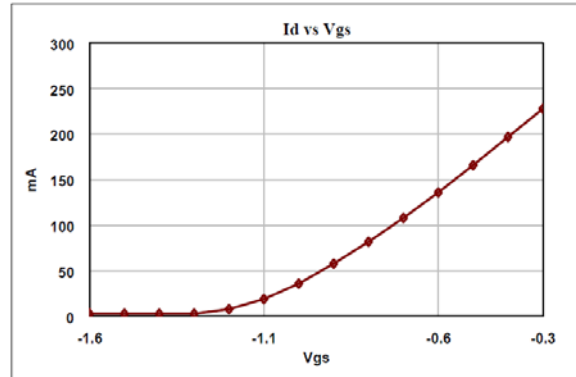

Stability Factor (K)

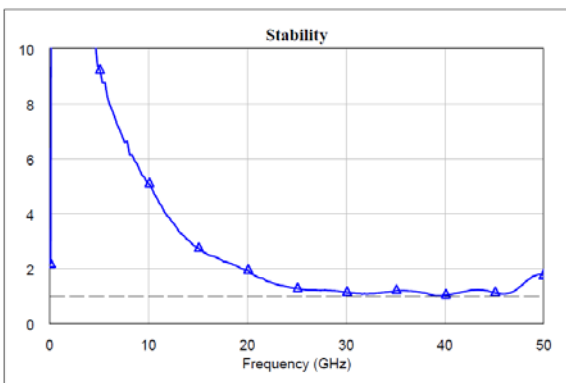

Typical I_{RFOUT} vs V_C (3.3 & 5v)

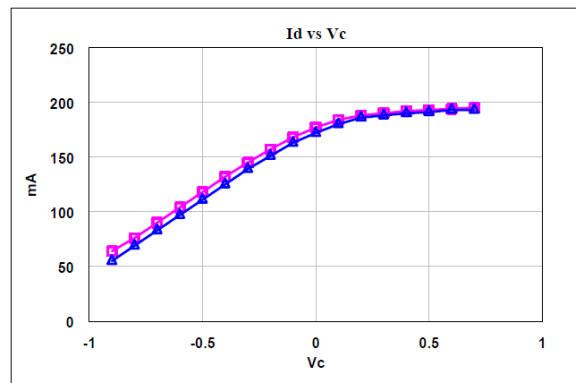

Gain(@5 GHz) vs. V_C

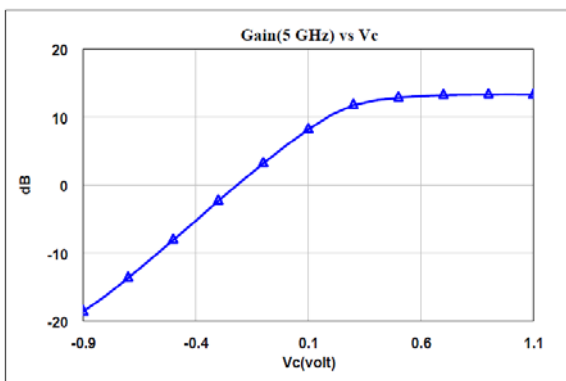

V_{DET} vs Power out @ 2GHz, 10GHz, & 25GHz

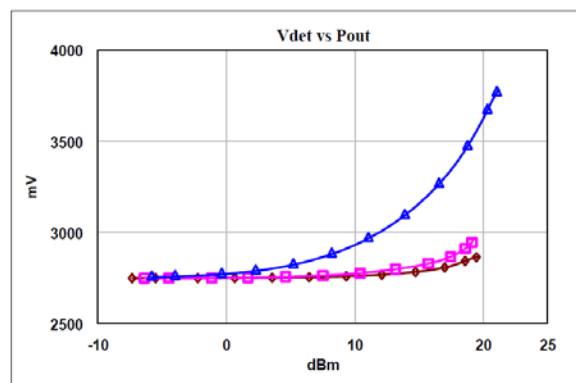

5

ADVANCED : Data sheets contain information regarding a product M/A-COM Technology Solutions is considering for development. Performance is based on target specifications, simulated results, and/or prototype measurements. Commitment to develop is not guaranteed
PRELIMINARY : Data Sheets containing information regarding M/A-COM Technology Solutions has under development. Performance is based on engineering tests. Specifications are typical. Mechanical outline has been fixed. Engineering samples and/or test data may be available. Commitment to production in volume is not guaranteed

North America Tel: 800.356.2266 Europe Tel: +353.21.244.6400
 India Tel: +91.80.43537383 China Tel: +88.44.844.8296
 Visit www.macomtech.com for additional data sheets and product information

M/A-COM Technology Solutions Inc. and its affiliates reserve the right to make changes to the product(s) or information herein without notice

Wideband Amplifier (WBA)

Advanced

DC – 40GHz

Rev.V1B Apr 2014

Outline Drawing

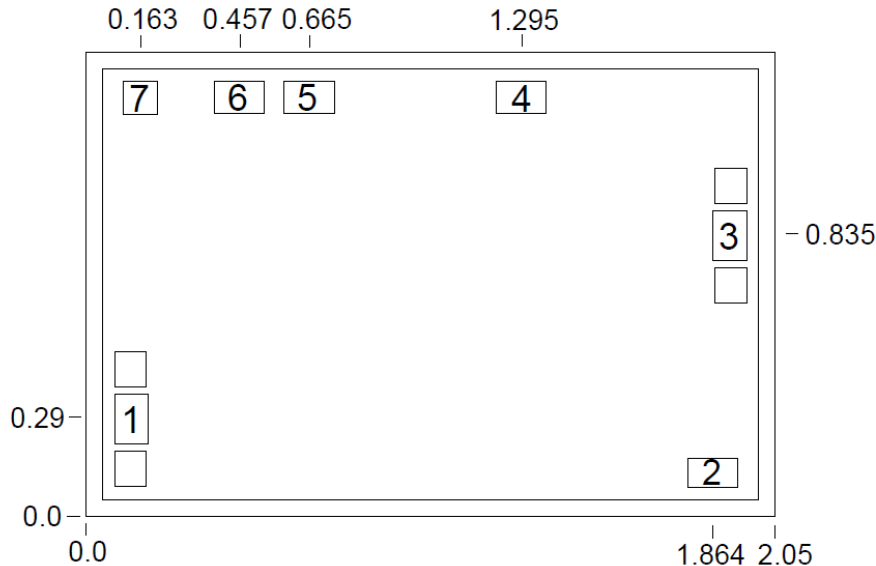

Variable Gain/Limiting Applications

The gain of the MAAM-011109-000DIE can be easily controlled with the V_c pin. The gain reduction is almost linear with V_c between 0.1V to -0.8V. Below -0.7v internal ESD protection diodes will draw increasing current (50mA at -1.0v). The V_c pin should not be driven below -1v or above 1.2v. The nominal open circuit voltage at the V_c pin is 0.8v. Reducing V_c below 0.8v will also reduce the supply current. Gain, P-1dB, and P_{sat} will all be reduced as V_c is lowered. Limiting applications and zero crossing adjustment can be done by adjusting the V_{G1} and V_c pins together.

Finally, even with zero output power the detector has a DC output voltage proportional to the supply voltage (nominally 2.8v for 5v at the R_{FOUT} pin).

Internal Detector

The V_{DET} pin is connected to an internal diode detector. This pin should be connected to a high impedance (> 50kΩ) or left unconnected. The detector is internally connected so that it responds predominately to the power generated by the amplifier. The detector has a low pass characteristic which rolls off gradually above 2 GHz. The detector is temperature compensated.

6

ADVANCED : Data sheets contain information regarding a product M/A-COM Technology Solutions is considering for development. Performance is based on target specifications, simulated results, and/or prototype measurements. Commitment to develop is not guaranteed
PRELIMINARY : Data Sheets containing information regarding M/A-COM Technology Solutions has under development. Performance is based on engineering tests. Specifications are typical. Mechanical outline has been fixed. Engineering samples and/or test data may be available. Commitment to production in volume is not guaranteed

North America Tel: 800.356.2266 Europe Tel: +353.21.244.6400
 India Tel: +91.80.43537383 China Tel: +88.44.844.8296

Visit www.macomtech.com for additional data sheets and product information

M/A-COM Technology Solutions Inc. and its affiliates reserve the right to make changes to the product(s) or information herein without notice

X-ON Electronics

Largest Supplier of Electrical and Electronic Components

Click to view similar products for [RF Amplifier](#) category:

Click to view products by [MACOM](#) manufacturer:

Other Similar products are found below :

[ADPA7006AEHZ](#) [CXE2089ZSR](#) [MGA-43828-BLKG](#) [A82-1](#) [RF2878TR7](#) [BGA 728L7 E6327](#) [BGB719N7ESDE6327XTMA1](#) [HMC1126-SX](#) [HMC342](#) [HMC561-SX](#) [HMC598-SX](#) [HMC-ALH382-SX](#) [HMC-ALH476-SX](#) [SE2433T-R](#) [SE2622L-R](#) [SMA3101-TL-E](#) [SMA39](#) [SMA70-1](#) [A66-1](#) [A66-3](#) [A67-1](#) [LX5535LQ](#) [LX5540LL](#) [RF2373TR7](#) [HMC3653LP3BETR](#) [HMC395](#) [HMC549MS8GETR](#) [HMC576-SX](#) [HMC754S8GETR](#) [HMC-ALH435-SX](#) [SMA101](#) [SMA1031](#) [SMA181](#) [SMA32](#) [SMA411](#) [SMA531](#) [SST12LP17E-XX8E](#) [SST12LP19E-QX6E](#) [TGA2598](#) [WPM0510A](#) [HMC5929LS6TR](#) [HMC5879LS7TR](#) [HMC906A-SX](#) [HMC1127](#) [HMC544A](#) [HMC1126](#) [HMC1110-SX](#) [HMC1087F10](#) [HMC1086](#) [HMC1016](#)