

Power Amplifier 18 - 26 GHz

Rev. V1

Features

- Fully Integrated Power Amplifier
- Wide Bandwidth 17.7 - 26.5 GHz
- 28.5 dB Small Signal Gain
- 37.0 dBm Third Order Intercept Point (OIP3)
- 28.5 dBm Output P1dB
- Integrated Power Detector
- Typical Bias 5 V, 650 mA
- Lead-Free 5 mm 24-lead QFN Package

Description

The MAAP-118260 is a packaged linear power amplifier that operates over the frequency range 17.7 - 26.5 GHz. The device provides 28.5 dB of gain and 37.0 dBm Output Third Order Intercept Point (OIP3) with more than 28.5 dBm of Output P1dB.

This power amplifier is assembled in a lead free, fully molded 5 mm, 24 lead, QFN package and consists of a four stage power amplifier with integrated, on-chip power and envelope detectors. The device includes on-chip ESD protection structures to ease the implementation and volume assembly.

The device is well suited for use in the 18 GHz, 23 GHz, 26 GHz cellular backhaul applications.

Ordering Information^{1,2}

Part Number	Package
MAAP-118260	Bulk
MAAP-118260-TR0500	Tape and Reel
MAAP-118260-001SMB	Sample Board

1. Reference Application Note M513 for reel size information.
2. All sample boards include 5 loose parts.

Functional Schematic

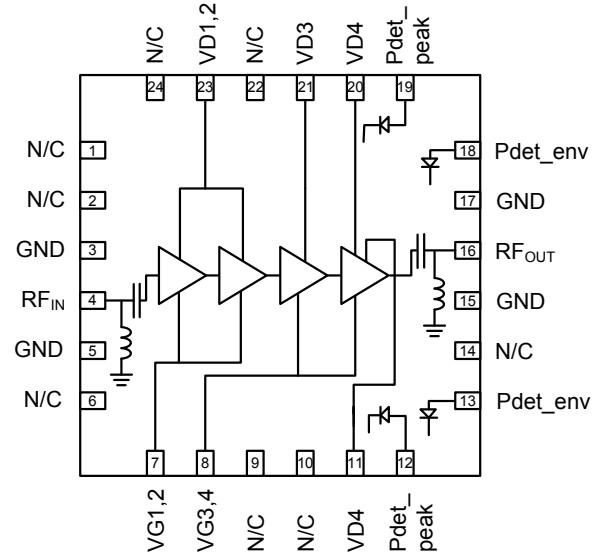

Pin Configuration^{3,4}

Pin No.	Function	Pin No.	Function
1	No Connection	13	Pdet_env
2	No Connection	14	No Connection
3	GND	15	GND
4	RF _{IN}	16	RF _{OUT}
5	GND	17	GND
6	No Connection	18	Pdet_env
7	V _G 1,2	19	Pdet_peak
8	V _G 3,4	20	V _D 4
9	No Connection	21	V _D 3
10	No Connection	22	No Connection
11	V _D 4	23	V _D 1,2
12	Pdet_peak	24	No Connection

3. MACOM recommends connecting unused package pins to ground.
4. The exposed pad centered on the package bottom must be connected to RF, DC and thermal ground.

* Restrictions on Hazardous Substances, European Union Directive 2011/65/EU.

Electrical Specifications: Freq. = 17.7 - 26.5 GHz, T_A = 25°C, V_D = +5 V, Z₀ = 50 Ω

Parameter	Test Conditions	Units	Min.	Typ.	Max.
Gain	17.7 - 20.0 GHz	dB	25	29.5	—
	20.0 - 24.0 GHz		24	28.5	
	24.0 - 26.5 GHz		23	25.5	
P1dB, @ 1 dB Compression	17.7 - 20.0 GHz	dBm	—	28.0	—
	20.0 - 24.0 GHz		—	29.0	
	24.0 - 26.5 GHz		—	28.5	
P _{SAT}	17.7 - 20.0 GHz	dBm	29	30.5	—
	20.0 - 24.0 GHz		29	31.0	
	24.0 - 26.5 GHz		29	30.5	
OIP3	17.7 - 20.0 GHz	dBm	36	37.0	—
	20.0 - 24.0 GHz		34	36.7	
	24.0 - 26.5 GHz		34	36.5	
Input Return Loss	17.7 - 20.0 GHz	dB	—	13	—
	20.0 - 24.0 GHz		—	9.5	
	24.0 - 26.5 GHz		—	14	
Output Return Loss	17.7 - 20.0 GHz	dB	—	12	—
	20.0 - 24.0 GHz		—	11	
	24.0 - 26.5 GHz		—	15	
PAE, @ 1 dB Compression	—	%	—	18	—
Quiescent Current	—	mA	590	—	662

Absolute Maximum Ratings^{5,6,7}

Parameter	Rating
Drain Voltage (V _D 1,2,3,4) (Under No RF Drive)	9 V
Drain Voltage (V _D 1,2,3,4) (Under RF Drive)	5.5 V
Gate Voltage (V _G 1,2,3,4)	-3 V
Storage Temperature	-65°C to +150°C
Junction Temperature	+175°C

5. Exceeding any one or combination of these limits may cause permanent damage to this device.
6. MACOM does not recommend sustained operation near these survivability limits.
7. Operating at nominal conditions with T_J ≤ +150°C will ensure MTTF > 1 x 10⁶ hours.

Maximum Operating Ratings^{8,9}

Parameter	Rating
P _{DISS}	4.87 W
Operating Temperature	-40°C to +85°C
Junction Temperature	+150°C

8. Junction temperature directly affects device MTTF. Junction temperature should be kept as low as possible to maximize lifetime. Thermal resistance, Θ_{JC} is 18.4 °C/W.
9. For saturated performance, it is recommended that the sum of (2V_{DD} + abs(V_{GG})) < 12 V.

MAAP-118260



Power Amplifier
18 - 26 GHz

Rev. V1

PCB Layout

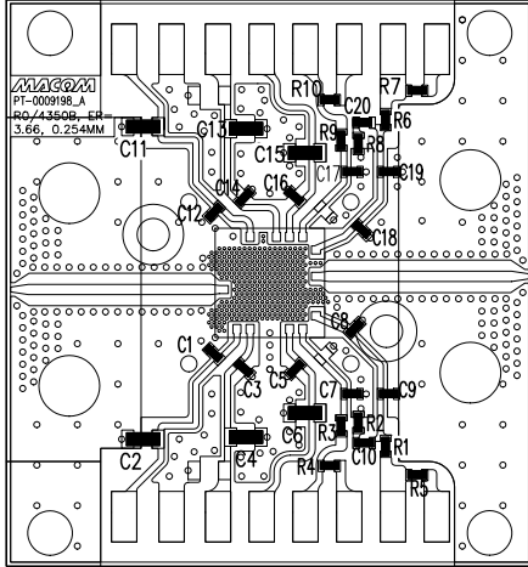

Parts List

Part	Value	Case Style
C1,C3,C5,C7, C8 - C10,C12, C14,C16 - C20	100 nF	0402
C2,C4,C6,C11, C13,C15	4.7 μ F	0603
R1,R3,R6,R9	100 Ω	0402
R2,R8	10 K Ω	0402
R4,R5,R7,R10	5600 Ω	0402

Application Schematic

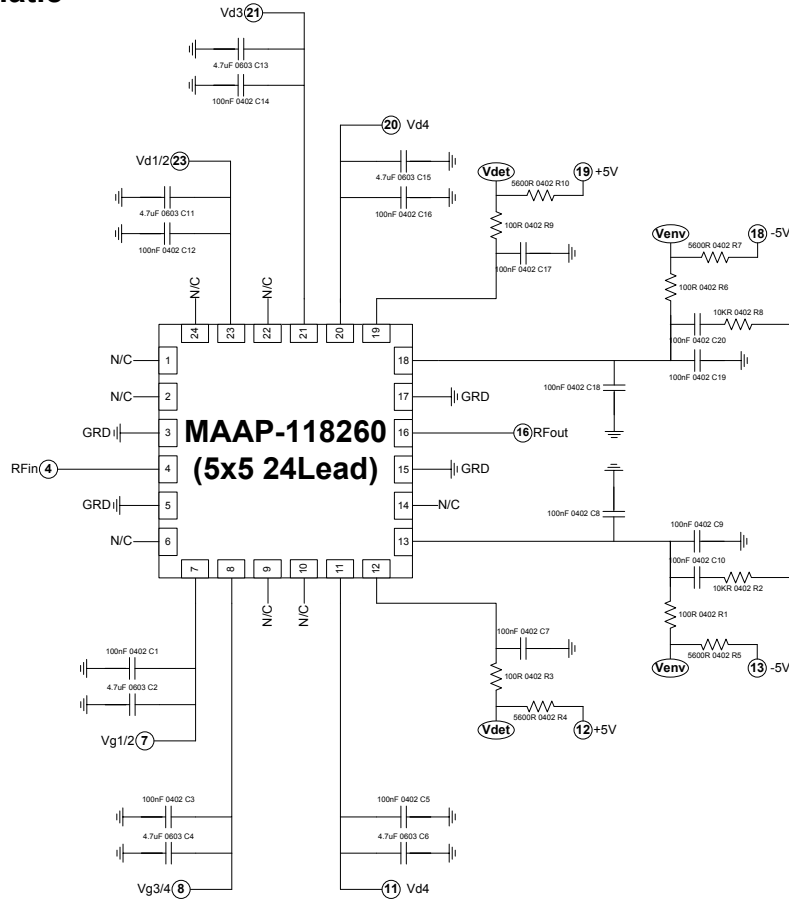

Biasing

All gates should be pinched-off, $V_G < -2$ V, before applying the drain voltage, $V_D = 5$ V (do not exceed maximum V_{DG} value for RF drive condition). Then the gate voltages can be increased until the desired quiescent drain current is reached in each stage. The recommended quiescent bias is $V_D = 5$ V, $I_{D1,2} + I_{D3} + I_{D4} = 650$ mA (total). The performance in this datasheet has been measured with a fixed gate voltage and no drain current regulation under large signal operation. It is also possible to regulate the drain current dynamically, to limit the DC power dissipation under RF drive. To turn off the device, the turn on bias sequence should be followed in reverse.

Detector Operation

MAAP-118260 includes dual power and envelope detectors. These are included on both sides of the device to ease integration onto larger radio boards. As per the application schematic, the power detector requires an external 5 V supply and the envelope detector requires -5 V. The output from the resistive voltage divider can be fed into a ADC or multimeter for the result.

Bias Arrangement

Each DC pin ($V_{D1,2}$, V_{D3} , V_{D4} and $V_{G1,2}$, $V_{G3,4}$) needs to have bypass capacitance of 100 nF mounted as close to the packaged device as possible.

Handling Procedures

Please observe the following precautions to avoid damage:

Static Sensitivity

These electronic devices are sensitive to electrostatic discharge (ESD) and can be damaged by static electricity. Proper ESD control techniques should be used when handling these CDM class C1, HBM Class 0A devices.

Power Amplifier 18 - 26 GHz

Rev. V1

Typical Performance Curves: $V_D = 5\text{ V}$, $I_{DQ} = 0.65\text{ A}$, $V_G = -1.05 \sim -0.85\text{ V}$, $T_A = +25^\circ\text{C}$

Broadband S-Parameters vs. Freq (GHz), $V_d = 5\text{V}$, $I_d = 0.65\text{A}$

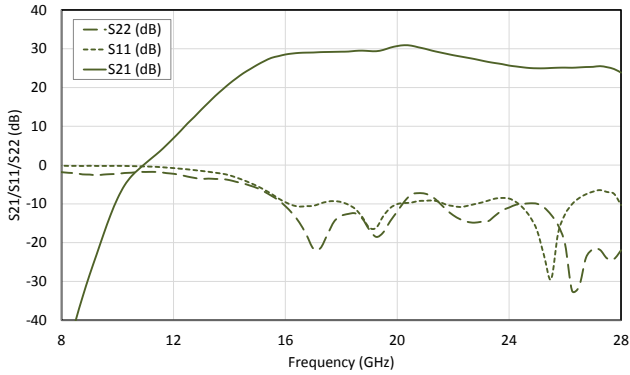

Gain (S21) vs. Freq (GHz), $V_d = 5\text{V}$, $I_d = 0.65\text{A}$

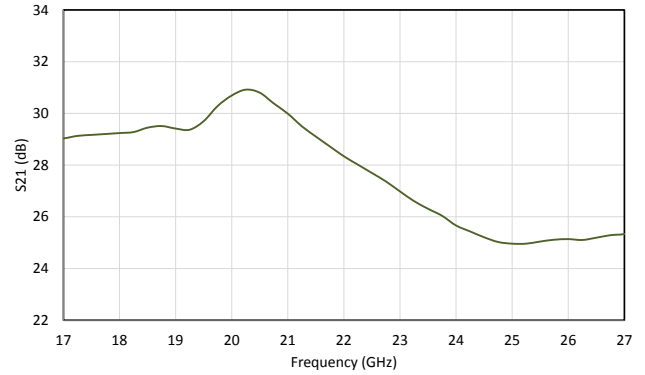

Return Loss (S11/S22) vs. Freq (GHz), $V_d = 5\text{V}$, $I_d = 0.65\text{A}$

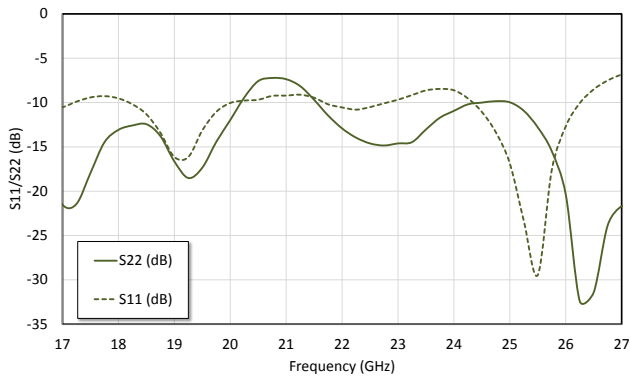

P1dB/P3dB/Psat (dBm) vs. Freq (GHz), $V_d = 5\text{V}$, $I_d = 650\text{mA}$

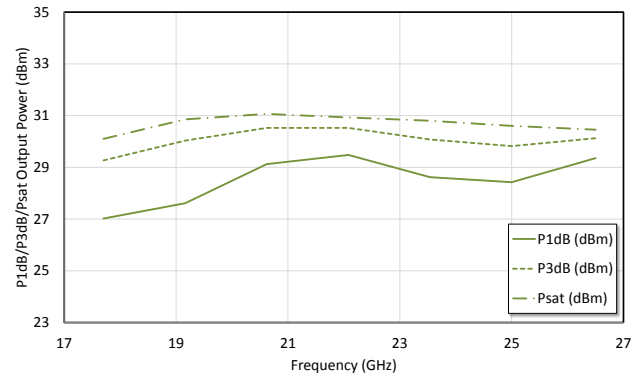

Output IP3 (dBm) vs. SCL Output Power,
 $V_d = 5\text{V}$, $I_d = 650\text{mA}$

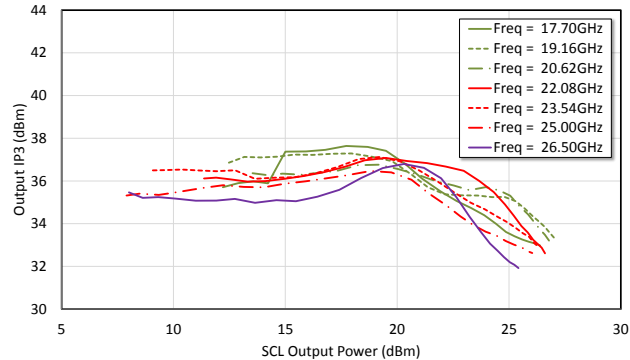

Output IP3 (dBm) vs. Freq (GHz), $V_d = 5\text{V}$, $I_d = 650\text{mA}$

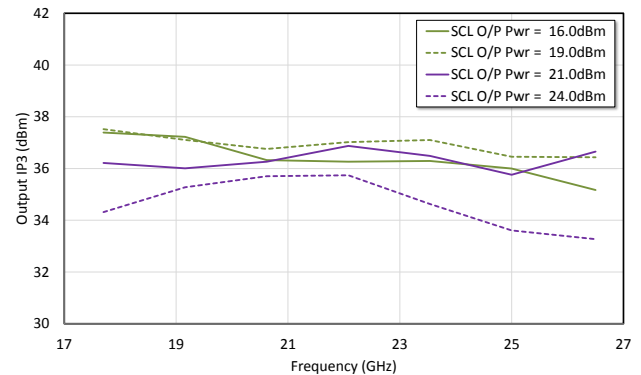

Power Amplifier 18 - 26 GHz

Rev. V1

Typical Performance Curves: $V_D = 5\text{ V}$, $I_{DQ} = 0.65\text{ A}$, $V_G = -1.05 \sim -0.85\text{ V}$, $T_A = +25^\circ\text{C}$

Output Power (dBm), Power Gain (dB), Drain Current (mA)
vs. Input Power (dBm) @ 17.70GHz, $V_d = 5\text{V}$, $I_d = 650\text{mA}$

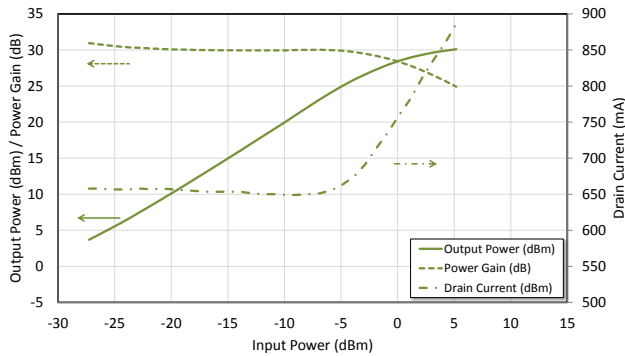

Power Gain (dB) and Power Added Efficiency (%) vs. Output Power (dBm) @ 17.70GHz, $V_d = 5\text{V}$, $I_d = 650\text{mA}$

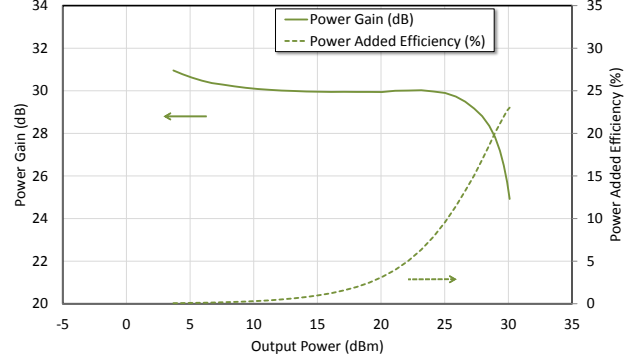

Output Power (dBm), Power Gain (dB), Drain Current (mA)
vs. Input Power (dBm) @ 19.16GHz, $V_d = 5\text{V}$, $I_d = 650\text{mA}$

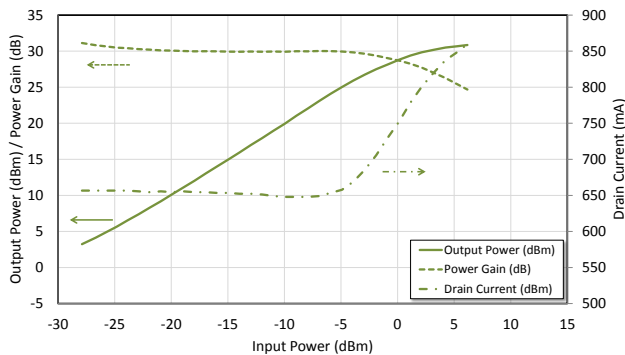

Power Gain (dB) and Power Added Efficiency (%) vs. Output Power (dBm) @ 19.16GHz, $V_d = 5\text{V}$, $I_d = 650\text{mA}$

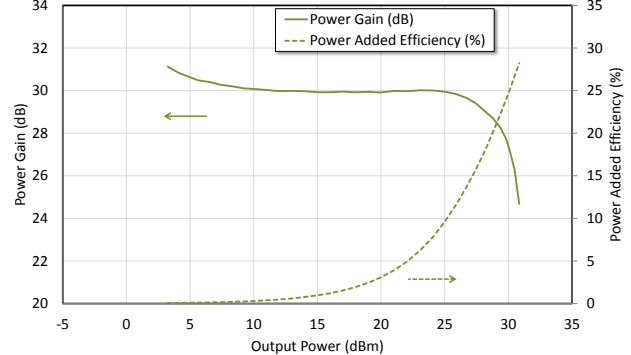

Output Power (dBm), Power Gain (dB), Drain Current (mA)
vs. Input Power (dBm) @ 20.62GHz, $V_d = 5\text{V}$, $I_d = 650\text{mA}$

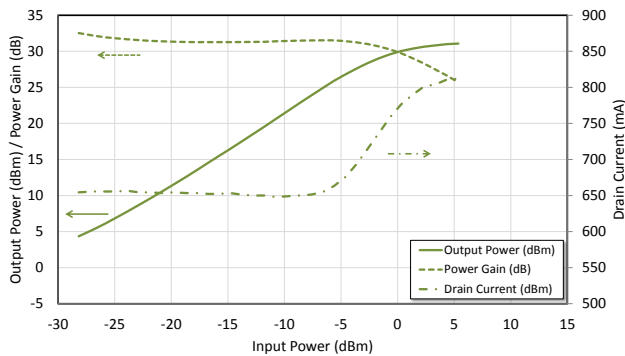

Power Gain (dB) and Power Added Efficiency (%) vs. Output Power (dBm) @ 20.62GHz, $V_d = 5\text{V}$, $I_d = 650\text{mA}$

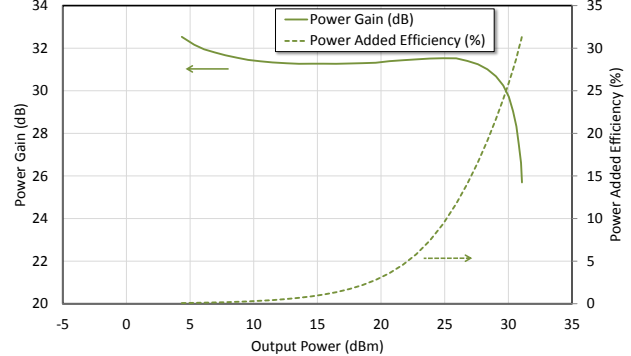

Power Amplifier 18 - 26 GHz

Rev. V1

Typical Performance Curves: $V_D = 5\text{ V}$, $I_{DQ} = 0.65\text{ A}$, $V_G = -1.05 \sim -0.85\text{ V}$, $T_A = +25^\circ\text{C}$

Output Power (dBm), Power Gain (dB), Drain Current (mA)
vs. Input Power (dBm) @ 22.08GHz, $V_d = 5\text{V}$, $I_d = 650\text{mA}$

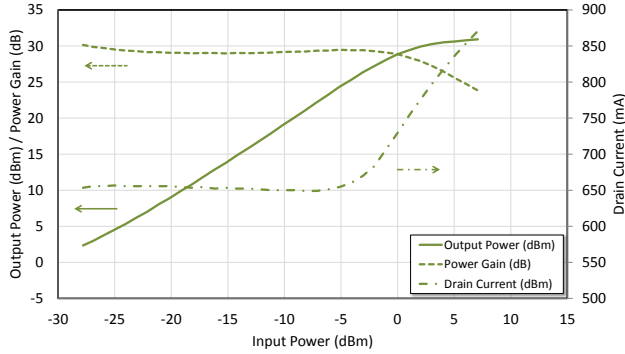

Power Gain (dB) and Power Added Efficiency (%) vs. Output Power (dBm) @ 22.08GHz, $V_d = 5\text{V}$, $I_d = 650\text{mA}$

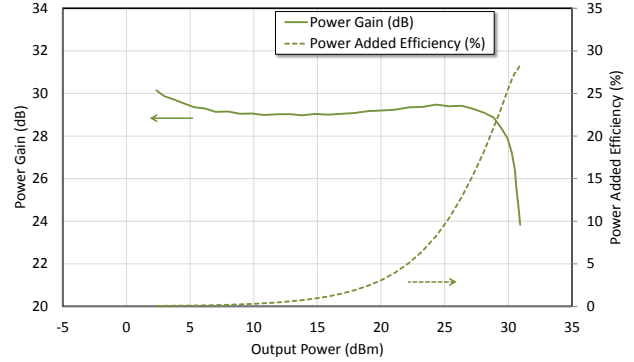

Output Power (dBm), Power Gain (dB), Drain Current (mA)
vs. Input Power (dBm) @ 23.54GHz, $V_d = 5\text{V}$, $I_d = 650\text{mA}$

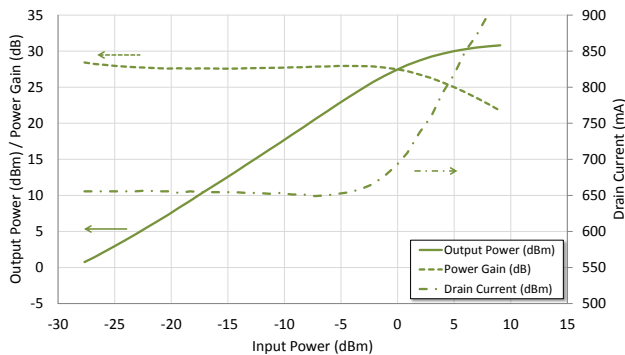

Power Gain (dB) and Power Added Efficiency (%) vs. Output Power (dBm) @ 23.54GHz, $V_d = 5\text{V}$, $I_d = 650\text{mA}$

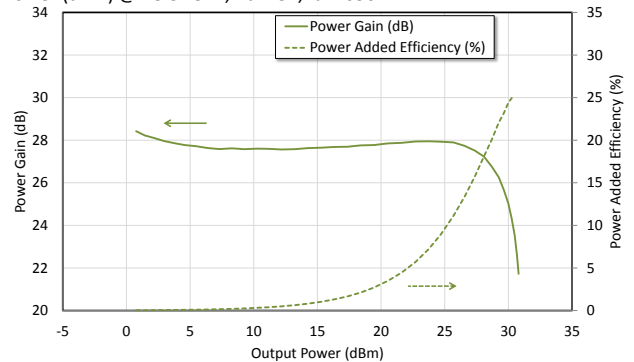

Output Power (dBm), Power Gain (dB), Drain Current (mA)
vs. Input Power (dBm) @ 25.00GHz, $V_d = 5\text{V}$, $I_d = 650\text{mA}$

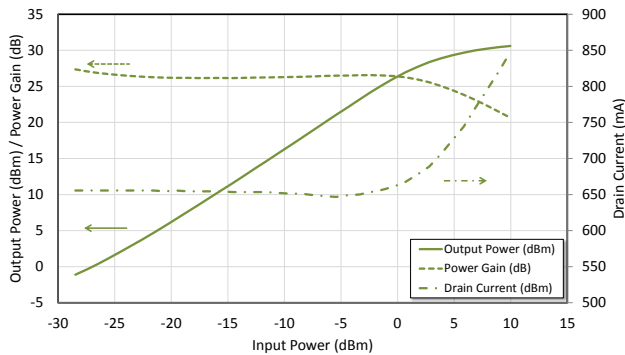

Power Gain (dB) and Power Added Efficiency (%) vs. Output Power (dBm) @ 25.00GHz, $V_d = 5\text{V}$, $I_d = 650\text{mA}$

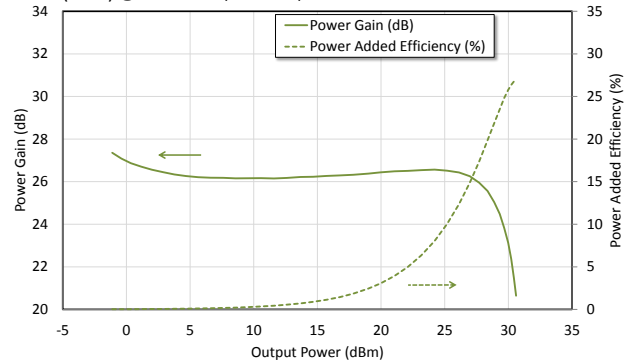

Power Amplifier 18 - 26 GHz

Rev. V1

Typical Performance Curves: $V_D = 5\text{ V}$, $I_{DQ} = 0.65\text{ A}$, $V_G = -1.05 \sim -0.85\text{ V}$, $T_A = +25^\circ\text{C}$

Output Power (dBm), Power Gain (dB), Drain Current (mA)
vs. Input Power (dBm) @ 26.50GHz, $V_d = 5\text{V}$, $I_d = 650\text{mA}$

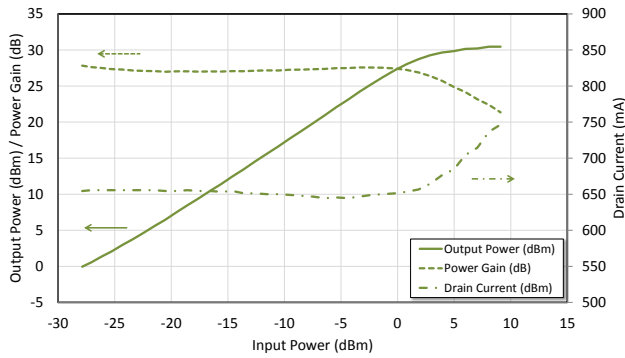

Power Gain (dB) and Power Added Efficiency (%) vs. Output Power (dBm) @ 26.50GHz, $V_d = 5\text{V}$, $I_d = 650\text{mA}$

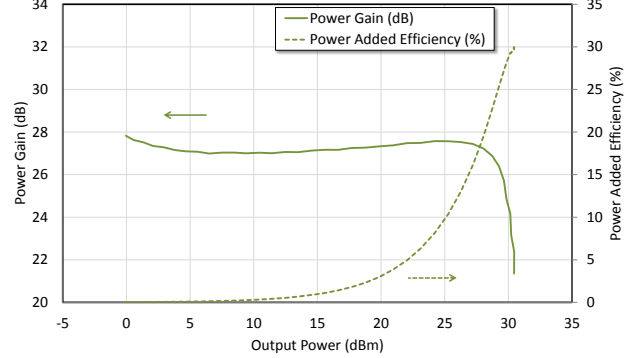

Envelope Detector Voltage (V) vs. Output Power,
 $V_d = 5\text{V}$, $I_d = 650\text{mA}$

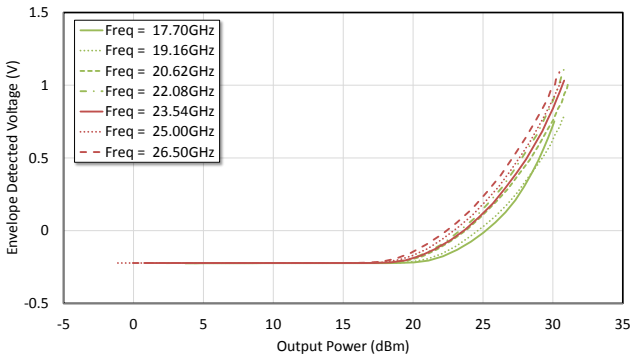

Peak Detector Voltage (V) vs. Output Power,
 $V_d = 5\text{V}$, $I_d = 650\text{mA}$

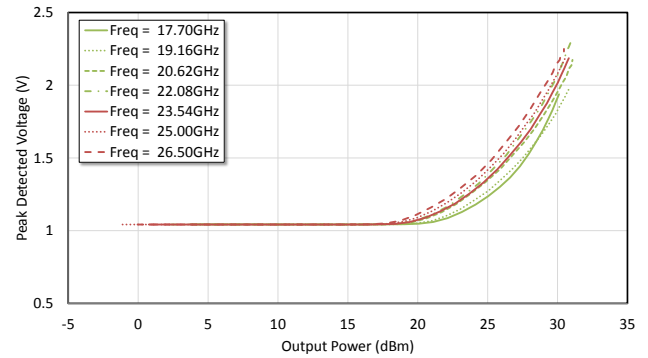

3rd Order Intermodulation (dBm) vs. SCL Output Power,
 $V_d = 5\text{V}$, $I_d = 650\text{mA}$

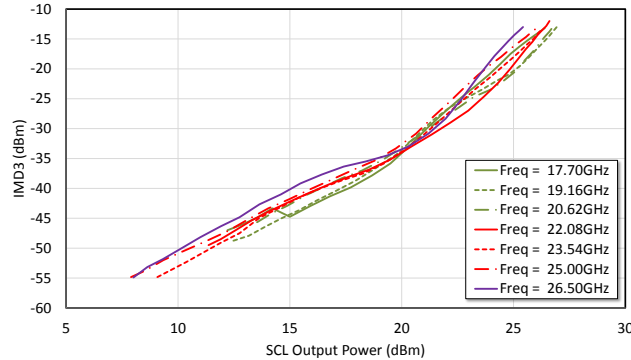

Power Amplifier 18 - 26 GHz

Rev. V1

Typical Performance Curves: $V_D = 5\text{ V}$, $I_{DQ} = 0.65\text{ A}$, $V_G = -1.05 \sim -0.85\text{ V}$, $T_A = -40^\circ\text{C} \sim +85^\circ\text{C}$

S21 (dB) vs. Freq (GHz), $V_d = 5\text{ V}$, $I_d = 0.65\text{ A}$

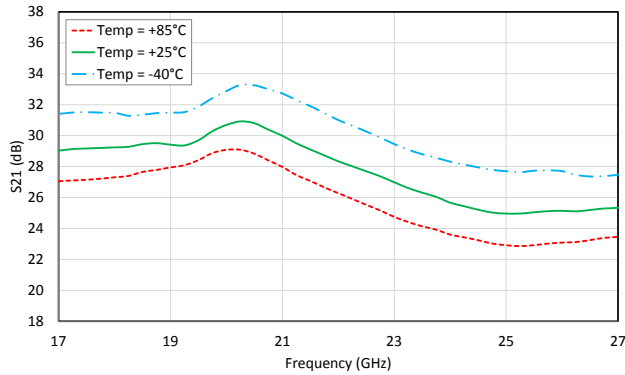

S11 (dB) vs. Freq (GHz), $V_d = 5\text{ V}$, $I_d = 0.65\text{ A}$

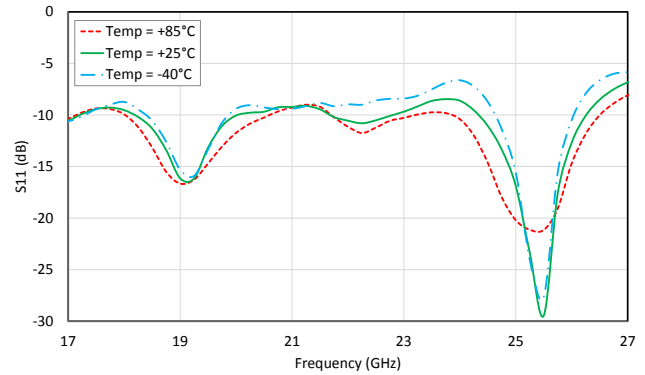

S22 (dB) vs. Freq (GHz), $V_d = 5\text{ V}$, $I_d = 0.65\text{ A}$

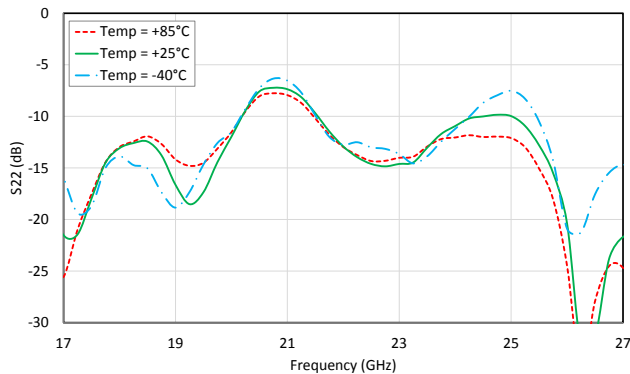

P1dB (dBm) vs. Frequency (GHz), $V_d = 5\text{ V}$, $I_d = 650\text{ mA}$

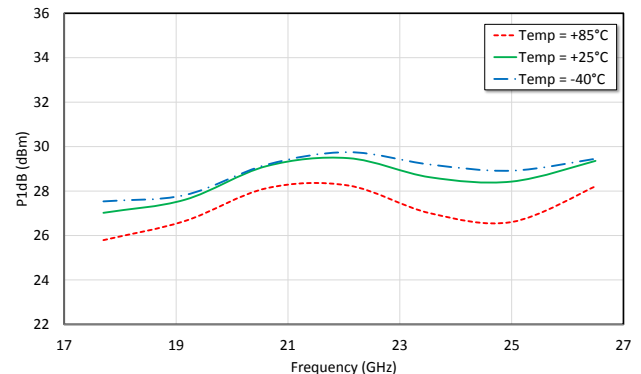

P3dB (dBm) vs. Frequency (GHz), $V_d = 5\text{ V}$, $I_d = 650\text{ mA}$

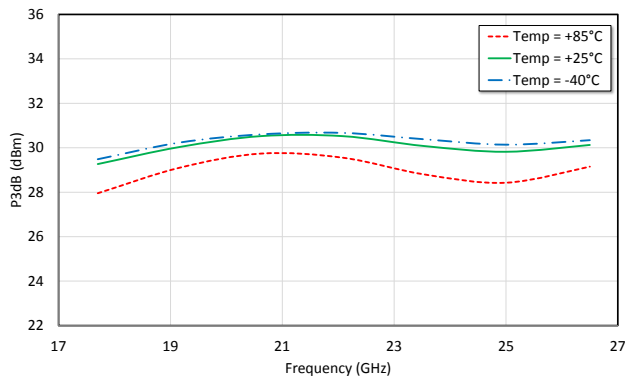

Psat (dBm) vs. Frequency (GHz), $V_d = 5\text{ V}$, $I_d = 650\text{ mA}$

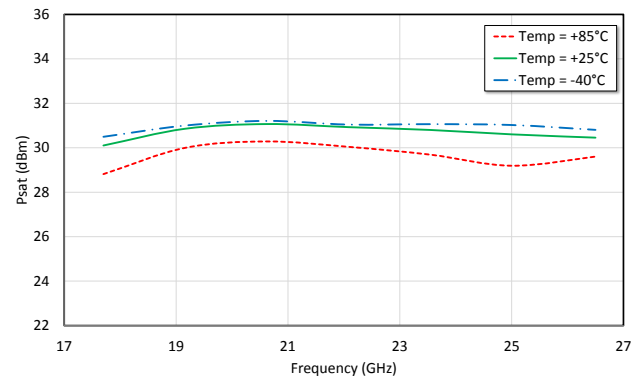

Power Amplifier 18 - 26 GHz

Rev. V1

Typical Performance Curves: $V_D = 5\text{ V}$, $I_{DQ} = 0.65\text{ A}$, $V_G = -1.05 \sim -0.85\text{ V}$, $T_A = -40^\circ\text{C} \sim +85^\circ\text{C}$

Output IP3 (dBm) @ 19dBm SCL O/P Power vs. Freq (GHz),
 $V_d = 5\text{ V}$, $I_d = 650\text{ mA}$

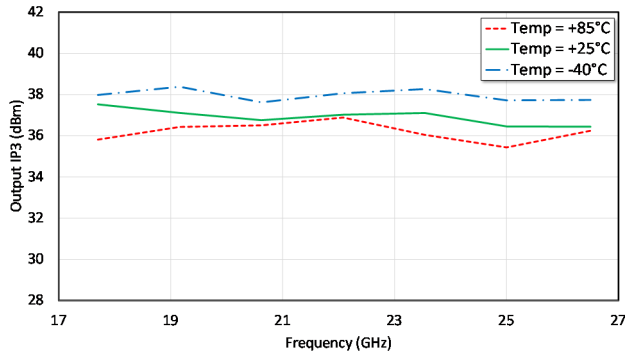

Output IP3 (dBm) @ 21dBm SCL O/P Power vs. Freq (GHz),
 $V_d = 5\text{ V}$, $I_d = 650\text{ mA}$

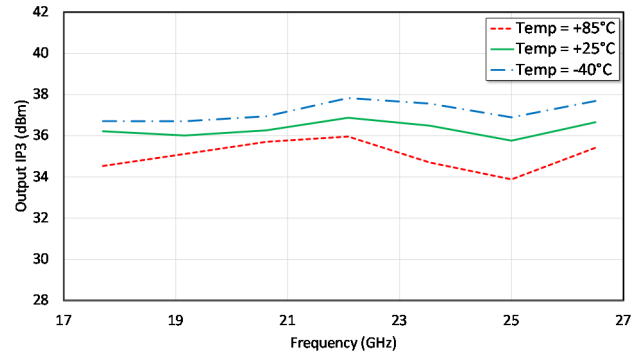

Output IP3 (dBm) @ 24dBm SCL O/P Power vs. Freq (GHz),
 $V_d = 5\text{ V}$, $I_d = 650\text{ mA}$

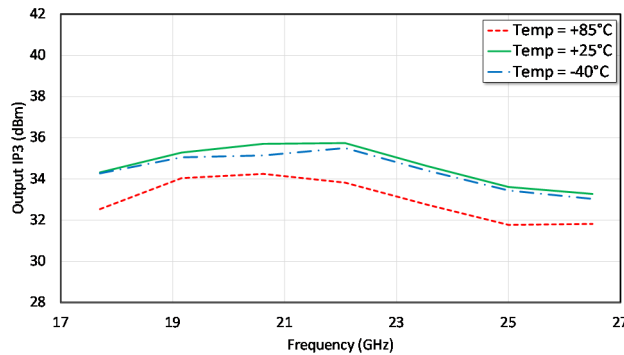

Typical Performance Curves: $V_D = 5\text{ V}$, $I_{DQ} = \text{Various}$, $V_G = -0.85 \sim -1.65\text{ V}$, $T_A = +25^\circ\text{C}$

Gain (S21) vs. Freq (GHz), Various Bias Points

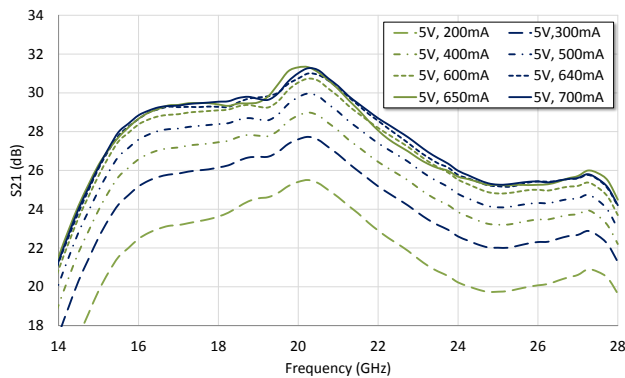

Input Return Loss (S11) vs. Freq (GHz), Various Bias Points

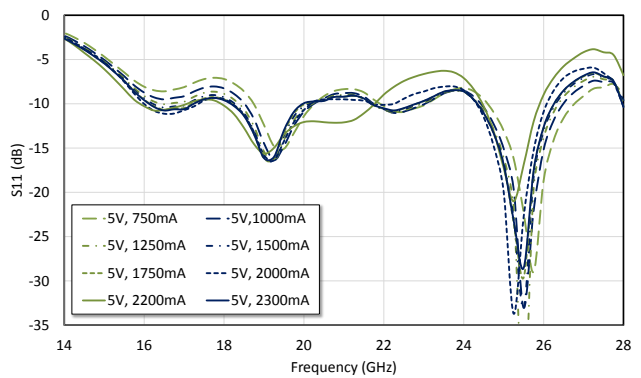

Power Amplifier 18 - 26 GHz

Rev. V1

Typical Performance Curves: $V_D = 5\text{ V}$, $I_{DQ} = \text{Various}$, $V_G = -0.85 \sim -1.65\text{ V}$, $T_A = +25^\circ\text{C}$

Output Return Loss (S22) vs. Freq (GHz), Various Bias Points

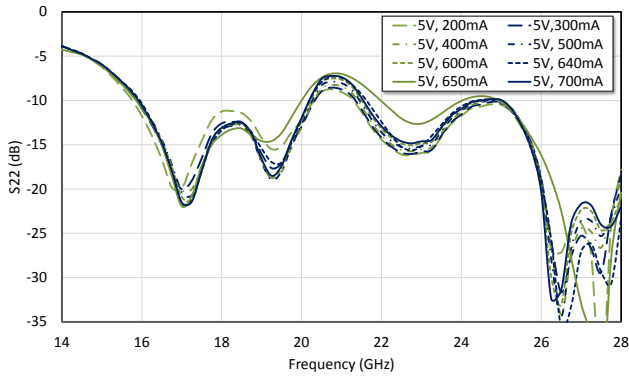

Output IP3 (dBm) vs. Drain Current (mA),

$V_d = 5\text{ V}$, $I_d = \text{Various}$

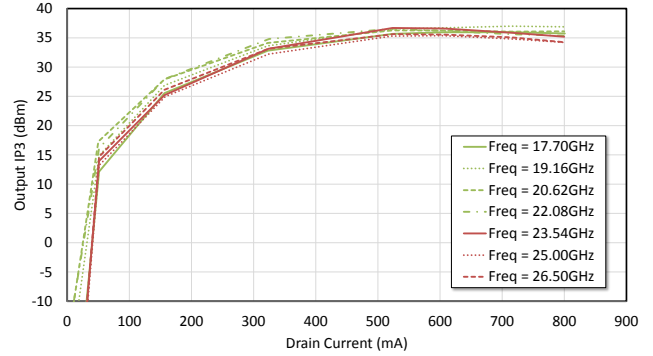

Gain (dB) vs. Drain Current (mA),

$V_d = 5\text{ V}$, $I_d = \text{Various}$

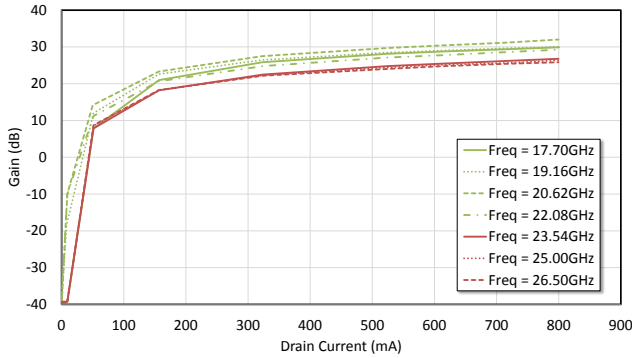

Output IP3 (dBm) vs. Gain (dB),

$V_d = 5\text{ V}$, $I_d = \text{Various}$

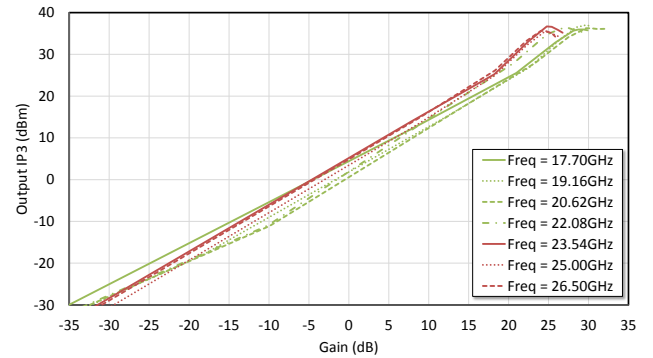

Lead-Free 5 mm 24-Lead PQFN[†]

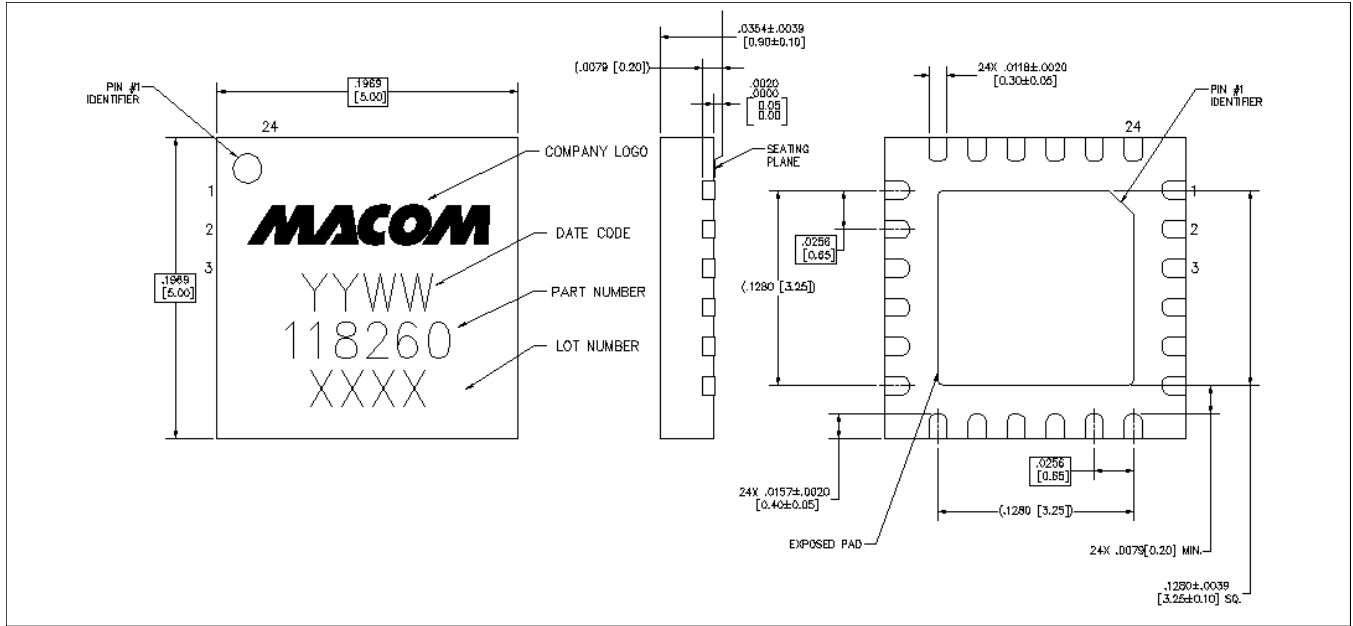

[†] Reference Application Note S2083 for lead-free solder reflow recommendations.
Meets JEDEC moisture sensitivity level 3 requirements.
Plating is NiPdAu

MACOM Technology Solutions Inc. All rights reserved.

Information in this document is provided in connection with MACOM Technology Solutions Inc ("MACOM") products. These materials are provided by MACOM as a service to its customers and may be used for informational purposes only. Except as provided in MACOM's Terms and Conditions of Sale for such products or in any separate agreement related to this document, MACOM assumes no liability whatsoever. MACOM assumes no responsibility for errors or omissions in these materials. MACOM may make changes to specifications and product descriptions at any time, without notice. MACOM makes no commitment to update the information and shall have no responsibility whatsoever for conflicts or incompatibilities arising from future changes to its specifications and product descriptions. No license, express or implied, by estoppel or otherwise, to any intellectual property rights is granted by this document.

THESE MATERIALS ARE PROVIDED "AS IS" WITHOUT WARRANTY OF ANY KIND, EITHER EXPRESS OR IMPLIED, RELATING TO SALE AND/OR USE OF MACOM PRODUCTS INCLUDING LIABILITY OR WARRANTIES RELATING TO FITNESS FOR A PARTICULAR PURPOSE, CONSEQUENTIAL OR INCIDENTAL DAMAGES, MERCHANTABILITY, OR INFRINGEMENT OF ANY PATENT, COPYRIGHT OR OTHER INTELLECTUAL PROPERTY RIGHT. MACOM FURTHER DOES NOT WARRANT THE ACCURACY OR COMPLETENESS OF THE INFORMATION, TEXT, GRAPHICS OR OTHER ITEMS CONTAINED WITHIN THESE MATERIALS. MACOM SHALL NOT BE LIABLE FOR ANY SPECIAL, INDIRECT, INCIDENTAL, OR CONSEQUENTIAL DAMAGES, INCLUDING WITHOUT LIMITATION, LOST REVENUES OR LOST PROFITS, WHICH MAY RESULT FROM THE USE OF THESE MATERIALS.

MACOM products are not intended for use in medical, lifesaving or life sustaining applications. MACOM customers using or selling MACOM products for use in such applications do so at their own risk and agree to fully indemnify MACOM for any damages resulting from such improper use or sale.

X-ON Electronics

Largest Supplier of Electrical and Electronic Components

Click to view similar products for [RF Amplifier](#) category:

Click to view products by [MACOM](#) manufacturer:

Other Similar products are found below :

[A82-1](#) [BGA622H6820XTSA1](#) [BGA 728L7 E6327](#) [BGB719N7ESDE6327XTMA1](#) [HMC397-SX](#) [HMC405](#) [HMC561-SX](#) [HMC8120-SX](#)
[HMC8121-SX](#) [HMC-ALH382-SX](#) [HMC-ALH476-SX](#) [SE2433T-R](#) [SMA3101-TL-E](#) [SMA39](#) [A66-1](#) [A66-3](#) [A67-1](#) [LX5535LQ](#) [LX5540LL](#)
[MAAM02350](#) [HMC3653LP3BETR](#) [HMC549MS8GETR](#) [HMC-ALH435-SX](#) [SMA101](#) [SMA32](#) [SMA411](#) [SMA531](#) [SST12LP17E-XX8E](#)
[SST12LP19E-QX6E](#) [WPM0510A](#) [HMC5929LS6TR](#) [HMC5879LS7TR](#) [HMC1126](#) [HMC1087F10](#) [HMC1086](#) [HMC1016](#) [SMA1212](#)
[MAX2689EWS+T](#) [MAAMSS0041TR](#) [MAAM37000-A1G](#) [LTC6430AIUF-15#PBF](#) [CHA5115-QDG](#) [SMA70-2](#) [SMA4011](#) [A231](#) [HMC-](#)
[AUH232](#) [LX5511LQ](#) [LX5511LQ-TR](#) [HMC7441-SX](#) [HMC-ALH310](#)