

2:1 Flux Coupled Balun Transformer 5 - 100 MHz

Rev. V2

Features

- 2:1 Impedance
- Surface Mount Package
- 75 Ω Single Ended to 37.5 Ω Balance
- RoHS Compliant, Lead Free
- Available on Tape and Reel

Description

The MABA-009776-CF28A0 is a 2:1 RF flux coupled step-down balun transformer with out a center tap, in a surface mount package.

Ideally suited for high volume CATV/Broadband applications.

Schematic

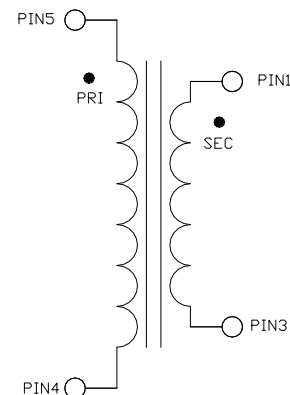

Pin Configuration

Pin #	Function
1	Secondary Dot
2	No Connection
3	Secondary
4	Primary
5	Primary Dot

Electrical Specifications: Freq. = 5 - 100 MHz, $T_A = 25^\circ\text{C}$, $Z_0 = 75 \Omega$, $P_{IN} = 0 \text{ dBm}$

Parameter	Test Conditions	Units	Min.	Typ.	Max.
Insertion Loss 1 (Pin 5 to Pin 1)	5 - 100 MHz	dB	—	0.4	0.8
Insertion Loss 2 (Pin 5 to Pin 3)	5 - 100 MHz	dB	—	0.4	0.8
Amplitude Balance	5 - 100 MHz	dB	—	0.1	± 1.0
Phase Balance	5 - 100 MHz	$^\circ$	—	2.0	± 6.0
Input Return Loss (Pin 4)	5 - 100 MHz	dB	14	22	—

Ordering Information

Part #	Package
MABA-009776-CF28A0	2000
MABA-009776-CF28TB	Customer Test Board

Recommended Maximum Ratings

Parameter	Value
RF Power	27 dBm (500 mW)
DC Current	300 mA
Operating Temperature	-40°C to $+100^\circ\text{C}$
Storage Temperature	-55°C to $+115^\circ\text{C}$

Typical Performance: $T_A = 25^\circ\text{C}$, $Z_0 = 75 \Omega$, $P_{IN} = 0 \text{ dBm}$

Insertion Loss 1 (Pin5 - Pin1)

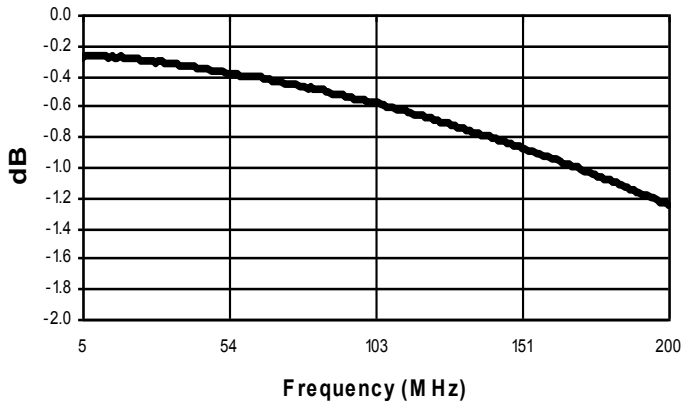

Insertion Loss 2 (Pin5 - Pin3)

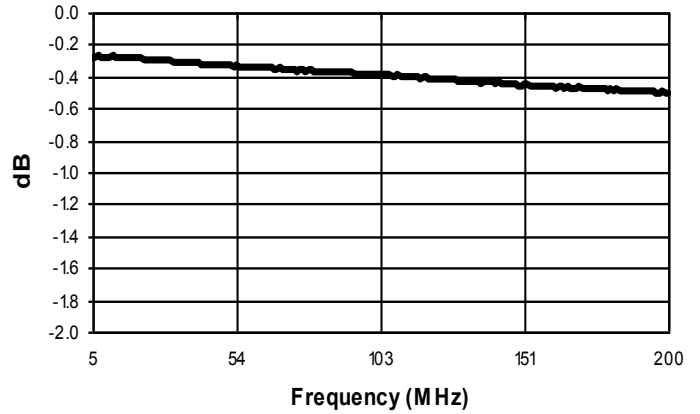

Amplitude Balance

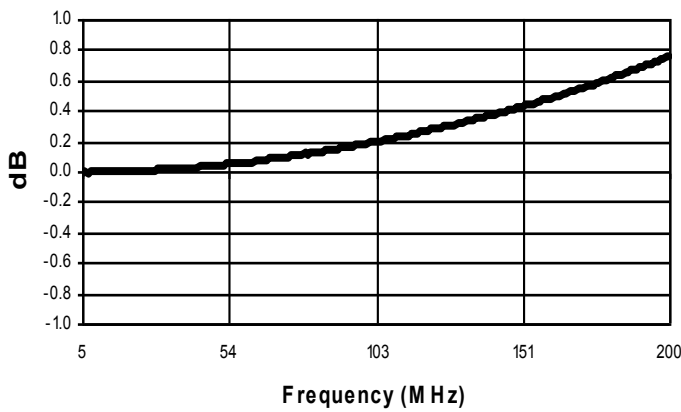

Phase Balance

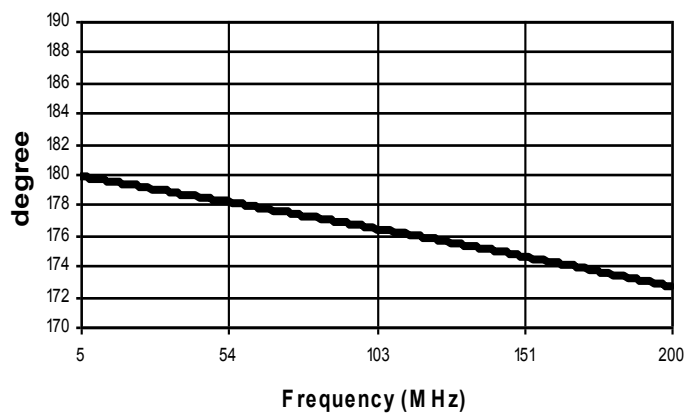

Return Loss: Input (Pin5)

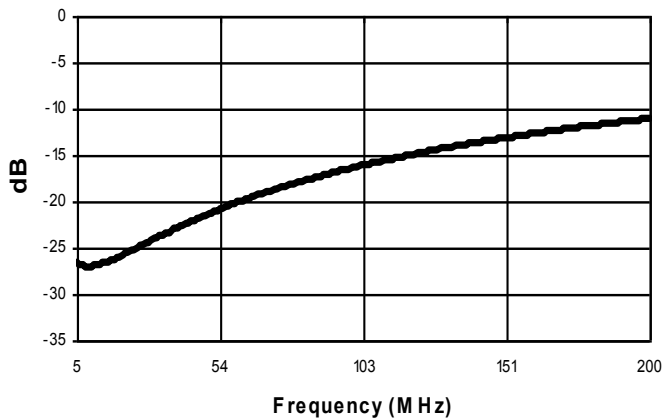

Note:

Graphs plotted to 200 MHz for reference only.

Application Circuit

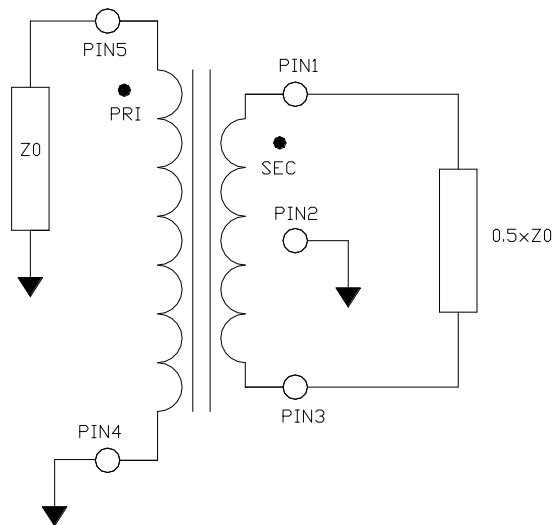

Case Style SM-164

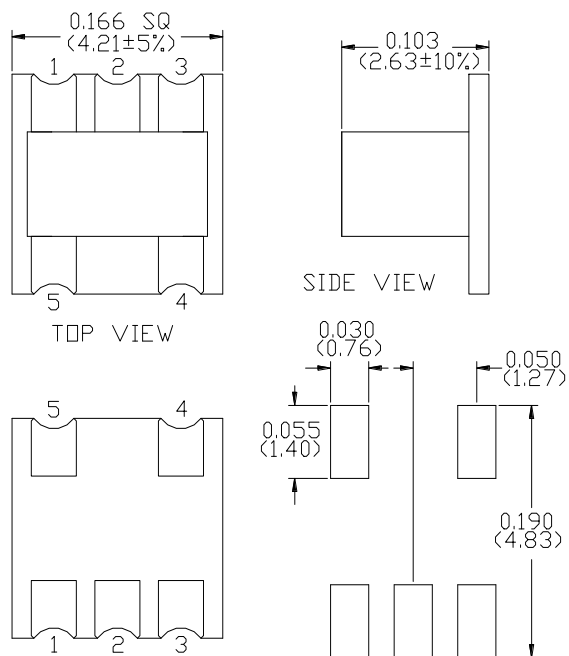

Dimensions are inches (millimetres) ± 0.015 (0.38) unless otherwise specified.

MACOM Technology Solutions Inc. All rights reserved.

Information in this document is provided in connection with MACOM Technology Solutions Inc ("MACOM") products. These materials are provided by MACOM as a service to its customers and may be used for informational purposes only. Except as provided in MACOM's Terms and Conditions of Sale for such products or in any separate agreement related to this document, MACOM assumes no liability whatsoever. MACOM assumes no responsibility for errors or omissions in these materials. MACOM may make changes to specifications and product descriptions at any time, without notice. MACOM makes no commitment to update the information and shall have no responsibility whatsoever for conflicts or incompatibilities arising from future changes to its specifications and product descriptions. No license, express or implied, by estoppel or otherwise, to any intellectual property rights is granted by this document.

THESE MATERIALS ARE PROVIDED "AS IS" WITHOUT WARRANTY OF ANY KIND, EITHER EXPRESS OR IMPLIED, RELATING TO SALE AND/OR USE OF MACOM PRODUCTS INCLUDING LIABILITY OR WARRANTIES RELATING TO FITNESS FOR A PARTICULAR PURPOSE, CONSEQUENTIAL OR INCIDENTAL DAMAGES, MERCHANTABILITY, OR INFRINGEMENT OF ANY PATENT, COPYRIGHT OR OTHER INTELLECTUAL PROPERTY RIGHT. MACOM FURTHER DOES NOT WARRANT THE ACCURACY OR COMPLETENESS OF THE INFORMATION, TEXT, GRAPHICS OR OTHER ITEMS CONTAINED WITHIN THESE MATERIALS. MACOM SHALL NOT BE LIABLE FOR ANY SPECIAL, INDIRECT, INCIDENTAL, OR CONSEQUENTIAL DAMAGES, INCLUDING WITHOUT LIMITATION, LOST REVENUES OR LOST PROFITS, WHICH MAY RESULT FROM THE USE OF THESE MATERIALS.

MACOM products are not intended for use in medical, lifesaving or life sustaining applications. MACOM customers using or selling MACOM products for use in such applications do so at their own risk and agree to fully indemnify MACOM for any damages resulting from such improper use or sale.

X-ON Electronics

Largest Supplier of Electrical and Electronic Components

Click to view similar products for [Audio Transformers](#) / [Signal Transformers](#) category:

Click to view products by [MACOM](#) manufacturer:

Other Similar products are found below :

[CX2041NLT](#) [MGPWT-00449-P](#) [PE-64961](#) [H1302FNLT](#) [H5008FNL](#) [H5012FNL](#) [H5020FNLT](#) [H5077NLT](#) [H5084FNLT](#)
[B78476A9558A003](#) [1812WBT2-4](#) [1879479-1](#) [HX2260FNL](#) [HX5014FNL](#) [EX2024FNL](#) [FL1066](#) [T1137NLT](#) [T3012NL](#) [PE-65812FNL](#) [PE-65848FNLT](#) [H1174FNL](#) [H1302FNL](#) [H5015FNL](#) [H5019EFNL](#) [H5062FNLT](#) [CX2047LNL](#) [MGPWT-00059-P](#) [MGPWT-00266-P](#) [MGPWT-00278-P](#) [MGPWT-00431-P](#) [TTC-100](#) [TTC-143-H](#) [TTC-5032-1](#) [BX1194WNLT](#) [HX1234NLT](#) [HX5008FNLT](#) [HX5019FNL](#) [HX5084NL](#) [3-1879385-5](#) [TX1263NLT](#) [4-1879391-0](#) [T1142NL](#) [HX6101FNL](#) [HX5084FNL](#) [HX1148NL](#) [HX5020FNLT](#) [HX5014FNLT](#) [T1124NL](#)
[1879732-1](#) [2-1879391-5](#)