

Features

- Surface Mount
- 1:1 Impedance
- Excellent amplitude and phase balance
- 260°C Reflow Compatible
- RoHS* Compliant
- Available on Tape and Reel.

Description

M/A-COM's MABACT0069 is a 1:1 RF transmission line transformer with tap in a low cost, surface mount package. Ideally suited for high volume CATV applications.



Schematic

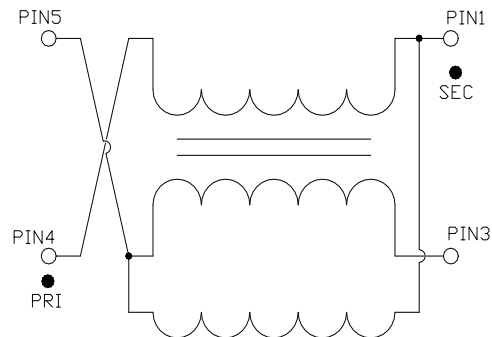

Case Style: SM-158

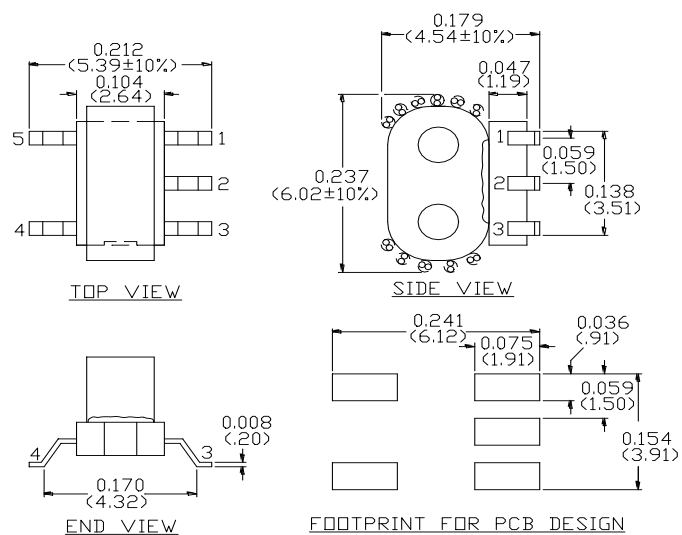

Pin Configuration

Pin No.	Function
1	Output 1: Through (Secondary dot)
2	Ground, not used
3	Output 2: Coupled (Secondary)
4	Input (Primary dot)
5	Ground (Primary)

Ordering Information

Part Number	Description
MABACT0069	1500 piece reel
MABA-008509-CT69TB	Customer test board

¹ * Restrictions on Hazardous Substances, European Union Directive 2002/95/EC.

Electrical Specifications: $T_A = 25^\circ\text{C}$, $Z_0 = 75\Omega$, $P_{in} = 0\text{dBm}$

Parameter	Test Conditions	Units	Min	Typ	Max
Insertion Loss 1: Pin 4-1 (Through)	50 - 600 MHz	dB	-	0.4	0.8
	600-1000 MHz	dB	-	0.8	1.1
	1000-1200 MHz	dB	-	1.2	1.5
Insertion Loss 2: Pin 4-3 (Coupled)	50 - 600 MHz	dB	-	0.5	0.7
	600-1200 MHz	dB	-	0.5	1.0
Amplitude Unbalance (Nominal 0dB)	50 - 600 MHz	dB	-	± 0.1	± 0.3
	600-1200 MHz	dB	-	± 0.4	± 0.9
Phase Unbalance (Nominal 180°)	50 - 870 MHz	°	-	± 1.0	± 3.0
	870-1000 MHz	°	-	± 1.5	± 5.0
	1000-1200 MHz	°	-	± 4.5	± 10.0
Input Return Loss	5 - 1200 MHz	dB	12	16	-

Recommended Maximum Ratings

Parameter	Value
Max Input Power	250mW
DC current	30mA
Operating Temperature	-40°C to +85°C
Storage Temperature	-55°C to +100°C

Application Circuit

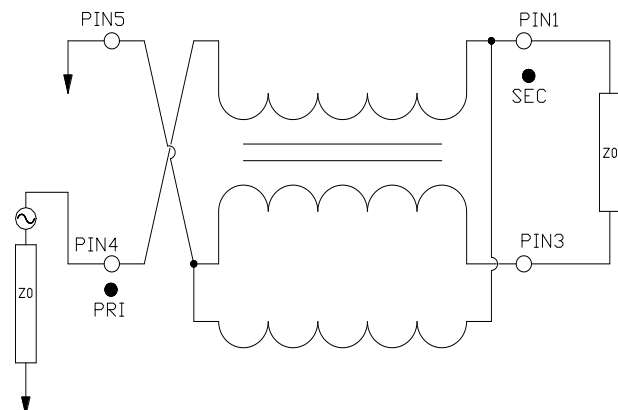

Typical Performance Curves: $T_A = 25^\circ\text{C}$, $Z_0 = 75\Omega$, $P_{in} = 0\text{dBm}$

Insertion Loss 1 (Through pin 4 to pin 1)

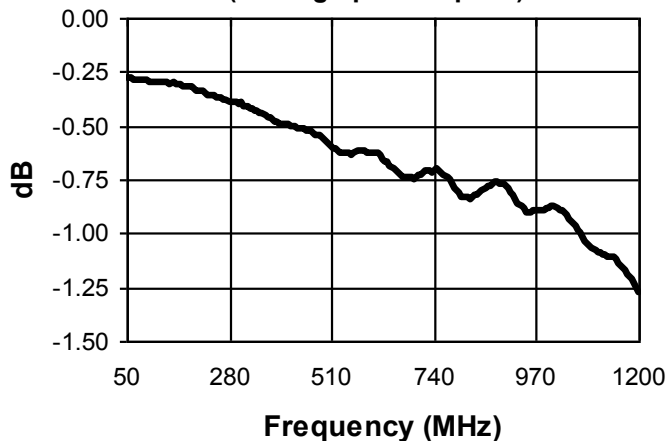

Insertion Loss 2 (Coupled pin 4 to pin 3)

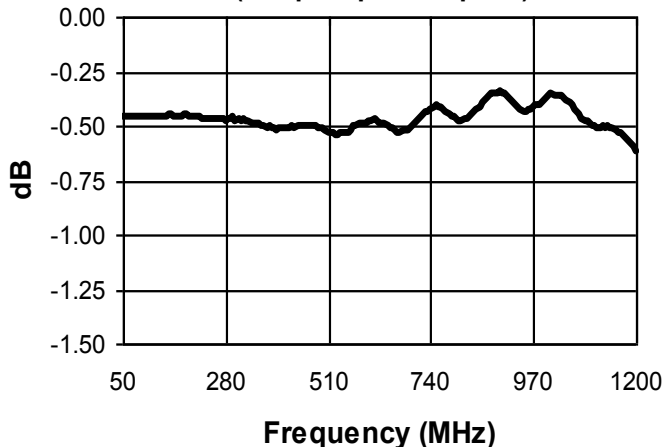

Amplitude Unbalance

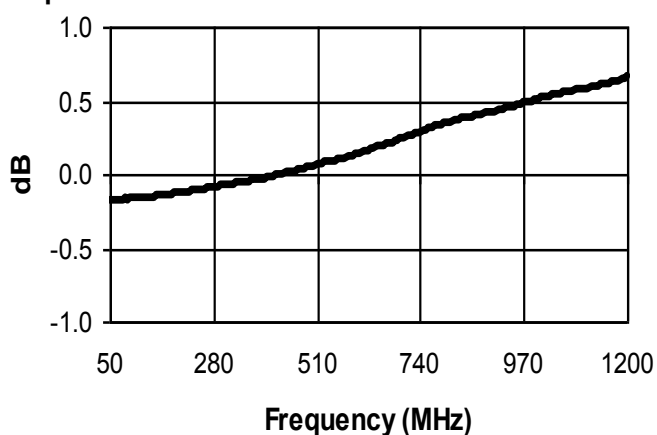

Phase Balance

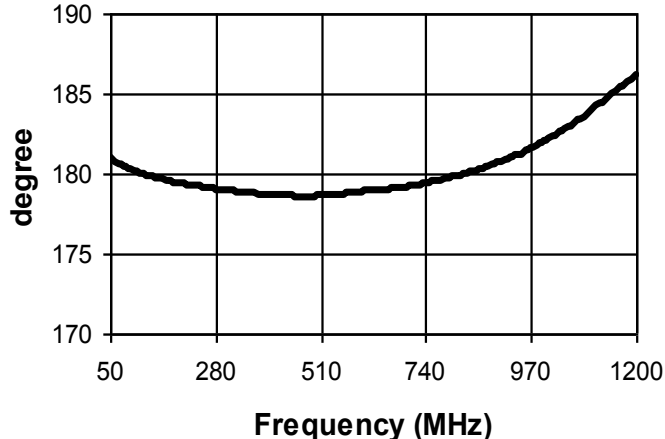

Input Return Loss

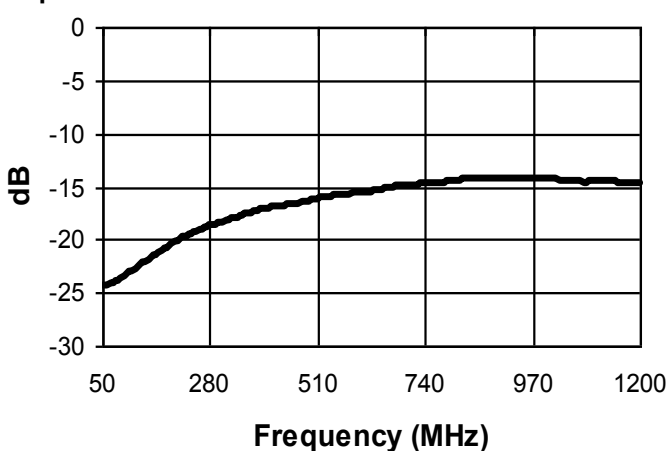

M/A-COM Technology Solutions Inc. All rights reserved.

Information in this document is provided in connection with M/A-COM Technology Solutions Inc ("MACOM") products. These materials are provided by MACOM as a service to its customers and may be used for informational purposes only. Except as provided in MACOM's Terms and Conditions of Sale for such products or in any separate agreement related to this document, MACOM assumes no liability whatsoever. MACOM assumes no responsibility for errors or omissions in these materials. MACOM may make changes to specifications and product descriptions at any time, without notice. MACOM makes no commitment to update the information and shall have no responsibility whatsoever for conflicts or incompatibilities arising from future changes to its specifications and product descriptions. No license, express or implied, by estoppel or otherwise, to any intellectual property rights is granted by this document.

THESE MATERIALS ARE PROVIDED "AS IS" WITHOUT WARRANTY OF ANY KIND, EITHER EXPRESS OR IMPLIED, RELATING TO SALE AND/OR USE OF MACOM PRODUCTS INCLUDING LIABILITY OR WARRANTIES RELATING TO FITNESS FOR A PARTICULAR PURPOSE, CONSEQUENTIAL OR INCIDENTAL DAMAGES, MERCHANTABILITY, OR INFRINGEMENT OF ANY PATENT, COPYRIGHT OR OTHER INTELLECTUAL PROPERTY RIGHT. MACOM FURTHER DOES NOT WARRANT THE ACCURACY OR COMPLETENESS OF THE INFORMATION, TEXT, GRAPHICS OR OTHER ITEMS CONTAINED WITHIN THESE MATERIALS. MACOM SHALL NOT BE LIABLE FOR ANY SPECIAL, INDIRECT, INCIDENTAL, OR CONSEQUENTIAL DAMAGES, INCLUDING WITHOUT LIMITATION, LOST REVENUES OR LOST PROFITS, WHICH MAY RESULT FROM THE USE OF THESE MATERIALS.

MACOM products are not intended for use in medical, lifesaving or life sustaining applications. MACOM customers using or selling MACOM products for use in such applications do so at their own risk and agree to fully indemnify MACOM for any damages resulting from such improper use or sale.

X-ON Electronics

Largest Supplier of Electrical and Electronic Components

Click to view similar products for [RF Adapters - Between Series](#) category:

Click to view products by [MACOM](#) manufacturer:

Other Similar products are found below :

[R191203007](#) [R191209000](#) [R191212000](#) [R191215000](#) [R191301000](#) [R191325000](#) [R191389200](#) [R191403000](#) [R191405000](#) [R191416000](#)
[R191419000](#) [R191421000](#) [R191424000](#) [R191445000](#) [R191511000](#) [R191552000](#) [R191720000](#) [R191722000](#) [R191733000](#) [R191759000](#)
[R191841001W](#) [R191911000](#) [R191912000](#) [R191968001W](#) [R192417010](#) [R921390000](#) [ADBJ20-E1-BJ379](#) [ADM2](#) [ADPL75-A1-PL75](#)
[ADPL75-E1-UBJ20](#) [9317505](#) [931RPBUFLP](#) [AD130](#) [ADBJ20-E1-PL74](#) [ADBJ20-E2-BJ79](#) [ADBJ77-A1PL3155](#) [ADBJ77-E1-UPL20](#)
[ADBJ77-E2-PL20](#) [242215](#) [242228](#) [CP-AD851](#) [R125680000W](#) [R191117000](#) [R191123000](#) [R191.147.000](#) [R191303000](#) [R191313000](#)
[R191315000](#) [R191316700](#) [R191327000](#)