

## RF 1:1 Flux Coupled Transformer 0.3 - 200 MHz

Rev. V9

### Features

- Surface Mount
- 1:1 impedance
- Available on Tape and Reel
- RoHS Compliant and Lead free
- 260°C Reflow Compatible

### Description

MABAES0060 is a RoHS compliant device that is equivalent to the ETC1-1T transformer. This device is a 1:1 RF flux coupled transformer in a SM-22 surface mount package and is designed to be utilized in both standard reflow and high temperature soldering

Ideally suited for high volume cellular and wireless applications. Typical applications include single to balanced mode conversion and impedance matching.

### Functional Schematic

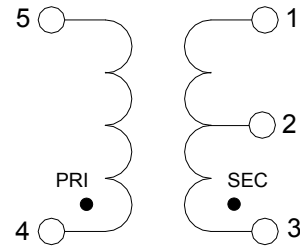

### Pin Configuration<sup>2</sup>

Pin #	Function	Pin #	Function
1	Secondary	4	Primary dot
2	Secondary CT	5	Primary
3	Secondary Dot		

2. MACOM recommends connecting unused package pins to ground.

### Electrical Specifications: Freq. = 0.3 - 200 MHz, T<sub>A</sub> = 25°C, P<sub>in</sub> = 0 dBm

Parameter	Test Conditions & Frequency (MHz)	Units	Min.	Typ.	Max.
<b>Z<sub>0</sub> = 50 Ω</b>					
Insertion Loss	0.3 - 200	dB	—	—	1.5
Amplitude Balance	0.3 - 50	dB	—	—	0.1
	0.3 - 200				0.5
Phase Balance	0.3 - 50	Degree	—	—	1.0
	0.3 - 200				5.0
Input Return Loss	0.3 - 200 5 - 120	dB	—	—	10.0 15.0
<b>Z<sub>0</sub> = 75 Ω</b>					
Insertion Loss	0.3 - 5	dB	—	—	1.7
	5 - 200				0.9
Amplitude Balance	0.3 - 50	dB	—	—	0.1
	0.3 - 200				0.5
Phase Balance	0.3 - 50	Degree	—	—	2.0
	0.3 - 200				5.0
Input Return Loss	0.3 - 5	dB	7	—	—
	5 - 120		19		
	120 - 200		15		

### Ordering Information<sup>1</sup>

Part Number	Package
MABAES0060	2000 piece reel

1. Reference Application Note M513 for reel size information.

1

MACOM Technology Solutions Inc. (MACOM) and its affiliates reserve the right to make changes to the product(s) or information contained herein without notice. Visit [www.macom.com](http://www.macom.com) for additional data sheets and product information.

For further information and support please visit:  
<https://www.macom.com/support>

## Absolute Maximum Ratings<sup>1,2</sup>

Parameter	Units
DC Power	500 mW
DC Current	500 mA
Operating Temperature	-40°C to +85°C

1. Exceeding any one or combination of these limits may cause permanent damage to this device.
2. The maximum DC current applies to the secondary center tap in applications where the secondary is balanced.

## Application Schematic

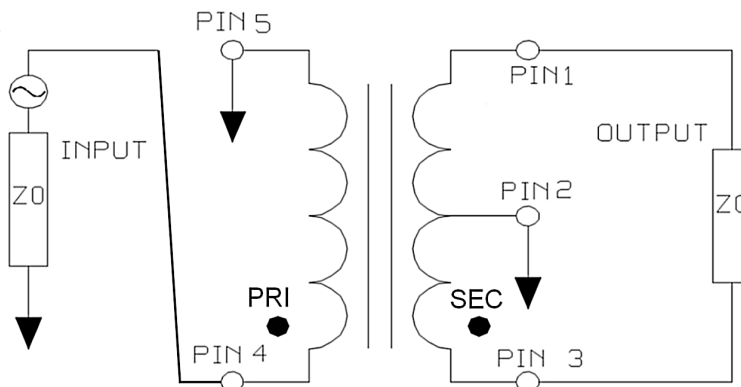

**Typical Performance Curves: Freq. = 0.3 - 200 MHz,  $T_A = 25^\circ\text{C}$ ,  $Z_0 = 50 \Omega$ ,  $P_{IN} = 0 \text{ dBm}$**

**Insertion Loss**

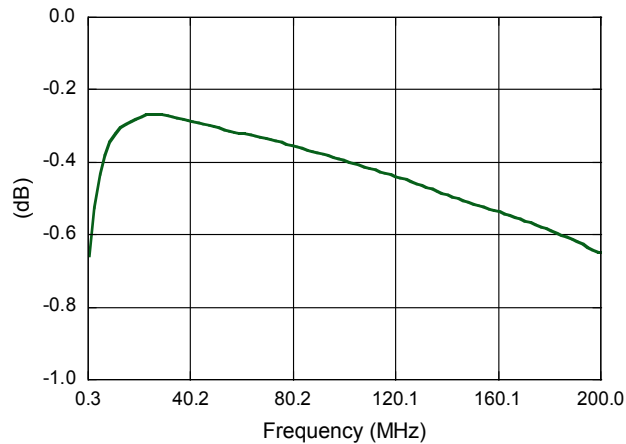

**Input Return Loss**

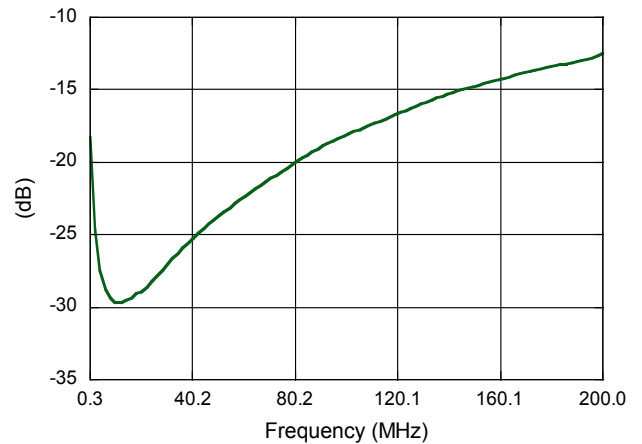

**Amplitude Balance**

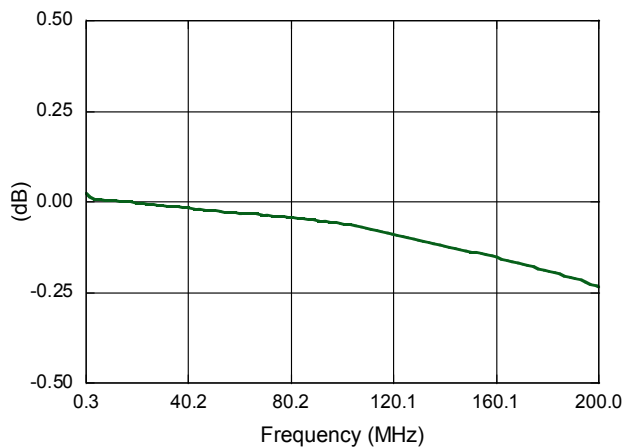

**Phase Balance**

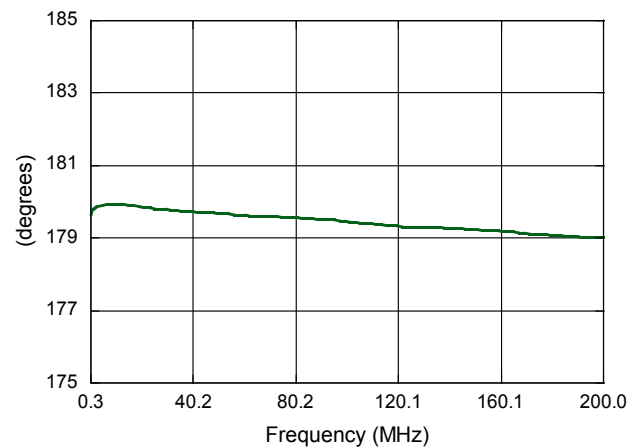

**Typical Performance Curves: Freq. = 0.3 - 200 MHz,  $T_A = 25^\circ\text{C}$ ,  $Z_0 = 75 \Omega$ ,  $P_{IN} = 0 \text{ dBm}$**

**Insertion Loss (pin 4\_3)**

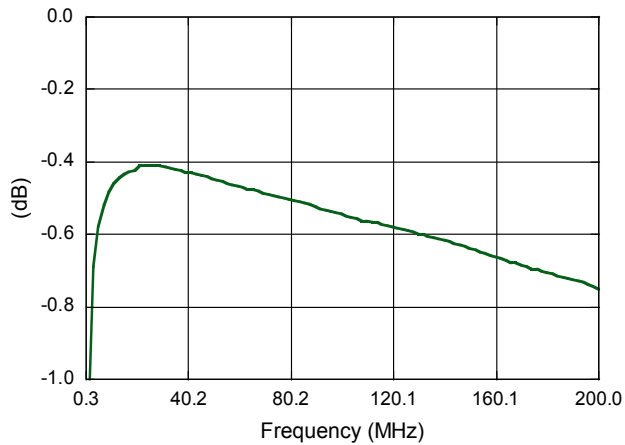

**Insertion Loss (pin 4\_1)**

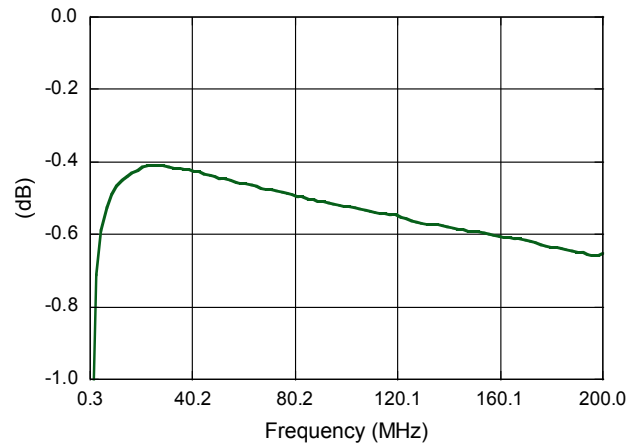

**Amplitude Balance**

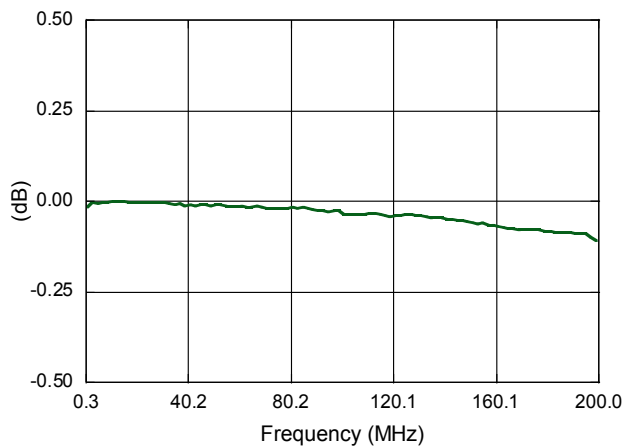

**Phase Balance**

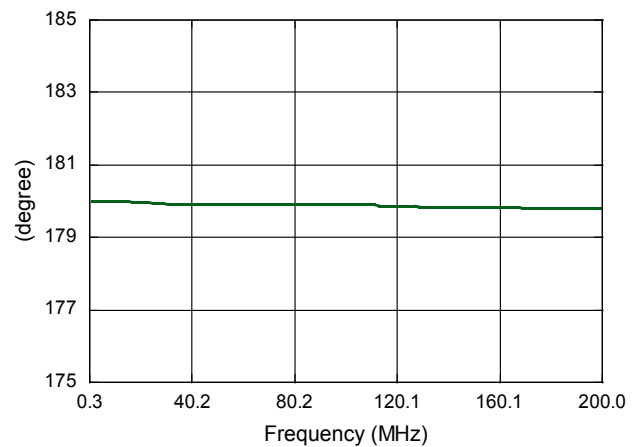

## Outline Drawing

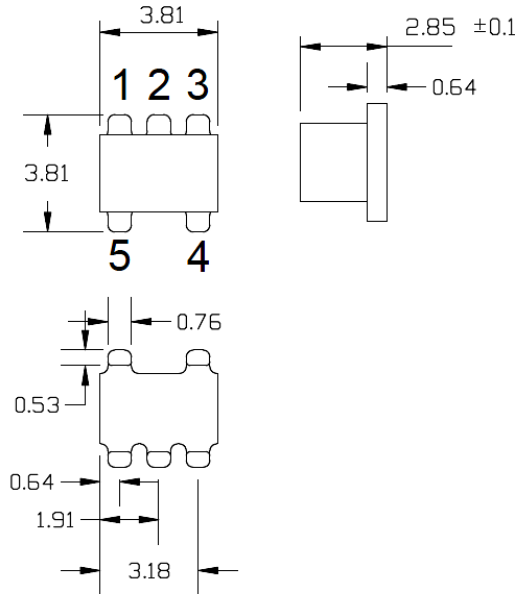

## PCB Layout

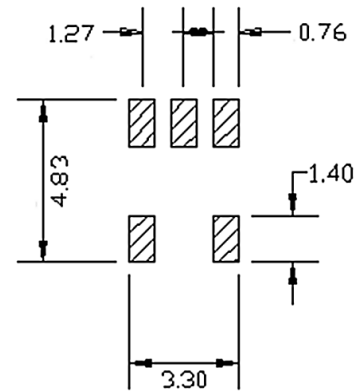

Dimensions in mm.  
 Tolerance:  $\pm 0.38$  mm unless otherwise noted.  
 Model number and lot code are printed on the reel.  
 Lead plating: ENIG on both sides, 0.05 to 0.1  $\mu$ m gold over 3 to 6  $\mu$ m nickel.

## Carrier Tape Orientation

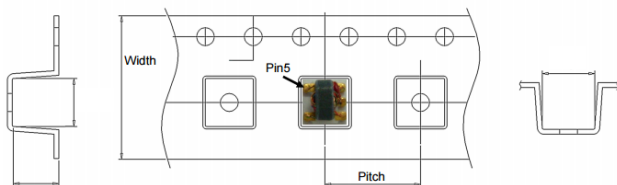

## Tape & Reel Information

Parameter	Units	Value
Qty per reel	-	2000
Reel Size	mm	330
Tape Width	mm	12
Pitch	mm	8
Orientation	-	F5
Reference Application Note ANI-019 for orientation		

MACOM Technology Solutions Inc. All rights reserved.

Information in this document is provided in connection with MACOM Technology Solutions Inc ("MACOM") products. These materials are provided by MACOM as a service to its customers and may be used for informational purposes only. Except as provided in MACOM's Terms and Conditions of Sale for such products or in any separate agreement related to this document, MACOM assumes no liability whatsoever. MACOM assumes no responsibility for errors or omissions in these materials. MACOM may make changes to specifications and product descriptions at any time, without notice. MACOM makes no commitment to update the information and shall have no responsibility whatsoever for conflicts or incompatibilities arising from future changes to its specifications and product descriptions. No license, express or implied, by estoppel or otherwise, to any intellectual property rights is granted by this document.

THESE MATERIALS ARE PROVIDED "AS IS" WITHOUT WARRANTY OF ANY KIND, EITHER EXPRESS OR IMPLIED, RELATING TO SALE AND/OR USE OF MACOM PRODUCTS INCLUDING LIABILITY OR WARRANTIES RELATING TO FITNESS FOR A PARTICULAR PURPOSE, CONSEQUENTIAL OR INCIDENTAL DAMAGES, MERCHANTABILITY, OR INFRINGEMENT OF ANY PATENT, COPYRIGHT OR OTHER INTELLECTUAL PROPERTY RIGHT. MACOM FURTHER DOES NOT WARRANT THE ACCURACY OR COMPLETENESS OF THE INFORMATION, TEXT, GRAPHICS OR OTHER ITEMS CONTAINED WITHIN THESE MATERIALS. MACOM SHALL NOT BE LIABLE FOR ANY SPECIAL, INDIRECT, INCIDENTAL, OR CONSEQUENTIAL DAMAGES, INCLUDING WITHOUT LIMITATION, LOST REVENUES OR LOST PROFITS, WHICH MAY RESULT FROM THE USE OF THESE MATERIALS.

MACOM products are not intended for use in medical, lifesaving or life sustaining applications. MACOM customers using or selling MACOM products for use in such applications do so at their own risk and agree to fully indemnify MACOM for any damages resulting from such improper use or sale.

## X-ON Electronics

Largest Supplier of Electrical and Electronic Components

*Click to view similar products for [Audio Transformers / Signal Transformers](#) category:*

*Click to view products by [MACOM](#) manufacturer:*

Other Similar products are found below :

[CX2041NLT](#) [MGPWT-00449-P](#) [PE-64961](#) [H1302FNLT](#) [H5008FNL](#) [H5012FNL](#) [H5020FNLT](#) [H5077NLT](#) [H5084FNLT](#)  
[B78476A9558A003](#) [1812WBT2-4](#) [1879479-1](#) [HX2260FNL](#) [HX5014FNL](#) [EX2024FNL](#) [FL1066](#) [T1137NLT](#) [T3012NL](#) [PE-65812FNL](#) [PE-65848FNLT](#) [H1174FNL](#) [H1302FNL](#) [H5015FNL](#) [H5019EFNL](#) [H5062FNLT](#) [CX2047LNL](#) [MGPWT-00059-P](#) [MGPWT-00266-P](#) [MGPWT-00278-P](#) [MGPWT-00431-P](#) [TTC-100](#) [TTC-143-H](#) [TTC-5032-1](#) [BX1194WNLT](#) [HX1234NLT](#) [HX5008FNLT](#) [HX5019FNL](#) [HX5084NL](#) [3-1879385-5](#) [TX1263NLT](#) [4-1879391-0](#) [T1142NL](#) [HX6101FNL](#) [HX5084FNL](#) [HX1148NL](#) [HX5020FNLT](#) [HX5014FNLT](#) [T1124NL](#)  
[1879732-1](#) [2-1879391-5](#)