

## Temperature Compensated Directional RMS Power Detector 2 - 6 GHz

Rev. V2

### Features

- Integrated Directional Coupler
- Low Insertion Loss: 0.15 dB @ 4 GHz
- Min. detectable power: -15 dBm @ 4 GHz
- Dynamic range: 45 dB @ 4 GHz
- Built-In Temperature Compensation
- Lead-Free 1.5 x 1.2 mm 6-Lead TDFN Pkg
- Halogen-Free “Green” Mold Compound
- RoHS\* Compliant and 260°C Reflow Compatible

### Description

The MACP-010561 belongs to a series of small, easy-to-use, broadband, directional detectors. With integrated low loss directional couplers and built-in temperature compensation circuits, these detectors provide an easy way to monitor the power of a signal travelling in a specific direction along a transmission line. Detectors are housed in a miniature, surface mount, lead less plastic package. They require a small amount of bias for proper performance. The total bias current is less than 0.5 mA.

Typical applications include power monitoring and leveling in Point-to-Point radios, IMS, Radar, VSAT, EW, and Aerospace & Defense systems.

The surface mount package is small yet can be handled and placed with standard pick and place assembly equipment. Detectors are fabricated on a well established GaAs process featuring full passivation for performance and reliability.

### Functional Schematic

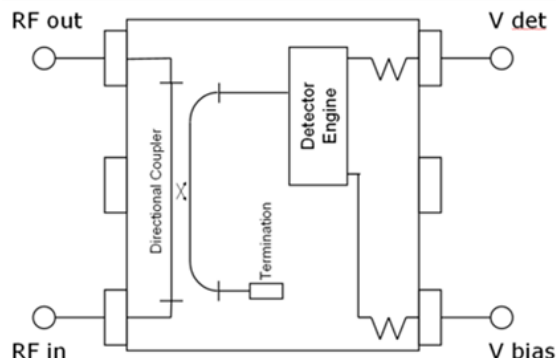

### Pin Configuration <sup>3</sup>

Pin No.	Pin Name	Description
1	RF <sub>OUT</sub>	RF Output
2	N/A	No Connection
3	RF <sub>IN</sub>	RF Input
4	V bias	Bias Voltage
5	N/A	No Connection
6	V det	Output Voltage

3. Pins 2 and 5 are not connected internally and should not be used for grounding. Package has exposed bottom metal paddle which should be connected to the circuit GROUND. The parasitic inductance introduced by this connection should be as small as possible.

### Ordering Information <sup>1,2</sup>

Part Number	Package
MACP-010561-TR1000	1000 piece reel
MACP-010561-001SMB	Sample Board

1. Reference Application Note M513 for reel size information.  
2. All sample boards include 5 loose parts.

\* Restrictions on Hazardous Substances, European Union Directive 2002/95/EC.

## Temperature Compensated Directional RMS Power Detector 2 - 6 GHz

Rev. V2

### Electrical Specifications:

Freq. = 6 GHz,  $T_A = 25^\circ\text{C}$ ,  $V_B = 3.2\text{ V}$ ,  $Z_0 = 50\ \Omega$  (unless otherwise specified)

Parameter	Test Conditions	Units	Min.	Typ.	Max.
Insertion Loss	2 GHz	dB	—	0.10	—
	4 GHz			0.15	—
	6 GHz			0.25	0.5
Detect Voltage	10 dBm applied to Input	mV	—	140	—
	2 GHz			225	—
	4 GHz			322	—
Directivity	Into 50 $\Omega$ load	dB	—	17	—
	2 GHz			19	—
	4 GHz			16	—
Sensitivity	Minimum recommended power level	dBm	—	-8	—
	2 GHz			-15	—
	4 GHz			-17	—
Maximum Power	Maximum recommended power level 2 - 6 GHz	dBm	—	30	—
Input Return Loss	2 - 6 GHz	dB	—	23	—
Output Return Loss	2 - 6 GHz	dB	—	24	—
DC Offset	Detect voltage with no RF input power	mV	50	100	150
Bias Current	$V_{\text{Bias}} = 3.2\text{ V}$	mA	—	0.3	0.35

### Absolute Maximum Ratings <sup>4,5</sup>

Parameter	Absolute Maximum
Input Power	+40 dBm
Operating Voltage	8 V
Operating Temperature	-40°C to +85°C
Storage Temperature	-65°C to +150°C

- Exceeding any one or combination of these limits may cause permanent damage to this device.
- M/A-COM Technology Solutions does not recommend sustained operation near these survivability limits.

### Handling Procedures

Please observe the following precautions to avoid damage:

### Static Sensitivity

Gallium Arsenide Integrated Circuits are sensitive to electrostatic discharge (ESD) and can be damaged by static electricity. Proper ESD control techniques should be used when handling these devices.

## Application Information

The MACP-010561 is designed to deliver high performance and to be easy to use.

No external components are needed. The RF connections required by the MACP-010561 are shown in a schematic below.

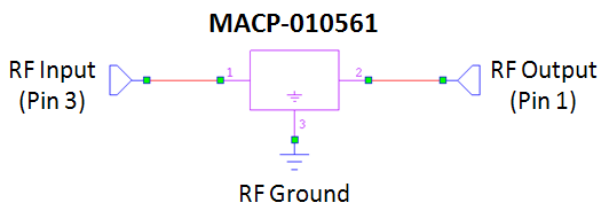

Pin 3 should be connected to the RF line bringing the input signal. Pin 1 is the RF output. The third required connection is that to the RF ground. The exposed metal paddle on the back of the package must be connected to the RF ground of the board housing the detector. This can be accomplished by using conductive via holes. It is important to ensure that the parasitic inductance associated with the connection between the detector and the RF ground is as small as possible. The RF ground also provides the return path for the DC bias current.

## DC Bias

The MACP-010561 operates with a positive 3.2 V bias applied to Pin 4. The output voltage is available on Pin 6.

## Recommended PCB Configuration

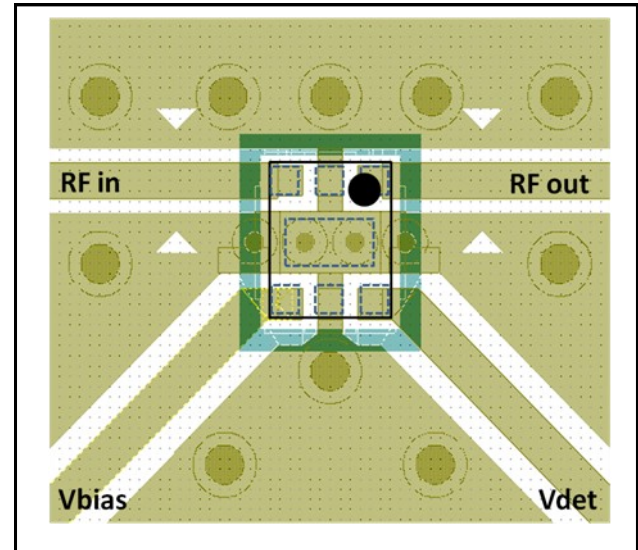

## Evaluation Board

MA-COM Technology Solutions' will supply an evaluation board and loose samples upon qualified request. The kit consists of a PCB and SMA connectors. MA-COM Technology Solutions' suggests a Rogers 4350 dielectric of .008" (0.20 mm) with ½ ounce copper. Proper grounding is always important, we suggest 8 mil (0.20 mm) vias placed generously underneath the part.

## Temperature Compensated Directional RMS Power Detector 2 - 6 GHz

Rev. V2

### Typical Performance Curves:

#### Insertion Loss

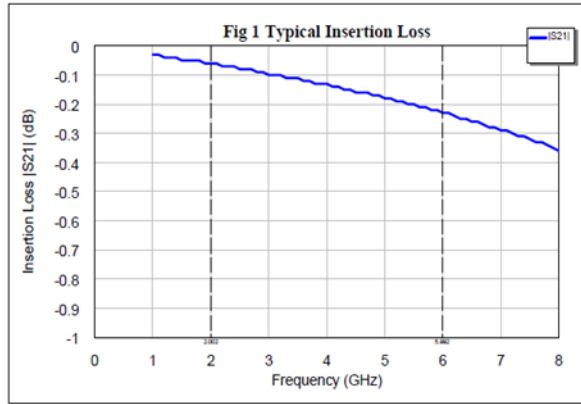

#### Detect Voltage Output vs. Input Power

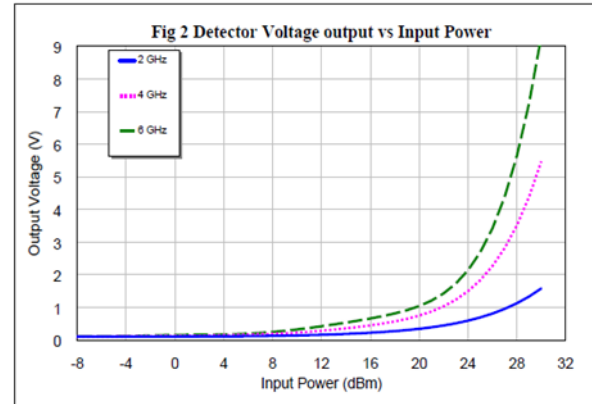

#### Input Return Loss

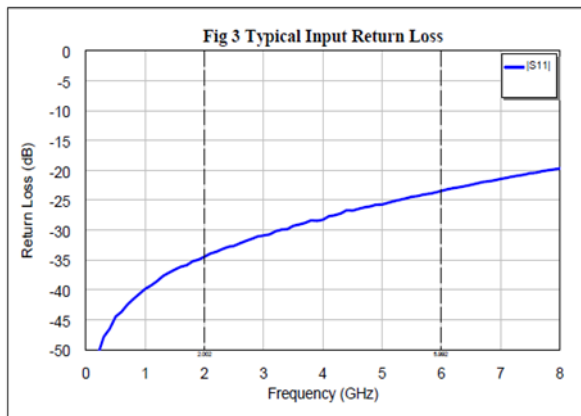

#### Output Return Loss

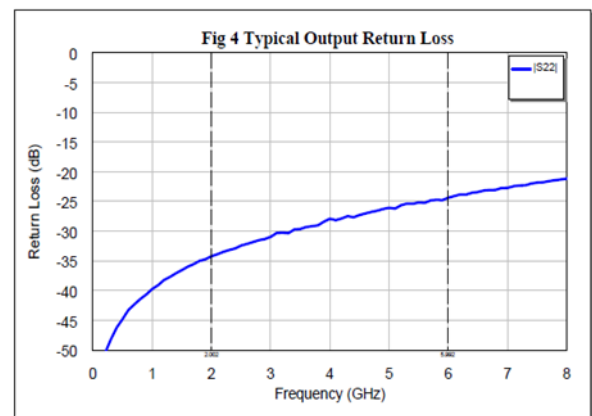

#### Directivity

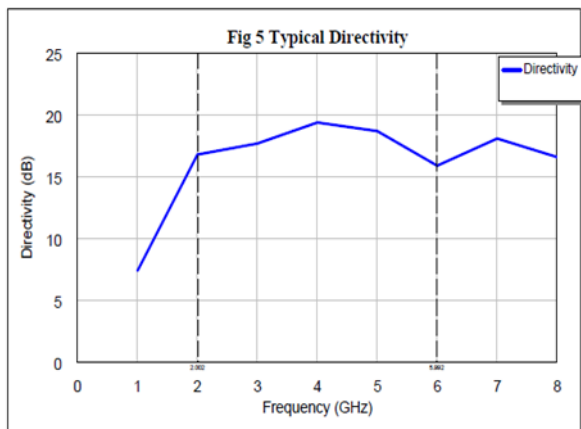

#### Detect Voltage @ 10 dBm Input Power

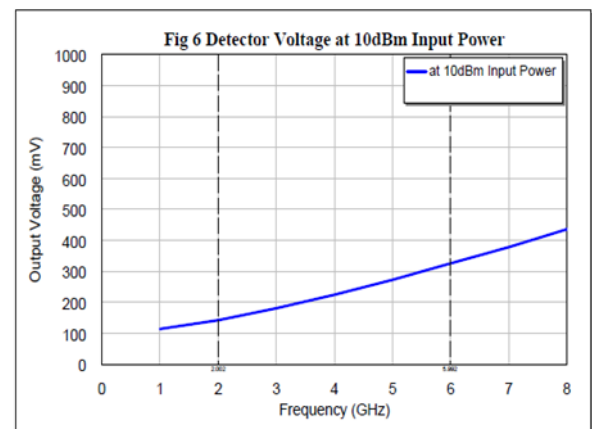

## Temperature Compensated Directional RMS Power Detector 2 - 6 GHz

Rev. V2

### Typical Performance Curves:

#### Insertion Loss

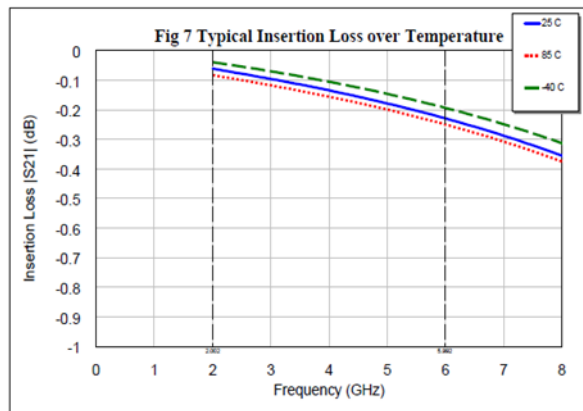

#### Detect Voltage vs. Input Power @ 4 GHz

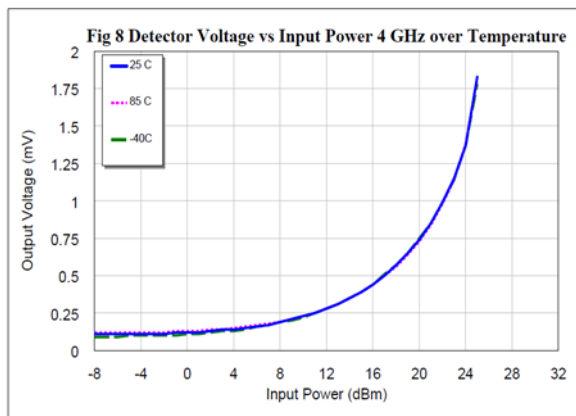

#### Input Return Loss

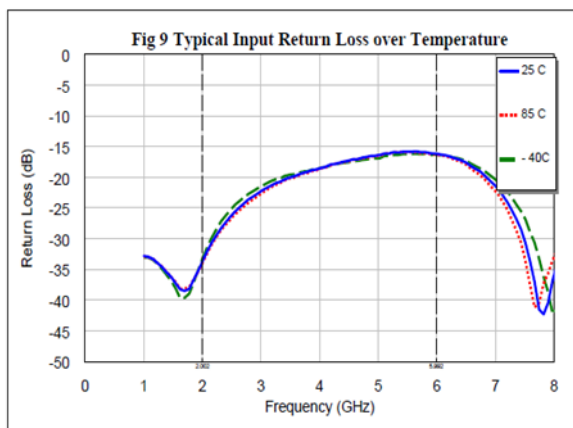

#### Output Return Loss

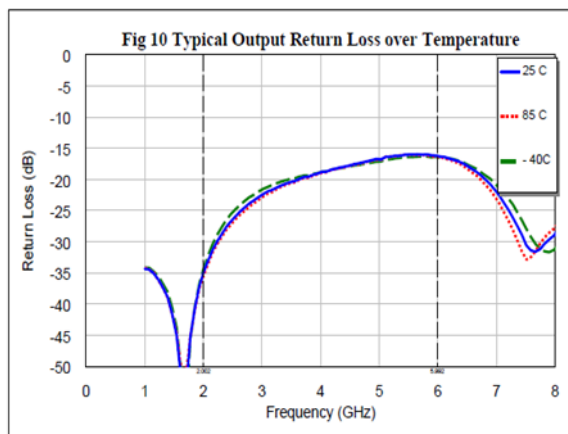

#### Directivity

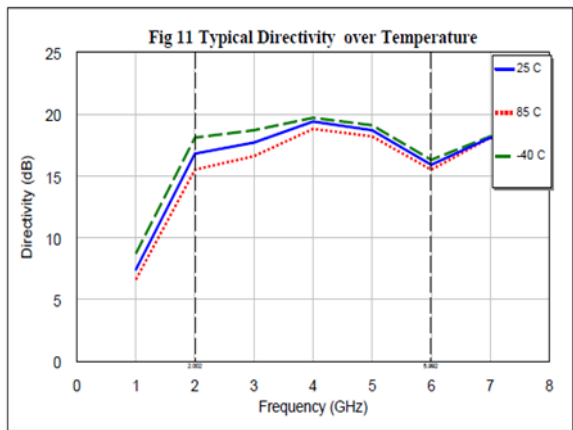

#### Temperature Compensation Accuracy

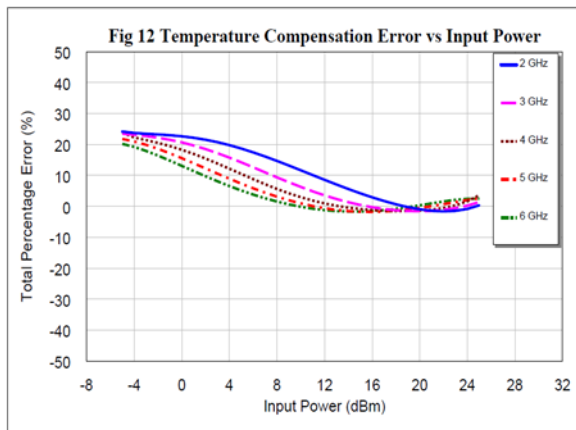

## Temperature Compensated Directional RMS Power Detector 2 - 6 GHz

Rev. V2

### Typical Performance Curves:

#### Dynamic Range (1 mV Resolution to Max Power)

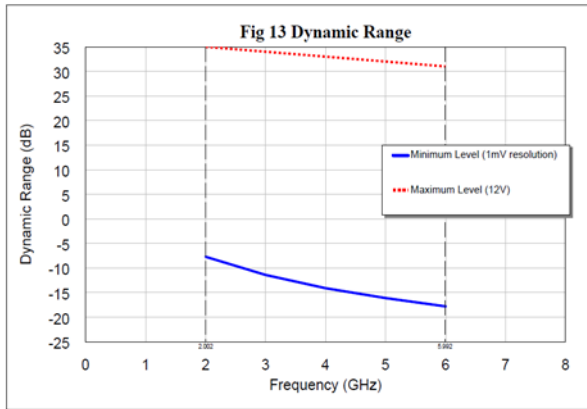

#### Detector Voltage vs. Input Power (W) @ 2 GHz

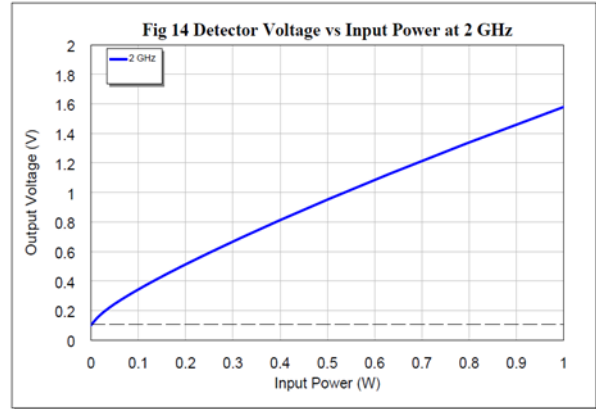

#### Detector Voltage vs. Input Power (W) @ 4 GHz

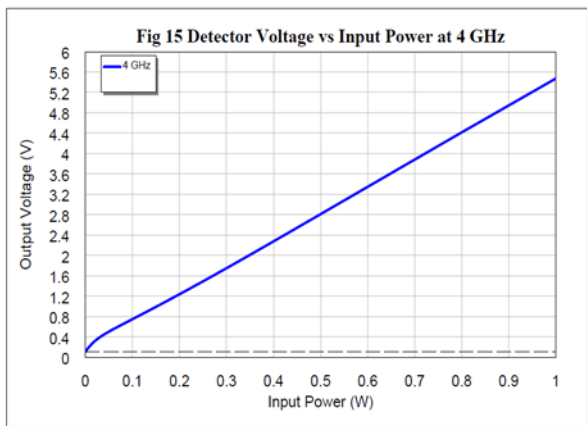

#### Detector Voltage vs. Input Power (W) @ 6 GHz

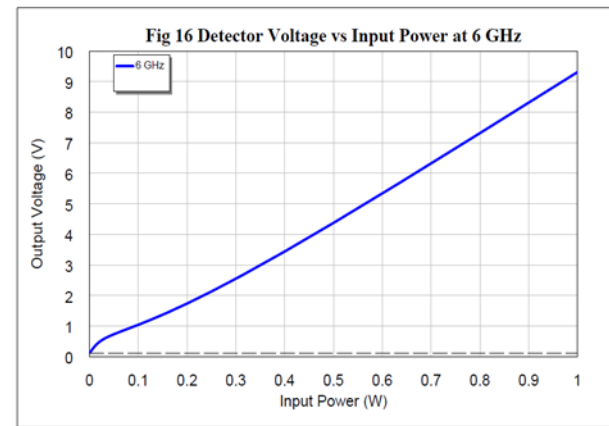

#### Frequency Response with a 2 MHz Power Pulse

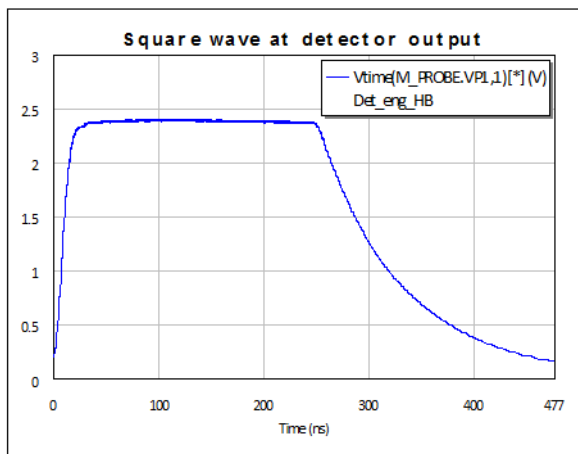

## Temperature Compensated Directional RMS Power Detector 2 - 6 GHz

Rev. V2

### Lead-Free 1.5 x 1.2 mm 6-Lead TDFN<sup>†</sup>

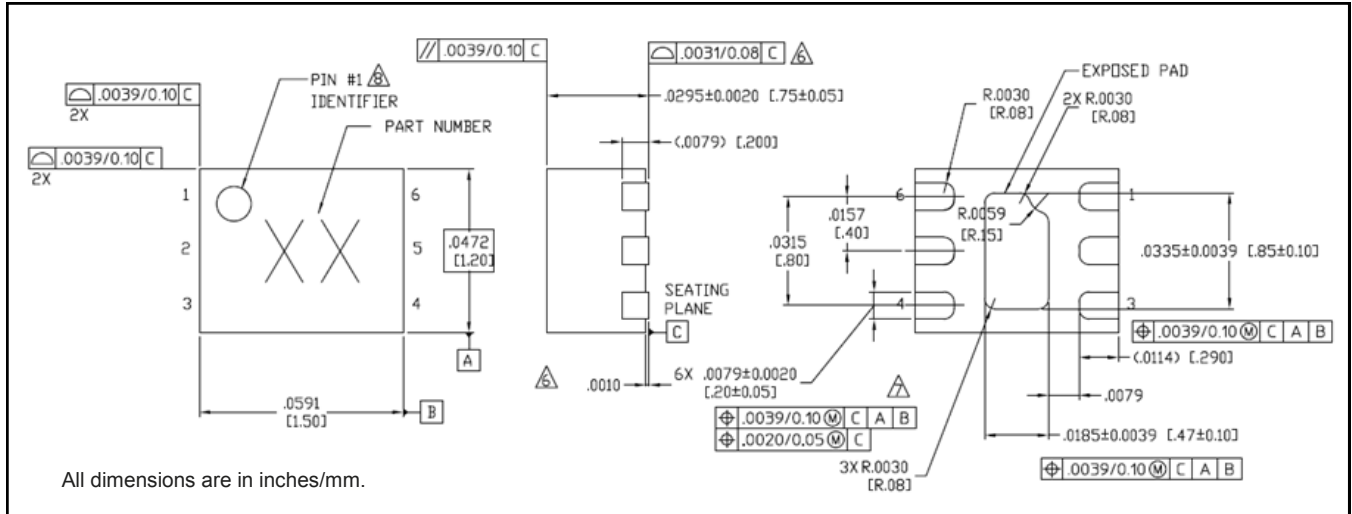

<sup>†</sup> Reference Application Note M538 for lead-free solder reflow recommendations.  
Meets JEDEC moisture sensitivity level 1 requirements.  
Plating is 100% matte tin over copper.

M/A-COM Technology Solutions Inc. All rights reserved.

Information in this document is provided in connection with M/A-COM Technology Solutions Inc ("MACOM") products. These materials are provided by MACOM as a service to its customers and may be used for informational purposes only. Except as provided in MACOM's Terms and Conditions of Sale for such products or in any separate agreement related to this document, MACOM assumes no liability whatsoever. MACOM assumes no responsibility for errors or omissions in these materials. MACOM may make changes to specifications and product descriptions at any time, without notice. MACOM makes no commitment to update the information and shall have no responsibility whatsoever for conflicts or incompatibilities arising from future changes to its specifications and product descriptions. No license, express or implied, by estoppel or otherwise, to any intellectual property rights is granted by this document.

THESE MATERIALS ARE PROVIDED "AS IS" WITHOUT WARRANTY OF ANY KIND, EITHER EXPRESS OR IMPLIED, RELATING TO SALE AND/OR USE OF MACOM PRODUCTS INCLUDING LIABILITY OR WARRANTIES RELATING TO FITNESS FOR A PARTICULAR PURPOSE, CONSEQUENTIAL OR INCIDENTAL DAMAGES, MERCHANTABILITY, OR INFRINGEMENT OF ANY PATENT, COPYRIGHT OR OTHER INTELLECTUAL PROPERTY RIGHT. MACOM FURTHER DOES NOT WARRANT THE ACCURACY OR COMPLETENESS OF THE INFORMATION, TEXT, GRAPHICS OR OTHER ITEMS CONTAINED WITHIN THESE MATERIALS. MACOM SHALL NOT BE LIABLE FOR ANY SPECIAL, INDIRECT, INCIDENTAL, OR CONSEQUENTIAL DAMAGES, INCLUDING WITHOUT LIMITATION, LOST REVENUES OR LOST PROFITS, WHICH MAY RESULT FROM THE USE OF THESE MATERIALS.

MACOM products are not intended for use in medical, lifesaving or life sustaining applications. MACOM customers using or selling MACOM products for use in such applications do so at their own risk and agree to fully indemnify MACOM for any damages resulting from such improper use or sale.



## X-ON Electronics

Largest Supplier of Electrical and Electronic Components

*Click to view similar products for [RF Detector](#) category:*

*Click to view products by [MACOM](#) manufacturer:*

Other Similar products are found below :

[HMC439QS16GTR](#) [HMC7447-SX](#) [MACP-010562-TR1000](#) [R451075000](#) [2085-6013-13](#) [2085-6010-00](#) [32-2018-BU](#) [32-3033-BU](#) [32-3203-BU](#) [AD8361ARMZ-REEL](#) [LT5534ESC6#TRPBF](#) [AD8361ARM-REEL7](#) [AD8314ARMZ-REEL](#) [AD8311ACBZ-P7](#) [AD8312ACBZ-P7](#) [AD8313ARMZ](#) [AD8313ARMZ-REEL7](#) [AD8314ACPZ-RL7](#) [AD8314ARMZ](#) [AD8314ARMZ-REEL7](#) [AD8315ARMZ](#) [AD8317ACPZ-R7](#) [AD8319ACPZ-R7](#) [AD8361ARMZ](#) [AD8361ARMZ-REEL7](#) [AD8362ARUZ-REEL7](#) [AD8302ARUZ-RL7](#) [ADL5906ACPZN-R7](#) [ADL5500ACBZ-P7](#) [ADL5502ACBZ-P7](#) [ADL5504ACBZ-P7](#) [ADL5505ACBZ-P7](#) [ADL5506ACBZ-R7](#) [ADL5506WACBZ-R7](#) [ADL5513ACPZ-R7](#) [ADL5519ACPZ-R7](#) [ADL5903ACPZN-R7](#) [ADL5903SCPZN-R7](#) [ADL6010ACPZN-R2](#) [ADL6010SCPZN](#) [ADL6010SCPZN-R7](#) [ADL6010SCPZN-R2](#) [ADL6010ACPZN](#) [ADL6012ACPZN](#) [ADL5511ACPZ-R7](#) [ADL5904ACPZN-R7](#) [ADL5910ACPZN-R7](#) [ADL5920ACPZ](#) [HMC1010LP4E](#) [HMC1021LP4E](#)