

Features

- Surface Mount
- No Wirebonds Required
- Rugged Silicon-Glass Construction
- Silicon Nitride Passivation
- Polymer Scratch Protection
- Low Parasitic Capacitance and Inductance
- High Average and Peak Power Handling
- RoHS Compliant

Description

This device is a silicon, glass PIN diode surmount chip fabricated with MACOMs' patented HMIC™ process. This device features two silicon pedestals embedded in a low loss, low dispersion glass. The diode is formed on the top of one pedestal and connections to the backside of the device are facilitated by making the pedestal sidewalls electrically conductive. Selective backside metallization is applied producing a surface mount device. This vertical topology provides for exceptional heat transfer. The topside is fully encapsulated with silicon nitride and has an additional polymer layer for scratch and impact protection. These protective coatings prevent damage to the junction and the anode air-bridge during handling and assembly.

Applications

These packageless devices are suitable for moderate incident power applications, ≤ 10 W/CW or where the peak power is ≤ 52 W, pulse width is ≤ 1 μs, and duty cycle is $\leq 0.01\%$. Their low parasitic inductance, 0.4 nH, and excellent RC constant, make these devices a superior choice for higher frequency switch elements when compared to their plastic package counterparts.

Surmount Chip^{1,2,3}

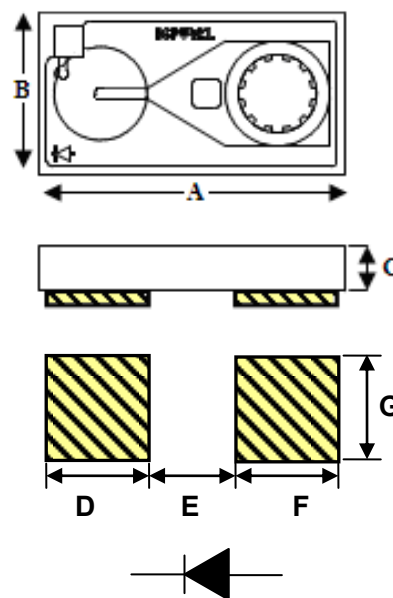

Surmount Chip Dimensions

| DIM | INCHES | | MM | |
|-----|--------|-------|-------|-------|
| | MIN. | MAX. | MIN. | MAX. |
| A | 0.040 | 0.042 | 1.025 | 1.075 |
| B | 0.021 | 0.023 | 0.525 | 0.575 |
| C | 0.004 | 0.008 | 0.102 | 0.203 |
| D | 0.013 | 0.015 | 0.325 | 0.375 |
| E | 0.011 | 0.013 | 0.275 | 0.325 |
| F | 0.013 | 0.015 | 0.325 | 0.375 |
| G | 0.019 | 0.021 | 0.475 | 0.525 |

1. Backside metal: 0.1 μm thick.
2. Yellow hatched areas indicate backside ohmic gold contacts.
3. All devices have the same outline dimensions (A to G).

Electrical Specifications @ T_A = +25°C

| Parameter | Symbol | Conditions | Units | MADP-042308 | | MADP-042508 | |
|------------------------------------|----------------|--|-------|-------------|------|-------------|------|
| | | | | Typ. | Max. | Typ. | Max. |
| Capacitance ^{4,6} | C _T | -10 V, 1 MHz | pF | 0.10 | 0.20 | 0.18 | 0.30 |
| | | -10 V, 1 GHz | | 0.10 | — | 0.19 | — |
| | | -40 V, 1 MHz | | 0.09 | 0.20 | 0.18 | 0.30 |
| | | -40 V, 1 GHz | | 0.10 | — | 0.18 | — |
| Resistance ^{5,6} | R _S | 20 mA, 1 GHz | Ω | 1.38 | — | 0.97 | — |
| | | 50 mA, 1 GHz | | 1.18 | — | 0.87 | — |
| Forward Voltage | V _F | +10 mA | V | 0.85 | 1.00 | 0.82 | 1.00 |
| Reverse Leakage Current | I _R | -100 V | μA | — | 10 | — | 10 |
| Input Third Order Intercept Point | IIP3 | F1= 1000 MHz, F2 = 1010 MHz, P _{IN} = +20 dBm, I _{BIAS} = +20 mA | dBm | 73 | — | 77 | — |
| CW Thermal Resistance ⁷ | θ | — | °C/W | 145 | — | 115 | — |
| Lifetime | T _L | +10 mA / -6 mA (50% - 90% V) | ns | 280 | — | 310 | — |

| Parameter | Symbol | Conditions | Units | MADP-042408 | | MADP-042908 | |
|------------------------------------|----------------|--|-------|-------------|------|-------------|------|
| | | | | Typ. | Max. | Typ. | Max. |
| Capacitance ^{4,6} | C _T | -10 V, 1 MHz | pF | 0.38 | 0.50 | 0.05 | 0.15 |
| | | -10 V, 1 GHz | | 0.39 | — | 0.05 | — |
| | | -40 V, 1 MHz | | 0.36 | 0.50 | 0.04 | 0.15 |
| | | -40 V, 1 GHz | | 0.37 | — | 0.05 | — |
| Resistance ^{5,6} | R _S | 20 mA, 1 GHz | Ω | 0.67 | — | 3.63 | — |
| | | 50 mA, 1 GHz | | 0.61 | — | 3.02 | — |
| Forward Voltage | V _F | +10 mA | V | 0.80 | 1.00 | 0.91 | 1.00 |
| Reverse Leakage Current | I _R | -100 V | μA | — | 10 | — | 10 |
| Input Third Order Intercept Point | IIP3 | F1= 1000 MHz, F2 = 1010 MHz, P _{IN} = +20 dBm, I _{BIAS} = +20 mA | dBm | 81 | — | 66 | — |
| CW Thermal Resistance ⁷ | θ | — | °C/W | 100 | — | 185 | — |
| Lifetime | T _L | +10 mA / -6 mA (50% - 90% V) | ns | 380 | — | 230 | — |

4. Total capacitance (C_T) is equivalent to the sum of junction capacitance (C_J) and parasitic capacitance (C_{PAR}).
5. Series resistance (R_S) is equivalent to the total diode resistance: R_S = R_J (Junction Resistance) + R_C (Ohmic Resistance).
6. R_S and C_T are measured on an HP4291A Impedance Analyzer with die mounted in an ODS-1134 package.
7. Theta (θ) is measured with the die mounted in an ODS-1134 package.

MADP-042xx8-1306x Series



SURMOUNT™ 8 μm PIN Diodes
RoHS Compliant

Rev. V3

Typical Performance @ $T_A = +25^\circ\text{C}$

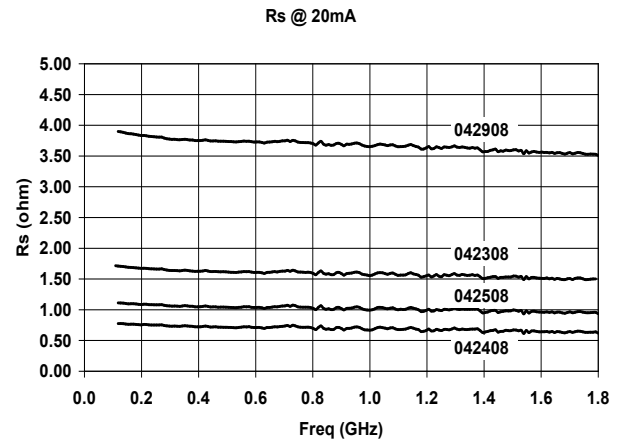
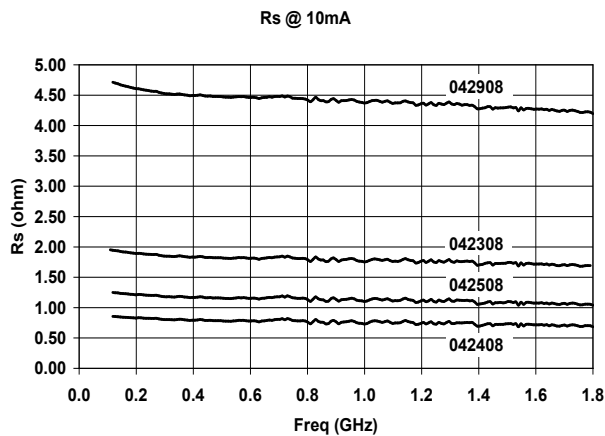
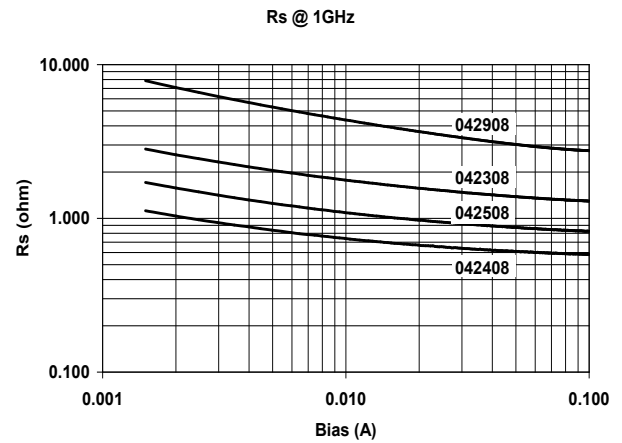
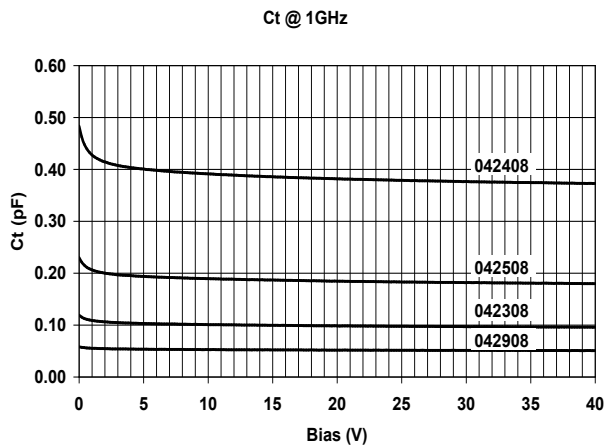
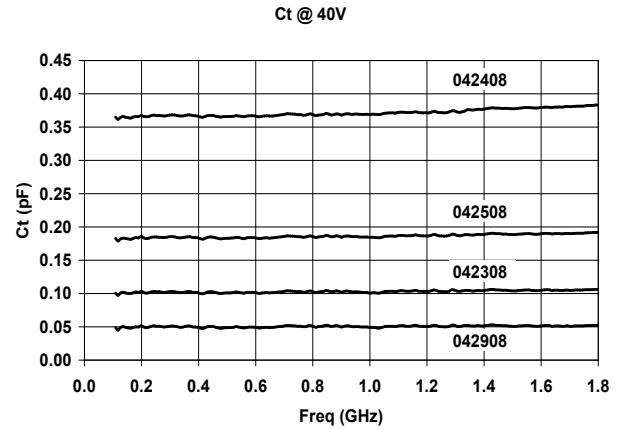
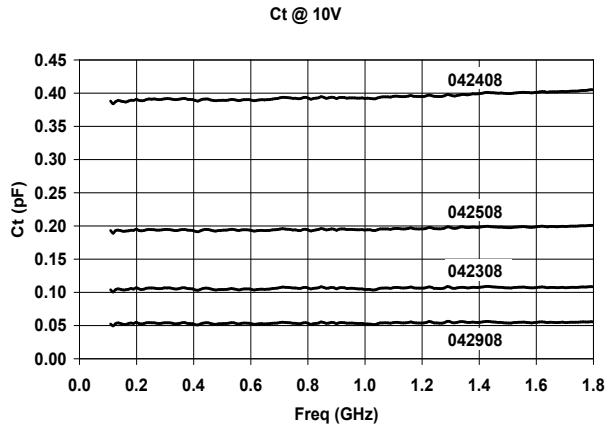

Absolute Maximum Ratings⁸ @ T_A = +25°C

| Parameter | Absolute Maximum |
|-----------------------|-----------------------|
| CW Incident Power | |
| MADP-042308 | 42 dBm |
| MADP-042408 | 44 dBm |
| MADP-042508 | 43 dBm |
| MADP-042908 | 39 dBm |
| Forward Current | 250 mA |
| Reverse Voltage | -100 V |
| Operating Temperature | -55°C to +125°C |
| Storage Temperature | -55°C to +150°C |
| Junction Temperature | +175°C |
| Mounting Temperature | +280°C for 10 seconds |

8. Exceeding these limits may cause permanent damage.

Handling Procedures

All semiconductor chips should be handled with care to avoid damage or contamination from perspiration and skin oils. The use of plastic tipped tweezers or vacuum pickups is strongly recommended for individual components. Bulk handling should insure that abrasion and mechanical shock are minimized.

Bonding Techniques

Attachment to a circuit board is made simple through the use of surface mount technology. Mounting pads are conveniently located on the bottom surface of these devices and are removed from the active junction locations. These devices are well suited for solder attachment onto hard and soft substrates. The use of 80Au/20Sn, or RoHS compliant solders is recommended. For applications where the average power is ~1 W, conductive silver epoxy may also be used. Cure per manufacturers recommended time and temperature. Typically 1 hour at 150°C.

When soldering these devices to a hard substrate, hot gas die bonding is preferred. A vacuum tip pick-up tool and a force of 60 to 100 grams applied to the top surface of the device is recommended. When soldering to soft substrates, such as Duroid, it is recommended to use a soft solder at the circuit board to mounting pad interface. Position the die so that its mounting pads are aligned with the circuit board mounting pads. While applying a downward force perpendicular to the top surface of the die, apply heat near the circuit trace and diode mounting pad. The solder connection to the two pads should not be made one at a time as this will create unequal heat flow and thermal stress to the part. Solder reflow should not be performed by causing heat to flow through the top surface of the die to the back. Since the HMIC glass is transparent, the edges of the mounting pads can be visually inspected through the die after attachment is completed.

Typical re-flow profiles for Sn60/Pb40 and RoHS compliant solders is provided in [Application Note M538](#), "Surface Mounting Instructions" and can viewed @ www.macom.com.

Ordering Information⁹

| Part Number | |
|--------------------|-----------------------------|
| Gel Pack | Tape and Reel (Pocket Tape) |
| MADP-042308-130600 | MADP-042308-13060P |
| MADP-042408-130600 | MADP-042408-13060P |
| MADP-042508-130600 | MADP-042508-13060P |
| MADP-042908-130600 | MADP-042908-13060P |

9. Reference Application Note M513 for reel size information.

MACOM Technology Solutions Inc. All rights reserved.

Information in this document is provided in connection with MACOM Technology Solutions Inc ("MACOM") products. These materials are provided by MACOM as a service to its customers and may be used for informational purposes only. Except as provided in MACOM's Terms and Conditions of Sale for such products or in any separate agreement related to this document, MACOM assumes no liability whatsoever. MACOM assumes no responsibility for errors or omissions in these materials. MACOM may make changes to specifications and product descriptions at any time, without notice. MACOM makes no commitment to update the information and shall have no responsibility whatsoever for conflicts or incompatibilities arising from future changes to its specifications and product descriptions. No license, express or implied, by estoppel or otherwise, to any intellectual property rights is granted by this document.

THESE MATERIALS ARE PROVIDED "AS IS" WITHOUT WARRANTY OF ANY KIND, EITHER EXPRESS OR IMPLIED, RELATING TO SALE AND/OR USE OF MACOM PRODUCTS INCLUDING LIABILITY OR WARRANTIES RELATING TO FITNESS FOR A PARTICULAR PURPOSE, CONSEQUENTIAL OR INCIDENTAL DAMAGES, MERCHANTABILITY, OR INFRINGEMENT OF ANY PATENT, COPYRIGHT OR OTHER INTELLECTUAL PROPERTY RIGHT. MACOM FURTHER DOES NOT WARRANT THE ACCURACY OR COMPLETENESS OF THE INFORMATION, TEXT, GRAPHICS OR OTHER ITEMS CONTAINED WITHIN THESE MATERIALS. MACOM SHALL NOT BE LIABLE FOR ANY SPECIAL, INDIRECT, INCIDENTAL, OR CONSEQUENTIAL DAMAGES, INCLUDING WITHOUT LIMITATION, LOST REVENUES OR LOST PROFITS, WHICH MAY RESULT FROM THE USE OF THESE MATERIALS.

MACOM products are not intended for use in medical, lifesaving or life sustaining applications. MACOM customers using or selling MACOM products for use in such applications do so at their own risk and agree to fully indemnify MACOM for any damages resulting from such improper use or sale.

X-ON Electronics

Largest Supplier of Electrical and Electronic Components

Click to view similar products for [PIN Diodes](#) category:

Click to view products by [MACOM](#) manufacturer:

Other Similar products are found below :

[MA45471](#) [MA4SPS502](#) [APD2220-000](#) [APD0810-000](#) [MA4GP907](#) [MA4L032-186](#) [MA4L401-30](#) [MA4P606-258](#) [MA4P7435NM-1091T](#)
[MA4PK2000](#) [MA4PK2001](#) [MA4PK2004](#) [MADP-007167-12250T](#) [MADP-030025-13140P](#) [MA4SPS421](#) [MA4PBL027](#) [MA4P404-30](#)
[MA4AGFCP910](#) [MA4P7101F-1072T](#) [MA4L022-30](#) [MA47047-54](#) [BAR 89-02LRH E6327](#) [UM7108B](#) [UM9701](#) [1SV308,L3F](#) [UM9301SM](#)
[5082-3077](#) [GC4723-42](#) [MA4L011-1088](#) [MSW2001-200](#) [SMP1321-000](#) [M17X1008](#) [UM4010SM](#) [UM6002B](#) [UM7006A](#) [UM7006B](#)
[UM7108C](#) [GC4742-42](#) [MADP-000015-000030](#) [MGPN1503-C01A](#) [UMX512](#) [LXP1000-23-2](#) [LXP1004-23-2](#) [MPP4205A-206](#) [MPP4201-206](#)
[LXP1002-23-0](#) [LXP1004-23-0](#) [MPP4202-206](#) [MPP4205-206](#) [MPC8050-206](#)