

Features

- Integrates Image Reject (Balanced) Mixer, LO Buffer, LO Doubler, and RF Buffer
- 12 dB Conversion Gain
- 20 dBm Input Third Order Intercept (IIP3)
- -45 dBm (2x) LO Leakage (at RF Port)
- Variable Gain with Adjustable Bias
- Lead-Free 4 mm, 24 Lead QFN Package
- RoHS[^] Compliant and 260°C Reflow Compatible

Description

The MAUC-011003 is an integrated up-converter assembled in a lead-free 4 mm 24-lead PQFN plastic package. This device has a typical conversion gain of 12 dB, and an image rejection of 15 dBc. This up-converter includes a LO doubler, LO buffer amplifier, and RF buffer amplifier. Variable gain can be achieved by adjusting the bias, with turn-down trajectories optimized to maintain linearity and 2xLO leakage over the gain control range. The output IP3 is 32 dBm at maximum gain.

The MAUC-011003 is ideally suited for 28 and 32 GHz band point-to-point radios under both LSB and USB operation and Ka-Band VSAT applications.

Each device is 100% RF tested to ensure performance compliance.

Ordering Information¹

Part Number	Package
MAUC-011003-TR0500	500 Piece Reel
MAUC-011003-001SMB	Sample Board

1. Reference Application Note M513 for reel size information.

Functional Schematic

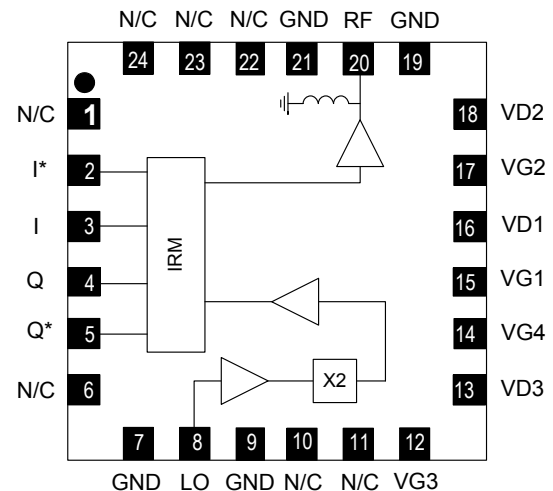

Pin Configuration²

Pin No.	Function	Pin No.	Function
1	N/C	13	VD3
2	I*	14	VG4
3	I	15	VG1
4	Q	16	VD1
5	Q*	17	VG2
6	N/C	18	VD2
7	GND	19	GND
8	LO	20	RF
9	GND	21	GND
10	N/C	22	N/C
11	N/C	23	N/C
12	VG3	24	N/C
		25	Paddle ³

2. For optimum RF performance, all N/C's should be terminated to ground.

3. The exposed pad centered on the package bottom must be connected to RF, DC and thermal ground.

¹ ^ Restrictions on Hazardous Substances, European Union Directive 2011/65/EU.

Electrical Specifications: LO = 0 dBm, IF = -10 dBm @ 2 GHz,
 $V_{D1,2^4} = 4\text{ V}$, $V_{D3^4} = 3\text{ V}$, $I_{D1} + I_{D2} = 240\text{ mA}$, $I_{D3} = 140\text{ mA}$, $V_{G4} = -3\text{ V}$, $T_A = 25^\circ\text{C}$

Parameter	Units	Min.	Typ.	Max.
Frequency Range (RF)	GHz	27.5	-	33.4
Frequency Range (LO)	GHz	12	-	18.45
LO Input Power (PLO)	dBm	-	0	-
Conversion Gain	dB	8.5	12.0	14.0
Image Rejection	dBc	-	15	-
Input IP3	dBm	-	20	-
Output IP3 ($P_{IN} = -10\text{ dBm/ tone}$)	dBm	28	32	-
Spurious (2xLO) [tuned - IF voltages ~ 0.2 V]	dBm	-	-45	-
Spurious (1xLO)	dBm	-	-55	-
Gate Voltages (V_{G1}, V_{G2}, V_{G3}) ⁴	V	-1.0	-	-0.1
Gate Current ($I_{G1} + I_{G2}$)	mA	-2.0	-	0
Gate Current (I_{G3})	mA	-0.5	-	0

4. Apply gate voltages prior to drain voltages. First turn on $V_{G4} = -3\text{ V}$. Then adjust V_{G1} , V_{G2} and V_{G3} between -1.0 and -0.1 V to achieve specified drain current. Typical current (380 mA) = 240 ($I_{D1} + I_{D2}$) + 140 (I_{D3}). Refer to App Note [1] for biasing details.

Absolute Maximum Ratings^{5,6,7}

Parameter	Absolute Max.
Drain Voltage	4.3 V
Gate Bias Voltage ($V_{G1,2,3}$)	-1.5 V < V_G < 0 V
Gate Bias Voltage (V_{G4})	-4.0 V < V_G < 0 V
Input Power	10 dBm
LO Input Power	13 dBm
Storage Temperature	-55°C to +150°C
Operating Temperature	-40°C to +85°C
Junction Temperature	+150°C

- Exceeding any one or combination of these limits may cause permanent damage to this device.
- MACOM does not recommend sustained operation near these survivability limits.
- Operating at nominal conditions with $T_J \leq +150^\circ\text{C}$ will ensure $\text{MTTF} > 1 \times 10^6$ hours.

Handling Procedures

Please observe the following precautions to avoid damage:

Static Sensitivity

These electronic devices are sensitive to electrostatic discharge (ESD) and can be damaged by static electricity. Proper ESD control techniques should be used when handling these static sensitive devices.

Typical Performance Curves: LO = 0 dBm, IF = -10 dBm @ 2 GHz, P_{DC} = 1.38 W

Conversion Gain

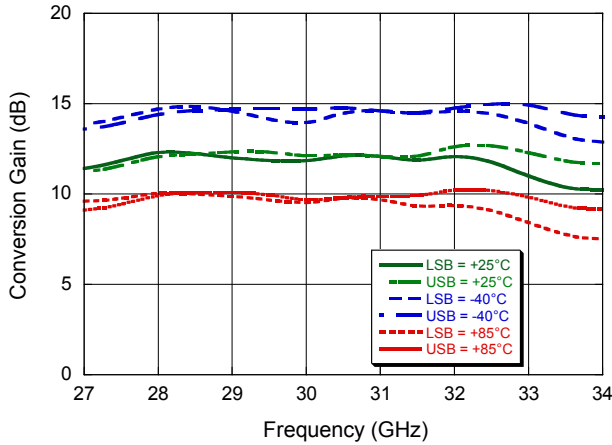

Conversion Gain @ 27.5 GHz

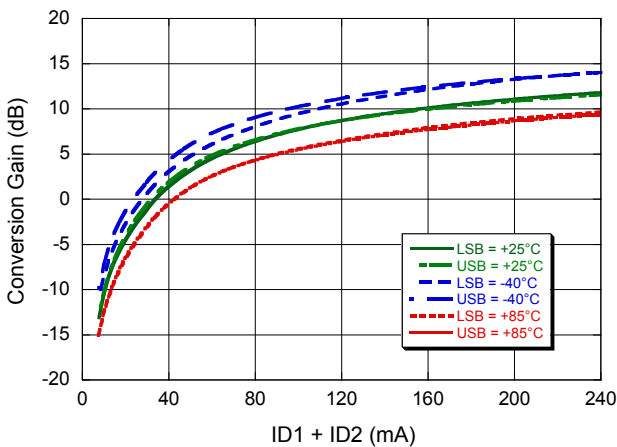

Conversion Gain @ 33.5 GHz

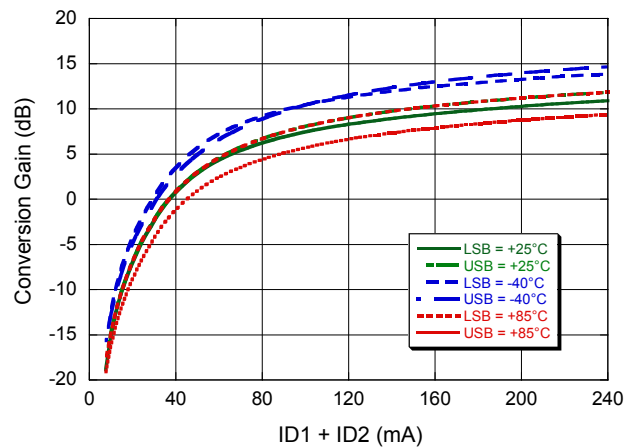

Conversion Gain @ 27.5 GHz

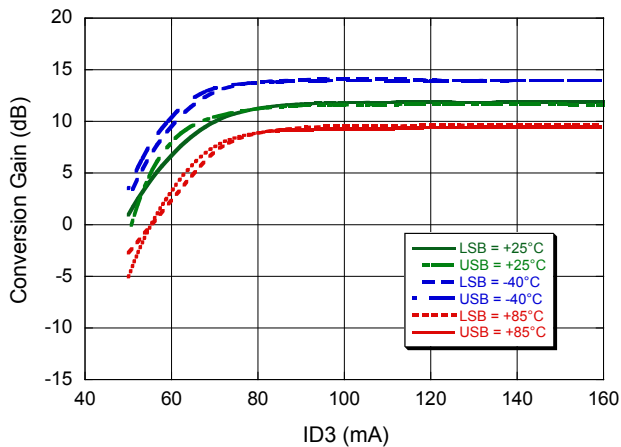

Conversion Gain @ 33.5 GHz

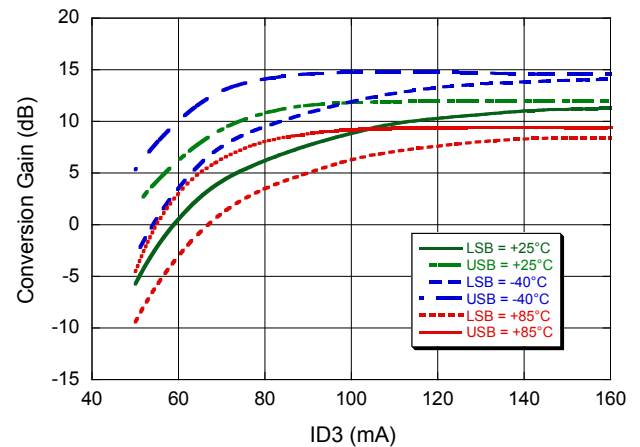

Typical Performance Curves: LO = 0 dBm, IF = -10 dBm @ 2 GHz, P_{DC} = 1.38 W

Input IP3

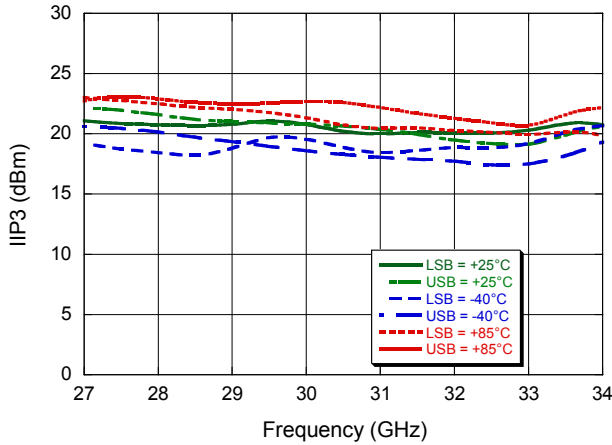

Input IP3 @ 27.5 GHz

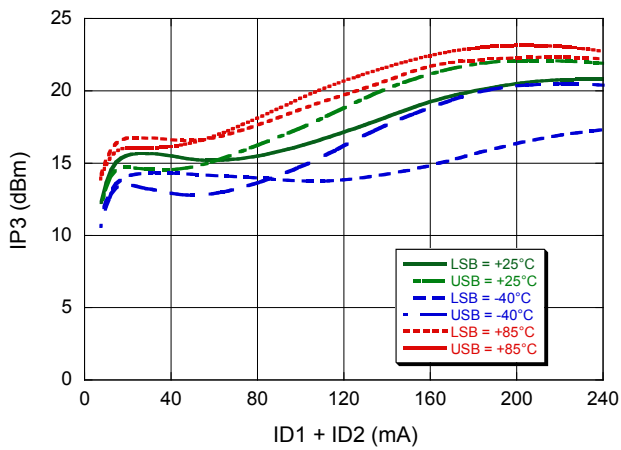

Input IP3 @ 33.5 GHz

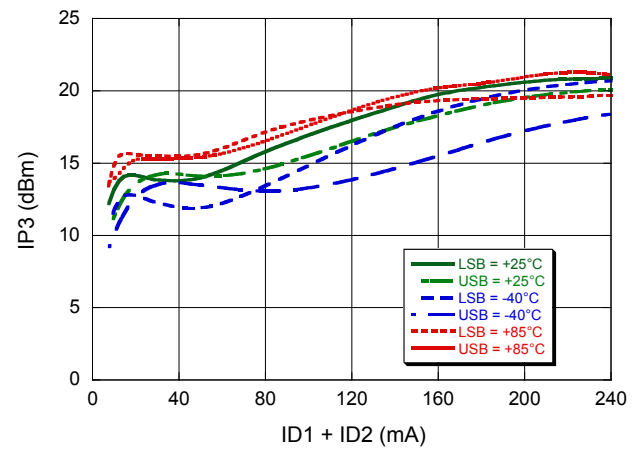

Input IP3 @ 27.5 GHz

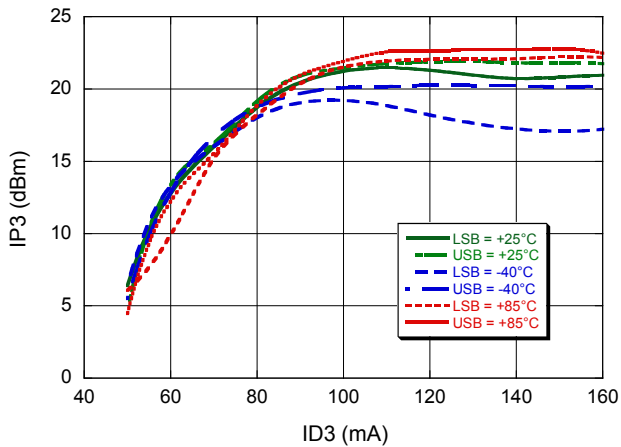

Input IP3 @ 33.5 GHz

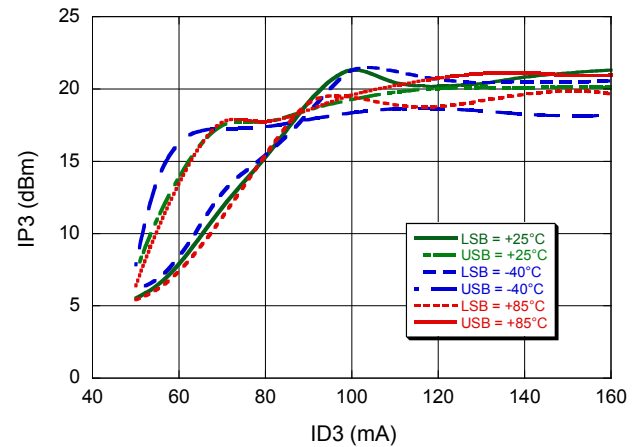

Typical Performance Curves: LO = 0 dBm, IF = -10 dBm @ 2 GHz, P_{DC} = 1.38 W

2xLO Leakage

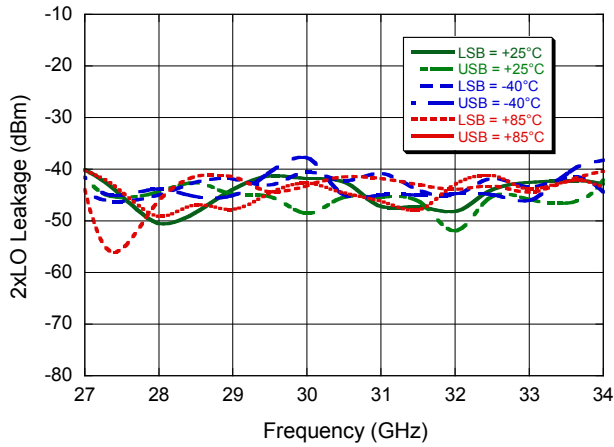

1xLO Leakage

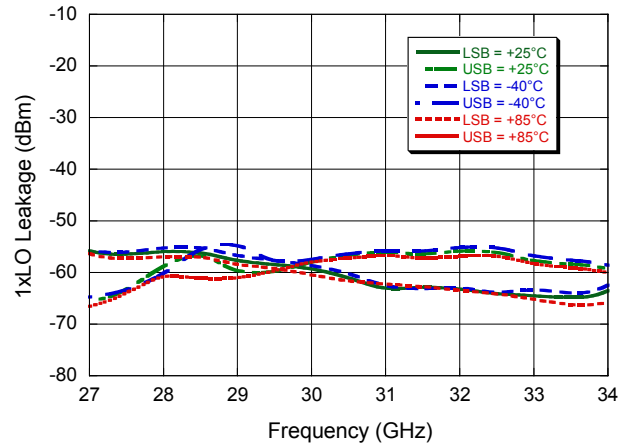
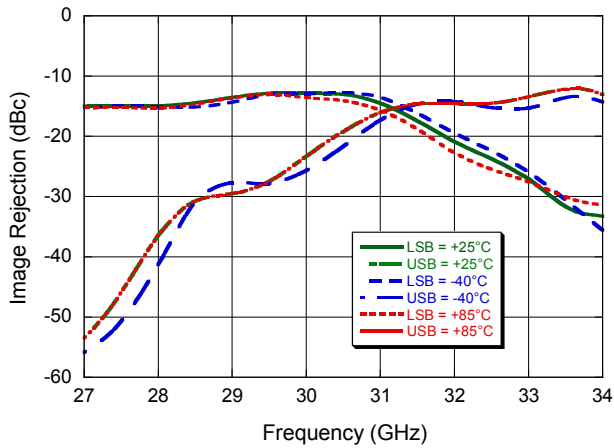

Image Rejection



App Note [3] Board Layout

As shown in the recommended board layout, it is recommended to provide 100 pF decoupling capacitors as close to the bias pins as possible. Additional 10 nF (C1 - C7) and 1 μ F (C8 - C14) on each of the bias lines are recommended placed a distance further away.

Recommended Board Layout

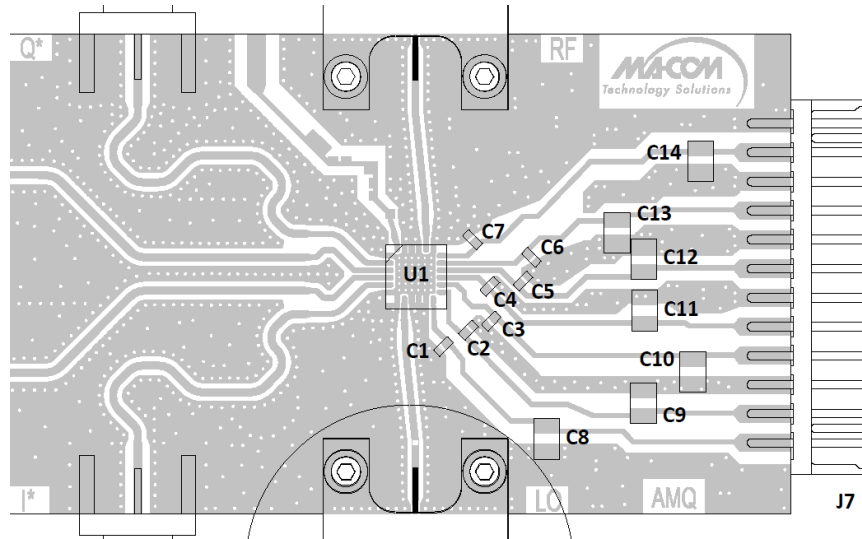

App Note [4] IF Bias Tuning

To obtain optimum 2xLO leakage performance, tuning is achieved by adjusting the DC bias on each of the IF inputs (I, Q, I*, Q*). DC bias is implemented by adding simple bias tees to each of the four IF ports. The diagram below shows a typical bias tee design used.

If the I and Q ports are used for the IF input, the I* and Q* ports are DC biased and terminated into 50 Ω . A typical tuning arrangement is to apply a fixed 0.3 V DC bias to both the used IF input ports: I, Q. The remaining two IF ports which have been terminated to 50 Ω tuning independently for minimum 2xLO leakage.

For minimum 2xLO leakage in a system, it may be necessary to correct the IF DC bias for different frequency and temperature conditions. This can be implemented by calibration and offset tables stored in memory, and used to control IF bias over all practical conditions.

Typical Configuration

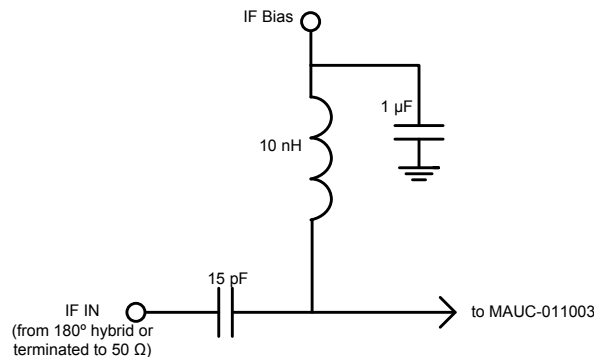

Lead-Free 4 mm 24-Lead PQFN †

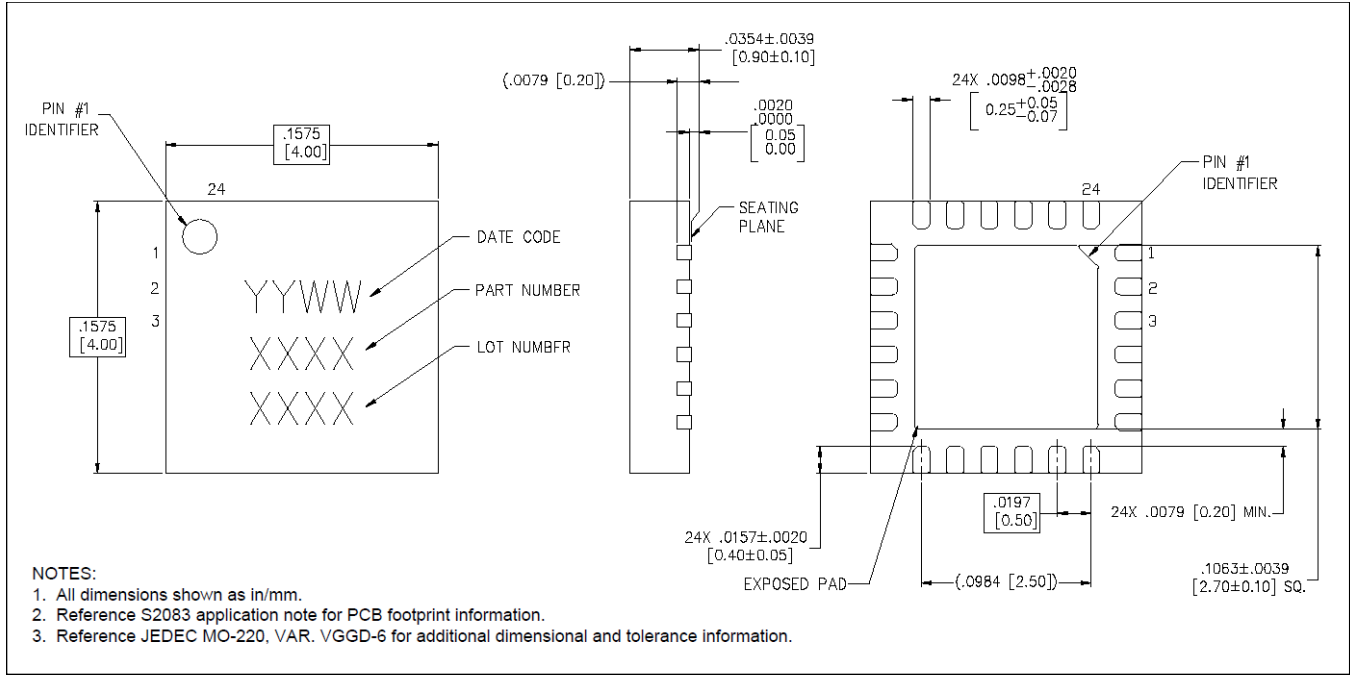

† Reference Application Note S2083 for lead-free solder reflow recommendations.
Meets JEDEC moisture sensitivity level 1 requirements.
Plating is 100% matte tin.

M/A-COM Technology Solutions Inc. All rights reserved.

Information in this document is provided in connection with M/A-COM Technology Solutions Inc ("MACOM") products. These materials are provided by MACOM as a service to its customers and may be used for informational purposes only. Except as provided in MACOM's Terms and Conditions of Sale for such products or in any separate agreement related to this document, MACOM assumes no liability whatsoever. MACOM assumes no responsibility for errors or omissions in these materials. MACOM may make changes to specifications and product descriptions at any time, without notice. MACOM makes no commitment to update the information and shall have no responsibility whatsoever for conflicts or incompatibilities arising from future changes to its specifications and product descriptions. No license, express or implied, by estoppel or otherwise, to any intellectual property rights is granted by this document.

THESE MATERIALS ARE PROVIDED "AS IS" WITHOUT WARRANTY OF ANY KIND, EITHER EXPRESS OR IMPLIED, RELATING TO SALE AND/OR USE OF MACOM PRODUCTS INCLUDING LIABILITY OR WARRANTIES RELATING TO FITNESS FOR A PARTICULAR PURPOSE, CONSEQUENTIAL OR INCIDENTAL DAMAGES, MERCHANTABILITY, OR INFRINGEMENT OF ANY PATENT, COPYRIGHT OR OTHER INTELLECTUAL PROPERTY RIGHT. MACOM FURTHER DOES NOT WARRANT THE ACCURACY OR COMPLETENESS OF THE INFORMATION, TEXT, GRAPHICS OR OTHER ITEMS CONTAINED WITHIN THESE MATERIALS. MACOM SHALL NOT BE LIABLE FOR ANY SPECIAL, INDIRECT, INCIDENTAL, OR CONSEQUENTIAL DAMAGES, INCLUDING WITHOUT LIMITATION, LOST REVENUES OR LOST PROFITS, WHICH MAY RESULT FROM THE USE OF THESE MATERIALS.

MACOM products are not intended for use in medical, lifesaving or life sustaining applications. MACOM customers using or selling MACOM products for use in such applications do so at their own risk and agree to fully indemnify MACOM for any damages resulting from such improper use or sale.

X-ON Electronics

Largest Supplier of Electrical and Electronic Components

Click to view similar products for [Up-Down Converters](#) category:

Click to view products by [MACOM](#) manufacturer:

Other Similar products are found below :

[HMC7586-SX](#) [HMC7587](#) [HMC8119-SX](#) [HMC7587-SX](#) [HMC6147ALC5ATR](#) [MDS-158-PIN](#) [LA8153QA-WH](#) [HMC7912LP5ETR](#)
[HMC377QS16GETR](#) [MY87C](#) [CSM2-10](#) [CHR3762-QDG](#) [AD6620ASZ-REEL](#) [ADF5904ACPZ](#) [ADF5904WCCPZ](#) [AD6623ASZ](#)
[AD6633BBCZ](#) [AD6634BBCZ](#) [AD9957BSVZ](#) [AD9957BSVZ-REEL](#) [ADMV1009AEZ](#) [ADMV1010AEZ](#) [ADMV1011AEZ](#) [ADMV1012AEZ](#)
[ADRF6658BCPZ](#) [HMC951ALP4E](#) [HMC1190ALP6NE](#) [HMC571](#) [HMC6146BLC5A](#) [HMC6146BLC5ATR](#) [HMC571LC5](#) [HMC572LC5](#)
[HMC925LC5](#) [HMC6787ALC5A](#) [HMC6787ALC5ATR](#) [HMC683LP6CE](#) [HMC682LP6CE](#) [HMC571LC5TR](#) [HMC7911LP5E](#) [HMC7912LP5E](#)
[HMC908ALC5](#) [HMC966LP4E](#) [HMC967LP4E](#) [HMC977LP4E](#) [AD6634BBC](#) [HMC6505ALC5](#) [MAUC-011003-TR0500](#) [MAX19996AETP+](#)
[MAX2039ETP+](#) [MAX2410EEI+](#)