

GaN on Silicon Power Amplifier 20 - 2500 MHz, 28 V, 10 W

Rev. V2

Features

- GaN on Si HEMT D-Mode Amplifier
- Suitable for Linear & Saturated Applications
- Broadband Operation from 20 - 2500 MHz
- 28 V Operation
- 12.5 dB Gain @ 2500 MHz
- 43% Drain Efficiency @ 2500 MHz
- 100% RF Tested
- Fully Matched at Input, Unmatched at Output
- Lead-Free 6 x 5 mm 8-lead PDFN Package
- Halogen-Free “Green” Mold Compound
- RoHS* Compliant



Description

The NPA1007 is a GaN on silicon power amplifier optimized for 20 - 2500 MHz operation. This amplifier has been designed for saturated and linear operation and it is assembled in a lead-free 6 x 5 mm 8-lead PDFN plastic package.

The NPA1007 is a general purpose device suited for narrowband and broadband applications in test and measurement, defense communications, land mobile radio and wireless infrastructure.

Functional Schematic

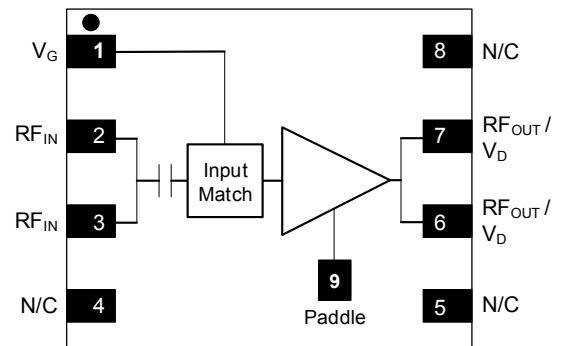

Ordering Information^{1,2}

Part #	Package
NPA1007	Bulk
NPA1007-TR0500	500 Piece Reel
NPA1007-TR0100	100 Piece Reel
NPA1007-SMB	Evaluation Board

1. All sample boards include a part soldered down to the board.
2. Reference Application Note M513 for reel size information.

Pin Configuration

Pin #	Pin Name	Function
1	V _G	Gate Voltage
2, 3	RF _{IN}	RF Input
4, 5	N/C ³	No Connection
6, 7	RF _{OUT} / V _D	RF Output / Drain Voltage
8	N/C ³	No Connection
9	Paddle ⁴	Ground

3. All no connection pins may be left floating or connected to ground.
4. The exposed pad centered on the package bottom must be connected to RF and DC ground. This path must also provide a low thermal resistance heat path.

¹ * Restrictions on Hazardous Substances, compliant to current RoHS EU directive.

GaN on Silicon Power Amplifier 20 - 2500 MHz, 28 V, 10 W

Rev. V2

RF Electrical Specifications, CW Performance⁵: $T_A = 25^\circ\text{C}$, $V_{DS} = 28\text{ V}$, $I_{DQ} = 130\text{ mA}$, $Z_O = 50\ \Omega$

Parameter	Test Conditions	Symbol	Min.	Typ.	Max.	Units
Small Signal Gain	$P_{IN} = 0\text{ dBm}$, 2500 MHz	G_{SS}	-	12.5	-	dB
Power Gain	$P_{IN} = 30\text{ dBm}$, 2500 MHz	G_P	-	10.5	-	dB
Drain Efficiency	$P_{IN} = 30\text{ dBm}$, 2500 MHz	η_D	-	43	-	%
Input Return Loss	$P_{IN} = 30\text{ dBm}$, 2500 MHz	IRL	-	-14	-	dB
Load Mismatch Tolerance	No Oscillation and Damage at all Phase Angles and Power Levels	$VSWR_T$	-	-	10:1	ratio

5. Performance in MACOM Evaluation Board.

RF Electrical Specifications, Pulsed Performance⁶: $T_A = 25^\circ\text{C}$, $V_{DS} = 28\text{ V}$, $I_{DQ} = 130\text{ mA}$, $Z_O = 50\ \Omega$, RF Pulse Width = 100 μs , Duty Cycle = 10 %

Parameter	Test Conditions	Symbol	Min.	Typ.	Max.	Units
Power Gain	$P_{IN} = 31\text{ dBm}$, 2500 MHz	G_P	10	11	-	dB
Drain Efficiency	$P_{IN} = 31\text{ dBm}$, 2500 MHz	η_D	40	45	-	%
Input Return Loss	$P_{IN} = 31\text{ dBm}$, 2500 MHz	IRL	-	-20	-10	dB

6. Performance in MACOM Production Test Fixture tuned for 2500 MHz.

DC Electrical Specifications: $T_A = 25^\circ\text{C}$

Parameter	Test Conditions	Symbol	Min.	Typ.	Max.	Units
Drain-Source Leakage Current	$V_{GS} = -5\text{ V}$, $V_{DS} = 28\text{ V}$	I_{DLK}	-	0.8	4.8	mA
Gate-Source Leakage Current	$V_{GS} = -5\text{ V}$, $V_{DS} = 0\text{ V}$	I_{GLK}	-4.8	-0.8	-	mA
Gate Threshold Voltage	$V_{DS} = 28\text{ V}$, $I_D = 4.8\text{ mA}$	V_T	-2.5	-2.1	-0.5	V
Gate Quiescent Voltage	$V_{DS} = 28\text{ V}$, $I_D = 130\text{ mA}$	V_{GSQ}	-2.3	-1.9	-0.3	V
On Resistance	$V_{DS} = 2\text{ V}$, $I_D = 48\text{ mA}$	R_{ON}	0.5	1.0	1.5	Ω
Maximum Drain Current	$V_{DS} = 7\text{ V}$ pulsed, pulse width 300 μs	I_{DMAX}	-	2.8	-	A

Thermal Characteristics⁷

Parameter	Test Conditions	Symbol	Min.	Typ.	Max.	Units
Channel-to-Case Thermal Resistance	$V_{DS} = 28\text{ V}$, $P_{Diss} = 16\text{ W}$, $T_C = 85^\circ\text{C}$	Θ_{CH-C}	-	6.7	-	$^\circ\text{C/W}$

7. Channel temperature determined using Raman and simulation techniques. Case temperature measured using thermocouple embedded in heat-sink. Contact local application support team for more details on this measurement.

Absolute Maximum Ratings^{8,9,10}

Parameter	Absolute Maximum
Input Power	35 dBm
Drain Source Voltage, V_{DS}	40 V
Gate Source Voltage, V_{GS}	-8 to +2 V
Gate Current, I_G	9.6 mA
Channel Temperature, T_{CH}	+225 $^\circ\text{C}$
Operating Temperature	-40 $^\circ\text{C}$ to +85 $^\circ\text{C}$
Storage Temperature	-65 $^\circ\text{C}$ to +150 $^\circ\text{C}$

8. Exceeding any one or combination of these limits may cause permanent damage to this device.

9. MACOM does not recommend sustained operation near these survivability limits.

10. Operating at nominal conditions with $T_{CH} \leq 210^\circ\text{C}$ will ensure MTTF > 1×10^6 hours.

Handling Procedures

Please observe the following precautions to avoid damage:

Static Sensitivity

Gallium Nitride Circuits are sensitive to electrostatic discharge (ESD) and can be damaged by static electricity. Proper ESD control techniques should be used when handling these HBM Class 1A devices.

Bias Sequencing

Turning the device ON

1. Set V_{GS} to the pinch-off (V_P), typically -5 V.
2. Turn on V_{DS} to nominal voltage (28 V).
3. Increase V_{GS} until the I_{DS} current is reached.
4. Apply RF power to desired level.

Turning the device OFF

1. Turn the RF power off.
2. Decrease V_{GS} down to V_P .
3. Decrease V_{DS} down to 0 V.
4. Turn off V_{GS} .

Evaluation Board Layout (20 - 2500 MHz)

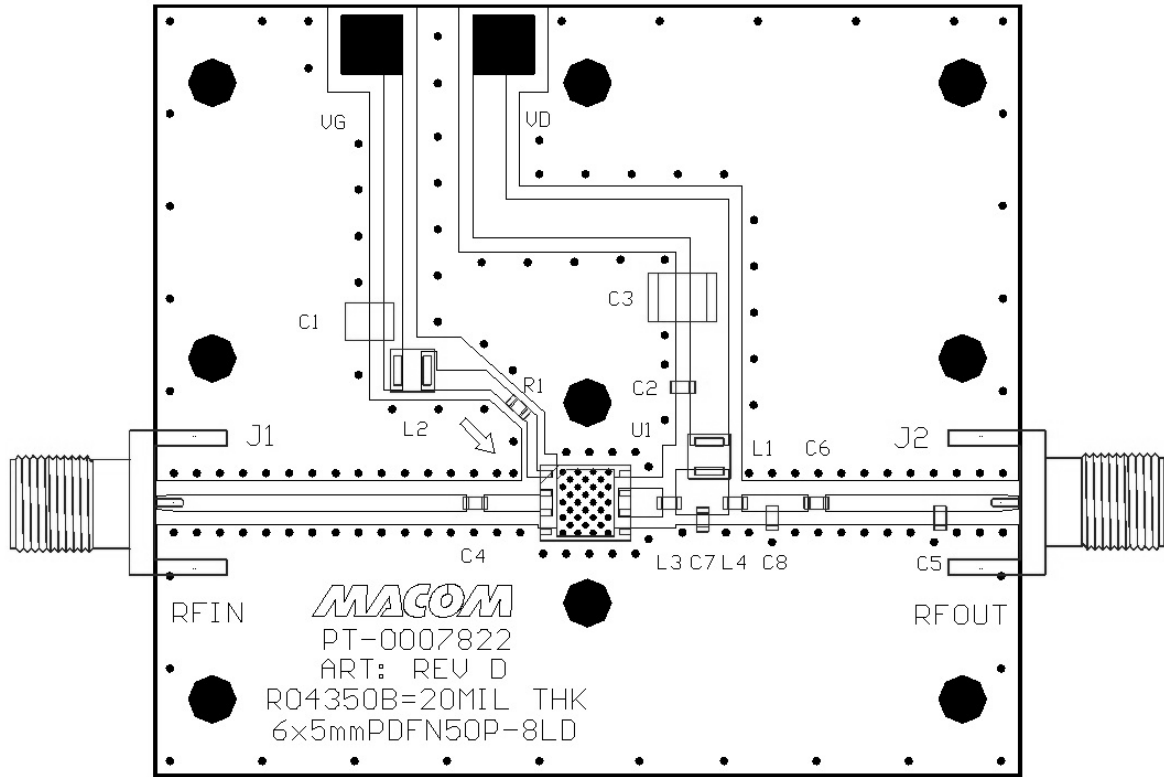

Description

Parts measured on evaluation board (20-mil thick RO4350). The PCB's electrical and thermal ground is provided using a densely plated via hole array (see recommended via pattern).

Matching is provided using a combination of lumped elements and transmission lines as shown in the simplified schematic above. Recommended tuning solution, component placement, transmission lines, and details are shown on the next page.

Recommended Via Pattern (All dimensions in inches)

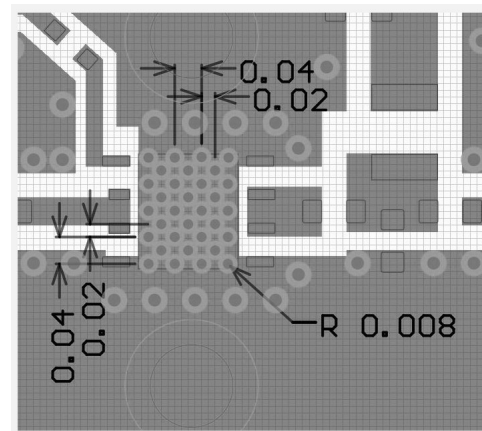

Evaluation Board Schematic (20 - 2500 MHz)

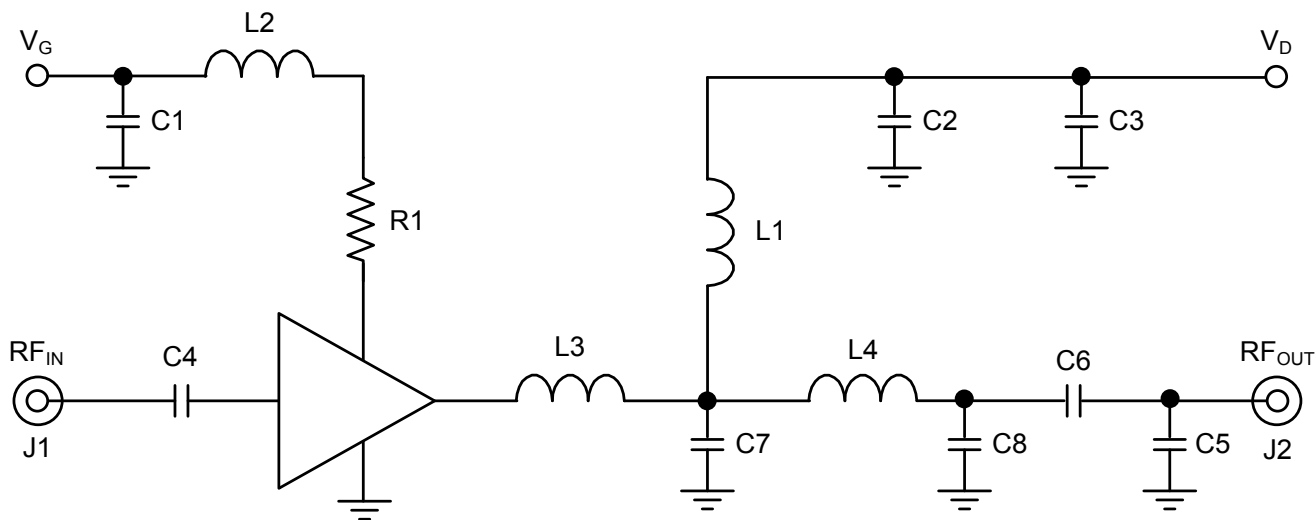

Evaluation Board Components

Reference	Value	Tolerance	Manufacturer	Part Number
C1,C3	1 μ F	10%	TDK	C4532X7T2E105K250KA
C2	1 nF	10%	Murata	GRM188R72A102KA01D
C4, C6	10 nF	10%	Murata	GCM188R72A103KA37D
C5	0.7 pF	± 0.05 pF	PPI	0603N0R7AW251
C7	1.7 pF	± 0.1 pF	PPI	0603N1R7BW251
C8	1.3 pF	± 0.05 pF	PPI	0603N1R3AW251
R1	47 Ω	1%	Panasonic	ERJ-P03F47R0V
L1,L2	0.9 μ H	5%	Coilcraft	1008AF-901XJLC
L3	1 nH	5%	Coilcraft	0603CT-1N0XJLU
L4	1.8 nH	5%	Coilcraft	0603HP-1N8XJLU
PCB	Rogers RO4350, $\epsilon_r=3.66$, 0.020"			
Heat Sink	Copper Heat Sink 2.0" x 2.25" x 0.25"			

GaN on Silicon Power Amplifier 20 - 2500 MHz, 28 V, 10 W

Rev. V2

Typical Performance as Measured in 20 - 2500 MHz Evaluation Board:
CW, $V_{DS} = 28\text{ V}$, $I_{DQ} = 130\text{ mA}$, $T_C = 25^\circ\text{C}$

Small Signal Gain

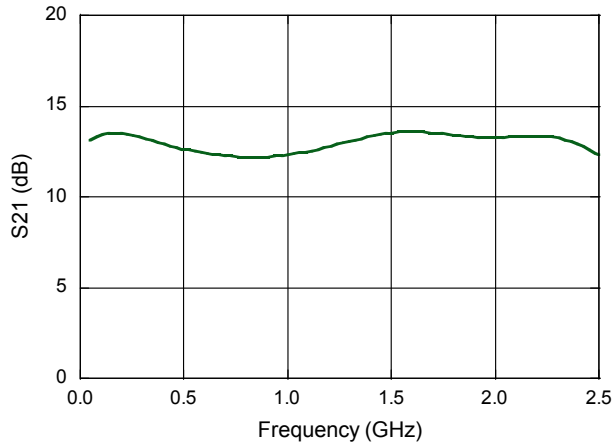

Input Return Loss

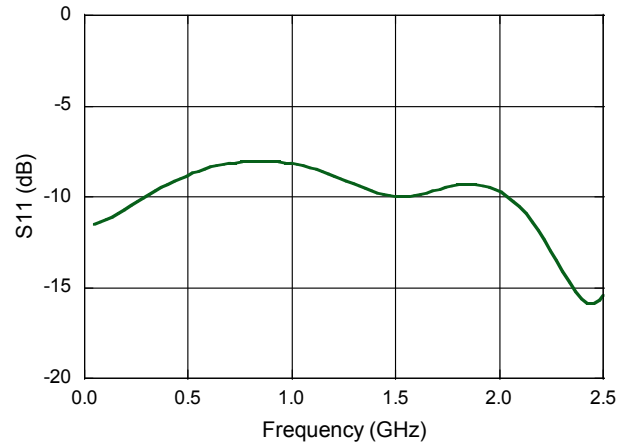

Output Return Loss

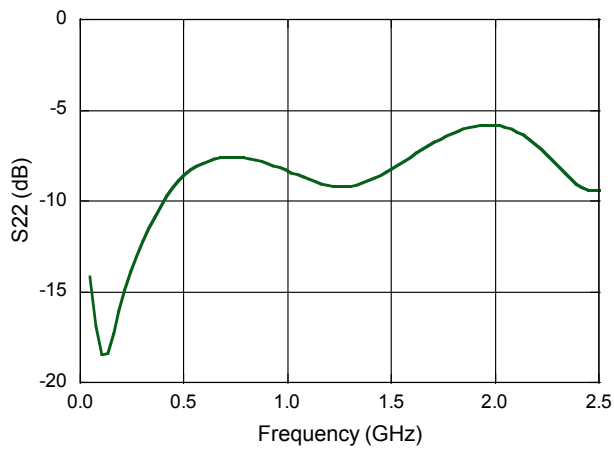

GaN on Silicon Power Amplifier 20 - 2500 MHz, 28 V, 10 W

Rev. V2

Typical Performance as Measured in 20 - 2500 MHz Evaluation Board:
CW, $V_{DS} = 28\text{ V}$, $I_{DQ} = 130\text{ mA}$, $T_C = 25^\circ\text{C}$

Gain vs. Frequency @ $P_{OUT} = 40\text{ dBm}$

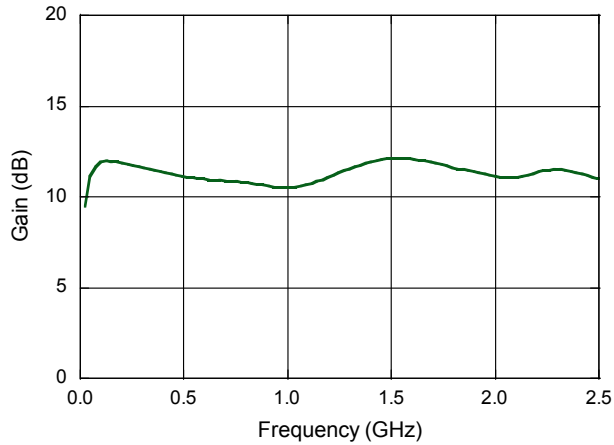

Drain Efficiency vs. Frequency @ $P_{OUT} = 40\text{ dBm}$

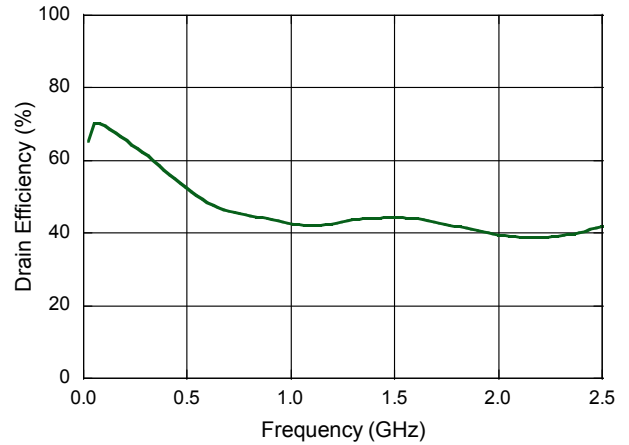

Gain vs. P_{OUT}

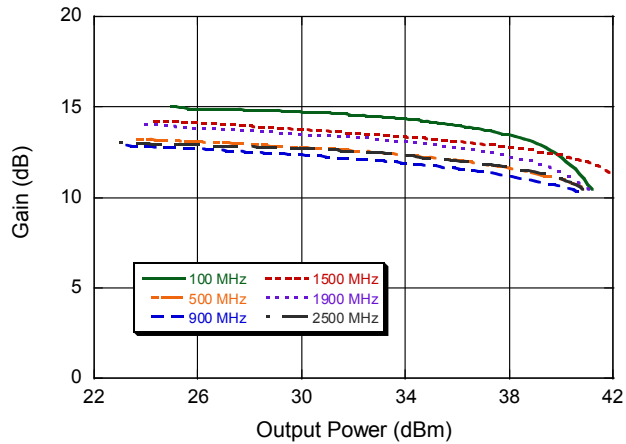

Drain Efficiency vs. P_{OUT}

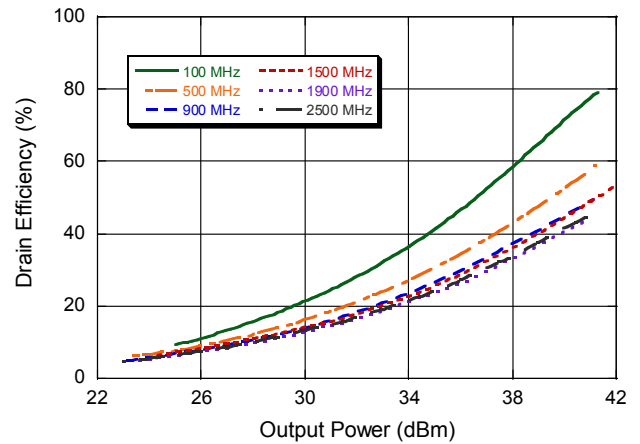

GaN on Silicon Power Amplifier 20 - 2500 MHz, 28 V, 10 W

Rev. V2

Typical Performance as Measured in 20 - 2500 MHz Evaluation Board:
CW, $V_{DS} = 28\text{ V}$, $I_{DQ} = 130\text{ mA}$, $T_C = 25^\circ\text{C}$ (Unless Otherwise Specified)

Performance vs. Temperature at $P_{IN} = 30\text{ dBm}$

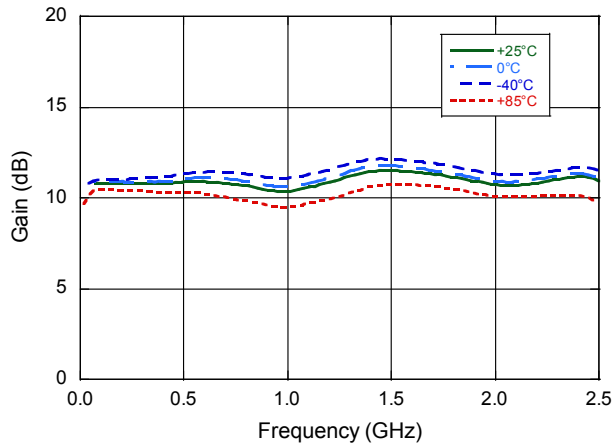

Performance vs. Temperature at $P_{IN} = 30\text{ dBm}$

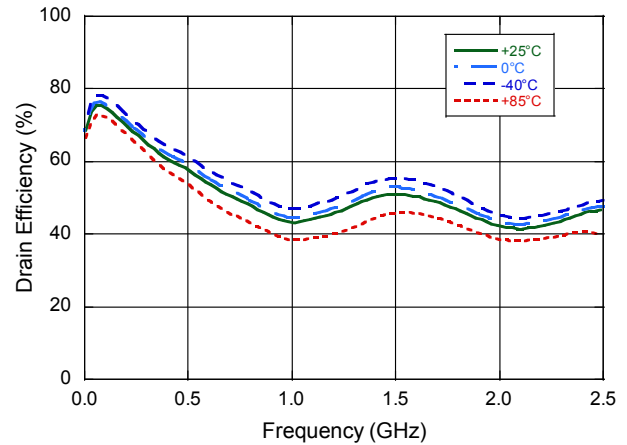

Performance vs. Drain Voltage at $P_{IN} = 30\text{ dBm}$

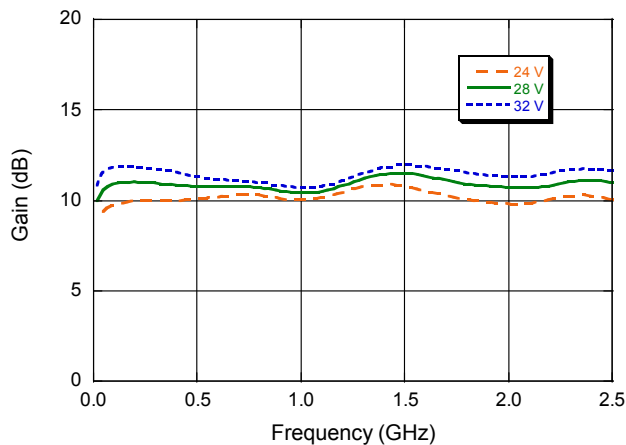

Performance vs. Drain Voltage at $P_{IN} = 30\text{ dBm}$

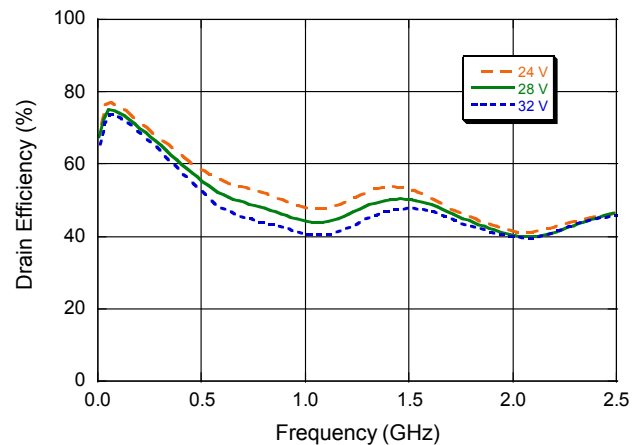

Performance vs. Bias Current at $P_{IN} = 30\text{ dBm}$

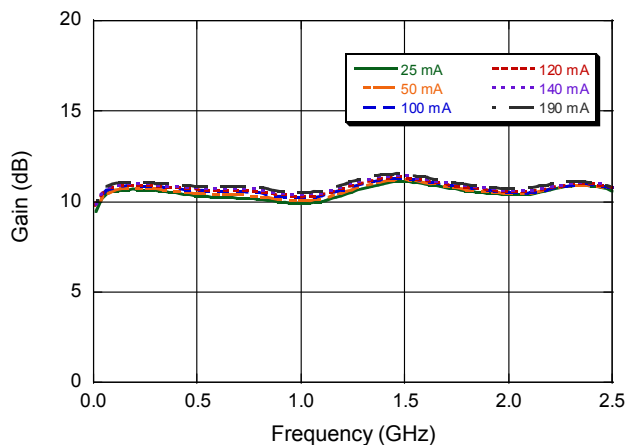

Performance vs. Bias Current at $P_{IN} = 30\text{ dBm}$

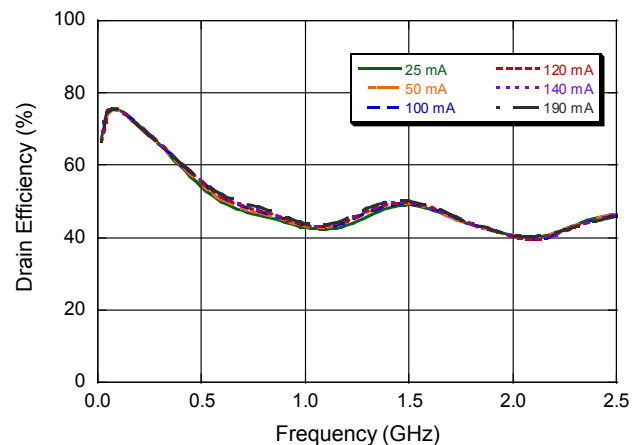

Lead-Free 6 x 5 mm 8-Lead PDFN[†]

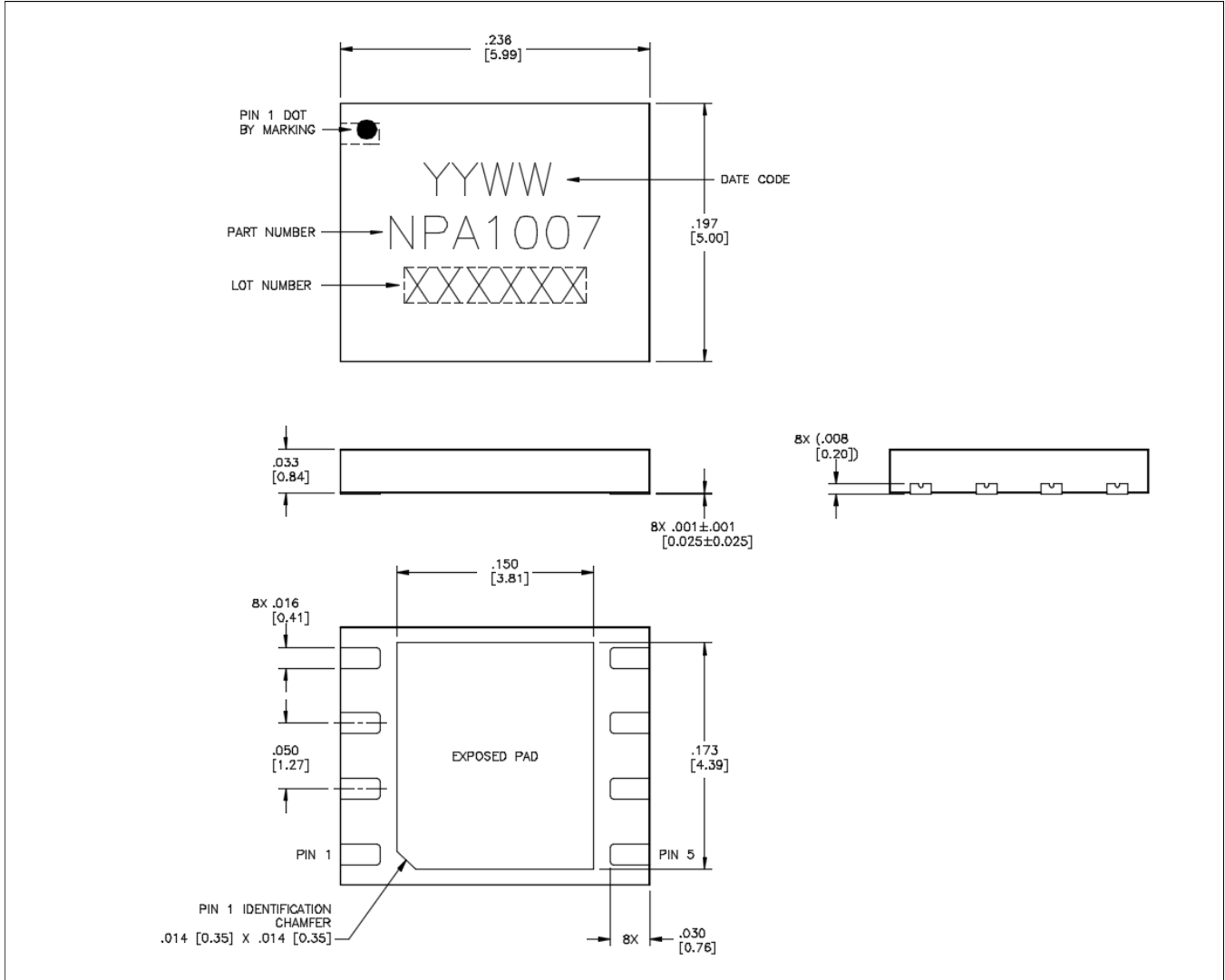

[†] Meets JEDEC moisture sensitivity level 3 requirements.
 Plating is Ni/Pd/Au.
 Refer to application note S2083 for lead-free solder reflow recommendations.

MACOM Technology Solutions Inc. All rights reserved.

Information in this document is provided in connection with MACOM Technology Solutions Inc ("MACOM") products. These materials are provided by MACOM as a service to its customers and may be used for informational purposes only. Except as provided in MACOM's Terms and Conditions of Sale for such products or in any separate agreement related to this document, MACOM assumes no liability whatsoever. MACOM assumes no responsibility for errors or omissions in these materials. MACOM may make changes to specifications and product descriptions at any time, without notice. MACOM makes no commitment to update the information and shall have no responsibility whatsoever for conflicts or incompatibilities arising from future changes to its specifications and product descriptions. No license, express or implied, by estoppel or otherwise, to any intellectual property rights is granted by this document.

THESE MATERIALS ARE PROVIDED "AS IS" WITHOUT WARRANTY OF ANY KIND, EITHER EXPRESS OR IMPLIED, RELATING TO SALE AND/OR USE OF MACOM PRODUCTS INCLUDING LIABILITY OR WARRANTIES RELATING TO FITNESS FOR A PARTICULAR PURPOSE, CONSEQUENTIAL OR INCIDENTAL DAMAGES, MERCHANTABILITY, OR INFRINGEMENT OF ANY PATENT, COPYRIGHT OR OTHER INTELLECTUAL PROPERTY RIGHT. MACOM FURTHER DOES NOT WARRANT THE ACCURACY OR COMPLETENESS OF THE INFORMATION, TEXT, GRAPHICS OR OTHER ITEMS CONTAINED WITHIN THESE MATERIALS. MACOM SHALL NOT BE LIABLE FOR ANY SPECIAL, INDIRECT, INCIDENTAL, OR CONSEQUENTIAL DAMAGES, INCLUDING WITHOUT LIMITATION, LOST REVENUES OR LOST PROFITS, WHICH MAY RESULT FROM THE USE OF THESE MATERIALS.

MACOM products are not intended for use in medical, lifesaving or life sustaining applications. MACOM customers using or selling MACOM products for use in such applications do so at their own risk and agree to fully indemnify MACOM for any damages resulting from such improper use or sale.

X-ON Electronics

Largest Supplier of Electrical and Electronic Components

Click to view similar products for [RF Amplifier](#) category:

Click to view products by [MACOM](#) manufacturer:

Other Similar products are found below :

[A82-1](#) [BGA622H6820XTSA1](#) [BGA 728L7 E6327](#) [BGB719N7ESDE6327XTMA1](#) [HMC397-SX](#) [HMC405](#) [HMC561-SX](#) [HMC8120-SX](#)
[HMC8121-SX](#) [HMC-ALH382-SX](#) [HMC-ALH476-SX](#) [SE2433T-R](#) [SMA3101-TL-E](#) [SMA39](#) [A66-1](#) [A66-3](#) [A67-1](#) [LX5535LQ](#) [LX5540LL](#)
[MAAM02350](#) [HMC3653LP3BETR](#) [HMC549MS8GETR](#) [HMC-ALH435-SX](#) [SMA101](#) [SMA32](#) [SMA411](#) [SMA531](#) [SST12LP17E-XX8E](#)
[SST12LP19E-QX6E](#) [WPM0510A](#) [HMC5929LS6TR](#) [HMC5879LS7TR](#) [HMC1126](#) [HMC1087F10](#) [HMC1086](#) [HMC1016](#) [SMA1212](#)
[MAX2689EWS+T](#) [MAAMSS0041TR](#) [MAAM37000-A1G](#) [LTC6430AIUF-15#PBF](#) [CHA5115-QDG](#) [SMA70-2](#) [SMA4011](#) [A231](#) [HMC-](#)
[AUH232](#) [LX5511LQ](#) [LX5511LQ-TR](#) [HMC7441-SX](#) [HMC-ALH310](#)