

## Features

- Excellent Transmit LO/Output Buffer Stage
- 17 dB Small Signal Gain
- 20 dBm Psat
- 32 dBm Output IP3
- 4.5 dB Noise Figure
- Variable Gain with Adjustable Bias
- 100% RF, DC and Output Power Testing
- Lead-Free 3 mm 16-Lead QFN Package
- RoHS\* Compliant

## Description

The XB1008-QT is a two stage 10 - 21 GHz GaAs MMIC buffer amplifier that has a small signal gain of 17 dB with a 18 dBm P1dB output compression point. The device also provides variable gain regulation with adjustable bias.

The device is ideally suited as an LO or RF buffer stage with broadband performance at a very low cost. The device comes in an RoHS compliant 3 mm QFN surface mount package offering excellent RF and thermal properties. This device is specifically designed for use in PtP radio applications and is well suited for other telecom applications such as SATCOM and VSAT.

## Ordering Information<sup>1</sup>

Part Number	Package
XB1008-QT-0G0T	tape and reel
XB1008-QT-EV1	evaluation module

1. Reference Application Note M513 for reel size information.

## Functional Block Diagram

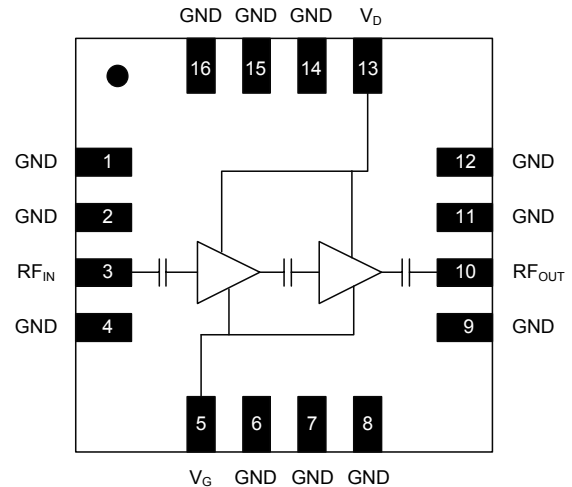

## Pin Configuration

Pin No.	Function
1-2, 4, 6-9, 11, 12, 14-16	Ground
3	RF Input
5	Gate Bias
10	RF Output
13	Drain Bias
Paddle <sup>2</sup>	Ground

2. The exposed pad centered on the package bottom must be connected to RF, DC and thermal ground.

\* Restrictions on Hazardous Substances, European Union Directive 2011/65/EU.

**Electrical Specifications: 10 - 21 GHz, T<sub>A</sub> = +25°C**

Parameter	Units	Min.	Typ.	Max.
Input Return Loss (S11)	dB	—	12	—
Output Return Loss (S22)	dB	—	12	—
Small Signal Gain (S21)	dB	—	17	—
Gain Flatness ( $\Delta S_{21}$ )	dB	—	+/-2	—
Reverse isolation (S12)	dB	—	65	—
Noise Figure	dB	—	4.5	—
Output Power for 1dB Compression Point (P1dB)	dBm	—	18	—
Saturated Output Power (P <sub>SAT</sub> )	dBm	—	20	—
Output Third Order Intercept	dBm	—	32	—
Drain Bias Voltage (V <sub>D</sub> )	VDC	—	4	4
Gate Bias Voltage (V <sub>G</sub> )	VDC	-1.0	-0.23	-0.1
Supply Current (I <sub>D</sub> ) (V <sub>D</sub> = +4.0 V, V <sub>G2</sub> = -0.5 V Typical)	mA	—	100	130

### Absolute Maximum Ratings<sup>3</sup>

Parameter	Absolute Maximum
Supply Voltage	4.3 VDC
Supply Current	180 mA
Gate Bias Voltage	0 V
Input Power	20 dBm
Storage Temperature	-65°C to +165°C
Operating Temperature	-55°C to +85°C
Channel Temperature	150°C

3. Channel temperature directly affects a device's MTTF. Channel temperature should be kept as low as possible to maximize lifetime.

### Handling Procedures

Please observe the following precautions to avoid damage:

### Static Sensitivity

These electronic devices are sensitive to electrostatic discharge (ESD) and can be damaged by static electricity. Proper ESD control techniques should be used when handling these HBM Class 1A devices, MM Class A devices.

## Typical Performance Curves

**Small Signal Gain,  $V_D = 4\text{ V}$ ,  $100\text{ mA}$**

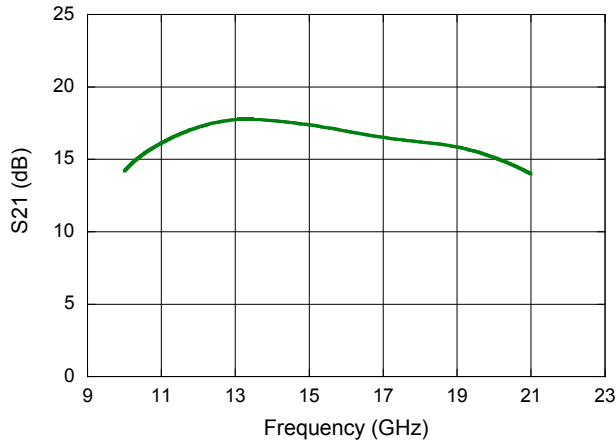

**OIP3,  $V_D = 4\text{ V}$ ,  $90\text{ mA}$ ,  $P_{IN} = 15\text{ dBm}$**

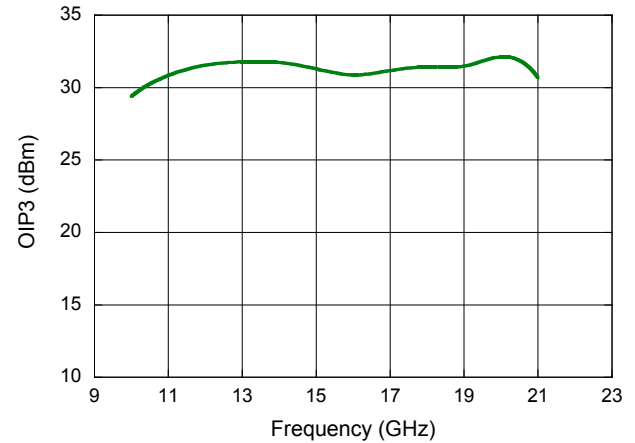

**Input Return Loss,  $V_D = 4\text{ V}$ ,  $100\text{ mA}$**

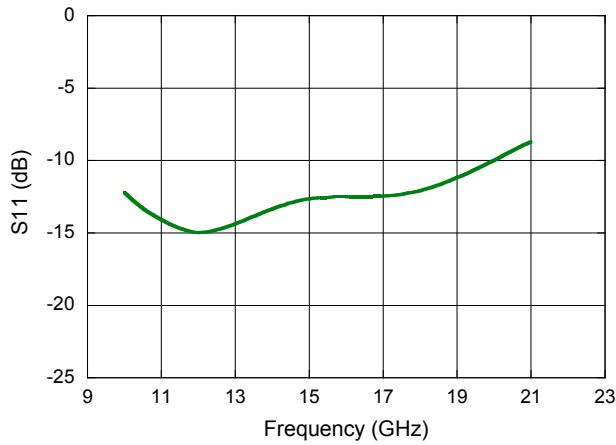

**Output Return Loss,  $V_D = 4\text{ V}$ ,  $100\text{ mA}$**

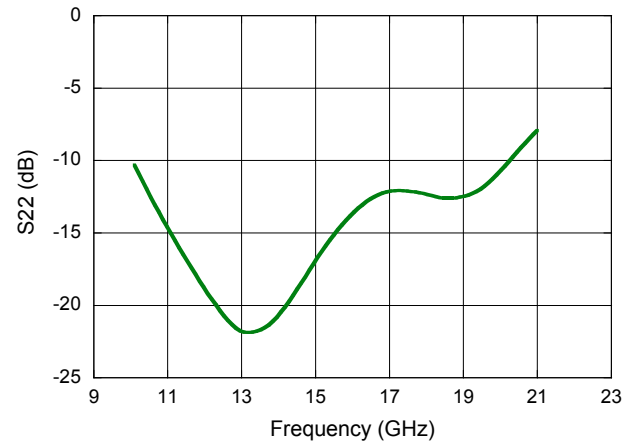

**OIP3,  $V_D = 4\text{ V}$ ,  $20 - 100\text{ mA}$ ,  $P_{IN} = -15\text{ dBm}$**

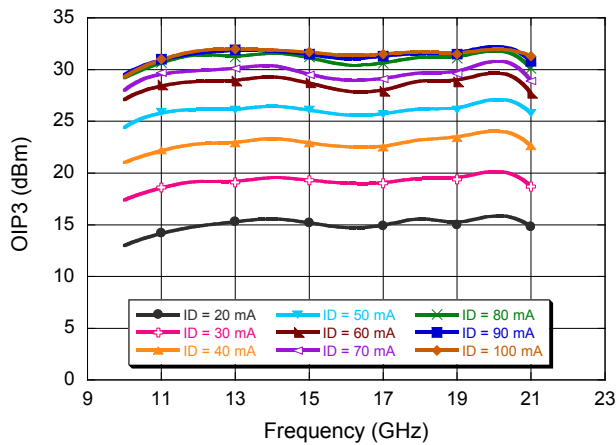

## Typical Performance Curves (cont.)

**Output Power vs. Input Power,  $V_D = 4 V$ , 100 mA**

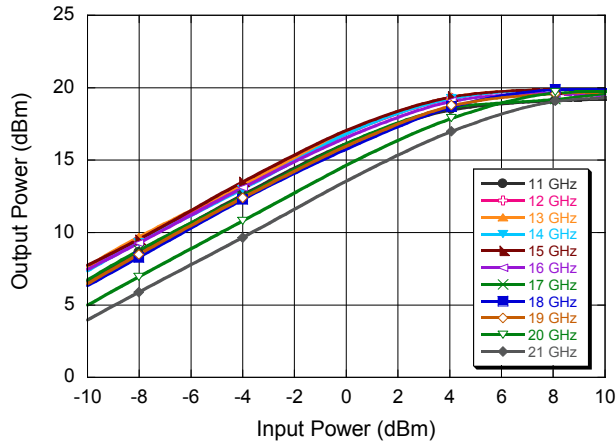

**Output Power vs. Frequency,  $V_D = 4 V$ , 100 mA**

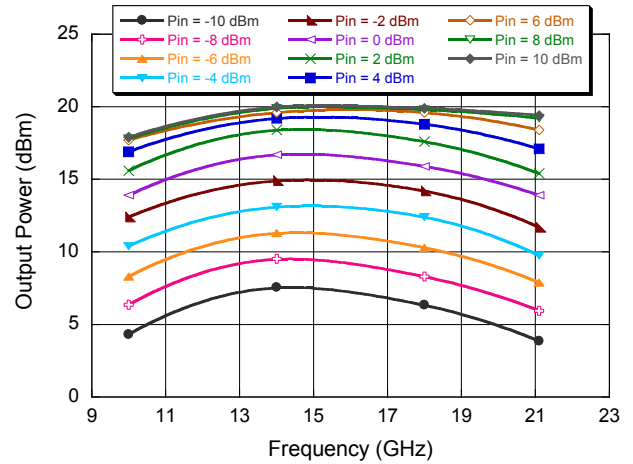

## MTTF

These numbers were calculated based on accelerated life test information and thermal model analysis received from the fabricating foundry.

**MTTF Hours vs. Package Base Temperature,  $V_{DD} = 4 V$**

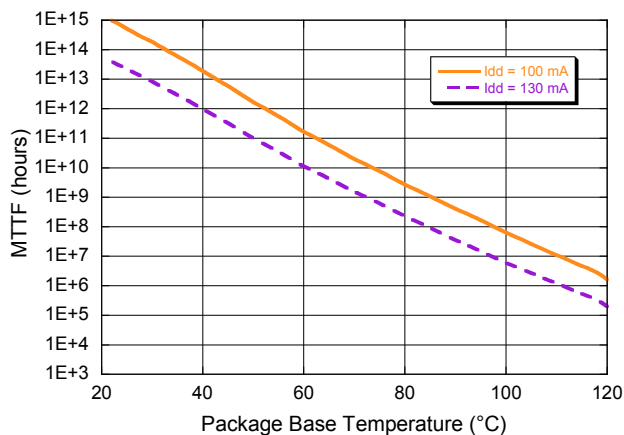

**$T_{ch} (max.)$  vs. Package Base Temperature,  $V_{DD} = 4 V$**

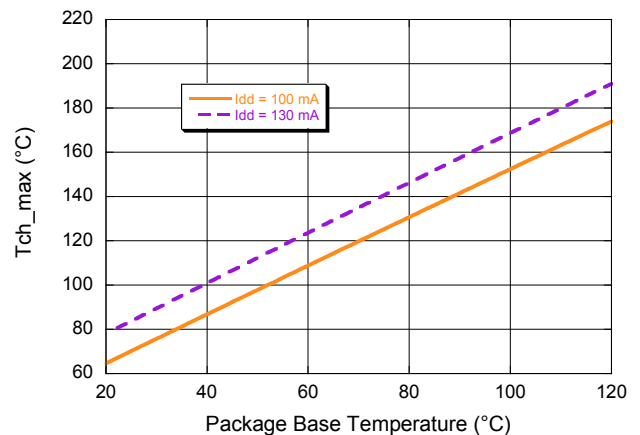

## Buffer Amplifier 10 - 21 GHz

Rev. V2

**App Note [1] Biasing** - The device provides variable gain with adjustable bias regulation. For optimum linearity performance, it is recommended to bias this device at  $V_D = 4$  V with  $I_D = 90$  mA. It is also recommended to use active biasing to control the drain currents because this gives the most reproducible results over temperature or RF level variations. Depending on the supply voltage available and the power dissipation constraints, the bias circuit may be a single transistor or a low power operational amplifier, with a low value resistor in series with the drain supply used to sense the current. The gate of the pHEMT is controlled to maintain correct drain current and thus drain voltage. The typical gate voltage needed to do this is  $-0.5$  V. Typically the gate is protected with silicon diodes to limit the applied voltage. Also, make sure to sequence the applied voltage to ensure negative gate bias is available before applying the positive drain supply.

### Lead-Free Package Dimensions/Layout†

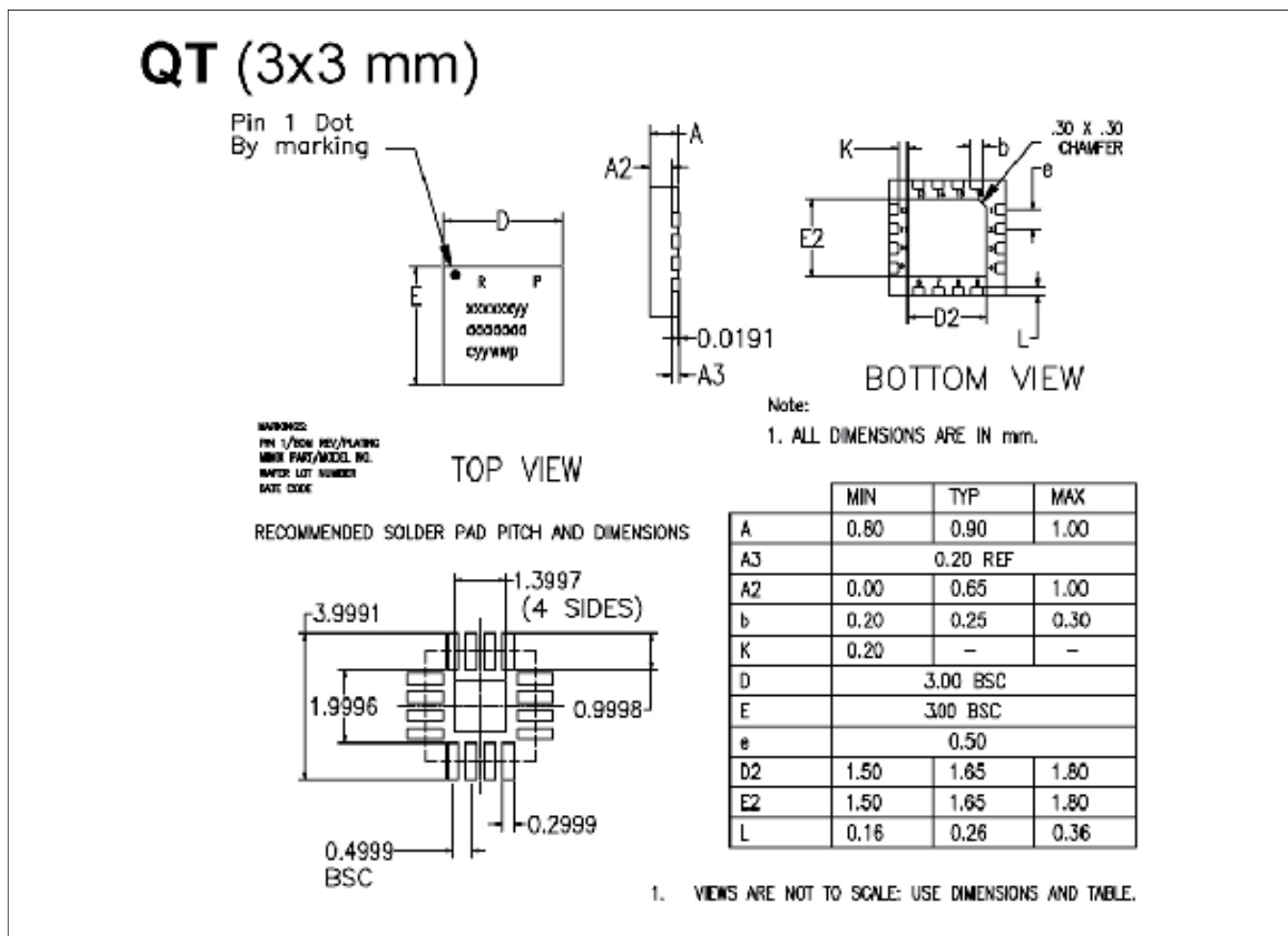

† Reference Application Note S2083 for lead-free solder reflow recommendations.  
Meets JEDEC moisture sensitivity level 1 requirements.

M/A-COM Technology Solutions Inc. All rights reserved.

Information in this document is provided in connection with M/A-COM Technology Solutions Inc ("MACOM") products. These materials are provided by MACOM as a service to its customers and may be used for informational purposes only. Except as provided in MACOM's Terms and Conditions of Sale for such products or in any separate agreement related to this document, MACOM assumes no liability whatsoever. MACOM assumes no responsibility for errors or omissions in these materials. MACOM may make changes to specifications and product descriptions at any time, without notice. MACOM makes no commitment to update the information and shall have no responsibility whatsoever for conflicts or incompatibilities arising from future changes to its specifications and product descriptions. No license, express or implied, by estoppel or otherwise, to any intellectual property rights is granted by this document.

THESE MATERIALS ARE PROVIDED "AS IS" WITHOUT WARRANTY OF ANY KIND, EITHER EXPRESS OR IMPLIED, RELATING TO SALE AND/OR USE OF MACOM PRODUCTS INCLUDING LIABILITY OR WARRANTIES RELATING TO FITNESS FOR A PARTICULAR PURPOSE, CONSEQUENTIAL OR INCIDENTAL DAMAGES, MERCHANTABILITY, OR INFRINGEMENT OF ANY PATENT, COPYRIGHT OR OTHER INTELLECTUAL PROPERTY RIGHT. MACOM FURTHER DOES NOT WARRANT THE ACCURACY OR COMPLETENESS OF THE INFORMATION, TEXT, GRAPHICS OR OTHER ITEMS CONTAINED WITHIN THESE MATERIALS. MACOM SHALL NOT BE LIABLE FOR ANY SPECIAL, INDIRECT, INCIDENTAL, OR CONSEQUENTIAL DAMAGES, INCLUDING WITHOUT LIMITATION, LOST REVENUES OR LOST PROFITS, WHICH MAY RESULT FROM THE USE OF THESE MATERIALS.

MACOM products are not intended for use in medical, lifesaving or life sustaining applications. MACOM customers using or selling MACOM products for use in such applications do so at their own risk and agree to fully indemnify MACOM for any damages resulting from such improper use or sale.

## X-ON Electronics

Largest Supplier of Electrical and Electronic Components

*Click to view similar products for [RF Amplifier](#) category:*

*Click to view products by [MACOM](#) manufacturer:*

Other Similar products are found below :

[A82-1](#) [BGA622H6820XTSA1](#) [BGA 728L7 E6327](#) [BGB719N7ESDE6327XTMA1](#) [HMC397-SX](#) [HMC405](#) [HMC561-SX](#) [HMC8120-SX](#)  
[HMC8121-SX](#) [HMC-ALH382-SX](#) [HMC-ALH476-SX](#) [SE2433T-R](#) [SMA3101-TL-E](#) [SMA39](#) [A66-1](#) [A66-3](#) [A67-1](#) [LX5535LQ](#) [LX5540LL](#)  
[MAAM02350](#) [HMC3653LP3BETR](#) [HMC549MS8GETR](#) [HMC-ALH435-SX](#) [SMA101](#) [SMA32](#) [SMA411](#) [SMA531](#) [SST12LP17E-XX8E](#)  
[SST12LP19E-QX6E](#) [WPM0510A](#) [HMC5929LS6TR](#) [HMC5879LS7TR](#) [HMC1126](#) [HMC1087F10](#) [HMC1086](#) [HMC1016](#) [SMA1212](#)  
[MAX2689EWS+T](#) [MAAMSS0041TR](#) [MAAM37000-A1G](#) [LTC6430AIUF-15#PBF](#) [CHA5115-QDG](#) [SMA70-2](#) [SMA4011](#) [A231](#) [HMC-](#)  
[AUH232](#) [LX5511LQ](#) [LX5511LQ-TR](#) [HMC7441-SX](#) [HMC-ALH310](#)