

### Features

- 15.5 dB Small Signal Gain
- 47 dBm Third Order Intercept Point (OIP3)
- 2 W P1dB
- Integrated Power Detector
- Lead-Free 6 mm 24-lead QFN Package
- RoHS\* Compliant and 260°C Reflow Compatible

### Description

The XP1050-QJ is a packaged linear power amplifier that operates from 7.1-8.5 GHz. The device provides 15.5 dB gain and 47 dBm Output Third Order Intercept Point (OIP3). The packaged amplifier comes in an industry standard, fully molded 6 mm QFN package and is comprised of a two stage power amplifier with an integrated, temperature compensated on-chip power detector. The device includes on-chip ESD protection structures and DC by-pass capacitors to ease the implementation and volume assembly of the packaged part.

The device is specifically designed for use in 7 and 8 GHz Point-to-Point radio applications.

External DC blocks are required. See the reliability note on page 3 for more information.

### Ordering Information<sup>1,2</sup>

Part Number	Package
XP1050-QJ-0G00	bulk quantity
XP1050-QJ-0G0T	tape and reel
XP1050-QJ-EV1	evaluation module

1. Reference Application Note M513 for reel size information.
2. All sample boards include 5 loose parts.

### Functional Schematic

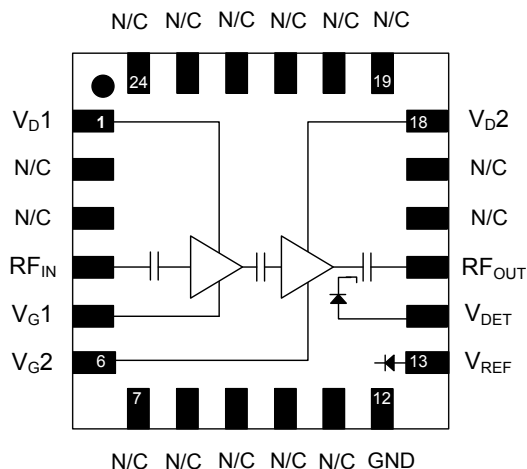

### Pin Configuration<sup>3</sup>

Pin No.	Pin Name	Function
1	V <sub>D1</sub>	Drain 1 Bias
2-3	N/C	No Connection
4	RF <sub>IN</sub>	RF Input
5	V <sub>G1</sub>	Gate 1 Bias
6	V <sub>G2</sub>	Gate 2 Bias
7-11	N/C	No Connection
12	GND	Ground
13	V <sub>REF</sub>	Power Det. Ref.
14	V <sub>DET</sub>	Power Detector
15	RF <sub>OUT</sub>	RF Output
16-17	N/C	No Connection
18	V <sub>D2</sub>	Drain 2 Bias
19-24	N/C	No Connection
25 <sup>4</sup>	Pad	Ground

3. It is recommended to connect unused pins to ground.
4. The exposed pad centered on the package bottom must be connected to RF and DC ground.

\* Restrictions on Hazardous Substances, European Union Directive 2002/95/EC.

## 2.5 W Power Amplifier 7.1 - 8.5 GHz

Rev. V1

**Electrical Specifications: Freq: 7.1 - 8.5 GHz,  $V_{DD} = 7\text{ V}$ ,  $I_{DQ}^5 = 1350\text{ mA}$ ,  $T_A = +25^\circ\text{C}$**

Parameter	Units	Min.	Typ.	Max.
Gain @ 6 dBm $P_{IN}$	dB	13.5	15.5	18.5
Input Return Loss	dB	—	10	—
Output Return Loss	dB	—	8	—
P1dB	dBm	—	33	—
$P_{sat}^6$	dBm	—	34	—
Output IP3 @ 6 dBm $P_{IN}$	dBm	43.5	47	—
Delta $V_{DET}$ ( $V_{DET} - V_{REF}$ ) @ 6 dBm $P_{IN}$ , 8.5 GHz	V	—	-0.88	—
Detector Bias Voltage	VDC	—	5	—
Gate Bias Voltage ( $V_{GG1,2}$ )	VDC	—	-0.7	—

5. Adjust  $V_{GG1}$  and  $V_{GG2}$  between  $-1.4$  and  $-0.4\text{ V}$  to achieve specified  $I_{DQ}$ .  $V_{GG1}$  and  $V_{GG2}$  should be the same voltage.  
 6. For reference only. Large signal operation is only recommended under pulsed conditions. Keep output power below P1dB for C.W. operation.

### Maximum Operating Ratings<sup>7,8,9</sup>

Parameter	Absolute Maximum
Input Power	+24 dBm
Drain Supply Voltage	+8 Volts
Junction Temperature <sup>10</sup>	+160 °C
Operating Temperature	-40°C to +85°C
Storage Temperature	-65°C to +150°C

7. Exceeding any one or combination of these limits may cause permanent damage to this device.  
 8. M/A-COM Technology Solutions does not recommend sustained operation near these survivability limits.  
 9. Operating at nominal conditions with  $T_J \leq 160^\circ\text{C}$  will ensure  $MTTF > 1 \times 10^6$  hours.  
 10. Junction Temperature ( $T_J$ ) =  $T_C + \Theta_{JC} * ((V * I) - (P_{OUT} - P_{IN}))$   
 Typical thermal resistance ( $\Theta_{JC}$ ) =  $6.8^\circ\text{C/W}$   
 a) For  $T_C = 25^\circ\text{C}$ ,  
 $T_J = 88^\circ\text{C}$  @ 7 V, 1350 mA,  $P_{OUT} = 21.5\text{ dBm}$ ,  $P_{IN} = 6\text{ dBm}$   
 b) For  $T_C = 85^\circ\text{C}$ ,  
 $T_J = 149^\circ\text{C}$  @ 7 V, 1350 mA,  $P_{OUT} = 20\text{ dBm}$ ,  $P_{IN} = 6\text{ dBm}$

### Absolute Maximum Ratings<sup>11,12</sup>

Parameter	Absolute Max.
Supply Gate Voltage	-2.5 V
Supply Current ( $I_{D1}$ )	600 mA
Supply Current ( $I_{D2}$ )	1200 mA
Detector Pin	6 V
Detector Ref Pin	6 V
Continuous Power Dissipation @ 85°C	11.2 W
Junction Temperature	175°C

11. Channel temperature directly affects a device's MTTF. Channel temperature should be kept as low as possible to maximize lifetime.  
 12. For saturated performance it recommended that the sum of  $(2 * V_{DD} + \text{abs}(V_{GG})) < 17$

### Handling Procedures

Please observe the following precautions to avoid damage:

### Static Sensitivity

Gallium Arsenide Integrated Circuits are sensitive to electrostatic discharge (ESD) and can be damaged by static electricity. Proper ESD control techniques should be used when handling these class 1A devices.

## Important Reliability Information:

The input and output capacitors on the die may be damaged through handling and assembly processes. External DC blocks are recommended on the RF input and output lines on the PC board. If the output capacitor shorts due to ESD damage, the part will continue to function with slightly degraded performance. IP3 may decrease by approximately 1.5 dB. If the input capacitor shorts due to ESD damage, the part will continue to function with a slight shift in input return loss. Once shorted, the capacitor should remain shorted for the standard product lifetime. The external DC blocks are needed to maintain the bias point on the part.

Even though the ESD rating using the Human Body Model is Class 1A, it is recommended to treat this part as a Class 0 part. The rate of shorted capacitors due to ESD damage can be in the range of 10%. Shorted capacitors on this part are not subject to the warranty because the part continues to operate reliably with only slightly reduced performance.

## Recommended Layout

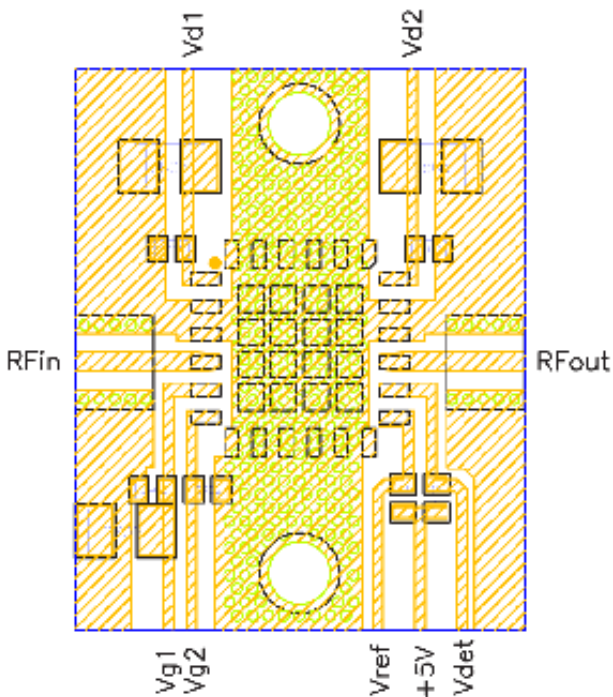

METAL 1  
METAL 2  
SOLDERMASK TOP – POSITIVE VIEW  
VIAS

MATERIAL: RO4350B, 10 mil.  
CAPACITORS: 1 $\mu$ F (0805), 1000 pF (0402)

## 2.5 W Power Amplifier 7.1 - 8.5 GHz

Rev. V1

**App Note [1] Biasing** - As shown in the Pin Designations table, the device is operated by biasing  $V_{d1,2}$  at 7.0V. The nominal drain currents are  $I_{d1}=450$  mA and  $I_{d2}=900$  mA. This ratio of 1:2 between the first and second stage drain currents should be maintained for best linearity. The typical gate voltages needed are -0.9V. The negative gate voltage must be applied prior to applying the positive drain voltage.

The XP1050-QJ is recommended for linear applications only. Active bias is recommended to keep the currents known and constant, and to maintain the best performance over temperature. Depending on the supply voltage available and the power dissipation constraints, the bias circuit may be a single transistor or a low-power operational amplifier, with a low value resistor in series with the drain supply used to sense the current.

**App Note [2] PWB Layout Considerations** - It is recommended to provide 1000 pF decoupling capacitors as close as possible to the pins of the device, with additional larger decoupling capacitors further away. For example, in the Recommended Layout, there are 1000 pF 0402 capacitors placed very near the device pins, and 1uF 0805 capacitors placed further away (the gate line shown without a 1uF capacitor (pin 6) would have this capacitor further away on the other side of the screw).

Thermal management of the device is essential. It is recommended that measures such as copper-filled vias under the package, and post/screws for top to bottom heat transfer are used (see Recommended Layout shown below). Adequate heat-sinking under the PWB is necessary in maintaining the package base at a safe operating temperature.

**App Note [3] Power Detector** - As shown in the schematic at right, the power detector is implemented by providing +5V bias and measuring the difference in output voltage with standard op-amp in a differential mode configuration.

### Application Schematic

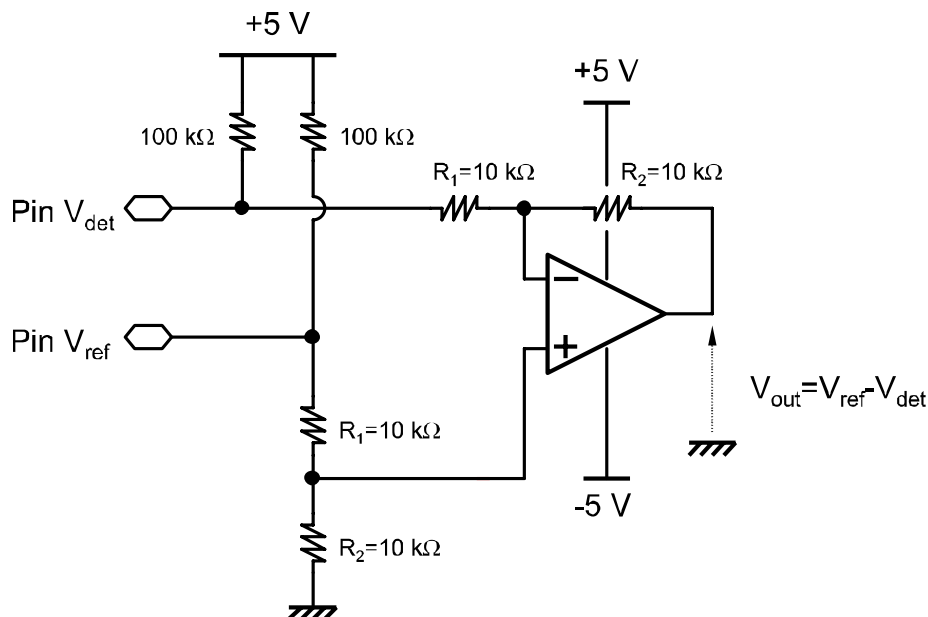

## 2.5 W Power Amplifier 7.1 - 8.5 GHz

Rev. V1

Typical Performance Curves:  $V_{DD} = 7\text{ V}$ ,  $I_{DQ} = 1350\text{ mA}$

Gain vs. Frequency, +25°C

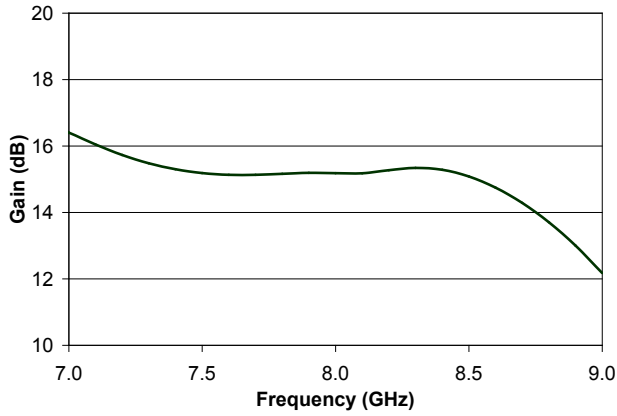

Input Return Loss vs. Frequency, +25°C

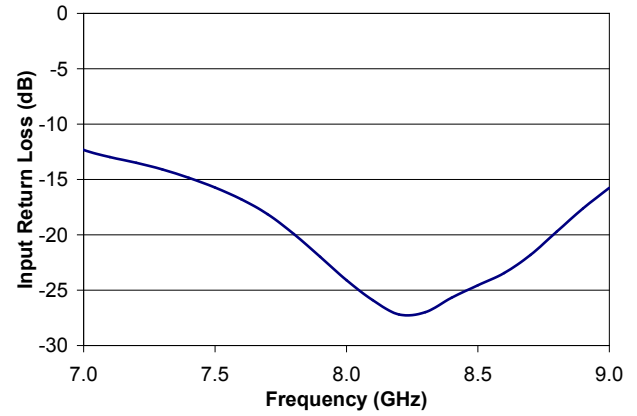

Output Return Loss vs. Frequency, +25°C

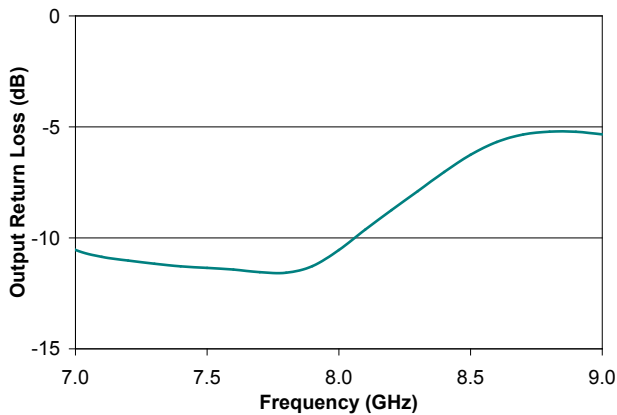

Gain vs. Output Power, +25°C

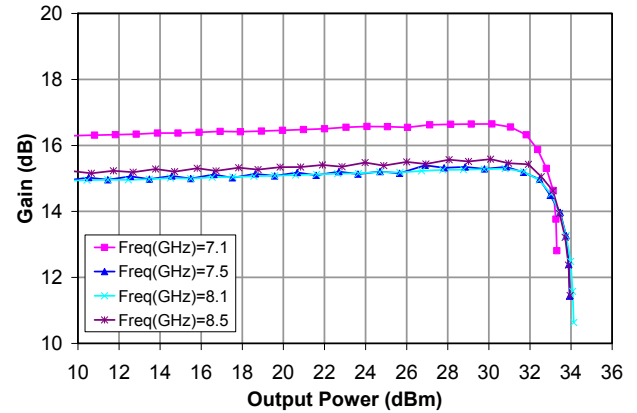

Gain vs. Output Power, -40°C

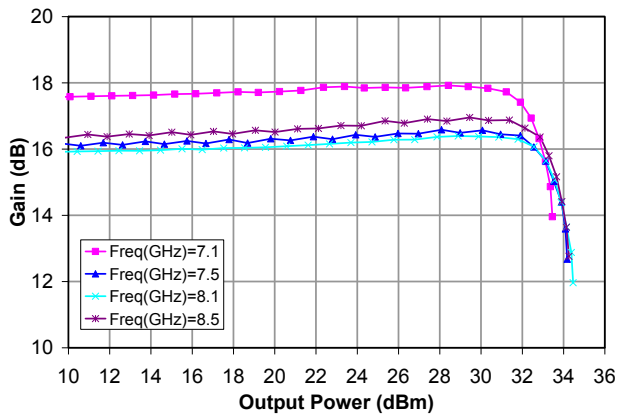

Gain vs. Output Power, +85°C

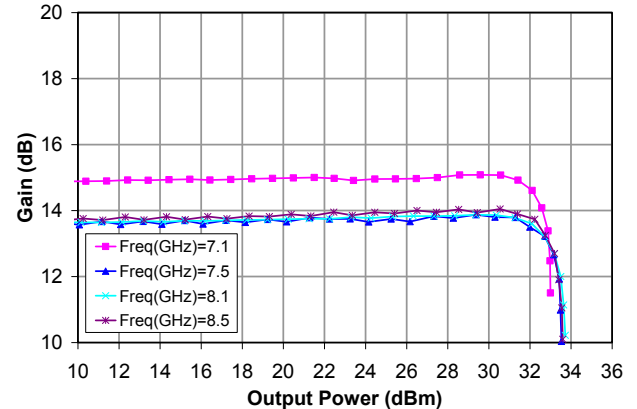

## 2.5 W Power Amplifier 7.1 - 8.5 GHz

Rev. V1

Typical Performance Curves:  $V_{DD} = 7\text{ V}$ ,  $I_{DQ} = 1350\text{ mA}$

Output IP3 vs. Output Power, +25°C

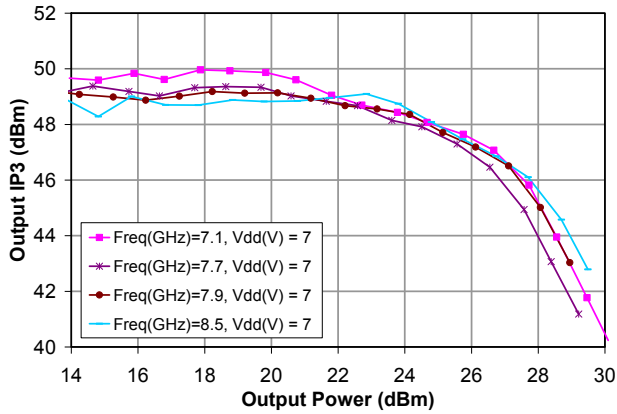

Output IP3 vs. Output Power, -40°C

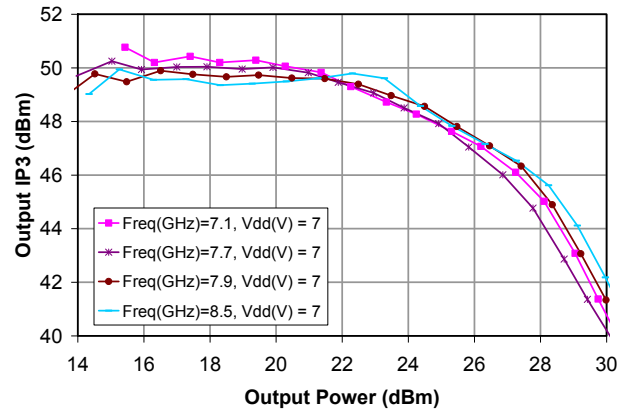

Output IP3 vs. Output Power, +85°C

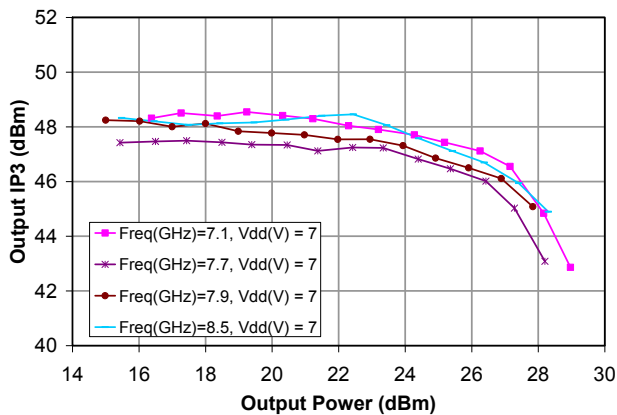

Detector Voltage ( $V_{REF} - V_{DET}$ ) vs. Output Power, +25°C

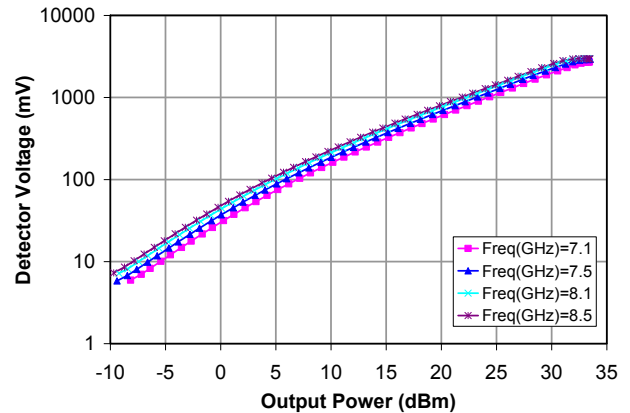

Detector Voltage ( $V_{REF} - V_{DET}$ ) vs. Output Power, -40°C

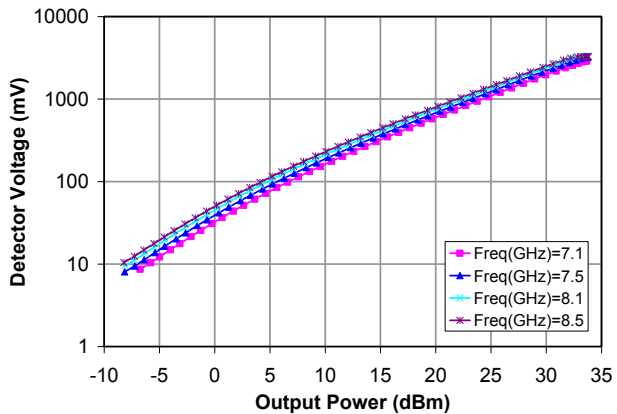

Detector Voltage ( $V_{REF} - V_{DET}$ ) vs. Output Power, +85°C

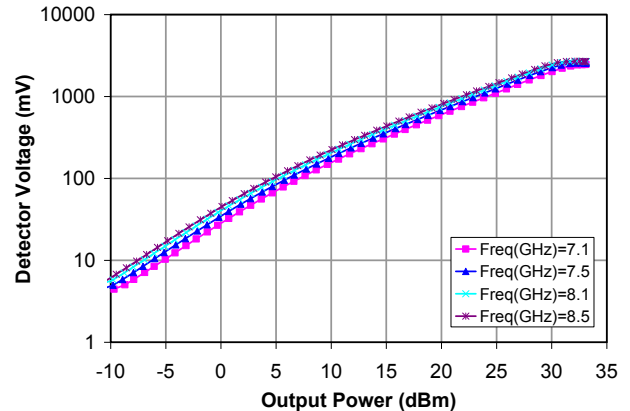

# XP1050-QJ



2.5 W Power Amplifier  
7.1 - 8.5 GHz

Rev. V1

Lead-Free 6 mm 24-Lead PQFN<sup>†</sup>

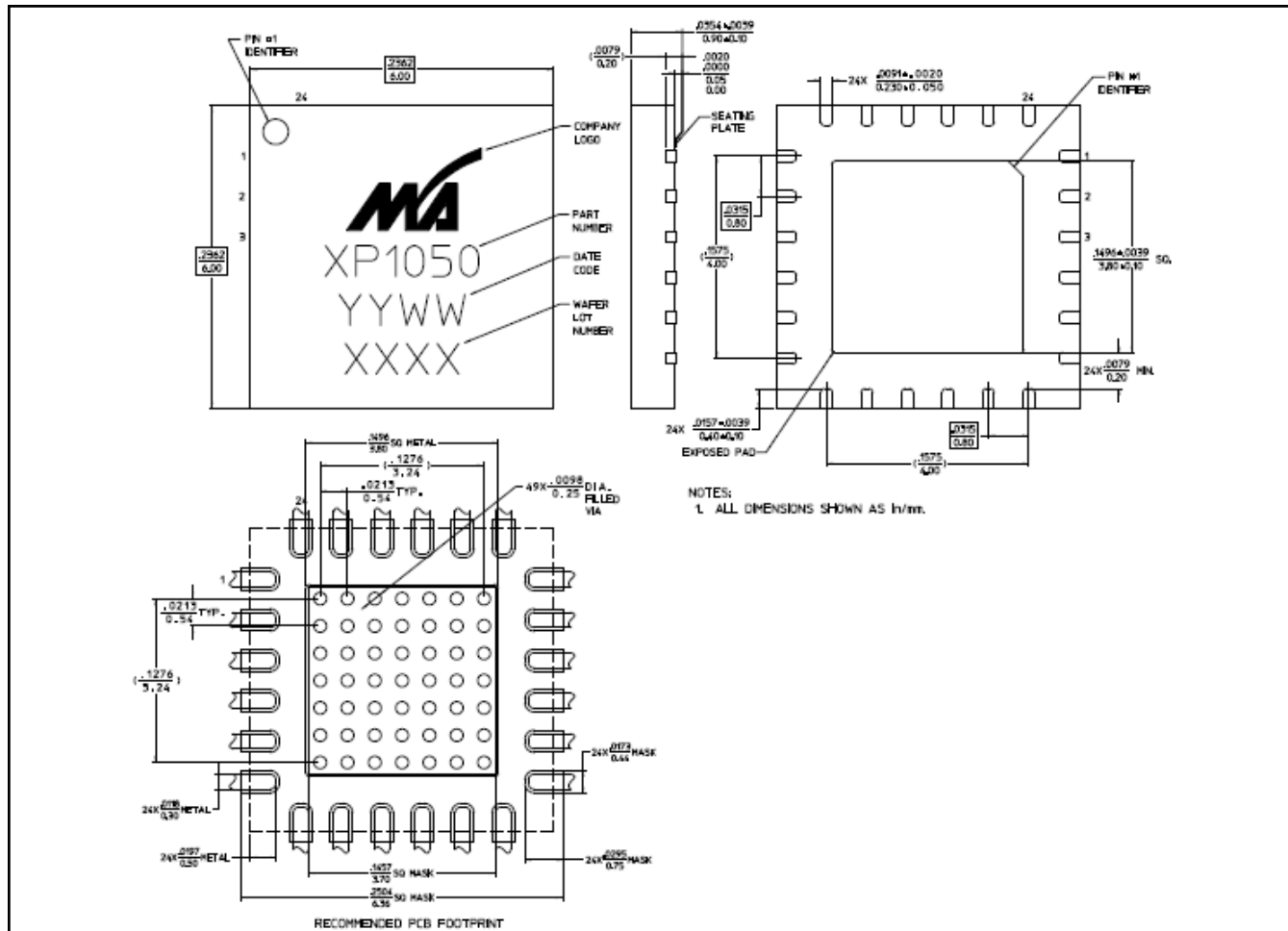

<sup>†</sup> Reference Application Note S2083 for lead-free solder reflow recommendations.  
Meets JEDEC moisture sensitivity level 3 requirements.  
Plating is 100% matte tin over copper.

M/A-COM Technology Solutions Inc. All rights reserved.

Information in this document is provided in connection with M/A-COM Technology Solutions Inc ("MACOM") products. These materials are provided by MACOM as a service to its customers and may be used for informational purposes only. Except as provided in MACOM's Terms and Conditions of Sale for such products or in any separate agreement related to this document, MACOM assumes no liability whatsoever. MACOM assumes no responsibility for errors or omissions in these materials. MACOM may make changes to specifications and product descriptions at any time, without notice. MACOM makes no commitment to update the information and shall have no responsibility whatsoever for conflicts or incompatibilities arising from future changes to its specifications and product descriptions. No license, express or implied, by estoppel or otherwise, to any intellectual property rights is granted by this document.

THESE MATERIALS ARE PROVIDED "AS IS" WITHOUT WARRANTY OF ANY KIND, EITHER EXPRESS OR IMPLIED, RELATING TO SALE AND/OR USE OF MACOM PRODUCTS INCLUDING LIABILITY OR WARRANTIES RELATING TO FITNESS FOR A PARTICULAR PURPOSE, CONSEQUENTIAL OR INCIDENTAL DAMAGES, MERCHANTABILITY, OR INFRINGEMENT OF ANY PATENT, COPYRIGHT OR OTHER INTELLECTUAL PROPERTY RIGHT. MACOM FURTHER DOES NOT WARRANT THE ACCURACY OR COMPLETENESS OF THE INFORMATION, TEXT, GRAPHICS OR OTHER ITEMS CONTAINED WITHIN THESE MATERIALS. MACOM SHALL NOT BE LIABLE FOR ANY SPECIAL, INDIRECT, INCIDENTAL, OR CONSEQUENTIAL DAMAGES, INCLUDING WITHOUT LIMITATION, LOST REVENUES OR LOST PROFITS, WHICH MAY RESULT FROM THE USE OF THESE MATERIALS.

MACOM products are not intended for use in medical, lifesaving or life sustaining applications. MACOM customers using or selling MACOM products for use in such applications do so at their own risk and agree to fully indemnify MACOM for any damages resulting from such improper use or sale.

8

---

M/A-COM Technology Solutions Inc. (MACOM) and its affiliates reserve the right to make changes to the product(s) or information contained herein without notice.  
Visit [www.macom.com](http://www.macom.com) for additional data sheets and product information.



## X-ON Electronics

Largest Supplier of Electrical and Electronic Components

*Click to view similar products for [RF Amplifier](#) category:*

*Click to view products by [MACOM](#) manufacturer:*

Other Similar products are found below :

[A82-1](#) [BGA622H6820XTSA1](#) [BGA 728L7 E6327](#) [BGB719N7ESDE6327XTMA1](#) [HMC397-SX](#) [HMC405](#) [HMC561-SX](#) [HMC8120-SX](#)  
[HMC8121-SX](#) [HMC-ALH382-SX](#) [HMC-ALH476-SX](#) [SE2433T-R](#) [SMA3101-TL-E](#) [SMA39](#) [A66-1](#) [A66-3](#) [A67-1](#) [LX5535LQ](#) [LX5540LL](#)  
[MAAM02350](#) [HMC3653LP3BETR](#) [HMC549MS8GETR](#) [HMC-ALH435-SX](#) [SMA101](#) [SMA32](#) [SMA411](#) [SMA531](#) [SST12LP17E-XX8E](#)  
[SST12LP19E-QX6E](#) [WPM0510A](#) [HMC5929LS6TR](#) [HMC5879LS7TR](#) [HMC1126](#) [HMC1087F10](#) [HMC1086](#) [HMC1016](#) [SMA1212](#)  
[MAX2689EWS+T](#) [MAAMSS0041TR](#) [MAAM37000-A1G](#) [LTC6430AIUF-15#PBF](#) [CHA5115-QDG](#) [SMA70-2](#) [SMA4011](#) [A231](#) [HMC-](#)  
[AUH232](#) [LX5511LQ](#) [LX5511LQ-TR](#) [HMC7441-SX](#) [HMC-ALH310](#)