

Features

- Integrated LNA, Mixer and LO Multiplier
- 2.5 dB Noise Figure
- 13.0 dB Conversion Gain
- Lead-Free 4 mm 24-lead QFN Package
- 100% RF, DC and NF Testing
- RoHS* Compliant and 260°C Reflow Compatible

Description

The XR1019-QH is a 27.0-34.0 GHz QFN packaged receiver that has a noise figure of 2.5 dB and 13 dB conversion gain. The device integrates an LNA, image reject mixer and LO multiplier and buffer amplifier within a fully molded 4×4 mm QFN package. The image reject mixer eliminates the need for a band pass filter after the LNA to remove thermal noise at the image frequency. I and Q mixer outputs are provided and an external 90 degree hybrid is required to select the desired sideband.

This device is specifically designed for Point to Point radio applications and is well suited for other telecom applications such as SATCOM and VSAT.

Functional Schematic

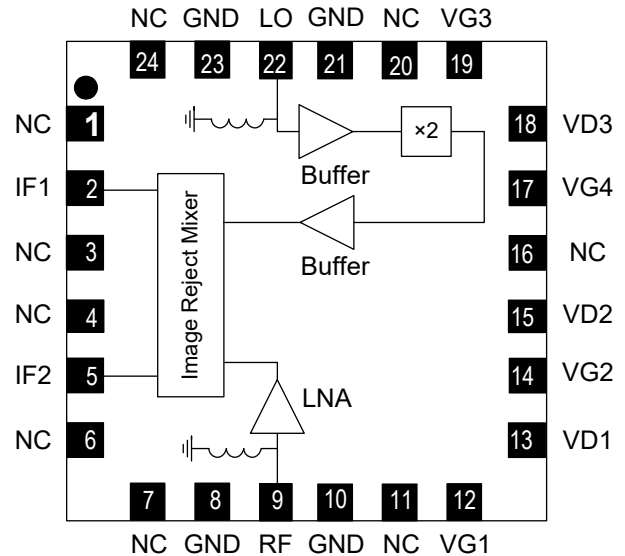

Pin Configuration ²

Pin No.	Function	Pin No.	Function
2	IF1 Output	15	Drain LNA Stage 2
5	IF2 Output	17	Mixer Bias
8	Ground	18	Drain, LO Buffer
9	RF Input	19	Gate, LO Buffer
10	Ground	21	Ground
12	Gate LNA Stage 1	22	LO Input
13	Drain LNA Stage 2	23	Ground
14	Gate LNA Stage 2	1,3,4,6,7,11,16,20,24	Not Connected

Ordering Information ¹

Part Number	Package
XR1019-QH-0G00	bulk quantity
XR1019-QH-0G0T	tape and reel
XR1019-QH-EV1	evaluation module

1. Reference Application Note M513 for reel size information.

2. The exposed pad centered on the package bottom must be connected to RF and DC ground.

* Restrictions on Hazardous Substances, European Union Directive 2011/65/EU.

Receiver
27 - 34 GHz

Rev. V2

Electrical Specifications: 27 - 34 GHz (RF), $T_A = +25^\circ\text{C}$

Parameter	Units	Min.	Typ.	Max.
Frequency Range (LO)	GHz	12.5	-	18.0
Frequency Range (IF)	GHz	DC	-	2.0
Conversion Gain (CG)	dB	-	13	-
Noise Figure (NF)	dB	-	2.5	-
Input Third Order Intercept (IIP3)	dBm	-	-2	-
Image Rejection	dBc	-	20	-
LO Input Drive	dBm	3	4	9
2×LO to RF Isolation	dBm	-	-25	-
RF Input Return Loss	dB	-	10	-
LO Input Return Loss	dB	-	10	-
IF Return Loss	dB	-	12	-
Drain Bias Voltage ($V_{D1,2,3}$)	VDC	-	3	-
Gate Bias Voltage ($V_{G1,2,3}$) ³	VDC	-	-0.35	-
Gate Bias Voltage (V_{G4}) ⁴	VDC	-3.8	-3.0	-2.0
Supply Current (I_{D1})	mA	-	7.5	-
Supply Current (I_{D2})	mA	-	30	-
Supply Current (I_{D3})	mA	-	90	-
Supply Current (I_{G4})	mA	-	10	-

3. $V_{G1,2}$ and 3 are adjusted to achieve constant drain current regulation.4. V_{G4} provides mixer bias and is fixed at -3.0 V.

Absolute Maximum Ratings ^{5,6}

Parameter	Absolute Maximum
Supply Voltage ($V_D1,2,3$)	+4.3 V
Supply Current ($I_D1,2,3$)	200 mA
Gate Bias Voltage ($V_G1,2,3$)	-1.7 V min., 0 V max.
Gate Bias Voltage (V_G4)	-4 V
RF Input Power	+5 dBm
LO Input Power	+13 dBm
Storage Temperature (T_{stg})	-65°C to +150°C
Operating Temperature (T_a)	-55°C to +85°C
Channel Temperature (T_{ch})	+150°C
ESD-Machine Model	Class A
ESD-Human Body Model	Class 1A
Moisture Sensitivity Level	MSL3

5. Operation of this device above any one of these parameters may cause permanent damage.

6. Channel temperature directly affects a device's MTTF. Channel temperature should be kept as low as possible to maximize lifetime.

Recommended Board Layout

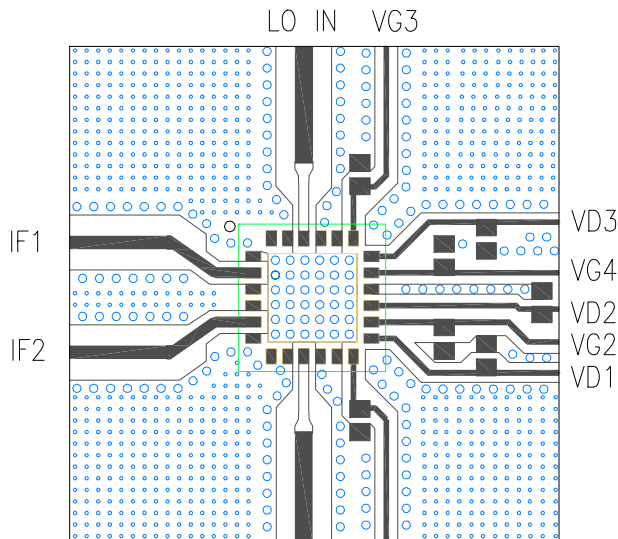

RF IN VG1
Recommended Decoupling Capacitors: 100pF 0402
10uF 0805
Recommend to externally ground all NC pins

App Note [1] Biasing - As shown in the Pin Designations table, the device is operated by biasing $V_D1,2,3$ at 3.0 V with 7.5, 30, 90 mA respectively. Additionally, a fixed voltage bias of -3 V is required for mixer bias. It is recommended to use active bias to keep the currents constant in order to maintain the best performance over temperature. Depending on the supply voltage available and the power dissipation constraints, the bias circuit may be a single transistor or a low power operational amplifier, with a low value resistor in series with the drain supply used to sense the current. The gate of the pHEMT is controlled to maintain correct drain current and thus drain voltage. The typical gate voltage needed to do this is -0.35 V. Make sure to sequence the applied voltage to ensure negative gate bias is available before applying the positive drain supply.

App Note [2] Board Layout - As shown in the board layout, it is recommended to provide 100 pF decoupling caps as close to the bias pins as possible, with additional 10 μ F decoupling caps.

Typical Performance Curves

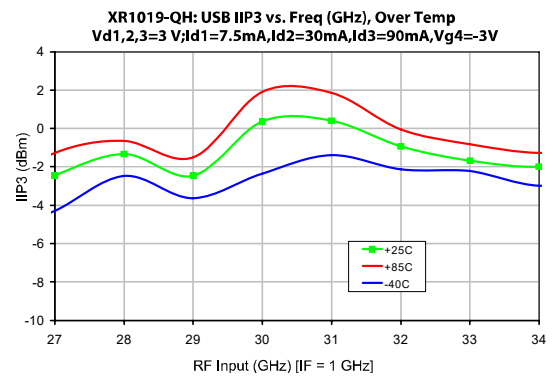
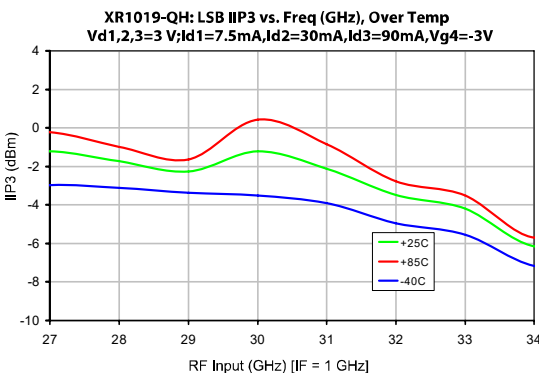
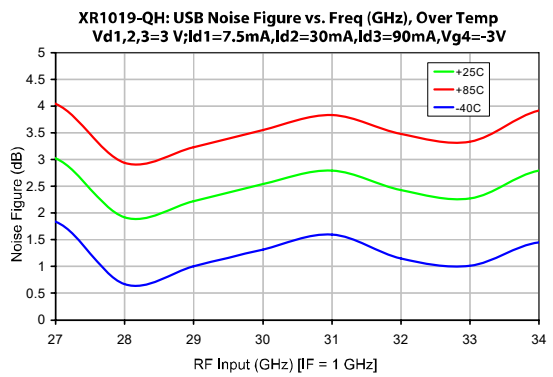
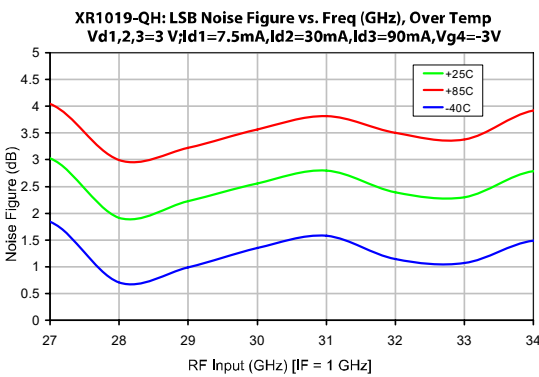
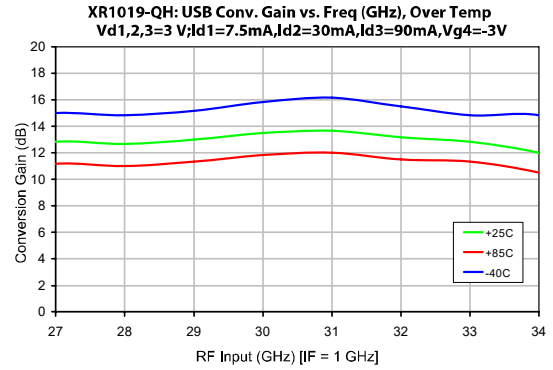
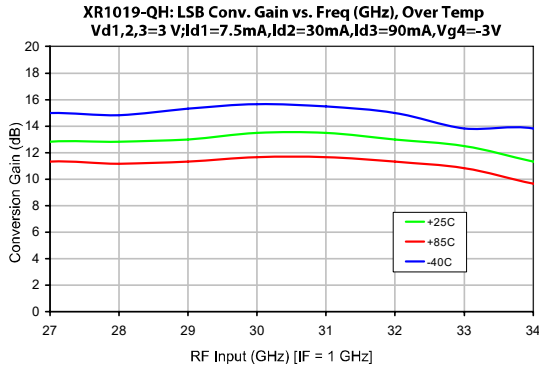

Typical Performance Curves (cont.)

XR1019-QH: LSB Image Rejection vs. Freq (GHz), Over Temp
Vd1,2,3=3 V; Id1=7.5mA, Id2=30mA, Id3=90mA, Vg4=-3V

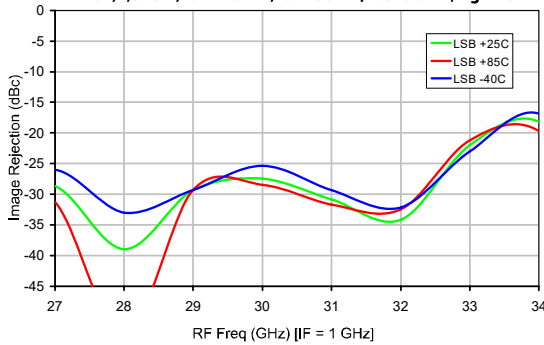

XR1019-QH: USB Image Rejection vs. Freq (GHz), Over Temp
Vd1,2,3=3 V; Id1=7.5mA, Id2=30mA, Id3=90mA, Vg4=-3V

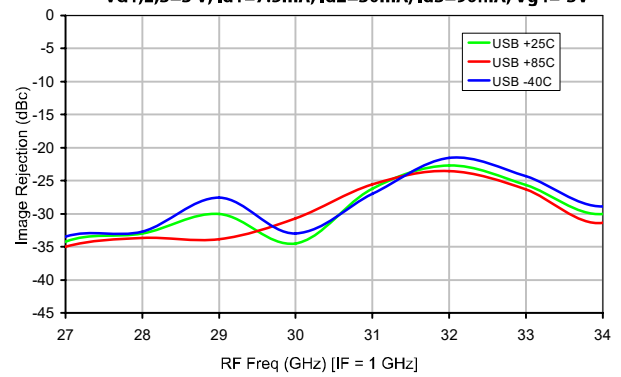

XR1019-QH: Conv. Gain vs IF Freq (GHz)
Vd1,2,3=3 V; Id1=7.5mA, Id2=30mA, Id3=90mA, Vg4=-3V

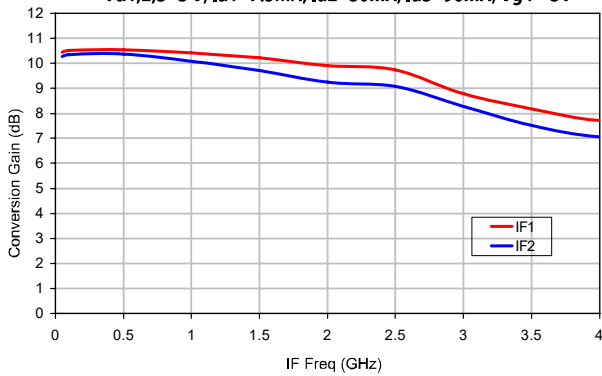

XR1019-QH: RF and LO Return Loss vs. Freq (GHz)
Vd1,2,3=3 V; Id1=7.5mA, Id2=30mA, Id3=90mA, Vg4=-3V

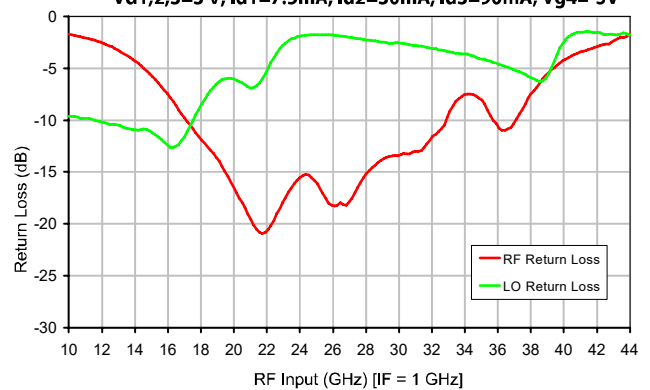

XR1019-QH: USB Conv. Gain vs Freq (GHz), Varying LO Power
Vd1,2,3=3 V; Id1=7.5mA, Id2=30mA, Id3=90mA, Vg4=-3V

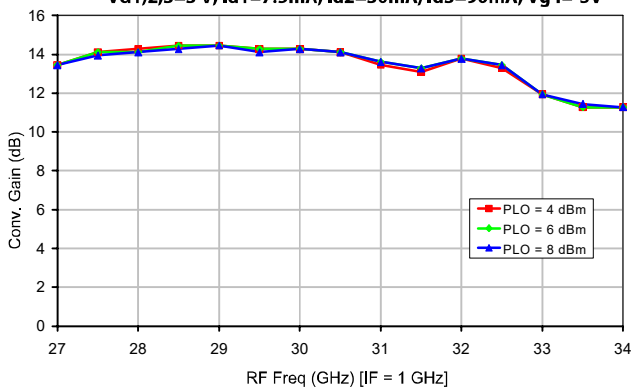

XR1019-QH: USB IIP3 vs Freq (GHz), Varying LO Power
Vd1,2,3=3 V; Id1=7.5mA, Id2=30mA, Id3=90mA, Vg4=-3V

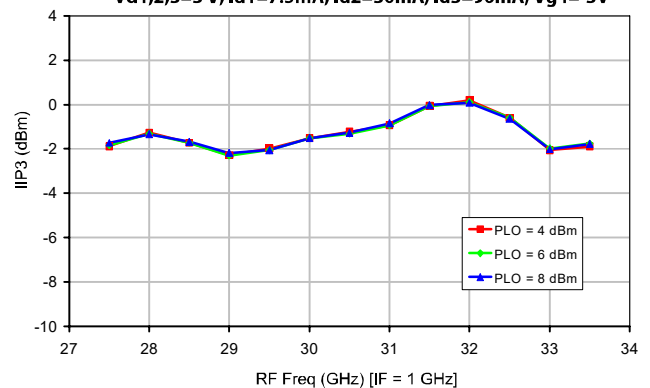

Typical Performance Curves (cont.)

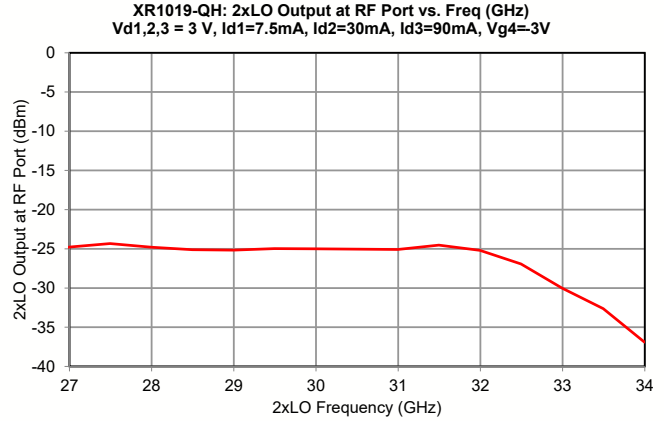
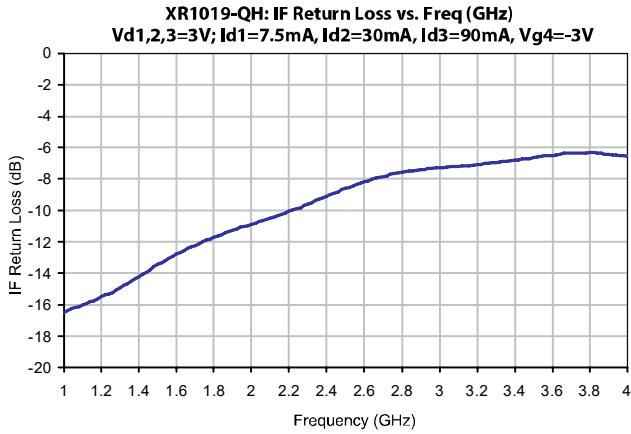

MTTF

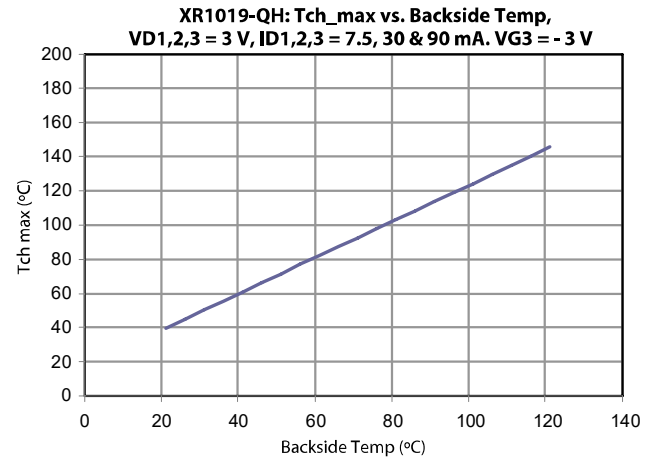
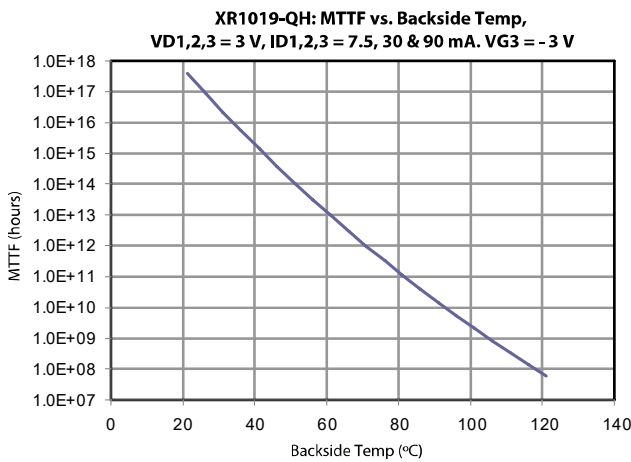

MTTF is calculated from accelerated life-time data of single devices and assumes an isothermal back-plate.

Receiver
27 - 34 GHz

Rev. V2

Lead-Free 4 mm 24-Lead PQFN[†]

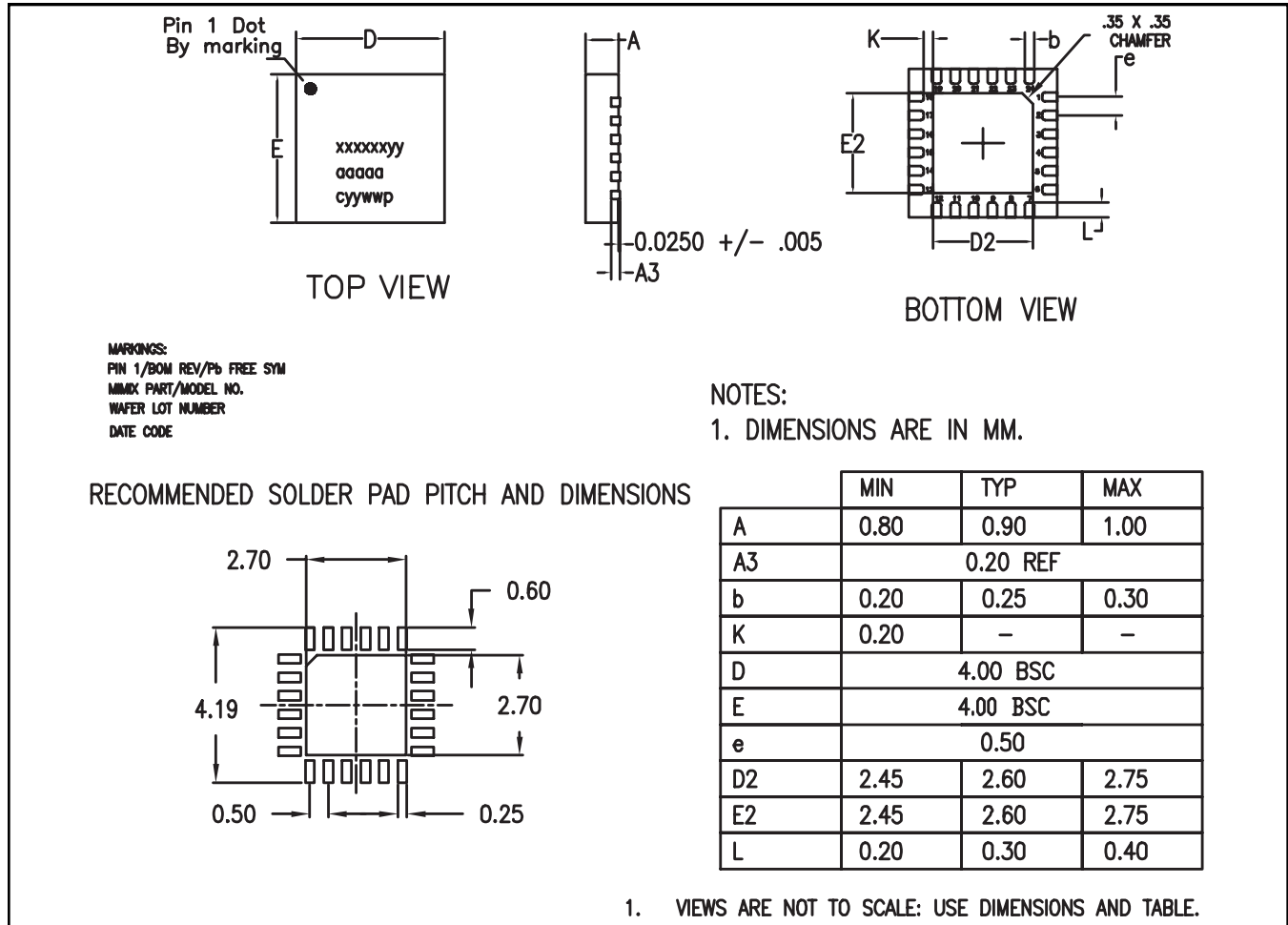

[†] Reference Application Note S2083 for lead-free solder reflow recommendations.
Plating is 100% matte tin over copper.

MACOM Technology Solutions Inc. All rights reserved.

Information in this document is provided in connection with MACOM Technology Solutions Inc ("MACOM") products. These materials are provided by MACOM as a service to its customers and may be used for informational purposes only. Except as provided in MACOM's Terms and Conditions of Sale for such products or in any separate agreement related to this document, MACOM assumes no liability whatsoever. MACOM assumes no responsibility for errors or omissions in these materials. MACOM may make changes to specifications and product descriptions at any time, without notice. MACOM makes no commitment to update the information and shall have no responsibility whatsoever for conflicts or incompatibilities arising from future changes to its specifications and product descriptions. No license, express or implied, by estoppels or otherwise, to any intellectual property rights is granted by this document.

THESE MATERIALS ARE PROVIDED "AS IS" WITHOUT WARRANTY OF ANY KIND, EITHER EXPRESS OR IMPLIED, RELATING TO SALE AND/OR USE OF MACOM PRODUCTS INCLUDING LIABILITY OR WARRANTIES RELATING TO FITNESS FOR A PARTICULAR PURPOSE, CONSEQUENTIAL OR INCIDENTAL DAMAGES, MERCHANTABILITY, OR INFRINGEMENT OF ANY PATENT, COPYRIGHT OR OTHER INTELLECTUAL PROPERTY RIGHT. MACOM FURTHER DOES NOT WARRANT THE ACCURACY OR COMPLETENESS OF THE INFORMATION, TEXT, GRAPHICS OR OTHER ITEMS CONTAINED WITHIN THESE MATERIALS. MACOM SHALL NOT BE LIABLE FOR ANY SPECIAL, INDIRECT, INCIDENTAL, OR CONSEQUENTIAL DAMAGES, INCLUDING WITHOUT LIMITATION, LOST REVENUES OR LOST PROFITS, WHICH MAY RESULT FROM THE USE OF THESE MATERIALS.

MACOM products are not intended for use in medical, lifesaving or life sustaining applications. MACOM customers using or selling MACOM products for use in such applications do so at their own risk and agree to fully indemnify MACOM for any damages resulting from such improper use or sale.

X-ON Electronics

Largest Supplier of Electrical and Electronic Components

Click to view similar products for [RF Transceiver](#) category:

Click to view products by [MACOM](#) manufacturer:

Other Similar products are found below :

[ATA5428C-PLQW-1](#) [ATA8520-GHPW](#) [XR1019-QH-0G0T](#) [AX5043-1-TW30](#) [MAX7043EUI](#) [ATA5428C-PLQW-1](#) [MAX2510EEI+T](#)
[AX5051-1-TW30](#) [ADRV9026-HB/PCBZ](#) [ADRV9026-MB/PCBZ](#) [BGT24LTR22E6327XTSA1](#) [ADL6316ACCZ](#) [ADL6316ACCZ-R7](#)
[ADL6317ACCZ](#) [SX1268DVK1GAS](#) [MC13213R2](#) [CC1260RGZT](#) [NRF51822-CEAA-R \(E0\)](#) [CC2590RGVR](#) [USB3317-GJ-TR](#) [USB3311-GJ-](#)
[TR](#) [MAX7030HATJ+T](#) [MAX2831ETM+](#) [MAX2830ETM+](#) [MAX2829ETN+](#) [MAX2828ETN+](#) [BH1406KV-E2](#) [SX1232BIMLTRT](#) [XBP24-](#)
[API-080](#) [ADF7242BCPZ-RL](#) [MAX2831ETM](#) [S2-LPQTR](#) [MAX7037EGL+](#) [ESP32-D0WDQ6](#) [ESP8266EX](#) [TRF2443IPFP](#) [CC8530RHAR](#)
[ADF7021-NBCPZ-RL](#) [CC1201RHBR](#) [TLE9221SXXUMA2](#) [TC35675XBG-001\(EL\)](#) [DA14585-00000AT2](#) [SX1281IMLTRT](#) [TC35661SBG-](#)
[501,EL](#) [ADS62PF49IRGCT](#) [TC32306FTG,EL](#) [NRF51822-QFAC-R](#) [CC1310F128RHBR](#) [AT86RF215IQ-ZUR](#) [A7108](#)