

Doubler 13.5-17.0/27.0-34.0 GHz

Rev. V1

Features

- Integrated Gain, Doubler and Driver Stages
- Single Positive Supply, +5V
- Integrated Bypassing Capacitor
- +20.0 dBm Output Saturated Power
- 35.0 dBc Fundamental Suppression
- On-Chip ESD Protection
- 100% RF, DC and Output Power Testing
- Lead-Free 3 mm 16-Lead QFN Package
- RoHS* Compliant and 260°C Reflow Compatible

Description

M/A-COM Tech's 13.5-17.0 / 27.0-34.0 GHz GaAs MMIC doubler integrates a gain stage, passive doubler and driver amplifier onto a single device. The XX1007-QT has a self-biased architecture requiring a single positive supply (+5V) only and integrated on-chip bypassing and DC blocking capacitors eliminating the need for any external components. This device uses M/A-COM Tech's GaAs PHEMT device model technology, and is based upon electron beam lithography to ensure high repeatability and uniformity. The XX1007-QT has integrated ESD structures for protection and comes in a low cost 3x3mm QFN package. The device is well suited for Millimeter wave Point-to-Point Radio, LMDS, SATCOM and VSAT applications.

Functional Block Diagram

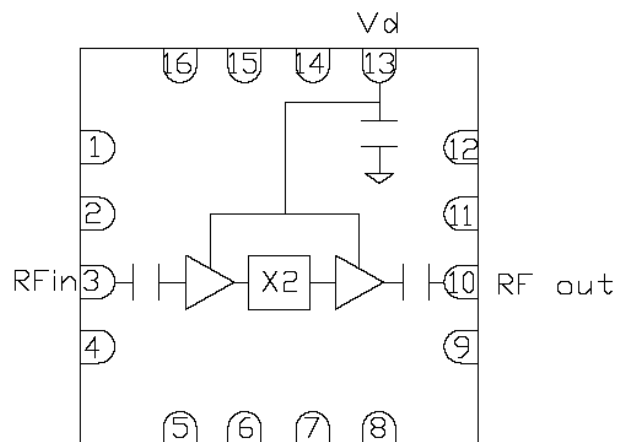

Pin Configuration

Pin No.	Function	Pin No.	Function
3	RF In	1,2,4,5,6,7,8,9	NC
10	RF Out	11,12,14,15,16	NC
13	Vd		

Absolute Maximum Ratings

Parameter	Absolute Max.
Supply Voltage (Vd)	+6.0 VDC
Supply Current (Id)	300 mA
Gate Bias Voltage (Vg)	+0.3 VDC
Input Power (RF Pin)	10 dBm
Storage Temperature (Tstg)	-65 to +165 °C
Operating Temperature (Ta)	-55 to MTTF Table ¹
Channel Temperature (Tch)	MTTF Table ¹

(1) Channel temperature directly affects a device's MTTF. It is recommended to keep channel temperature as low as possible to maximize lifetime.

Ordering Information

Part Number	Package
XX1007-QT-0G00	bulk quantity
XX1007-QT-0G0T	tape and reel
XX1007-QT-EV1	evaluation board

Doubler
13.5-17.0/27.0-34.0 GHz

Rev. V1

Electrical Specifications: 13.5-17 GHz (fin) (Ambient Temperature T = 25°C)

Parameter	Units	Min.	Typ.	Max.
Output Frequency Range (fout)	GHz	27.0	-	34.0
Input Return Loss (S11)	dB	-	-8.0	-
Output Return Loss (S22)	dB	-	-10.0	-
Fundamental Suppression	dBc	-28.0	-35.0	-
RF Input Power (RF Pin)	dBm	-	8.0	-
Output Power at 8.0 dBm Pin (Pout)	dBm	+16.0	+20.0	-
Drain Bias Voltage (Vd)	VDC	-	+5.0	+5.5
Supply Current (Id1,2,3) (Vd=5.0V Typical)	mA	-	200	240

Typical Performance Curves

XX1007-QT: Pout at Fin and 2X Fin, Pin = 10 dBm, Vd = 5V

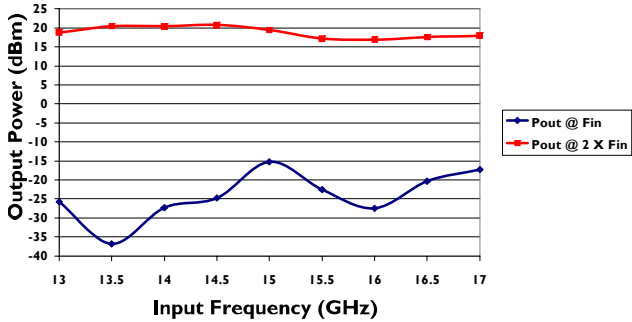

XX1007-QT: Pout at Fin and 2X Fin, Pin = 5 dBm, Vd = 5V

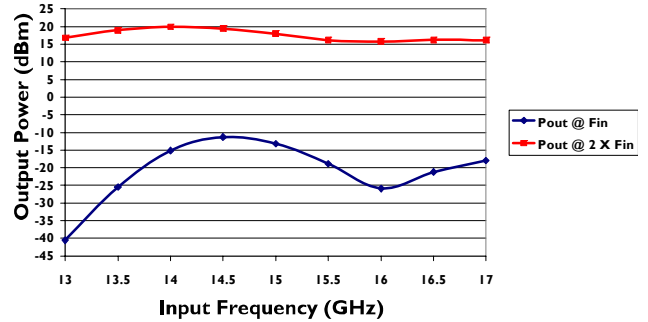

XX1007-QT: Pout at Fin and 2X Fin, Pin = 0 dBm, Vd = 5V

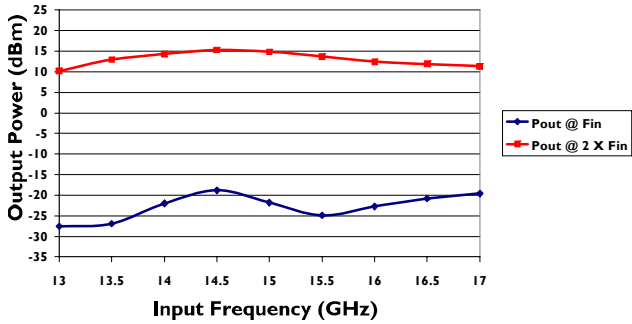

XX1007-QT: Pout at Fin and 2X Fin, Pin = 3 dBm, Vd = 5V

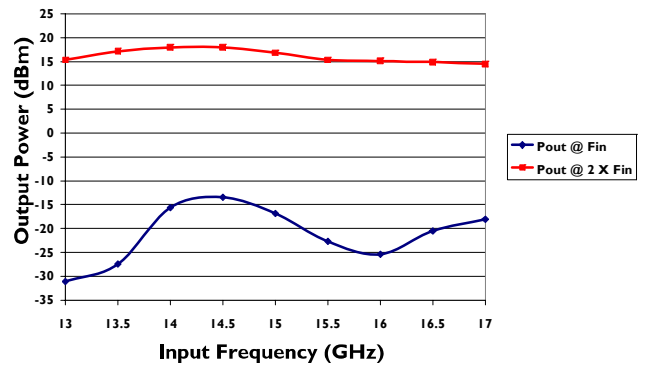

XX1007-QT: Pout Vs Pin, Vd = 5V, Input Frequency = 14.5 GHz

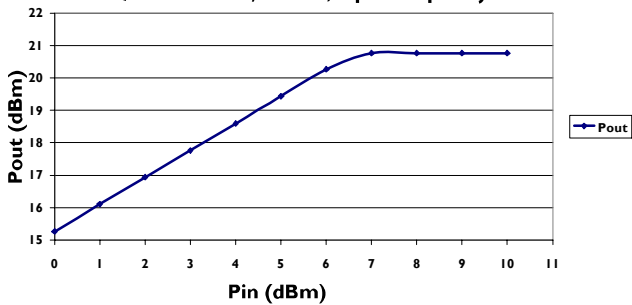

XX1007-QT: Pout Vs Pin, Input Frequency = 14.5 GHz

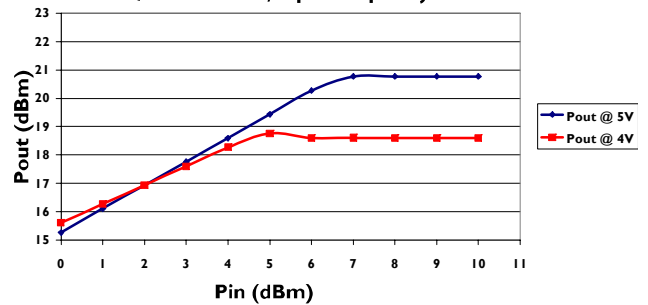

Typical Performance Curves

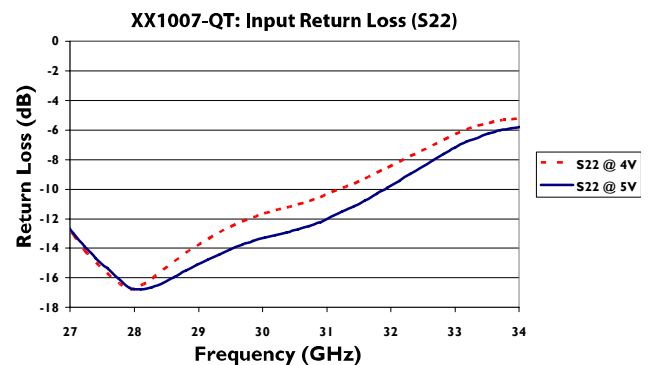
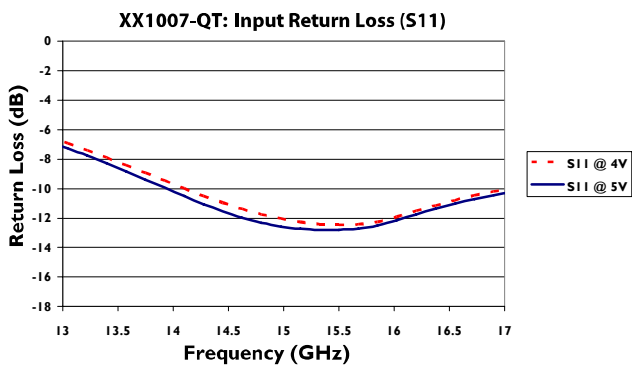
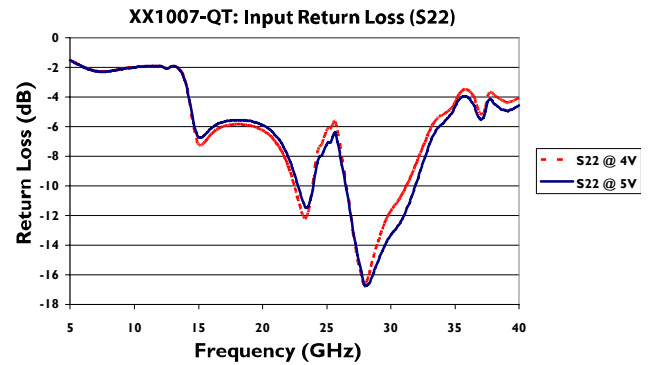
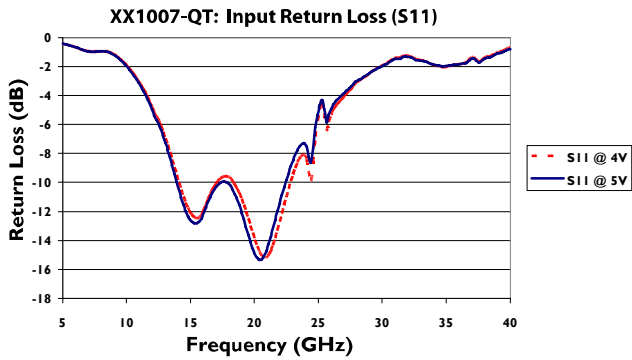
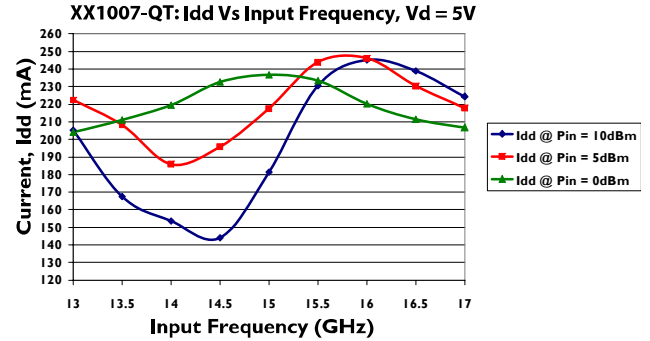
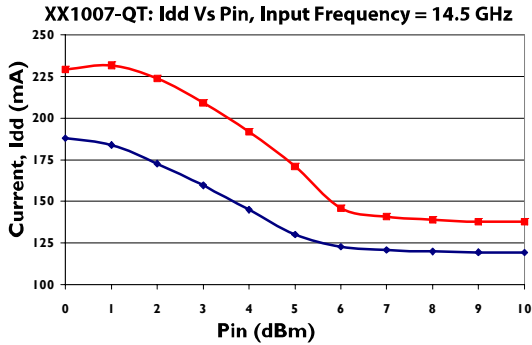

Evaluation Board Layout

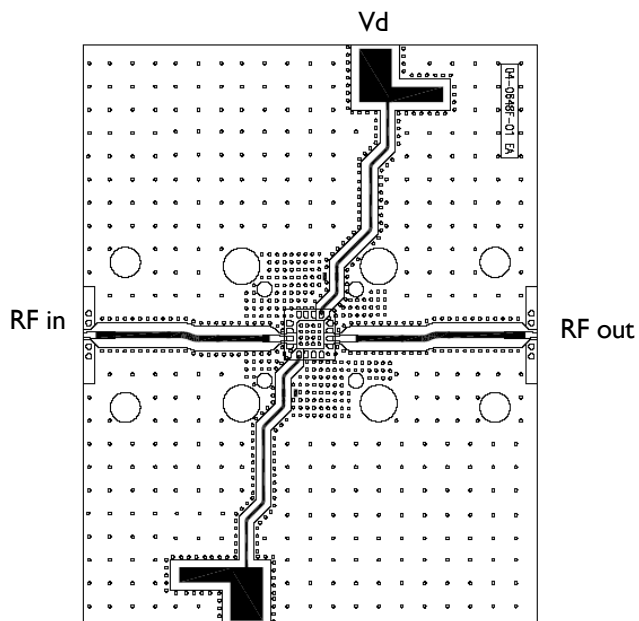

Handling Procedures

Please observe the following precautions to avoid damage:

Static Sensitivity

Gallium Arsenide Integrated Circuits are sensitive to electrostatic discharge (ESD) and can be damaged by static electricity. Proper ESD control techniques should be used when handling these class 2 devices.

MTTF Tables (TBD)

These numbers were calculated based on accelerated life test information and thermal model analysis received from the fabricating foundry.

Backplate Temperature	Channel Temperature	Rth	MTTF Hours	FITs
75 deg Celsius	192 deg Celsius	126 C/W	3.4 E+06	2.9 E+02

Bias Conditions: Vd=5.0V, Id=200mA

Doubler
13.5-17.0/27.0-34.0 GHz

Rev. V1

Lead-Free Package Dimensions/Layout

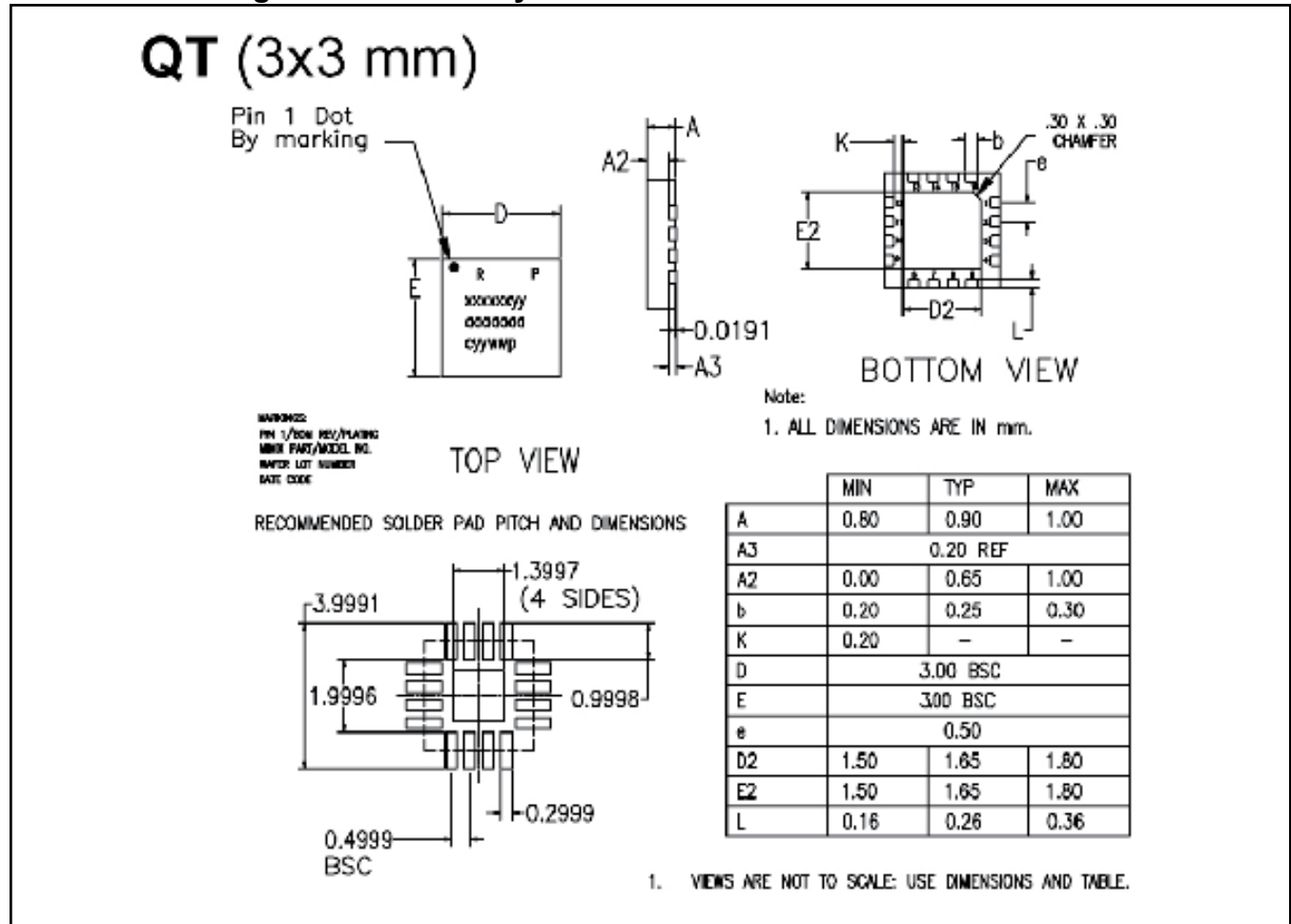

M/A-COM Technology Solutions Inc. All rights reserved.

Information in this document is provided in connection with M/A-COM Technology Solutions Inc ("MACOM") products. These materials are provided by MACOM as a service to its customers and may be used for informational purposes only. Except as provided in MACOM's Terms and Conditions of Sale for such products or in any separate agreement related to this document, MACOM assumes no liability whatsoever. MACOM assumes no responsibility for errors or omissions in these materials. MACOM may make changes to specifications and product descriptions at any time, without notice. MACOM makes no commitment to update the information and shall have no responsibility whatsoever for conflicts or incompatibilities arising from future changes to its specifications and product descriptions. No license, express or implied, by estoppel or otherwise, to any intellectual property rights is granted by this document.

THESE MATERIALS ARE PROVIDED "AS IS" WITHOUT WARRANTY OF ANY KIND, EITHER EXPRESS OR IMPLIED, RELATING TO SALE AND/OR USE OF MACOM PRODUCTS INCLUDING LIABILITY OR WARRANTIES RELATING TO FITNESS FOR A PARTICULAR PURPOSE, CONSEQUENTIAL OR INCIDENTAL DAMAGES, MERCHANTABILITY, OR INFRINGEMENT OF ANY PATENT, COPYRIGHT OR OTHER INTELLECTUAL PROPERTY RIGHT. MACOM FURTHER DOES NOT WARRANT THE ACCURACY OR COMPLETENESS OF THE INFORMATION, TEXT, GRAPHICS OR OTHER ITEMS CONTAINED WITHIN THESE MATERIALS. MACOM SHALL NOT BE LIABLE FOR ANY SPECIAL, INDIRECT, INCIDENTAL, OR CONSEQUENTIAL DAMAGES, INCLUDING WITHOUT LIMITATION, LOST REVENUES OR LOST PROFITS, WHICH MAY RESULT FROM THE USE OF THESE MATERIALS.

MACOM products are not intended for use in medical, lifesaving or life sustaining applications. MACOM customers using or selling MACOM products for use in such applications do so at their own risk and agree to fully indemnify MACOM for any damages resulting from such improper use or sale.

X-ON Electronics

Largest Supplier of Electrical and Electronic Components

Click to view similar products for [Signal Conditioning](#) category:

Click to view products by [MACOM](#) manufacturer:

Other Similar products are found below :

[MAPDCC0001](#) [MAPDCC0004](#) [PD0409J5050S2HF](#) [880157](#) [HHS-109-PIN](#) [DC1417J5005AHF](#) [AFS14A30-2185.00-T3](#) [AFS14A35-1591.50-T3](#) [DS-323-PIN](#) [B39321R801H210](#) [1A0220-3](#) [JP510S](#) [LFB212G45SG8C341](#) [LFB322G45SN1A504](#) [LFL182G45TC3B746](#) [SF2159E](#) [30057](#)
[FM-104-PIN](#) [CER0813B](#) [MAPDCC0005](#) [3A325](#) [40287](#) [41180](#) [ATB3225-75032NCT](#) [BD0810N50100AHF](#) [BD2425J50200AHF](#)
[C5060J5003AHF](#) [JHS-115-PIN](#) [JP503AS](#) [DC0710J5005AHF](#) [DC2327J5005AHF](#) [DC3338J5005AHF](#) [43020](#) [LFB2H2G60BB1C106](#)
[LFL15869MTC1B787](#) [X3C19F1-20S](#) [XC3500P-20S](#) [10013-20](#) [SF2194E](#) [CDBLB455KCAX39-B0](#) [TGL2208-SM, EVAL](#) [RF1353C](#)
[PD0922J5050D2HF](#) [1E1305-3](#) [1G1304-30](#) [B0922J7575AHF](#) [2020-6622-20](#) [TP-102-PIN](#) [TP-103-PIN](#) [BD1222J50200AHF](#)