

MDS9651

Complementary N-P Channel Trench MOSFET

General Description

The MDS9651 uses advanced MagnaChip's MOSFET Technology to provide low on-state resistance, high switching performance and excellent reliability

Features

- | | |
|--|---|
| <p>N-Channel</p> <ul style="list-style-type: none"> ▫ $V_{DS} = 30V$ ▫ $I_D = 6.9A @ V_{GS} = 10V$ ▫ $R_{DS(ON)} < 28m\Omega @ V_{GS} = 10V$ ▫ $R_{DS(ON)} < 42m\Omega @ V_{GS} = 4.5V$ | <p>P-Channel</p> <ul style="list-style-type: none"> $V_{DS} = -30V$ $I_D = -6.0A @ V_{GS} = -10V$ $R_{DS(ON)} < 35m\Omega @ V_{GS} = -10V$ $R_{DS(ON)} < 55m\Omega @ V_{GS} = -4.5V$ |
|--|---|

Applications

- Inverters
- General purpose applications

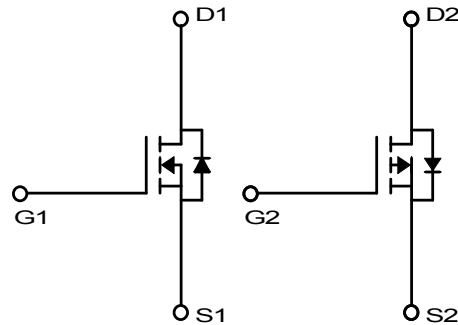
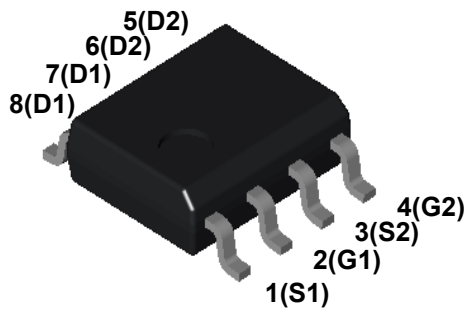

Absolute Maximum Ratings ($T_a = 25^\circ C$ unless otherwise noted)

Characteristics	Symbol	Rating		Unit	
		N-Ch	P-Ch		
Drain-Source Voltage	V_{DSS}	30	-30	V	
Gate-Source Voltage	V_{GSS}	± 20	± 20	V	
Continuous Drain Current	I_D	$T_a = 25^\circ C$	6.9	-6.0	A
		$T_a = 100^\circ C$	4.3	-4.1	A
Pulsed Drain Current	I_{DM}	30	-30	A	
Power Dissipation ⁽¹⁾	P_D	$T_a = 25^\circ C$	2	2	W
		$T_a = 100^\circ C$	0.8	0.8	W
Single Pulse Avalanche Energy ⁽²⁾	E_{AS}	18	60.5	mJ	
Junction and Storage Temperature Range	T_J, T_{stg}	-55~150		$^\circ C$	

Thermal Characteristics

Characteristics	Device	Symbol	Rating	Unit
Thermal Resistance, Junction-to-Ambient(Steady-State) ⁽¹⁾	N-Ch	$R_{\theta JA}$	62.5	$^\circ C/W$
Thermal Resistance, Junction-to-Case	N-Ch	$R_{\theta JC}$	60	
Thermal Resistance, Junction-to-Ambient(Steady-State) ⁽¹⁾	P-Ch	$R_{\theta JA}$	62.5	
Thermal Resistance, Junction-to-Case	P-Ch	$R_{\theta JC}$	40	

Ordering Information

Part Number	Temp. Range	Package	Packing	RoHS Status
MDS9651URH	-55~150°C	SOIC-8	Tape & Reel	Halogen Free

N-channel Electrical Characteristics (T_a = 25°C unless otherwise noted)

Characteristics	Symbol	Test Condition	Min	Typ	Max	Unit
Static Characteristics						
Drain-Source Breakdown Voltage	BV _{DSS}	I _D = 250μA, V _{GS} = 0V	30	-	-	V
Gate Threshold Voltage	V _{GS(th)}	V _{DS} = V _{GS} , I _D = 250μA	1.0	1.9	3.0	
Drain Cut-Off Current	I _{DSS}	V _{DS} = 24V, V _{GS} = 0V	-	-	1.0	μA
Gate Leakage Current	I _{GSS}	V _{GS} = ±20V, V _{DS} = 0V	-	-	0.1	
Drain-Source ON Resistance	R _{DS(on)}	V _{GS} = 10V, I _D = 6.9A	-	21.5	28.0	mΩ
		V _{GS} = 4.5V, I _D = 5.0A	-	31.5	42.0	
Forward Transconductance	g _{FS}	V _{DS} = 5V, I _D = 6.9A	-	15.4	-	S
Dynamic Characteristics						
Total Gate Charge	Q _g	V _{DS} = 15V, I _D = 6.9A, V _{GS} = 10V	-	6.94	-	nC
Gate-Source Charge	Q _{gs}		-	1.54	-	
Gate-Drain Charge	Q _{gd}		-	1.96	-	
Input Capacitance	C _{iss}	V _{DS} = 15V, V _{GS} = 0V, f = 1.0MHz	-	334	-	pF
Reverse Transfer Capacitance	C _{rss}		-	48	-	
Output Capacitance	C _{oss}		-	83	-	
Turn-On Delay Time	t _{d(on)}	V _{GS} = 10V, V _{DS} = 15V, R _L = 2.2Ω, R _{GEN} = 3Ω	-	3.5	-	ns
Turn-On Rise Time	t _r		-	25.4	-	
Turn-Off Delay Time	t _{d(off)}		-	14.2	-	
Turn-Off Fall Time	t _f		-	10.5	-	
Drain-Source Body Diode Characteristics						
Source-Drain Diode Forward Voltage	V _{SD}	I _S = 1A, V _{GS} = 0V	-	0.75	1.0	V
Body Diode Reverse Recovery Time	t _{rr}	I _F = 6.9A, di/dt = 100A/μs	-	16.5	-	ns
Body Diode Reverse Recovery Charge	Q _{rr}		-	7.8	-	nC

Note :

1. Surface mounted FR-4 board with 2oz. Copper.
2. Starting T_J = 25°C, L = 1mH, I_{AS} = 6A, V_{DD} = 15V, V_{GS} = 10V

P-channel Electrical Characteristics (T_a = 25°C unless otherwise noted)

Characteristics	Symbol	Test Condition	Min	Typ	Max	Unit
Static Characteristics						
Drain-Source Breakdown Voltage	BV _{DSS}	I _D = -250μA, V _{GS} = 0V	-30	-	-	V
Gate Threshold Voltage	V _{GS(th)}	V _{DS} = V _{GS} , I _D = -250μA	-1.0	-1.9	-3.0	
Drain Cut-Off Current	I _{DSS}	V _{DS} = -24V, V _{GS} = 0V	-	-	-1.0	μA
Gate Leakage Current	I _{GSS}	V _{GS} = ±20V, V _{DS} = 0V	-	-	±0.1	
Drain-Source ON Resistance	R _{DS(ON)}	V _{GS} = -10V, I _D = -6.0A	-	30.5	35.0	mΩ
		V _{GS} = -4.5V, I _D = -5.0A	-	41.5	55.0	
Forward Transconductance	g _{FS}	V _{DS} = -5V, I _D = -6.0A	-	13	-	S
Dynamic Characteristics						
Total Gate Charge	Q _g	V _{DS} = -15V, I _D = -6.0A, V _{GS} = -10V	-	18.4	-	nC
Gate-Source Charge	Q _{gs}		-	3.1	-	
Gate-Drain Charge	Q _{gd}		-	3.6	-	
Input Capacitance	C _{iss}	V _{DS} = -15V, V _{GS} = 0V, f = 1.0MHz	-	874	-	pF
Reverse Transfer Capacitance	C _{rss}		-	103	-	
Output Capacitance	C _{oss}		-	166	-	
Turn-On Delay Time	t _{d(on)}	V _{GS} = -10V, V _{DS} = -15V, R _L = 2.7Ω, R _{GEN} = 3Ω	-	9.8	-	ns
Turn-On Rise Time	t _r		-	29.8	-	
Turn-Off Delay Time	t _{d(off)}		-	26.3	-	
Turn-Off Fall Time	t _f		-	8.6	-	
Drain-Source Body Diode Characteristics						
Source-Drain Diode Forward Voltage	V _{SD}	I _S = -1A, V _{GS} = 0V	-	-0.75	-1.0	V
Body Diode Reverse Recovery Time	t _{rr}	I _F = -6.0A, di/dt = 100A/μs	-	20	-	ns
Body Diode Reverse Recovery Charge	Q _{rr}		-	12.3	-	nC

Note :

1. Surface mounted RF4 board with 2oz. Copper.
2. Starting T_J = 25°C, L = 1mH, I_{AS} = -11A, V_{DD} = -15V, V_{GS} = -10V

N-CHANNEL TYPICAL ELECTRICAL AND THERMAL CHARACTERISTICS

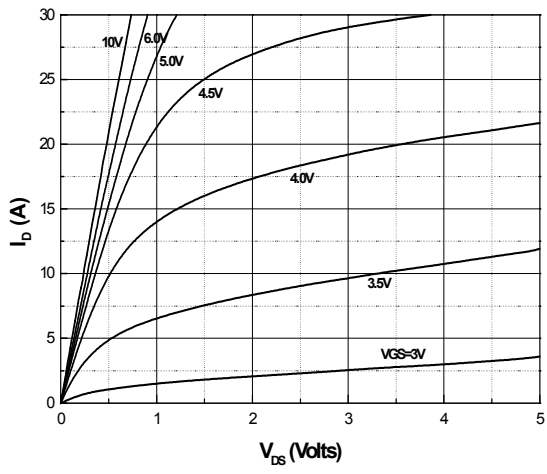

Fig.1 On-Region Characteristics

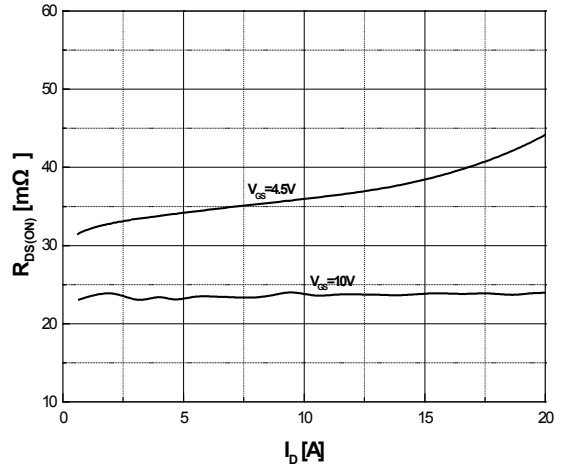

Fig.2 On-Resistance Variation with Drain Current and Gate Voltage

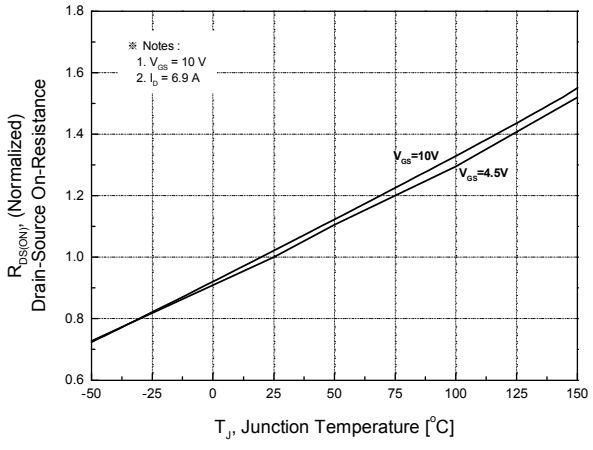

Fig.3 On-Resistance Variation with Temperature

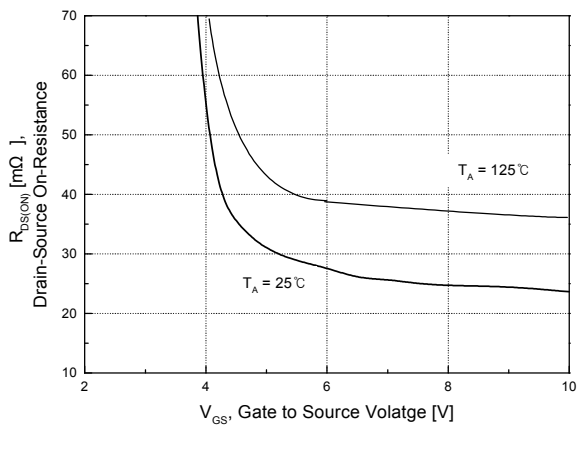

Fig.4 On-Resistance Variation with Gate to Source Voltage

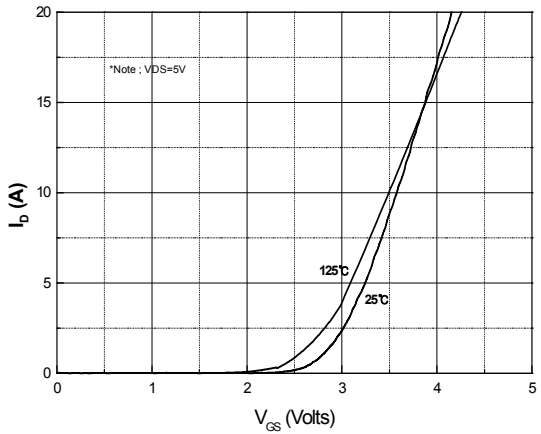

Fig.5 Transfer Characteristics

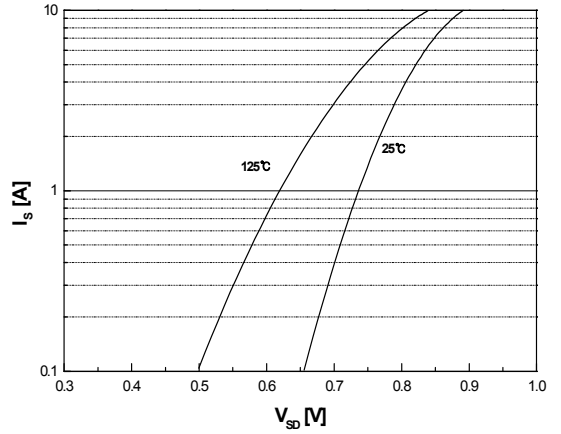

Fig.6 Body Diode Forward Voltage Variation with Source Current and Temperature

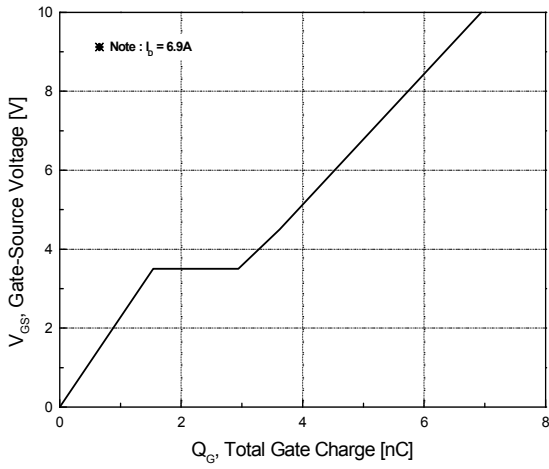

Fig.7 Gate Charge Characteristics

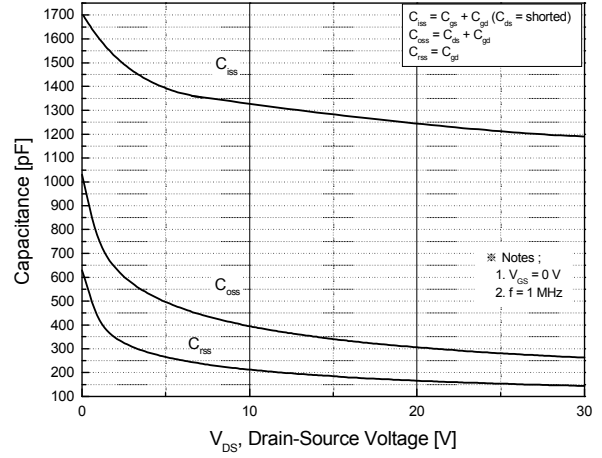

Fig.8 Capacitance Characteristics

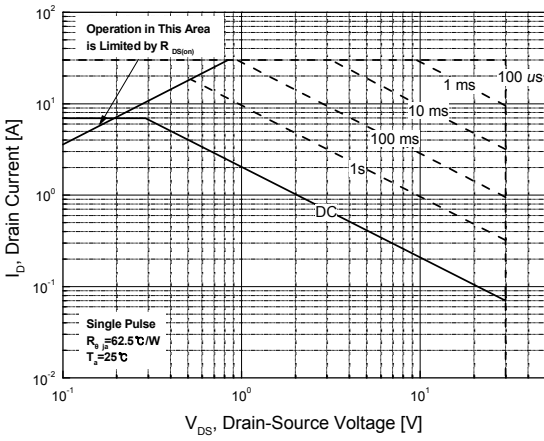

Fig.9 Maximum Safe Operating Area

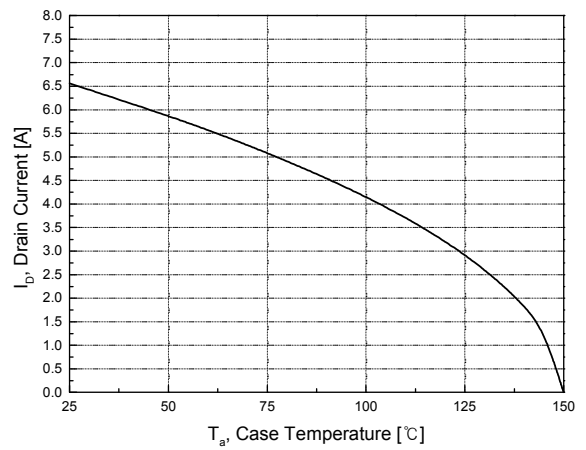

Fig.10 Maximum Drain Current Vs. Case Temperature

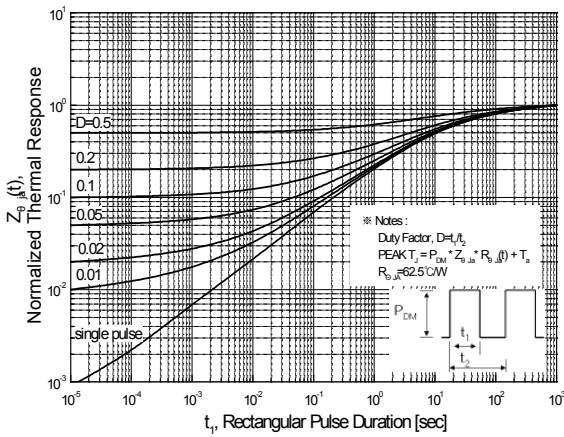

Fig.11 Transient Thermal Response Curve

P-CHANNEL TYPICAL ELECTRICAL AND THERMAL CHARACTERISTICS

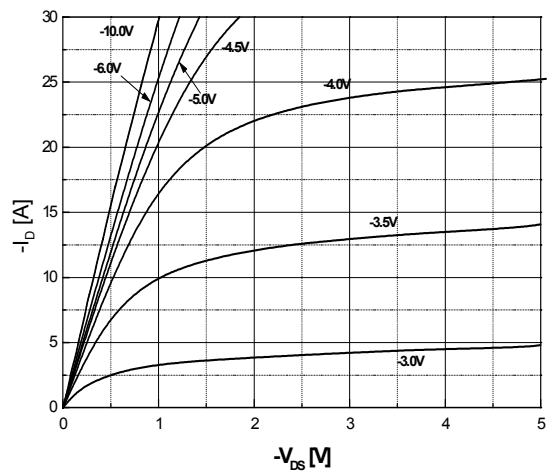

Fig.1 On-Region Characteristics

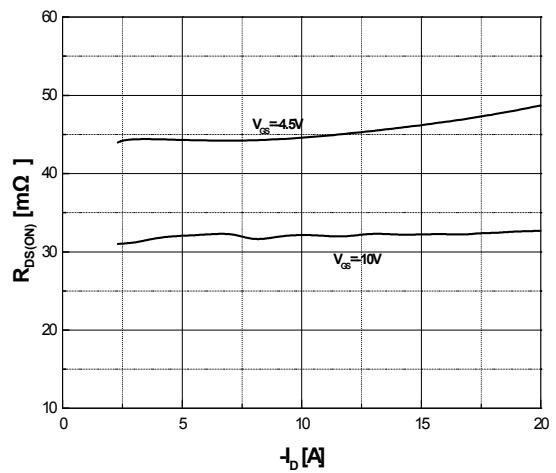

Fig.2 On-Resistance Variation with Drain Current and Gate Voltage

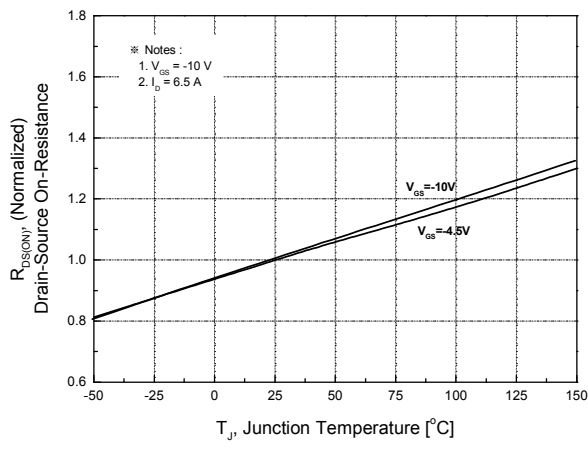

Fig.3 On-Resistance Variation with Temperature

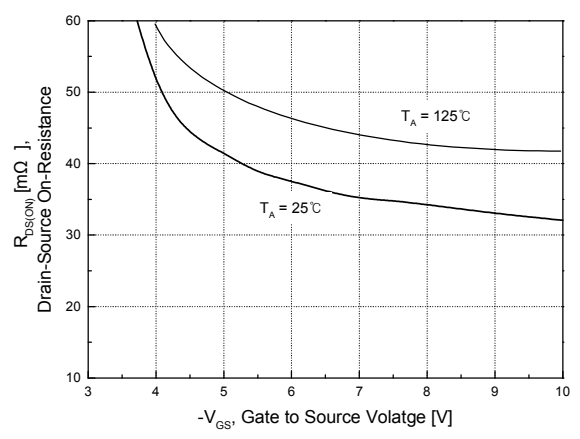

Fig.4 On-Resistance Variation with Gate to Source Voltage

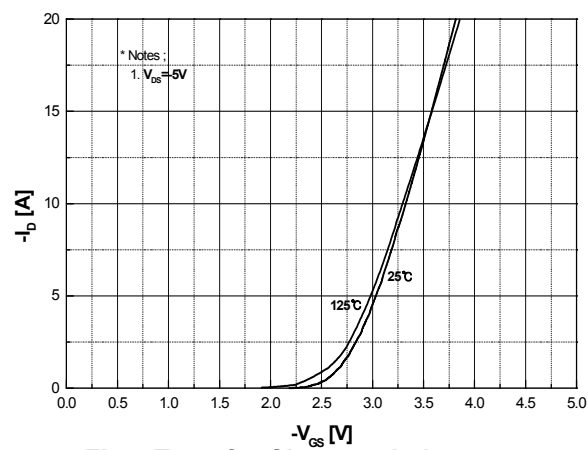

Fig.5 Transfer Characteristics

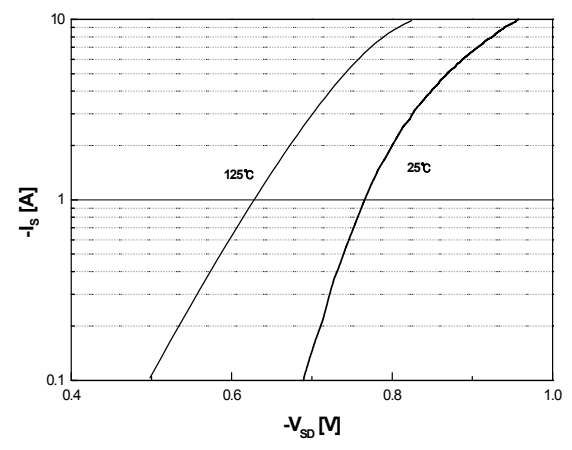

Fig.6 Body Diode Forward Voltage Variation with Source Current and Temperature

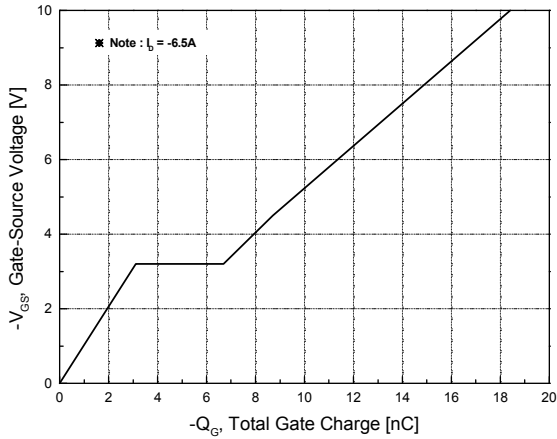

Fig.7 Gate Charge Characteristics

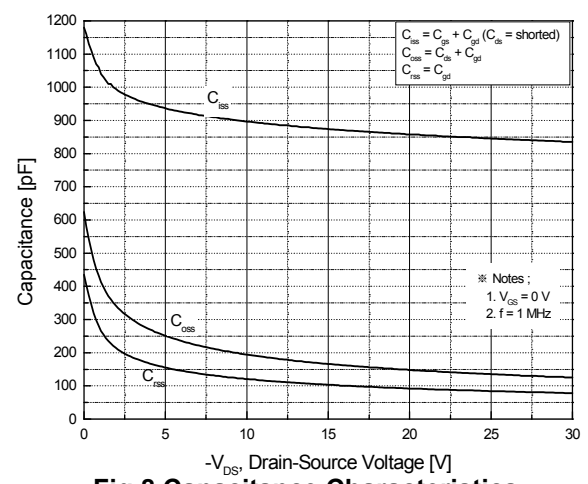

Fig.8 Capacitance Characteristics

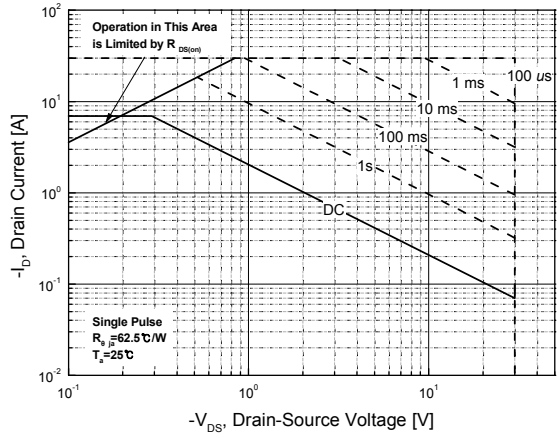

Fig.9 Maximum Safe Operating Area

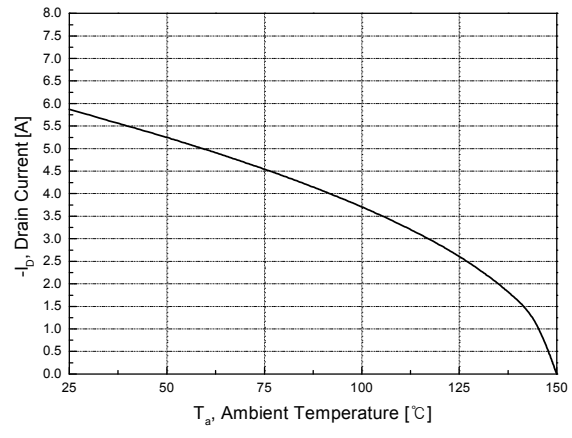

Fig.10 Maximum Drain Current vs. Case Temperature

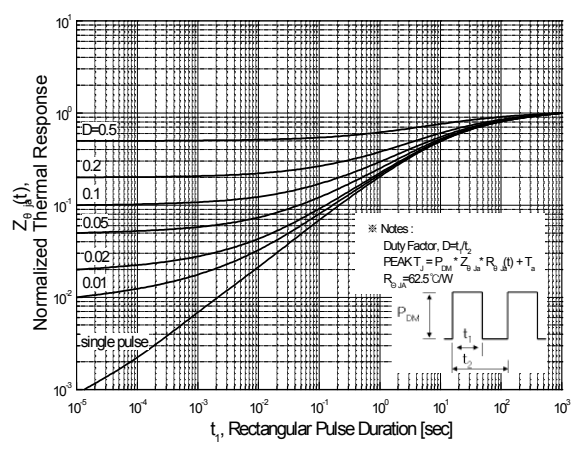
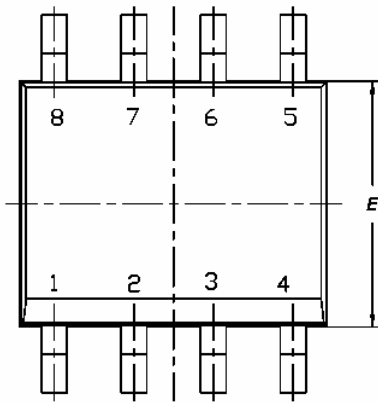

Fig.11 Transient Thermal Response Curve

Physical Dimensions

8 Leads SOIC

Dimensions are in millimeters unless otherwise specified



DIM.	MILLIMETERS		
	MIN.	NOM.	MAX.
A	1.35	1.55	1.75
A(1)	0.10	0.175	0.25
B	0.38	0.445	0.51
C	0.19	0.22	0.25
D	4.80	4.90	5.00
E	3.80	3.90	4.00
e	1.27 BSC		
H	5.80	6.00	6.20
L	0.50	0.715	0.93
α	0°	4°	8°
h	0.25	0.375	0.50

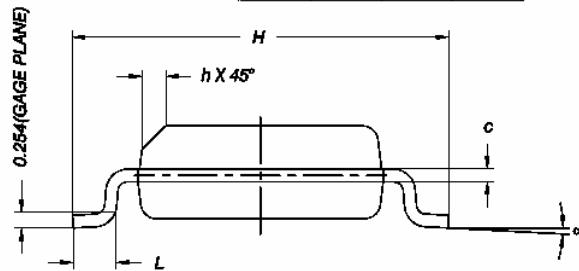
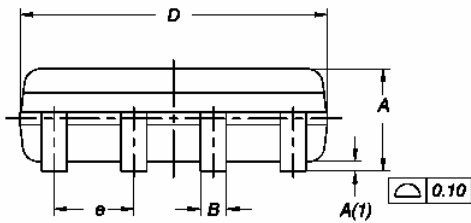

Worldwide Sales Support Locations

U.S.A

Sunnyvale Office

787 N. Mary Ave. Sunnyvale
CA 94085 U.S.A
Tel : 1-408-636-5200
Fax : 1-408-213-2450
E-Mail : americasales@magnachip.com

Chicago Office

2300 Barrington Road, Suite 330
Hoffman Estates, IL 60195 U.S.A
Tel : 1-847-882-0951
Fax : 1-847-882-0998

U.K

Knyvett House The Causeway,
Staines Middx, TW18 3BA, U.K.
Tel : +44 (0) 1784-898-8000
Fax : +44 (0) 1784-895-115
E-Mail : europesales@magnachip.com

Japan

Tokyo Office

Shinbashi 2-chome MT bldg
4F 2-5-5 Shinbashi, Minato-ku
Tokyo, 105-0004 Japan
Tel : 81-3-3595-0632
Fax : 81-3-3595-0671
E-Mail : japansales@magnachip.com

Osaka Office

3F, Shin-Osaka MT-2 Bldg
3-5-36 Miyahara Yodogawa-Ku
Osaka, 532-0003 Japan
Tel : 81-6-6394-8224
Fax : 81-6-6394-8282
E-Mail : osakasales@magnachip.com

Taiwan R.O.C

2F, No.61, Chowize Street, Nei Hu
Taipei, 114 Taiwan R.O.C
Tel : 886-2-2657-7898
Fax : 886-2-2657-8751
E-Mail : taiwansales@magnachip.com

China

Hong Kong Office

Office 03, 42/F, Office Tower Convention Plaza
1 Harbour Road, Wanchai, Hong Kong
Tel : 852-2828-9700
Fax : 852-2802-8183
E-Mail : chinasales@magnachip.com

Shenzhen Office

Room 1803, 18/F
International Chamber of Commerce Tower
Fuhua 3 Road, Futian District
ShenZhen, China
Tel : 86-755-8831-5561
Fax : 86-755-8831-5565

Shanghai Office

Ste 1902, 1 Huaihai Rd. (C) 20021
Shanghai, China
Tel : 86-21-6373-5181
Fax : 86-21-6373-6640

Korea

891, Daechi-Dong, Kangnam-Gu
Seoul, 135-738 Korea
Tel : 82-2-6903-3451
Fax : 82-2-6903-3668 ~9
Email : koreasales@magnachip.com

DISCLAIMER:

The Products are not designed for use in hostile environments, including, without limitation, aircraft, nuclear power generation, medical appliances, and devices or systems in which malfunction of any Product can reasonably be expected to result in a personal injury. Seller's customers using or selling Seller's products for use in such applications do so at their own risk and agree to fully defend and indemnify Seller.

MagnaChip reserves the right to change the specifications and circuitry without notice at any time. MagnaChip does not consider responsibility for use of any circuitry other than circuitry entirely included in a MagnaChip product. [MagnaChip](#) is a registered trademark of MagnaChip Semiconductor Ltd.

X-ON Electronics

Largest Supplier of Electrical and Electronic Components

Click to view similar products for [MOSFET](#) category:

Click to view products by [Magnachip](#) manufacturer:

Other Similar products are found below :

[614233C](#) [648584F](#) [MCH3443-TL-E](#) [MCH6422-TL-E](#) [FDPF9N50NZ](#) [FW216A-TL-2W](#) [FW231A-TL-E](#) [APT5010JVR](#) [NTNS3A92PZT5G](#)
[IRF100S201](#) [JANTX2N5237](#) [2SK2464-TL-E](#) [2SK3818-DL-E](#) [FCA20N60_F109](#) [FDZ595PZ](#) [STD6600NT4G](#) [FSS804-TL-E](#) [2SJ277-DL-E](#)
[2SK1691-DL-E](#) [2SK2545\(Q,T\)](#) [D2294UK](#) [405094E](#) [423220D](#) [MCH6646-TL-E](#) [TPCC8103,L1Q\(CM](#) [367-8430-0972-503](#) [VN1206L](#)
[424134F](#) [026935X](#) [051075F](#) [SBVS138LT1G](#) [614234A](#) [715780A](#) [NTNS3166NZT5G](#) [751625C](#) [873612G](#) [IRF7380TRHR](#)
[IPS70R2K0CEAKMA1](#) [RJK60S3DPP-E0#T2](#) [RJK60S5DPK-M0#T0](#) [APT5010JVFR](#) [APT12031JFLL](#) [APT12040JVR](#) [DMN3404LQ-7](#)
[NTE6400](#) [JANTX2N6796U](#) [JANTX2N6784U](#) [JANTXV2N5416U4](#) [SQM110N05-06L-GE3](#) [SIHF35N60E-GE3](#)