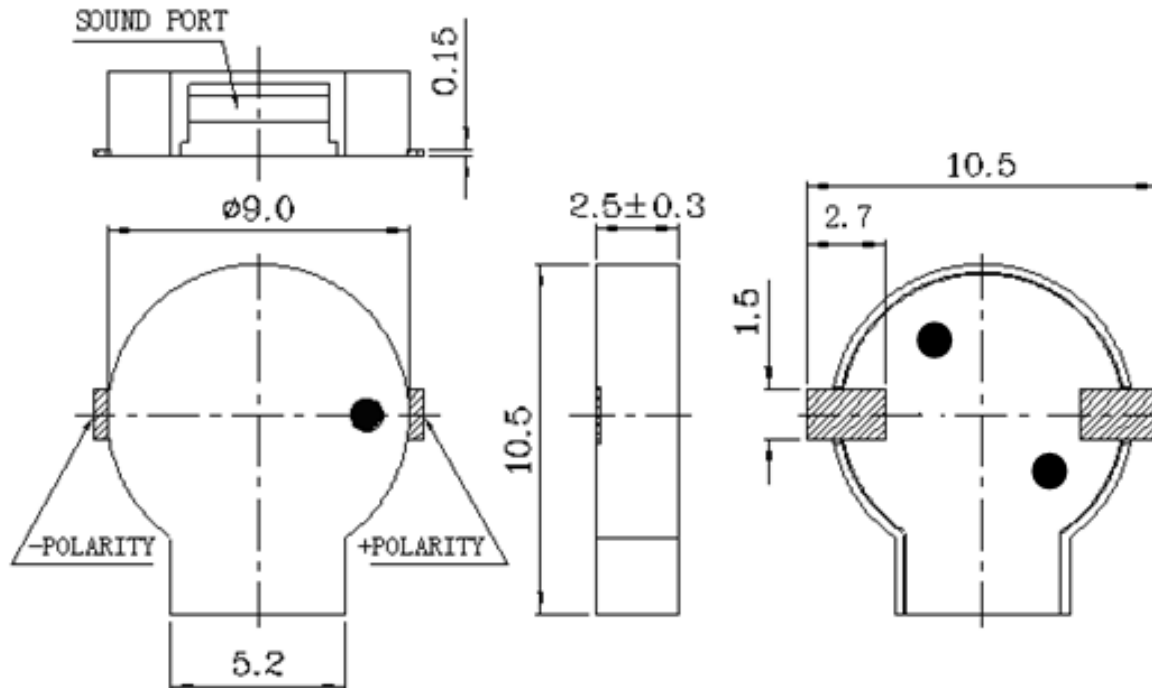

Sales Outline DrawingRevision **A****Specifications:**

Oscillation Frequency (Hz)	2700
Operating Voltage (Vp-p)	2 ~ 5
Rated Voltage (Vp-p)	3
Current Consumption Max. (mA)	90 at Rated Voltage
Sound Pressure Level (dB/min)	90 at 10cm at Rated Voltage
Coil Resistance (Ω)	16 ± 3
Operating Temperature ($^{\circ}\text{C}$)	$-30 \sim +70$
Storage Temperature ($^{\circ}\text{C}$)	$-40 \sim +85$
Type of Connection Terminal	SMD
Housing	LCP plastic resin (Color : Black)
Weight (Grams)	0.8
Condition by reflow soldering ($^{\circ}\text{C}$)	250 ± 5 / within 10 sec
Condition by hand soldering ($^{\circ}\text{C}$)	350 ± 20 / within 5 sec
Options	For other options contact factory

Dimensions: (units: mm)**RoHS Compliant****Packaging:**

Parts are supplied on cut tape.

X-ON Electronics

Largest Supplier of Electrical and Electronic Components

Click to view similar products for [Piezo Buzzers & Audio Indicators](#) category:

Click to view products by [Mallory Sonalert](#) manufacturer:

Other Similar products are found below :

[68S1240-PA](#) [ESZ-26B](#) [FDG06PSLLF](#) [FDG111PLF](#) [F/DGX12P WITH LABEL LF](#) [F/NRMB 24 BLACK LF](#) [PF-35N29WQ](#) [PFD-21A29W](#)
[PFD-27A35PQ](#) [PL-21N30WQ](#) [PLD-21N30W](#) [PLD-21N30WQ](#) [PS-531Q](#) [PT-3534FP](#) [B822B](#) [B/CP28/100DB/BLACK LF](#) [S6109](#) [SC110E](#)
[SC2036ACP](#) [SC616N-2](#) [SC628FW](#) [SC628MPG](#) [SC648D](#) [SCS045MD9DT3S](#) [ESZ-25B-5-250B](#) [ESZ-25S](#) [F/BC 35-DR LF](#) [F/EB20P-DR LF](#)
[F/SU 21-02 LF](#) [F/TCW 12 WITH LABEL LF](#) [F/UCW 03 WITH LABEL LF](#) [F/UCW 06 WITH LABEL LF](#) [PFD-27N36W](#) [PKM35-4A0](#) [PL-](#)
[35N29WQ](#) [PLD-27A35PQ](#) [PS-552Q](#) [REF-202](#) [KBS-20DA-7AS](#) [KBS-27DA-5C-105](#) [LSC628ANR](#) [PL-21N31PQ](#) [F-B-P1405ISB LF](#)
[F/DGX 05P WITH LABEL LF](#) [MSR516NP](#) [STA22702W](#) [STA20502](#) [SBM616J](#) [SBM616P](#) [SBM616PU](#)