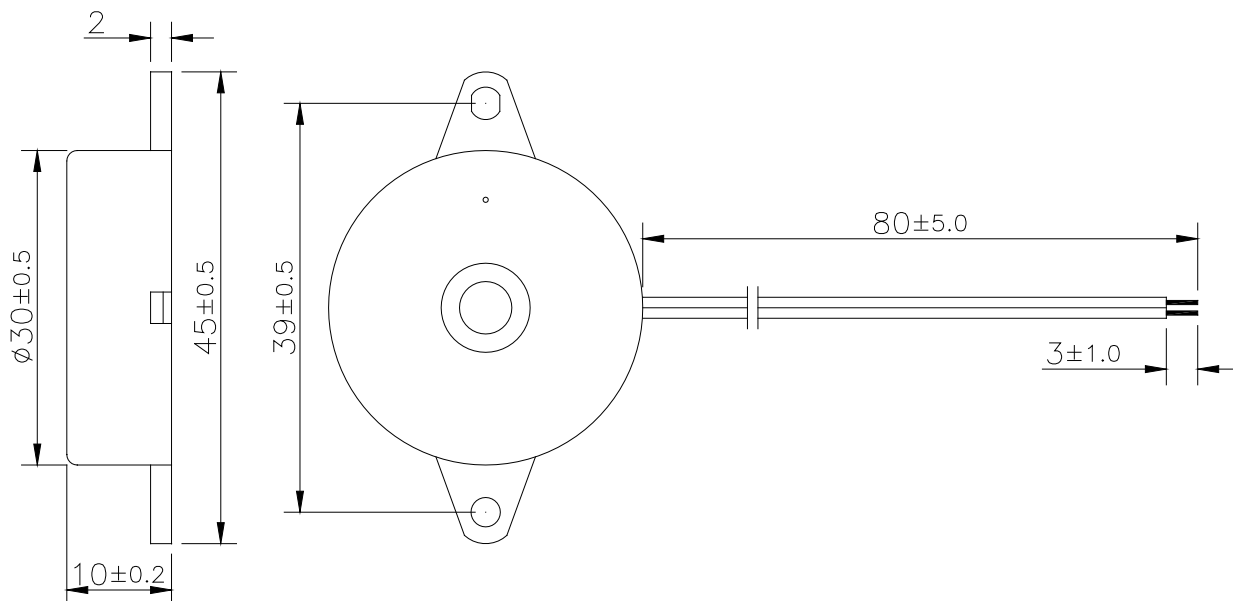

Sales Outline DrawingRevision **C**

**May not be suitable for all Medical and Aerospace applications.
Contact Mallory Sonalert to discuss your application.**

Oscillation Frequency (Hz)	3500 ± 500
Operating Voltage (Vdc)	3 ~ 28
Rated Voltage (Vdc)	12
Current Consumption (mA/max)	15 at Rated Voltage
Sound Pressure Level (dB/min)	90 at 30cm at Rated voltage
Tone/Pulse Rate	Constant
Operating Temperature (°C)	-20 ~ +70
Storage Temperature (°C)	-30 ~ +80
Housing	ABS 757 UL94HB plastic resin (Color: Black)
Lead Wires	28 AWG
Weight (Grams)	4.8
Condition by wave soldering (°C)	245 ±5 / 3±0.5 sec
Condition by hand soldering (°C)	350 ±20 / within 5 sec
Options	For other options contact factory

RoHS Compliant**Dimensions:** (units: mm)

X-ON Electronics

Largest Supplier of Electrical and Electronic Components

Click to view similar products for [Piezo Buzzers & Audio Indicators](#) category:

Click to view products by [Mallory Sonalert](#) manufacturer:

Other Similar products are found below :

[6-4](#) [68S1240-PA](#) [MBA-624](#) [FDG06PSLLF](#) [FDG111PLF](#) [F/NRMB 24 BLACK LF](#) [PF-35N29WQ](#) [PFD-21A29W](#) [PFD-27A35PQ](#) [PL-21N30WQ](#) [PL-27A35PSQ](#) [PLD-21N30W](#) [PLD-21N30WQ](#) [PS-531Q](#) [PT-3534FP](#) [EBPT-401](#) [B822B](#) [B/CP28/100DB/BLACK LF](#) [PB-1220PEQ](#) [S6109](#) [SBM616PR](#) [SC110E](#) [SC2036ACP](#) [SC616N-2](#) [SC628FW](#) [SC628MPG](#) [SC648D](#) [SCS045MD9DT3S](#) [ESZ-25B-5-250B](#) [FCM12PLF](#) [F/EB20P-DR LF](#) [F/SMD03A LF](#) [FSMD8585JSLF](#) [F/SU 21-02 LF](#) [F/TCW 12 WITH LABEL LF](#) [F/UCW 06 WITH LABEL LF](#) [PFD-27N36W](#) [PKM22EPPH40S1-B0](#) [PKM35-4A0](#) [PL-35N29WQ](#) [PS-552Q](#) [CM-5](#) [REF-202](#) [B/SE 128 RED LF](#) [KBS-20DA-7AS](#) [KBS-27DA-5C-105](#) [LSC628ANR](#) [03-810.001](#) [RTO-1R07-001](#) [PL-21N31PQ](#)