

**May not be suitable for all medical and aerospace applications.**

**Specifications: Contact Mallory Sonalert to discuss your application.**

Voice Coil Impedance ( $\Omega$ )	$8 \pm 15\%$ at 800 Hz / 1.0 V
Rated Input (W)	0.25
Max. Input (W)	0.5
Lowest Resonance Freq Fo (Hz)	$700 \pm 20\%$
Frequency Range (Hz)	Fo ~ 8000
Output S.P.L. (dB)	$89 \pm 3$ at 1W 1M .8k, 1k, 1.2k, 1.5kHz
Magnet Size (mm)	$\varnothing 9.5 * 1.5$
Magnet	Ferrite
Core Material Mylar	Black
Frame Material	Metal
Operation / Storage Temp	-25 to 50°C
Weight	5.4g
Options	For other options contact factory

**Dimensions:** (units: mm)

**ROHS Compliant**

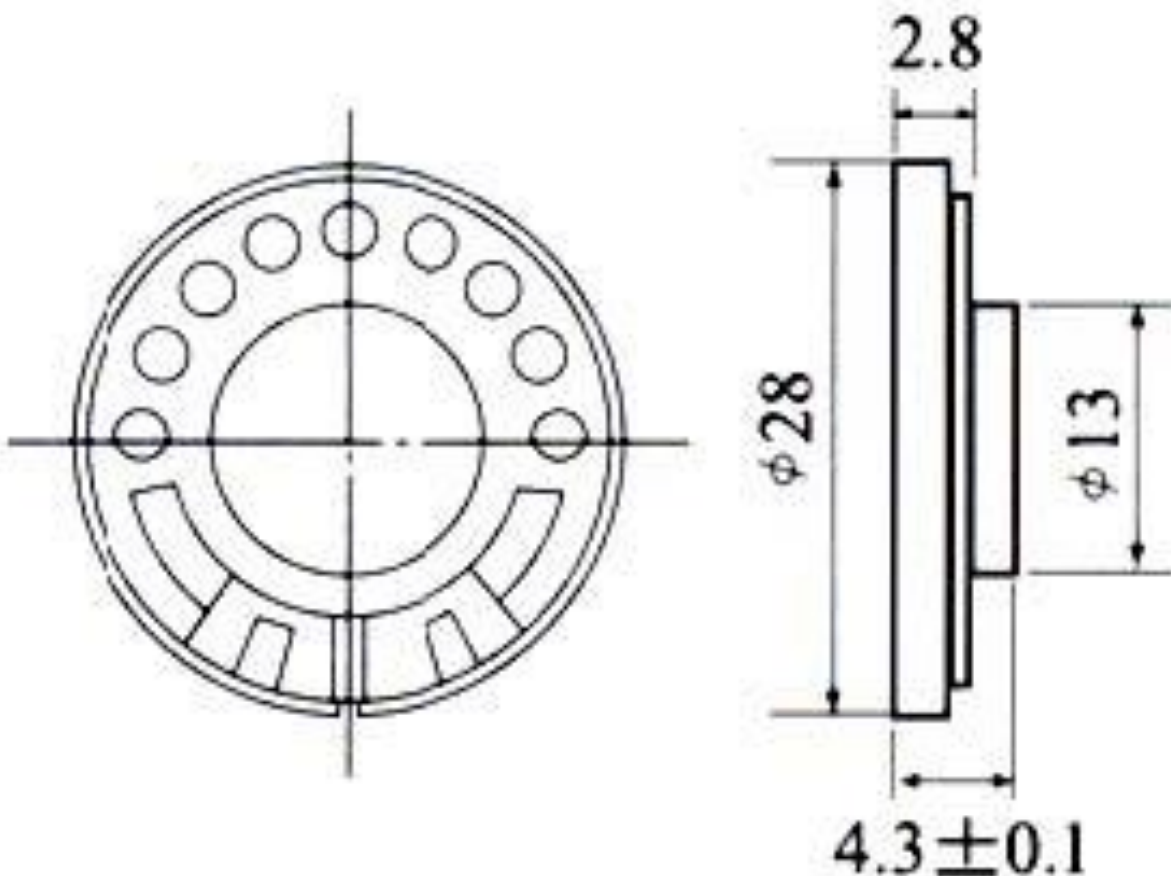

## X-ON Electronics

Largest Supplier of Electrical and Electronic Components

*Click to view similar products for [Speakers & Transducers](#) category:*

*Click to view products by [Mallory Sonalert](#) manufacturer:*

Other Similar products are found below :

[FC-30814-P127](#) [PB-1220PE](#) [PB-2015PQ](#) [900-00001](#) [AB2025B-LW50-R](#) [SWFK-31736-000](#) [PT-2065FW](#) [PT-4175W](#) [AT-2830-TW-LW35-R](#)  
[ED-30761-000](#) [CI-30120-A42](#) [SMT-0440-T-2-R](#) [PB-0927PQ](#) [BF-7083-000](#) [BF-9778-000](#) [SMS2020-08H4.5](#) [LF](#) [BDT1717-08H6.5W56MLF](#)  
[BLS50-1-08H18.2B-03](#) [LF](#) [02094](#) [02097](#) [GSPK1003PN-8R0.2W-L100](#) [GSPK151103TN-8R0.2W](#) [GSPK2014035PN-8R0.5W-L100](#)  
[FS5353DS0830-H19.3](#) [TE082703-8](#) [XMLP040BD21F](#) [24520](#) [SMT-0540-S-2-R](#) [1450069](#) [9091653](#) [9091661](#) [IPS-G6000-5](#) [9090231](#)  
[FS50MS0820-H9.7](#) [FS4014-4-2W](#) [PBM4-13.B29R.A115.0663](#) [PBM4-13.B31R.A115.0663](#) [PBM4-13.B33R.A115.0663](#) [PBM4-](#)  
[13.B35R.A115.0663](#) [A-10-6-BG360-HD1Z-GA-M4Z-ZW](#) [A-10-6-BG410-HD1Z-AA-M4Z-ZW](#) [A-10-6-BG410-HD1Z-FC-AGZ-ZW](#) [A-10-6-](#)  
[BG410-HD1Z-GA-M4Z-ZW](#) [A-10-6-BG310-HD1Z-AA-AGZ-ZW](#) [A-10-6-BG310-HD1Z-AA-M4Z-ZW](#) [A-10-6-BG310-HD1Z-GA-M4Z-ZW](#)  
[A-10-6-BG316-HD1Z-AA-AGZ-ZW](#) [A-10-6-BG316-HD1Z-AA-M4Z-ZW](#) [A-10-6-BG325-HD1Z-AA-AGZ-ZW](#) [A-10-6-BG325-HD1Z-AA-](#)  
[M4Z-ZW](#)