

# Mallory Sonalert Products, Inc.

Part #:

**SC250ER**

## Sales Outline Drawing

Revision:

**F**

### Specifications:

Sound Level Category	Soft
Mode of Operation	Continuous
Voltage Rating	60 to 250 VAC/DC
Frequency	2000 ± 500 Hz
Loudness @ 2 FT	66 to 75 dB(A) Typ.
Loudness @ Min Vdc	55/65 dB(A) @ 2 Feet and 60 Vdc
Loudness @ Max Vdc	65/78 dB(A) @ 2 Feet and 250 Vdc
Current Draw	5-16mA
Housing Material	6/6 Nylon, Color: Black
Storage Temperature	-40° to +85° C
Operating Temperature	-30° to +65° C
Panel Mounting	Recommended hole size is 1.25"(31.75mm). Thread front will fit standard 30mm(1.181") hole.
Knurled Nut	Used to attach part to panel. The max recommended torque is 10 in-lbs.
Weight (Typical)	1.6 oz (45g)
NEMA 3R,4X, & 12	Approved with use of ACC03.
Options	Please contact factory.

### Dimensions: Inches (mm)

**ROHS Compliant**

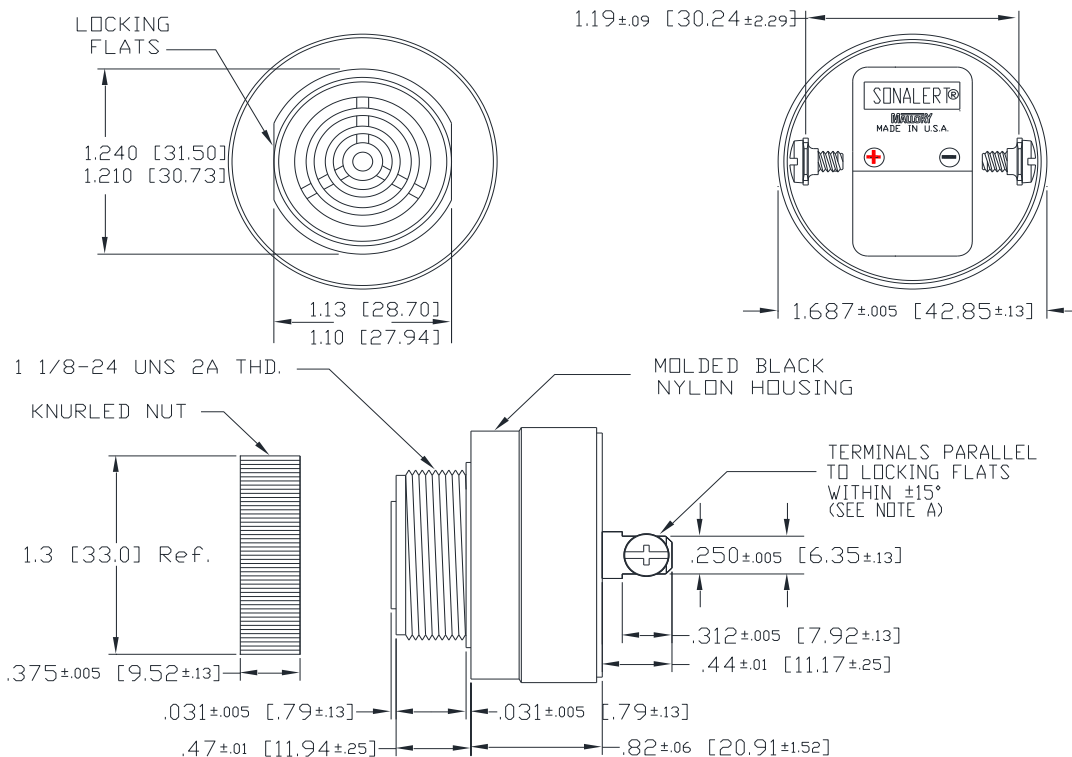

NOTE A: TERMINALS-.032 BRASS TIN PLATED, TAPPED FOR #6-32 SCREW. TWO #6-32 NICKEL PLATED BRASS SCREWS INCLUDED. WILL ACCEPT 1/4" QUICK CONNECT.

NOTE B: MOUNTING- REMOVE BLACK PLASTIC NUT AND INSERT THREADED FRONT THROUGH 1.25" HOLE PUNCHED IN PANEL, IF ORIENTATION IS NEEDED, NOTE LOCKING FLATS ON DRAWING. SCREW NUT BACK ON. DO NOT OVERTIGHTEN.

## X-ON Electronics

Largest Supplier of Electrical and Electronic Components

*Click to view similar products for [Piezo Buzzers & Audio Indicators](#) category:*

*Click to view products by [Mallory Sonalert](#) manufacturer:*

Other Similar products are found below :

[6-4](#) [68S1240-PA](#) [MBA-624](#) [FDG06PSLLF](#) [FDG111PLF](#) [F/NRMB 24 BLACK LF](#) [PF-35N29WQ](#) [PFD-21A29W](#) [PFD-27A35PQ](#) [PL-21N30WQ](#) [PL-27A35PSQ](#) [PLD-21N30W](#) [PLD-21N30WQ](#) [PS-531Q](#) [PT-3534FP](#) [EBPT-401](#) [B822B](#) [B/CP28/100DB/BLACK LF](#) [PB-1220PEQ](#) [S6109](#) [SBM616PR](#) [SC110E](#) [SC2036ACP](#) [SC616N-2](#) [SC628FW](#) [SC628MPG](#) [SC648D](#) [SCS045MD9DT3S](#) [ESZ-25B-5-250B](#) [FCM12PLF](#) [F/EB20P-DR LF](#) [F/SMD03A LF](#) [FSMD8585JSLF](#) [F/SU 21-02 LF](#) [F/TCW 12 WITH LABEL LF](#) [F/UCW 06 WITH LABEL LF](#) [PFD-27N36W](#) [PKM22EPPH40S1-B0](#) [PKM35-4A0](#) [PL-35N29WQ](#) [PS-552Q](#) [CM-5](#) [REF-202](#) [B/SE 128 RED LF](#) [KBS-20DA-7AS](#) [KBS-27DA-5C-105](#) [LSC628ANR](#) [03-810.001](#) [RTO-1R07-001](#) [PL-21N31PQ](#)