



SAMXON

ALUMINUM ELECTROLYTIC CAPACITORS

2017-2018



QC 080000



ISO 9001

ISO 14001



ACCREDITED

| | |
|------------|------------------------------------|
| 002 | Series Chart 產品體系圖 |
| 004 | Series Table 產品一覽表 |
| 006 | Application Guidelines 應用指引 |
| 015 | Part Number System 產品編碼 |
| 016 | Taping Specifications 編帶產品規格 |
| 017 | Packing Specifications 包裝規格 |
| 018 | Lead Forming Specifications 成型產品規格 |

Miniature Aluminum Electrolytic Capacitors 小型鋁電解電容器

| | |
|------------|----------------------------|
| 019 | Miniature Type 小型品 |
| 023 | General Purpose 普通品 |
| 034 | Low Impedance Type 低阻抗品 |
| 061 | High Reliability Type 高可靠品 |
| 072 | High Temperature Type 高溫度品 |
| 081 | For Audio Type 音響用品 |
| 083 | Non-polarized Type 無極性品 |
| 087 | Pen Cap Type 筆型電容 |

Large Can Aluminum Electrolytic Capacitors 大型鋁電解電容器

| | |
|------------|---|
| 093 | Lug / Snap-in Terminal Type Case Size Table 插入/自立型產品圖解 |
| 095 | Lug / Snap-in Terminal Standard Type 插入/自立型標準品 |
| 113 | Lug / Snap-in Terminal High Reliability Type 插入/自立型高可靠品 |
| 146 | Screw Terminal Type Case Size Table 螺釘型產品圖解 |
| 147 | Screw Terminal Type 螺釘型 |

V-Chip Aluminum Electrolytic Capacitors 貼片式鋁電解電容器

| | |
|------------|---|
| 178 | Surface Mount Type Packing Specifications 貼片品包裝規格 |
| 179 | Surface Mount Type 貼片品 |



Series Chart (產品體系圖)

Radial Lead Type

導針型

Index



Lug / Snap-in Terminal Type 插入/自立型



Screw Terminal Type 螺釘型



Surface Mount Type 貼片型



Series Table (產品一覽表)

| Series | Features (特點) | Letter Color | Sleeve Color | Temp. (°C) | Voltage (VDC) | Cap. (µF) | Load Life | Page |
|---|--|--------------|----------------|-----------------|---------------|--------------|----------------------|-----------------|
| Miniature Aluminum Electrolytic Capacitors | | | | | | | | 小型鋁電解電容器 |
| Miniature Type | | | | | | | | 小型品 |
| KF | 5mmL (高), +105°C | White (白) | Black (黑) | -40 ~ +105 | 4 ~ 50 | 3.3 ~ 330 | 1,000 Hrs. | P.19 |
| KS | 7mmL (高), -40°C ~ +105°C | White (白) | Black (黑) | -40 ~ +105 | 6.3 ~ 50 | 3.3 ~ 330 | 1,000 Hrs. | P.21 |
| General Purpose | | | | | | | | 普通品 |
| GS | +85°C, General (普通品) | White (白) | Dark Blue (深藍) | -40(-25) ~ +85 | 6.3 ~ 450 | 2.2 ~ 22000 | 2,000 Hrs. | P.23 |
| KM | +105°C, General (普通品) | White (白) | Black (黑) | -40(-25) ~ +105 | 6.3 ~ 450 | 0.47 ~ 33000 | 2,000 Hrs. | P.26 |
| KG | -55 ~ +105°C, Wide Temperature (寬溫度) | White (白) | Black (黑) | -55 ~ +105 | 6.3 ~ 100 | 2.2 ~ 22000 | 1,000 ~ 2,000 Hrs. | P.30 |
| OM | +105°C, Withstanding Overvoltage (耐過電壓品) | White (白) | Black (黑) | -25 ~ +105 | 200 & 400 | 22 ~ 330 | 2,000 Hrs. | P.32 |
| Low Impedance Type | | | | | | | | 低阻抗品 |
| GF | +105°C, High Ripple Current, Low Impedance (高紋波, 低阻抗) | White (白) | Sea Green (海綠) | -40 ~ +105 | 6.3 ~ 100 | 3.3 ~ 4700 | 1,000 ~ 4,000 Hrs. | P.34 |
| SF | +105°C, High Ripple Current, Long Life Assurance, Low Impedance (高紋波, 長壽命, 低阻抗) | White (白) | Black (黑) | -40 ~ +105 | 6.3 ~ 100 | 15 ~ 3900 | 3,000 ~ 6,000 Hrs. | P.38 |
| GT | +105°C, High Ripple Current, Longer Life Assurance, Low Impedance (高紋波, 較長壽命, 低阻抗) | Silver (銀) | Black (黑) | -40 ~ +105 | 6.3 ~ 100 | 15 ~ 3900 | 4,000 ~ 10,000 Hrs. | P.40 |
| GK | +105°C, Higher Ripple Current, Lower Impedance (較高紋波, 較低阻抗) | White (白) | Sea Green (海綠) | -40 ~ +105 | 6.3 ~ 25 | 100 ~ 3900 | 2,000 ~ 5,000 Hrs. | P.43 |
| SH | +105°C, Highest Ripple Current, Lowest Impedance, Long Life Assurance (更高紋波, 更低阻抗, 長壽命) | White (白) | Black (黑) | -40 ~ +105 | 6.3 ~ 50 | 100 ~ 8200 | 5,000 ~ 6,000 Hrs. | P.45 |
| SK | +105°C, Highest Ripple Current, Longest Life Assurance, Lower Impedance (更高紋波, 更長壽命, 較低阻抗) | Silver (銀) | Black (黑) | -40 ~ +105 | 6.3 ~ 100 | 33 ~ 8200 | 6,000 ~ 10,000 Hrs. | P.47 |
| RS | +105°C, High Ripple Current, Longer Life Assurance, Low Impedance (高紋波, 較長壽命, 低阻抗) | White (白) | Black (黑) | -40 ~ +105 | 6.3 ~ 100 | 15 ~ 4700 | 3,000 ~ 7,000 Hrs. | P.51 |
| GY | +105°C, Longer Life Assurance, Low Impedance (較長壽命, 低阻抗) | White (白) | Black (黑) | -40 ~ +105 | 6.3 ~ 100 | 3.3 ~ 15000 | 4,000 ~ 10,000 Hrs. | P.55 |
| RF | -55 ~ +105°C, Wide Temperature, High Ripple Current, Low Impedance (寬溫度, 高紋波, 低阻抗) | White (白) | Black (黑) | -55 ~ +105 | 6.3 ~ 100 | 22 ~ 4700 | 1,000 ~ 4,000 Hrs. | P.57 |
| High Reliability Type | | | | | | | | 高可靠品 |
| RR | Long Life Assurance, High Ripple Current (長壽命, 高紋波) | White (白) | Black (黑) | -40(-25) ~ +105 | 160 ~ 450 | 1 ~ 220 | 3,000 Hrs. | P.61 |
| RT | Long Life Assurance, High Ripple Current (長壽命, 高紋波) | White (白) | Black (黑) | -40(-25) ~ +105 | 160 ~ 450 | 1 ~ 220 | 5,000 Hrs. | P.63 |
| RE | Longer Life Assurance (較長壽命) | White (白) | Black (黑) | -25 ~ +105 | 160 ~ 450 | 1 ~ 220 | 8,000 ~ 10,000 Hrs. | P.66 |
| RD | Longer Life Assurance, High Ripple Current (較長壽命, 高紋波) | White (白) | Black (黑) | -40(-25) ~ +105 | 160 ~ 500 | 1 ~ 330 | 8,000 ~ 10,000 Hrs. | P.68 |
| RH | Longest Life Assurance, High Ripple Current (更長壽命, 高紋波) | White (白) | Black (黑) | -40(-25) ~ +105 | 160 ~ 500 | 1 ~ 220 | 10,000 ~ 12,000 Hrs. | P.70 |
| High Temperature Type | | | | | | | | 高溫品 |
| BD | +125°C, High Temperature (高溫度) | White (白) | Black (黑) | -40 ~ +125 | 10 ~ 50 | 3.3 ~ 3900 | 1,000 ~ 2,000 Hrs. | P.72 |
| RA | +130°C, High Temperature, High Ripple Current (高溫度, 高紋波) | White (白) | Black (黑) | -40(-25) ~ +130 | 10 ~ 450 | 1 ~ 4700 | 1,000 ~ 4,000 Hrs. | P.74 |
| RB | +130°C, High Temperature, High Ripple Current, Long Life Assurance (高溫度, 高紋波, 長壽命) | White (白) | Black (黑) | -40(-25) ~ +130 | 160 ~ 450 | 1.5 ~ 100 | 3,000 ~ 4,000 Hrs. | P.77 |
| RC | +130°C, High Temperature, High Ripple Current, Longer Life Assurance (高溫度, 高紋波, 較長壽命) | White (白) | Black (黑) | -25 ~ +130 | 160 ~ 450 | 1.5 ~ 100 | 5,000 ~ 6,000 Hrs. | P.79 |
| For Audio Type | | | | | | | | 音響用品 |
| FA | Standard, For Audio (標準品, 音響電容) | White (白) | Coffee (咖啡) | -40 ~ +85 | 6.3 ~ 100 | 2.2 ~ 10000 | 1,000 Hrs. | P.81 |
| Non-polarized Type | | | | | | | | 無極性品 |
| NP | +85°C, Non-polar (無極性) | Black (黑) | Green (綠) | -40 ~ +85 | 6.3 ~ 100 | 2.2 ~ 6800 | 1,000 Hrs. | P.83 |
| NH | +105°C, Non-polar (無極性) | White (白) | Black (黑) | -40 ~ +105 | 6.3 ~ 100 | 2.2 ~ 1000 | 1,000 Hrs. | P.85 |
| Pen Cap Type | | | | | | | | 筆型電容 |
| KM | +105°C, Pen Cap (筆型電容) | White (白) | Black (黑) | -25 ~ +105 | 200 ~ 450 | 22 ~ 270 | 2,000 Hrs. | P.87 |
| RW | +105°C, Pen Cap, Long Life Assurance (筆型電容, 長壽命) | White (白) | Black (黑) | -25 ~ +105 | 200 ~ 450 | 22 ~ 220 | 5,000 Hrs. | P.89 |
| RY | +105°C, Pen Cap, Longer Life Assurance (筆型電容, 較長壽命) | White (白) | Black (黑) | -25 ~ +105 | 200 ~ 450 | 22 ~ 220 | 10,000 Hrs. | P.91 |
| Large Can Aluminum Electrolytic Capacitors | | | | | | | | 大型鋁電解電容器 |
| Standard Type | | | | | | | | 標準品 |
| LP | Lug / Snap-in Terminal Type, Standard (插入/自立型, 標準品) | White (白) | Black (黑) | -40(-25) ~ +85 | 10 ~ 500 | 56 ~ 82000 | 2,000 Hrs. | P.95 |
| AP | Lug / Snap-in Terminal Type, For Audio (插入/自立型, 音響電容) | White (白) | Coffee (咖啡) | -40 ~ +85 | 16 ~ 100 | 680 ~ 10000 | 1,000 Hrs. | P.101 |
| QP | Lug / Snap-in Terminal Type, Withstanding Vibration (插入/自立型, 耐振動) | White (白) | Black (黑) | -40(-25) ~ +85 | 10 ~ 500 | 56 ~ 82000 | 2,000 Hrs. | P.103 |
| DP | Lug / Snap-in Terminal Type, Long Life Assurance, Low Impedance (插入/自立型, 長壽命, 低阻抗) | White (白) | Black (黑) | -40(-25) ~ +85 | 160 ~ 450 | 47 ~ 2200 | 5,000 Hrs. | P.109 |
| TP | Lug / Snap-in Terminal Type, Ultra Long Life Assurance (插入/自立型, 超長壽命) | White (白) | Black (黑) | -25 ~ +85 | 200 ~ 450 | 56 ~ 2200 | 10,000 Hrs. | P.111 |

Series Table (產品一覽表)

| Series | Features (特點) | Letter Color | Sleeve Color | Temp. (°C) | Voltage (VDC) | Cap. (µF) | Load Life | Page |
|---|--|--------------|--------------|-----------------|---------------|----------------|-----------------|------------------|
| Large Can Aluminum Electrolytic Capacitors | | | | | | | | 大型鋁電解電容器 |
| High Reliability Type | | | | | | | | 高可靠品 |
| HP | Lug / Snap-in Terminal Type, Wide Temperature (插入/自立型, 寬溫度) | White (白) | Black (黑) | -40(-25) ~ +105 | 10 ~ 500 | 47 ~ 56000 | 2,000 Hrs. | P.113 |
| UP | Lug / Snap-in Terminal Type, Withstanding Overvoltage (插入/自立型, 耐過電壓品) | White (白) | Black (黑) | -25 ~ +105 | 200 ~ 450 | 56 ~ 1200 | 2,000 Hrs. | P.119 |
| KP | Lug / Snap-in Terminal Type, Long Life Assurance (插入/自立型, 長壽命) | White (白) | Black (黑) | -40(-25) ~ +105 | 10 ~ 450 | 47 ~ 56000 | 3,000 Hrs. | P.121 |
| EP | Lug / Snap-in Terminal Type, Long Life Assurance (插入/自立型, 長壽命) | White (白) | Black (黑) | -40(-25) ~ +105 | 10 ~ 450 | 82 ~ 47000 | 5,000 Hrs. | P.127 |
| FP | Lug / Snap-in Terminal Type, Long Life Assurance, Low Impedance (插入/自立型, 長壽命, 低阻抗) | Silver (銀) | Black (黑) | -40(-25) ~ +105 | 10 ~ 450 | 100 ~ 33000 | 5,000 Hrs. | P.132 |
| SP | Lug / Snap-in Terminal Type, Longer Life Assurance (插入/自立型, 較長壽命) | White (白) | Black (黑) | -40(-25) ~ +105 | 160 ~ 450 | 39 ~ 2200 | 7,000 Hrs. | P.134 |
| VP | Lug / Snap-in Terminal Type, Withstanding Vibration (插入/自立型, 耐振動) | White (白) | Black (黑) | -40(-25) ~ +105 | 10 ~ 500 | 39 ~ 56000 | 2,000 Hrs. | P.137 |
| GP | Lug / Snap-in Terminal Type, Ultra Small Size (插入/自立型, 超小體積) | White (白) | Black (黑) | -40(-25) ~ +105 | 160 ~ 450 | 100 ~ 3300 | 2,000 Hrs. | P.143 |
| Screw Terminal Type | | | | | | | | 螺釘型 |
| WR | +85°C, Screw Terminal Type, Standard (螺釘型, 標準品) | Silver (銀) | Black (黑) | -40(-25) ~ +85 | 10 ~ 630 | 100 ~ 680000 | 2,000 Hrs. | P.147 |
| WI | +85°C, Screw Terminal Type, High Ripple Current (螺釘型, 高紋波) | Silver (銀) | Black (黑) | -25 ~ +85 | 350 ~ 450 | 390 ~ 22000 | 2,000 Hrs. | P.152 |
| WT | +105°C, Screw Terminal Type, Standard (螺釘型, 標準品) | Silver (銀) | Black (黑) | -40(-25) ~ +105 | 10 ~ 500 | 180 ~ 680000 | 2,000 Hrs. | P.155 |
| WX | +85°C, Screw Terminal Type, Long Life Assurance (螺釘型, 長壽命) | Silver (銀) | Black (黑) | -40(-25) ~ +85 | 10 ~ 550 | 1000 ~ 1500000 | 5,000 Hrs. | P.160 |
| WF | +105°C, Screw Terminal Type, Long Life Assurance (螺釘型, 長壽命) | Silver (銀) | Black (黑) | -40(-25) ~ +105 | 10 ~ 500 | 330 ~ 390000 | 5,000 Hrs. | P.164 |
| WH | +85°C, Screw Terminal Type, Longer Life Assurance (螺釘型, 較長壽命) | Silver (銀) | Black (黑) | -25 ~ +85 | 350 ~ 500 | 470 ~ 22000 | 10,000 Hrs. | P.169 |
| WL | +85°C, Screw Terminal Type, Ultra Long Life Assurance (螺釘型, 超長壽命) | Silver (銀) | Black (黑) | -25 ~ +85 | 350 ~ 450 | 2200 ~ 12000 | 20,000 Hrs. | P.172 |
| WB | +125°C, Screw Terminal Type, High Temperature (螺釘型, 高溫度) | Silver (銀) | Black (黑) | -25 ~ +125 | 160 ~ 400 | 330 ~ 15000 | 3,000 Hrs. | P.175 |
| V-Chip Aluminum Electrolytic Capacitors | | | | | | | | 貼片式鋁電解電容器 |
| Surface Mount Type | | | | | | | | 貼片品 |
| VS1 | +85°C, Surface Mount Type, General Purpose (貼片普通品) | | | -40 ~ +85 | 6.3 ~ 50 | 0.1 ~ 1500 | 2,000 Hrs. | P.179 |
| VT1 | +105°C, Surface Mount Type, General Purpose, 1,000 Hours (貼片普通品) | | | -55 ~ +105 | 6.3 ~ 50 | 0.1 ~ 220 | 1,000 Hrs. | P.181 |
| VTD | +105°C, Surface Mount Type, General Purpose, 2,000 Hours (貼片普通品) | | | -55 ~ +105 | 25 ~ 100 | 4.7 ~ 1500 | 2,000 Hrs. | P.183 |
| VTG | +105°C, Surface Mount Type, High Voltage, 3,000 Hours (高壓貼片品) | | | -25 ~ +105 | 400 | 2.2 ~ 4.7 | 3,000 Hrs. | P.185 |
| VZ2 | +105°C, Surface Mount Type, Low Impedance (低阻抗貼片品) | | | -55 ~ +105 | 6.3 ~ 100 | 1 ~ 1500 | 2,000 Hrs. | P.187 |
| VTL | +105°C, Surface Mount Type, Long Life, 3,000/5,000 Hours (長壽命貼片品) | | | -40 ~ +105 | 10 ~ 50 | 0.1 ~ 1000 | 3,000/5,000Hrs. | P.189 |



Application Guidelines (應用指引)

1. Circuit Design

- 1.1 Please make sure the environment and mounting conditions to which the capacitor will be exposed are within the conditions specified in this catalog (or alternate SAMXON'S specifications, such as series drawings).
- 1.2 Operating temperature and applied ripple current must be within SAMXON'S specification.
 - The capacitor must not be used in an ambient temperature which exceeds the operating temperature specified in this catalog.
 - Do not apply excessive current which exceeds the allowable ripple current.
- 1.3 Appropriate capacitors which comply with the life requirement of the products should be selected when designing the circuit.
- 1.4 Aluminum electrolytic capacitors are polarized. Do not apply reverse voltage or AC voltage. Please use non-polar capacitors for a circuit that can possibly see reversed polarity. Note: Even non-polar capacitors cannot be used for AC voltage application.
- 1.5 Do not use aluminum electrolytic capacitors in a circuit that requires rapid and very frequent charge/discharge. In this type of circuit, it is necessary to use a special design capacitor with extended life characteristics.
- 1.6 Do not apply excess voltage.
 - Please pay attention so that the peak voltage, which is DC voltage overlapped by ripple current, will not exceed the rated voltage.
 - In the case where more than 2 aluminum electrolytic capacitors are used in series , please make sure that applied voltage will be lower than rated voltage and the voltage will be applied to each capacitor equally using a balancing resistor in parallel with the capacitor.
- 1.7 Outer sleeve of the capacitor is not guaranteed as an electrical insulator.
 - Do not use a standard sleeve on a capacitor in applications that require the electrical insulation. When the application requires special insulation, please contact our sales office for details.
 - Do not connect the blank terminal (reinforcing terminal) of a multi-terminal (three- or four-terminal) product of the snap-in type to another circuit it may cause a short circuit.
- 1.8 Capacitors must not be used under the following conditions:
 - Capacitors must not be exposed to water (including condensation), brine or oil.
 - Ambient conditions that include toxic gases such as hydrogen sulfide, sulfurous acid, nitrous acid, chlorine, ammonium, etc.
 - Ambient conditions that expose the capacitor to ozone, ultraviolet ray and radiation.
 - Severe vibration and physical shock conditions that exceed SAMXON'S specifications.
- 1.9 When designing a circuit board, please pay attention to following:
 - Make the hole spacing on the P.C. board match the lead spacing of the capacitor.
 - There should not be any circuit pattern or circuit wire above the capacitor safety vent.
 - Unless otherwise specified, following clearance should be mad above the safely vent.

| Case Diameter | Gap Required |
|---------------|--------------|
| Φ6.3~16 | 2mm or more |
| Φ18~35 | 3mm or more |
| Φ40 or more | 5mm or more |

- In case the vent side is placed toward P.C. board (such as end seal vented parts), make a corresponding hole on the P.C. board to release the gas when vent is operated. The hole should be made to match the capacitor vent position.
- Do not install screw terminal capacitor with end seal side down. When you install a screw terminal capacitor in a horizontal mount, the positive terminal must be in the upper position.

- 1.10 The main chemical solution of the electrolyte and the separator paper used in the capacitors are combustible. The electrolyte is conductive. When it comes in contact with the P.C. board, there is a possibility of pattern corrosion or short circuit between the circuit pattern which could in result of smoking or catching fire. Do not locate any circuit pattern beneath the capacitor end seal.
- 1.11 Do not design a circuit board so that heat generating components such as resistor and transistors are placed near an aluminum capacitor or reverse side of P.C. board (under the capacitor).
- 1.12 Electrical characteristics may vary depending on changes in temperature and frequency. Please consider this variation when you design circuits.
- 1.13 When you are designing capacitors for use on double-sided P.C. boards, do not place capacitors on circuit patterns or over the unused holes.
- 1.14 The torque for terminal screw or brackets screws must be within the specified value on SAMXON's drawings.
- 1.15 When you install more than 2 capacitors in parallel, consider the balance of current flowing into the capacitors.

2. Mounting

- 2.1 Once a capacitor has been assembled in the set and power applied, do not attempt to reuse the capacitor in other circuits or application.
- 2.2 Electric potential between positive and negative terminal may exist as a result or returned electromotive force, so please discharge the capacitor using a 1k Ω resistor.
- 2.3 Leakage current of the parts that have been stored for more than 6 months may increase. When leakage current has increased, please perform a voltage treatment using 1k Ω resistor.
- 2.4 Please confirm ratings before installing capacitors on the P.C. board.
- 2.5 Please confirm polarity before installing capacitors on the P.C. board.
- 2.6 Do not drop capacitors on the floor, nor use a capacitor that was dropped.
- 2.7 Be careful not to deform the capacitor during installation.
- 2.8 Please confirm that the lead spacing of the capacitor matches the hole spacing of the P.C. board prior to installation.
- 2.9 Snap-in can type capacitor such as JIS configuration 692, 693, 694 and 695 type should be installed tightly to the P.C. board (allow no gap between the P.C. board and bottom of the capacitor).
- 2.10 Please pay attention that the clinch force is not too strong when capacitors are placed and fixed by an automatic insertion machine.



Application Guidelines (應用指引)

- 2.11 Please pay attention to that the mechanical shock to the capacitor by suction nozzle of the automatic insertion machine or automatic mounter, or by product checker, or by centering mechanism.
- 2.12 Soldering condition must be confirmed to be within SAMXON'S specification.
- Pb/Sn Type
Flow Soldering: $235 \pm 5^{\circ}\text{C}$ ≤ 10 sec.
Hand Soldering (Soldering iron tip): $350 \pm 10^{\circ}\text{C}$ ≤ 3 sec.
 - Pb-free Type
Flow Soldering: $260 \pm 5^{\circ}\text{C}$ ≤ 10 sec.
Hand Soldering (Soldering iron tip): $400 \pm 10^{\circ}\text{C}$ ≤ 3 sec.
- 2.13 Do not tilt lay down or twist the capacitor body after the capacitor are soldered to the P.C. board.
- 2.14 Do not carry the P.C. board by grasping the soldered capacitor.
- 2.15 Please do not allow anything to touch the capacitor after soldering. If P.C. board are stored in stack, please make sure P.C. board or the other components do not touch the capacitor. The capacitors shall not be effected by any radiated heat from the soldered P.C. board or other components after soldering.
- 2.16 Do not clean capacitors with halogenated cleaning agent.
- 2.17 Precautions on fixing materials and coating materials.
- Do not use any ingredients which contain halogen.
 - Please pay attention to remove flux and any contamination which remains in the gap between the end seal and P.C. board and dry that portion well before coating.
 - Please do not apply any material all around the capacitor body but apply it partially.
 - Please contact our sales office to make sure whether the curing condition of coating material would cause any problems.
- 2.18 Do not install screw terminal capacitor with end seal side down. When you install a screw terminal capacitor in a horizontal position, the positive terminal must be in the upper position.

3. Storage

- 3.1 The characteristics of aluminum electrolytic capacitors degrade when stored in a static condition for long period of time. The rate of deterioration depends upon temperature and humidity.
- 3.2 Capacitors should be stored at the temperature of 5°C to 35°C , the humidity of less than 75% RH and out of direct sunlight.
- 3.3 Capacitors that have been stored for long periods normally over one year should be subjected to a "voltage aging" treatment before use. This will reform and repair the oxide dielectric.
- 3.4 Suggested aging procedure is gradually applying the rated voltage to the capacitor(s) for 30 to 60 minutes. If the capacitance still exceeds the specified leakage current value, please do not use it.

4. Disposal

- 4.1 Dispose of capacitors as industrial waste.
- 4.2 Consignment to the waste disposal specialists to handle it professionally.

The above mentioned material according to EIAJ RCR-2367B (issued in March, 2002), titled "Guideline of notabilia for aluminum electrolytic capacitors for use in electronic equipment". Please refer to the book for details.

5. Printed Circuit Board Cleaning

5.1 Foreword

It had been generally accepted that halogen type organic solvents were hazardous to aluminum electrolytic capacitors. This is because an organic solvent can permeate the capacitor through the end seal. Then, the solvent dissolves and free chlorine ion (Cl⁻ion), which can corrode the aluminum electrodes. The following measures were previously the only way to avoid this phenomenon.

- Use of cleaning agents, not hazardous to capacitors such as water or alcohol.
- Mount capacitors on PC boards cleaned with a halogen type solvent beforehand.
- Use of epoxy end seals

These measures have disadvantages with respect to working efficiency, cleaning capability, cost etc. Therefore, aluminum electrolytic capacitors which can withstand halogen type cleaning agents are desirable.

5.2 Types of Cleaning Agents

Generally there are three types of cleaning agents.

- Water type
- Alcohol type
- Halogen type

Of these, water and alcohol will have little effect even if they permeate the capacitor. However, halogens can cause corrosion of aluminum foil and tab. Common types of halogen cleaning agents are listed in Table below:

| Chemical Name | Structural Formula | Representative Brand Name |
|--------------------------|---|---------------------------|
| Trichlorotrifluoroethane | C ₂ Cl ₃ F ₃ | Freon TF, Daiflon S-3 |
| Fluorotrichloromethane | CCl ₃ F | Freon-11, Daiflon S-1 |
| Trichloroethane | C ₂ H ₃ Cl ₃ | Chloroethene |
| Trichloroethylene | C ₂ HCl ₃ | Trichlene |
| Methyl Chloride | CH ₃ Cl | MC |

The last four solvents listed above are particularly corrosive to aluminum and are not recommended to use as cleaning solvents.

5.3 Penetration Channel of Solvent and Corrosion Mechanism

The three channels by which solvents can penetrate into the capacitor are illustrated:

- ① Penetration through a clearance between the rubber and the aluminum case (curled section)
- ② Penetration through a clearance between the rubber and the lead wires
- ③ Permeation through the rubber end seal



To reduce the possibility of solvents entering a capacitor, tight sealing is required to eliminate clearances between the rubber and the aluminum case/lead wires. A solvent resistant rubber material is also a necessity.

When a solvent, for example, trichlorotrifluoroethane gets inside a non anti-solvent capacitor, the chlorine ion is free as shown by the following reaction formula.

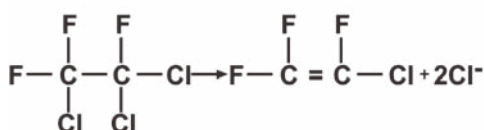

This chlorine ion reacts with aluminum as follows:



Then AlCl₃ resolves in water, and it becomes:



Thus, the Cl⁻ion is free again and repeats the corrosion of aluminum. The degree of this reaction depends on the volume of solvent, the ambient temperature of the capacitor in service, the applied voltage and time etc.



Application Guidelines (應用指引)

6. Basic Electrical Characteristics Capacitance:

The capacitance of capacitor is determined as AC capacitance by measuring its impedance. As the AC capacitance depends on frequency, voltage and other measuring methods, JIS C 5102 prescribes that the series capacitive component of an equivalent series circuit (○—R—L—C—○) shall be considered as the capacitance by measuring it at a frequency of 120Hz and a maximum AC voltage of 0.5Vrms with a DC bias voltage of 1.5 to 2.0V applied for aluminum electrolytic capacitors.

The capacitance of an aluminum electrolytic capacitor shows smaller values as a measuring frequency increases. See the typical behavior shown as right chart.



Measuring temperature as well as frequency effects the capacitance. As the measuring temperature decreases, the capacitance shows smaller values. See the typical behavior shown as right chart.



On one hand, DC capacitance, which can be determined by measuring the charge when a DC voltage is applied, shows a slightly larger value than the AC capacitance at a normal temperature and has the flatter characteristic over the temperature range.

Tan δ (tangent of loss angle or dissipation factor):

The tan δ is the ratio of the resistive component (ESR) to the capacitive reactance (1/ωC) in the equivalent series circuit, and its measuring conditions are the same as the capacitance.



The tan δ show higher values as a measuring frequency increases and a measuring temperature decreases, as follows:

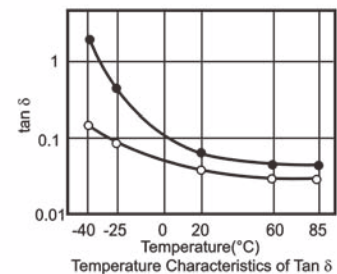

Equivalent Series Resistance (ESR)

The ESR is comprised of the resistance due to aluminum oxide layer and electrolyte/separator combination and other resistance effected with foil length, foil surface area, etc.

The ESR value depends on the temperature. Decreasing the temperature makes the resistivity of the electrolyte increase with the result of the ESR increasing.

As the measuring frequency increases, the ESR decreases and reaches an almost constant value that is mainly the frequency-independent resistance due to electrolyte/separator combination.

Impedance (Z):

The impedance is the resistance which oppose the flow of alternating current at a specific frequency. It is related to capacitance (C) and inductance (L) in terms of capacitive and inductive reactance, and also related to the ESR. It is expressed as follows:

As shown as right chart, the capacitive reactance (Xc) predominates at the range of low frequencies, and the impedance decreases with increasing frequency until it reaches the ESR in the middle frequency range. At the range of the higher frequencies the inductive reactance (Xl) comes to predominate, so that the impedance increases with increasing the measuring frequency.

As shown as right chart, the impedance value varies with temperature, because the resistance of the electrolyte strongly changes with temperature.

$$Z = \sqrt{ESR^2 + (X_L - X_C)^2}$$

Where: $X_C = 1/\omega C = 1/2\pi fC$
 $X_L = \omega L = 2\pi fL$

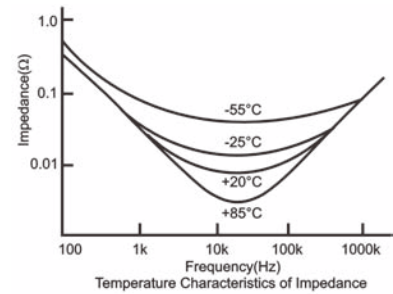

Temperature Characteristics of Impedance



Leakage Current vs Time



Typical Temperature Characteristics

Leakage Current:

The dielectric of a capacitor has a very high resistance which prevents the flow of DC current. However, due to the characteristics of the aluminum oxide layer that functions as a dielectric in contact with electrolyte, a small amount of current, called leakage current, will flow to reform and repair the oxide layer while a voltage is being applied. As shown below, a high leakage current flows in the first minutes as a voltage is applied to the capacitor, and then the leakage current will decrease and reach an almost steady-state value with time.

Measuring temperature and voltage effect the leakage current. The leakage current shows higher values as the temperature and voltage increase.

In general, the leakage current is measured at 20°C by applying the rated voltage, which is applied through a resistor of 1,000Ω connected in series with the capacitor, and several minutes after the capacitor reached the rated voltage. The catalog prescribes the measuring temperature and time.

LIFE ESTIMATION CHART





Application Guidelines (應用指引)

7. Quality Policy

7.1 General

Our basic corporate goals and commitment to total quality are set down in our quality policy. The quality of our products and services is an essential part of our corporate strategy, whose paramount aim is total customer satisfaction. Consistent application of quality management system results in flawless products and a high level of user benefit from our components. Our quality management system always reflects the most stringent international standards.

Our corporate goals is to play a leading role among the world's most competitive companies in electronic components. All quality management measures are geared to optimum customer benefit.

They include:

- Mastery of processes
- Continuous improvement programs to narrow process tolerances, and to increase quality and yield.
- Enhanced productivity
- Continuous optimization of material, capital and human resources.
- Promotion of innovation
- Putting customer benefit first in every product we design. Determining customer needs in partnership with customers, and rapid implementation of agreements.

The SAMXON quality management system, which is documented in the new edition of the company-wide SAMXON Quality Management Handbook, is designed to support this strategy.

7.2 Quality assurance

The required measures and regulations for quality assurance are documented in instructions on operations and procedures; the effectiveness and adequacy of the QA system are regularly checked in internal audits.

7.3 Quality programs

Project-oriented improvement programs pursuing the strategic objective of zero defects are set up and conducted by specialist teams.

7.4 Process assurance

Assurance of production processes starts as early as the planning and development phase. Quality tools like FMEA and SVP help detect and avoid potential errors, and safeguard process capability and product quality. Documentation of all production and testing steps as well as training of personnel are essential to flawless production. Statistical process control (SPC) is used wherever applicable. Permanent availability of plant is ensured by preventive maintenance.

7.5 Incoming inspection

Raw materials, parts and consumable undergo incoming inspection appropriate to their significance in the end product, unless this responsibility has been transferred to the supplier under a quality assurance agreement or similar.

7.6 In-process inspection

Wherever possible, in-process inspection is conducted to certify the conformity not only of intermediate products, but also of process supervision and control (e.g. SPC). It is generally integrated into the process steps and designed to be as preventive as possible, i.e. to avoid errors.

7.7 Final inspection/approval for shipment

Final inspection verifies the major properties of the end products batch by batch, usually by means of fully automated selection tests.

Approval for shipment helps certify that products shipped comply with specifications. It includes:

- Testing of principal parameter,
- Identification check and visual assessment,
- Examination of papers accompanying the batch.

8. Manufacturing and quality assurance procedures for Al electrolytic capacitors

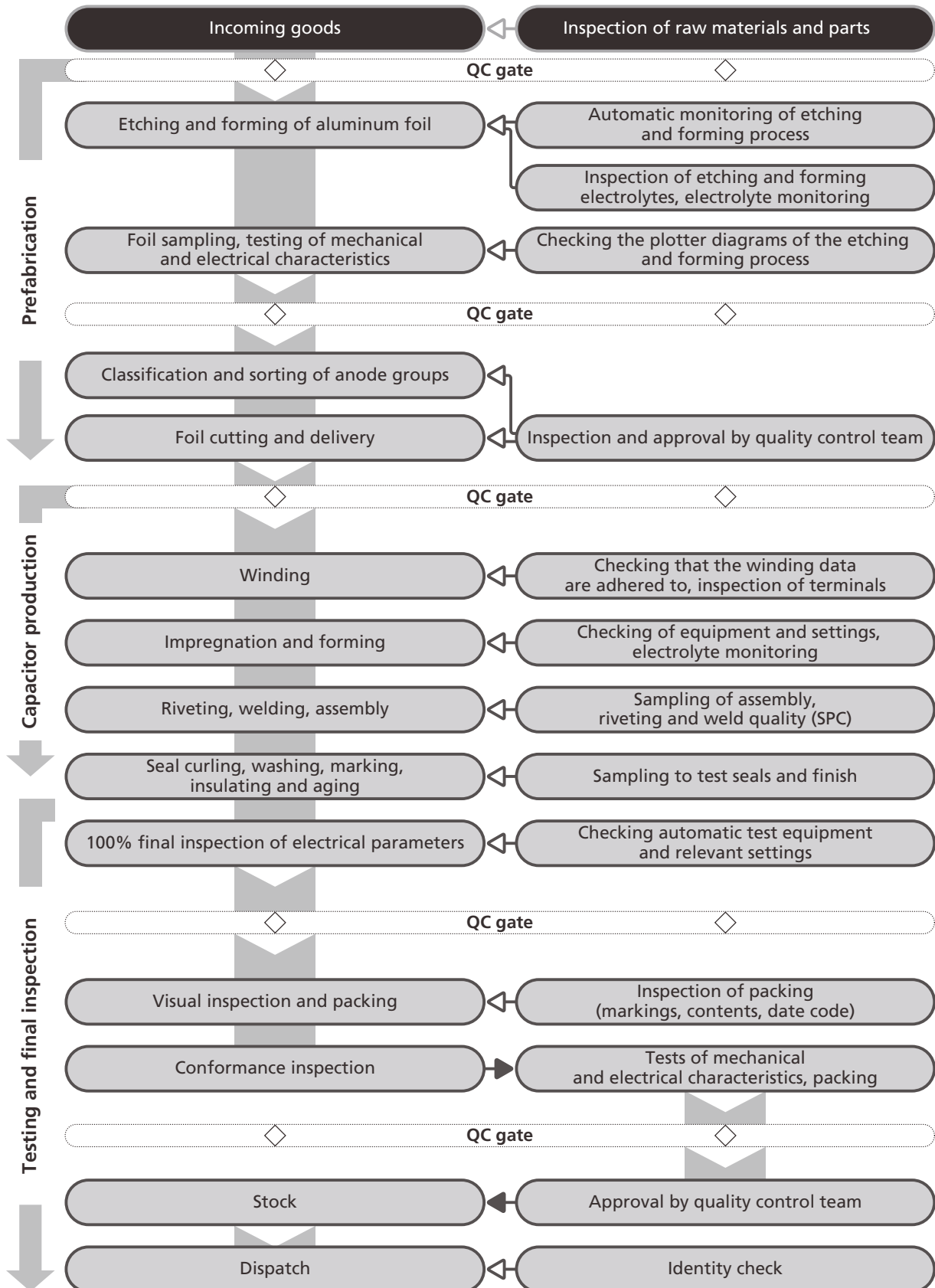



Application Guidelines (應用指引)

9. Environmental

Environmental policy

Our fundamental commitment to protection of the environment is laid down in SAMXON environmental policy:

- We work continuously to lighten the burden on the environment and to reduce consumption of energy and resources beyond statutory requirements.
- We take all precautions to avoid environmental hazards and to prevent damage to the environment.
- Potential impact on the environment is assessed and flows into product and process planning at the earliest possible stage.
- Our environmental management system ensures that our environmental policy is effectively implemented. The technical and organizational procedures required are regularly monitored and constantly upgraded.
- Every employee is required to act in an environmentally conscious manner. It is a permanent task of management to promote awareness of responsibility for the environment at all levels.
- We seek to influence our business associates to follow environmental guidelines similar to ours. We supply our customers with information on environmentally friendly use of our products. We work in a spirit of cooperation with the authorities.
- We inform the public of the environmental impact of our activities and the environmental achievements of our company.

10. Compliance with RoHS Directive

The company is committed to compliance with the European Union Restriction of Hazardous Substance (RoHS) Directive. We hereby guarantee that our products do not contain following materials exceeding the RoHS Directive (2011/65/EU).

- | | |
|---|----------|
| ■ Lead (Pb) and its compounds | ≤1000ppm |
| ■ Mercury (Hg) and its compounds | ≤1000ppm |
| ■ Cadmium (Cd) and its compounds | ≤100ppm |
| ■ Hexavalent chromium, Cr ⁶⁺ , Cr VI | ≤1000ppm |
| ■ Polybrominated biphenyls, PBBs | ≤1000ppm |
| ■ Polybrominated diphenyls, PBDEs | ≤1000ppm |

11. Halogen Free Compliant

The products identified in the catalogue, and their homogeneous subcomponents, do not contain any of the following substances in concentrations greater than the listed maximum limits.

| Substance | Maximum Limit (ppm) |
|---|---------------------|
| Bromine (Br) | 900 ppm (0.09%) |
| Chlorine (Cl) | 900 ppm (0.09%) |
| Total concentration of Chlorine (Cl) + Bromine (Br) | 1500 ppm (0.15%) |

Part Number System (產品編碼)

| 1 2 3 | | | 4 5 6 | | | 7 | | 8 9 | | 10 11 12 | | | 13 14 | | 15 16 | | 17 | |
|--------|----------|------|-------------|------|------------|-----------|-------------|---------|-----------------|-------------|--|--|-------|--|---------------------|--|-----------------|--|
| EGS | | | 105 | | | M | | 1H | | D11 | | | TC | | SA | | P | |
| SERIES | | | CAPACITANCE | | | TOLERANCE | | VOLTAGE | | CASE SIZE | | | TYPE | | SAMXON PRODUCT LINE | | SLEEVE MATERIAL | |
| Series | Cap (uF) | Code | Tol. (%) | Code | Vol. (W.V) | Code | Case Size | | Feature | Code | SAMXON Product Line | | | | | | | |
| EKF | 0.1 | 104 | ±5 | J | 2 | 0D | Diameter(Φ) | Code | Radial bulk | RR | For internal use only (The product lines we have H,A,B,C,D,E,M or 0,1,2,3,4,5,9). | | | | | | | |
| EKS | | | | | 3 | B | Ammo Taping | | | | | | | | | | | |
| EGS | 0.22 | 224 | ±10 | K | 2.5 | 0E | | 3.5 | 1 | 2.0mm Pitch | TT | | | | | | | |
| EKM | | | | | 4 | 0G | 5 | D | | | | | | | | | | |
| EKG | 0.33 | 334 | ±15 | L | 6.3 | 0J | 6.3 | E | 2.5mm Pitch | TU | | | | | | | | |
| EOM | | | | | 8 | 0K | 8 | F | | | | | | | | | | |
| EGF | 0.47 | 474 | ±20 | M | 10 | 1A | 10 | G | 3.5mm Pitch | TV | | | | | | | | |
| ESF | | | | | 12.5 | 1B | 12.5 | I | | | | | | | | | | |
| EGT | 1 | 105 | ±30 | N | 16 | 1C | 13 | J | 5.0mm Pitch | TC | | | | | | | | |
| EGK | | | | | 20 | 1D | 13.5 | V | | | | | | | | | | |
| ESK | 2.2 | 225 | -40 | W | 25 | 1E | 14 | 4 | Lead Cut & Form | CB-Type | CB | | | | | | | |
| ESH | | | | | 30 | 1I | 14.5 | A | | | | | | | | | | |
| ESK | 3.3 | 335 | -20 | A | 32 | 13 | 16 | K | CB-Type | CE-Type | CE | | | | | | | |
| ERS | | | | | 35 | 1V | 16.5 | 7 | | | | | | | | | | |
| EGY | 4.7 | 475 | -20 | C | 40 | 1G | 18 | L | HE-Type | HE-Type | HE | | | | | | | |
| ERF | | | | | 42 | 1M | 18.5 | 8 | | | | | | | | | | |
| ERR | 10 | 106 | +10 | X | 50 | 1H | 20 | M | KD-Type | KD-Type | KD | | | | | | | |
| ERT | | | | | 57 | 1L | 22 | N | | | | | | | | | | |
| ERE | 22 | 226 | -20 | S | 63 | 1J | 25 | O | FD-Type | FD-Type | FD | | | | | | | |
| ERD | | | | | 71 | 1S | 30 | P | | | | | | | | | | |
| ERH | 33 | 336 | +50 | B | 75 | 1T | 34 | W | EH-Type | EH-Type | EH | | | | | | | |
| EBD | | | | | 80 | 1K | 35 | 8 | | | | | | | | | | |
| ERA | 47 | 476 | -10 | V | 85 | 1R | 40 | R | PCB Terminal | Snap-in | SW | | | | | | | |
| ERB | | | | | 90 | 19 | 42 | 4 | | | | | | | | | | |
| ERC | 100 | 107 | 0 | Q | 90 | 19 | 45 | 6 | Snap-in | SX | | | | | | | | |
| EFA | | | | | 100 | 2A | 51 | S | | | | | | | | | | |
| ENP | 220 | 227 | -10 | T | 120 | 2O | 63.5 | T | Lug | SG | | | | | | | | |
| ENH | | | | | 125 | 2B | 76 | U | | | | | | | | | | |
| ERW | 330 | 337 | +30 | E | 150 | 2Z | 80 | 8 | Screw | O5 | | | | | | | | |
| ERY | | | | | 160 | 2C | 80 | X | | | | | | | | | | |
| ELP | 470 | 477 | -10 | F | 180 | 2P | 90 | 8 | Screw | O6 | | | | | | | | |
| EAP | | | | | 200 | 2D | 90 | X | | | | | | | | | | |
| EQP | 2200 | 228 | +50 | T | 200 | 2D | 100 | Z | Screw | O6 | | | | | | | | |
| EDP | | | | | 215 | 22 | 102 | T2 | | | | | | | | | | |
| ETP | 22000 | 229 | +13 | E | 215 | 22 | 10.2 | T2 | Screw | T5 | | | | | | | | |
| EHP | | | | | 220 | 2N | 11 | 11 | | | | | | | | | | |
| EUP | 33000 | 339 | +50 | G | 220 | 2N | 11.5 | 1A | Screw | T6 | | | | | | | | |
| EKP | | | | | 230 | 23 | 12 | 12 | | | | | | | | | | |
| EPK | 22000 | 229 | -5 | F | 250 | 2E | 12.5 | 1B | Screw | D5 | | | | | | | | |
| EEP | | | | | 275 | 2T | 13 | 13 | | | | | | | | | | |
| EFP | 33000 | 339 | +15 | R | 300 | 2I | 13.5 | 1C | Screw | D6 | | | | | | | | |
| ESP | | | | | 310 | 2R | 20 | 20 | | | | | | | | | | |
| EVP | 47000 | 479 | 0 | O | 315 | 2F | 25 | 25 | Screw | D6 | | | | | | | | |
| EWR | | | | | 330 | 2U | 29.5 | 2J | | | | | | | | | | |
| EWI | 100000 | 10T | +20 | I | 350 | 2V | 30 | 30 | Screw | D6 | | | | | | | | |
| EWT | | | | | 330 | 2U | 31.5 | 3A | | | | | | | | | | |
| EWX | 150000 | 15T | 0 | Z | 375 | 2Q | 35 | 35 | Screw | D6 | | | | | | | | |
| EWY | | | | | 385 | 2Y | 35.5 | 3E | | | | | | | | | | |
| EWZ | 220000 | 22T | +30 | H | 400 | 2G | 50 | 50 | Screw | D6 | | | | | | | | |
| EVH | | | | | 420 | 2M | 80 | 80 | | | | | | | | | | |
| EWL | 330000 | 33T | +5 | D | 450 | 2W | 100 | 1L | Screw | D6 | | | | | | | | |
| EWB | | | | | 420 | 2M | 105 | 1K | | | | | | | | | | |
| VS1 | 1000000 | 10M | +15 | H | 500 | 2H | 110 | 1M | Screw | D6 | | | | | | | | |
| VT1 | | | | | 450 | 2W | 120 | 1N | | | | | | | | | | |
| VTD | 1500000 | 15M | +5 | D | 600 | 26 | 130 | 1P | Screw | D6 | | | | | | | | |
| VTG | | | | | 500 | 2H | 140 | 1Q | | | | | | | | | | |
| VZ2 | 2200000 | 22M | +20 | H | 550 | 25 | 150 | 1R | Screw | D6 | | | | | | | | |
| VTL | | | | | 600 | 26 | 155 | 1E | | | | | | | | | | |
| | 3300000 | 33M | +10 | H | 630 | 2J | 160 | 1S | Screw | D6 | | | | | | | | |
| | | | | | 630 | 2J | 165 | 1F | | | | | | | | | | |
| | | | +50 | H | | | 170 | 1T | Screw | D6 | | | | | | | | |
| | | | | | 170 | 1T | | | | | | | | | | | | |
| | | | | | | | 180 | 1U | Screw | D6 | | | | | | | | |
| | | | | | | | 180 | 1U | | | | | | | | | | |
| | | | | | | | 190 | 1V | Screw | D6 | | | | | | | | |
| | | | | | | | 190 | 1V | | | | | | | | | | |
| | | | | | | | 200 | 2L | Screw | D6 | | | | | | | | |
| | | | | | | | 200 | 2L | | | | | | | | | | |
| | | | | | | | 215 | 2A | Screw | D6 | | | | | | | | |
| | | | | | | | 215 | 2A | | | | | | | | | | |
| | | | | | | | 210 | 2M | Screw | D6 | | | | | | | | |
| | | | | | | | 210 | 2M | | | | | | | | | | |
| | | | | | | | 220 | 2N | Screw | D6 | | | | | | | | |
| | | | | | | | 220 | 2N | | | | | | | | | | |
| | | | | | | | 240 | 2Q | Screw | D6 | | | | | | | | |
| | | | | | | | 240 | 2Q | | | | | | | | | | |
| | | | | | | | 250 | 2R | Screw | D6 | | | | | | | | |
| | | | | | | | 250 | 2R | | | | | | | | | | |
| | | | | | | | 260 | 2S | Screw | D6 | | | | | | | | |
| | | | | | | | 260 | 2S | | | | | | | | | | |
| | | | | | | | 270 | 2T | Screw | D6 | | | | | | | | |
| | | | | | | | 270 | 2T | | | | | | | | | | |

Taping Specifications (編帶產品規格)



Fig-1



Fig-2



Fig-3



Fig-4

SPECIFICATIONS

| Item | Reference figure | Dimensions (mm) | | | | | | | | | | | | Tol. | |
|--|------------------|-----------------|-------|--------|-------|--------|---------|--------|---------|-----------|--------|--------|-------|---------|---------------|
| | | Fig 1 | | | Fig 2 | | | Fig 3 | | Fig 4 | | | | | |
| Diameter | D | 3 | 4 ~ 5 | 5 | 6.3 | 8 | 10 | 12.5 | 16, 18 | 4, 5, 6.3 | 5, 6.3 | 8 | | | |
| Height | A | 5 | 5 ~ 7 | 9 ~ 15 | 5 ~ 7 | 9 ~ 15 | 11 ~ 20 | 9 ~ 21 | 15 ~ 35 | 15 ~ 40 | 5 ~ 7 | 9 ~ 15 | 5 ~ 9 | 11 ~ 20 | |
| Lead Diameter | d | 0.4 | 0.45 | 0.5 | 0.45 | 0.5 | 0.5 | 0.6 | 0.6 | 0.8 | 0.45 | 0.5 | 0.45 | 0.5 | ±0.05 |
| Component Spacing | P | 12.7 | | | 12.7 | 12.7 | 12.7 | 12.7 | 15 | 30 | 12.7 | | 12.7 | | ±1.0 |
| Pitch of sprocket holes | P ₀ | 12.7 | | | 12.7 | 12.7 | 12.7 | 12.7 | 15 | 15 | 12.7 | | 12.7 | | ±0.2 |
| Distance between centres of component leads | F | 2.5 | | | 2.5 | 3.5 | 5.0 | 5.0 | 7.5 | 7.5 | 5.0 | | 5.0 | | ±0.5 ±0.8 |
| Carrier tape width | W | 18.0 | | | 18.0 | 18.0 | 18.0 | 18.0 | 18.0 | 18.0 | 18.0 | | 18.0 | | ±0.5 |
| Distance between the center of upper edge of carrier tape and sprocket holes | W ₁ | 9.0 | | | 9.0 | 9.0 | 9.0 | 9.0 | 9.0 | 9.0 | 9.0 | | 9.0 | | ±0.5 |
| Distance between the abscissa and the bottom of the components body | H | 18.5 | | | 18.5 | 18.5 | 18.5 | 18.5 | 18.5 | 18.5 | 17.5 | 18.5 | 17.5 | 20.0 | ±0.75 ±0.5 |
| Distance between the abscissa and the reference plane of the components with crimped leads | H ₀ | - | | | - | - | - | - | - | - | 16.0 | | 16.0 | | ±0.5 |
| Hold down tape width | W ₀ | 7.0 | | | 7.0 | 7.0 | 7.0 | 7.0 | 12 | 12 | 7.0 | | 7.0 | | Min. |
| Max. lateral deviation of the component body vertical to the tape plane | Δh | 0 | | | 0 | 0 | 0 | 0 | 0 | 0 | 0 | | 0 | | ±1.0 |
| Distance between the upper edges of the carrier tape and the hold down tape | W ₂ | 0 ~ 3 | | | 0 ~ 3 | 0 ~ 3 | 0 ~ 3 | 0 ~ 3 | 0 ~ 3 | 0 ~ 3 | 0 ~ 3 | | 0 ~ 3 | | - |
| Distance between center of terminal and the sprocket holes | P ₁ | 5.1 | | | 5.1 | 4.6 | 3.85 | 5.0 | 3.75 | 3.75 | 3.85 | | 3.85 | | ±0.5 |
| Distance between center of the component and sprocket holes | P ₂ | 6.35 | | | 6.35 | 6.35 | 6.35 | 6.35 | 7.5 | 7.5 | 6.35 | | 6.35 | | ±1.0 |

Packing Specifications (包裝規格)



PACKING QUANTITY (TAPING TYPE)

| ΦD x L (mm) | L (mm) | W (mm) | H (mm) | Inner Box Quantity | Outer Box Quantity |
|--------------|--------|--------|--------|--------------------|--------------------|
| 3 x 5 | 330 | 229 | 51 | 3,000 | 30,000 |
| 4 x 5 ~ 7 | 330 | 229 | 51 | 2,500 | 25,000 |
| 5 x 5 ~ 11 | 330 | 229 | 51 | 2,000 | 20,000 |
| 6.3 x 5 ~ 12 | 330 | 229 | 51 | 1,500 | 15,000 |
| 8 x 5 ~ 12 | 330 | 229 | 51 | 1,000 | 10,000 |
| 8 x 14 ~ 20 | 330 | 229 | 64 | 1,000 | 8,000 |
| 10 x 12.5 | 330 | 191 | 51 | 500 | 5,000 |
| 10 x 16 | 330 | 191 | 56 | 500 | 5,000 |
| 10 x 20 ~ 25 | 323 | 191 | 64 | 500 | 4,000 |
| 10 x 30 | 330 | 191 | 69 | 500 | 4,000 |
| 12.5 x 20 | 325 | 267 | 58 | 500 | 2,000 |
| 12.5 x 25 | 325 | 270 | 63 | 500 | 2,000 |
| 12.5 x 35 | 325 | 270 | 74 | 500 | 2,000 |
| 16 x 25 | 315 | 221 | 63 | 250 | 1,000 |
| 16 x 30 ~ 35 | 315 | 221 | 76 | 250 | 1,500 |
| 18 x 20 ~ 25 | 343 | 275 | 63 | 250 | 1,000 |
| 18 x 30 ~ 35 | 343 | 275 | 73 | 250 | 500 |
| 18 x 40 | 343 | 275 | 73 | 250 | 500 |

PACKING QUANTITY (BULK TYPE)

| Long Lead Wire Product | | | | | |
|------------------------|----------------------|--------------------|--------------------|--------------------|--------------------|
| ΦD x L (mm) | Plastic Bag Quantity | Inner Box Quantity | Outer Box Quantity | Inner Box Quantity | Outer Box Quantity |
| 3 x 5 | 1,000 | 24,000 | 96,000 | | |
| 4 x 5 | 1,000 | 16,000 | 64,000 | | |
| 4 x 7 | 1,000 | 14,000 | 56,000 | | |
| 5 x 5 | 1,000 | 12,000 | 48,000 | | |
| 5 x 7 | 1,000 | 10,000 | 40,000 | | |
| 5 x 11 | 1,000 | 8,000 | 32,000 | | |
| 6.3 x 5 ~ 7 | 1,000 | 8,000 | 32,000 | | |
| 6.3 x 11 | 1,000 | 6,000 | 24,000 | | |
| 8 x 5 ~ 7 | 1,000 | 6,000 | 24,000 | | |
| 8 x 9 | 500 | 4,000 | 16,000 | | |
| 8 x 10 ~ 16 | 500 | 3,000 | 12,000 | | |
| 8 x 20 | 200 | 1,600 | 6,400 | | |
| 8 x 25 | 200 | 1,200 | 4,800 | | |
| 10 x 12.5 | 400 | 2,400 | 9,600 | | |
| 10 x 15 ~ 20 | 200 | 1,200 | 7,200 | | |
| 10 x 25 ~ 30 | 200 | 1,200 | 4,800 | | |
| 12.5 x 20 | 150 | 1,200 | 4,800 | | |
| 12.5 x 25 | 150 | 900 | 3,600 | | |
| 12.5 x 30 ~ 35 | 100 | 600 | 2,400 | | |
| 12.5 x 40 | - | 300 | 1,800 | | |
| 16 x 20 | - | 200 | 2,000 | | |
| 16 x 25 ~ 30 | - | 200 | 1,600 | | |
| 16 x 35 ~ 40 | - | 200 | 1,200 | | |
| 18 x 15 ~ 20 | - | 150 | 1,500 | | |
| 18 x 25 ~ 30 | - | 150 | 1,200 | | |
| 18 x 35 ~ 50 | - | 150 | 900 | | |

PACKING QUANTITY (SNAP-IN)

| Snap-in Terminal Product | | | | | |
|--------------------------|--------------------|--------------------|--------------|--------------------|--------------------|
| ΦD x L (mm) | Inner Box Quantity | Outer Box Quantity | ΦD x L (mm) | Inner Box Quantity | Outer Box Quantity |
| 20 x 25 | 100 | 1,200 | 25 x 30 ~ 35 | 100 | 800 |
| 20 x 30 ~ 40 | 100 | 1,000 | 25 x 40 ~ 50 | 100 | 600 |
| 22 x 25 | 100 | 1,200 | 30 x 30 ~ 35 | 50 | 500 |
| 22 x 30 ~ 40 | 100 | 1,000 | 30 x 40 ~ 50 | 50 | 400 |
| 22 x 45 ~ 50 | 100 | 800 | 35 x 30 ~ 35 | 40 | 400 |
| 25 x 25 | 100 | 1,000 | 35 x 40 ~ 50 | 40 | 320 |

Lead Forming Specifications (成型產品規格)

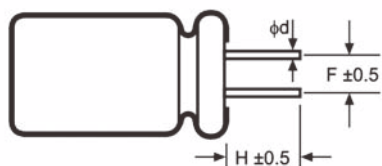

TYPE CB

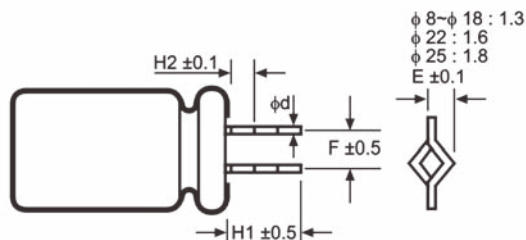

TYPE KD

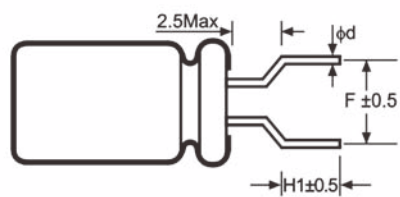

TYPE HE

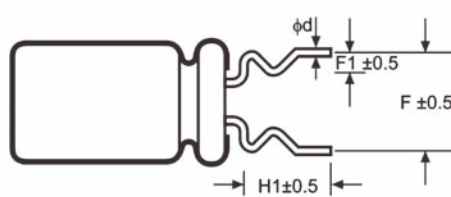

TYPE EC

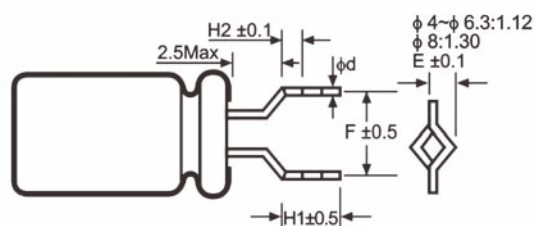

TYPE FD

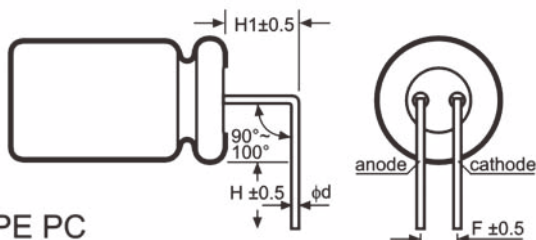

TYPE PC

| SHAPE CODE | ϕD | 4 | 5 | 6.3 | 8 (L > 5mm) | 10 | 13 | 16 | 18 |
|------------|-------------------|------|------|------|-------------|------|------|------|------|
| CB | F | 1.5 | 2.0 | 2.5 | 3.5 | 5.0 | 5.0 | 7.5 | 7.5 |
| | H | 3.5 | 3.5 | 3.5 | 3.5 | 3.5 | 3.5 | 3.5 | 3.5 |
| | $\phi d \pm 0.05$ | 0.45 | 0.5 | 0.5 | 0.5 | 0.6 | 0.6 | 0.8 | 0.8 |
| HE | F | 5.0 | 5.0 | 5.0 | 5.0 | - | - | - | - |
| | H1 | 5.0 | 5.0 | 5.0 | 5.0 | - | - | - | - |
| | $\phi d \pm 0.05$ | 0.45 | 0.5 | 0.5 | 0.5 | - | - | - | - |
| FD | F | 5.0 | 5.0 | 5.0 | 5.0 | - | - | - | - |
| | H1 | 4.5 | 4.5 | 4.5 | 4.5 | - | - | - | - |
| | H2 | 1.8 | 1.8 | 1.8 | 1.8 | - | - | - | - |
| | $\phi d \pm 0.05$ | 0.45 | 0.5 | 0.5 | 0.5 | - | - | - | - |
| KD | E | 1.12 | 1.12 | 1.12 | 1.30 | - | - | - | - |
| | F | - | - | - | - | 5.0 | 5.0 | 7.5 | 7.5 |
| | H1 | - | - | - | - | 4.5 | 4.5 | 4.5 | 4.5 |
| | H2 | - | - | - | - | 2.0 | 2.0 | 2.0 | 2.0 |
| | $\phi d \pm 0.05$ | - | - | - | - | 0.6 | 0.6 | 0.8 | 0.8 |
| EC | E | - | - | - | - | 1.30 | 1.30 | 1.30 | 1.30 |
| | F | 5.0 | 5.0 | 5.0 | 5.0 | - | - | - | - |
| | F1 | 1.2 | 1.2 | 1.2 | 1.2 | - | - | - | - |
| | H1 | 4.0 | 4.0 | 4.0 | 4.0 | - | - | - | - |
| PC | $\phi d \pm 0.05$ | 0.45 | 0.5 | 0.5 | 0.5 | - | - | - | - |
| | F | - | 2.0 | 2.5 | 3.5 | 5.0 | 5.0 | 7.5 | 7.5 |
| | H | - | 4.0 | 4.0 | 4.0 | 4.0 | 4.0 | 4.0 | 4.0 |
| | H1 | - | 3.0 | 3.0 | 3.0 | 3.0 | 3.0 | 3.0 | 3.0 |
| | $\phi d \pm 0.05$ | - | 0.5 | 0.5 | 0.5 | 0.6 | 0.6 | 0.8 | 0.8 |

FEATURES

- Super miniature, 5mmL, high temperature, suitable for use in electronic circuit of high density assembly of video recorder, remote controller, VCD etc.

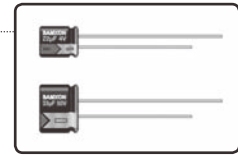

SPECIFICATIONS

| Item | Performance Characteristics | | | | | | | |
|---------------------------------|--|---|------|------|---|------|------|------|
| Operating Temperature Range | -40 to +105°C | | | | | | | |
| Rated Working Voltage Range | 4 to 50V | | | | | | | |
| Nominal Capacitance Range | 3.3 to 330μF | | | | | | | |
| Capacitance Tolerance | ±20% at 120Hz, +20°C | | | | | | | |
| Leakage Current | I ≤ 0.01CV or 3 (μA) whichever is greater measured after 2 minutes application of rated working voltage at +20°C | | | | | | | |
| tan δ (120Hz, +20°C) | Working Voltage (V) | 4 | 6.3 | 10 | 16 | 25 | 35 | 50 |
| | tan δ (max.) | 0.37 | 0.28 | 0.24 | 0.20 | 0.16 | 0.13 | 0.12 |
| Low Temperature Characteristics | Impedance ratio max. at 120Hz | | | | | | | |
| | Working Voltage (V) | 4 | 6.3 | 10 | 16 | 25 | 35 | 50 |
| | Z-25°C / Z+20°C | 6 | 3 | 3 | 2 | 2 | 2 | 2 |
| | Z-40°C / Z+20°C | 12 | 8 | 5 | 4 | 3 | 3 | 3 |
| High Temperature Loading | Test time | : 1,000 hours | | | Post test requirements at +20°C | | | |
| | Test temperature | : +105°C | | | Leakage current : ≤ initial specified value | | | |
| | Test conditions | : Rated DC working voltage with rated ripple current | | | Cap. change : within ±20% of the initial measured value (4V: within ±30%) | | | |
| | | | | | tan δ : ≤ 200% of the initial specified value | | | |
| Shelf Life | At +105°C no voltage applied after 1,000 hours and then being stabilized at +20°C the capacitors shall meet the following limits | | | | | | | |
| | Leakage current | : ≤ initial specified value | | | | | | |
| | Cap. change | : within ±20% of the initial measured value (4V: within ±30%) | | | | | | |
| | tan δ | : ≤ 200% of the initial specified value | | | | | | |
| Industrial Standard | JIS C - 5101-4 (IEC 60384-4) | | | | | | | |

CASE SIZE TABLE

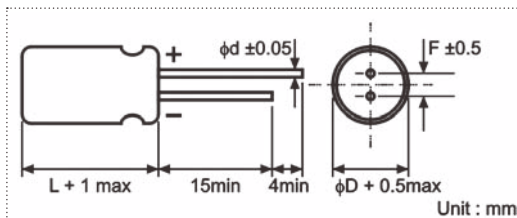

| | | | | |
|----|------|-----|-----|-----|
| φD | 4 | 5 | 6.3 | 8 |
| F | 1.5 | 2.0 | 2.5 | 2.5 |
| φd | 0.45 | | | |

RIPPLE CURRENT MULTIPLIER

Frequency Coefficient

| Coefficient | Cap (μF) | 50 | 120 | 300 | 1k | 10k~ |
|-------------|----------|------|------|------|------|------|
| ≤47 | | 0.75 | 1.00 | 1.35 | 1.57 | 2.00 |
| 68~330 | | 0.80 | 1.00 | 1.23 | 1.34 | 1.50 |

PART NUMBER SYSTEM (EXAMPLE : 16V 33μF)

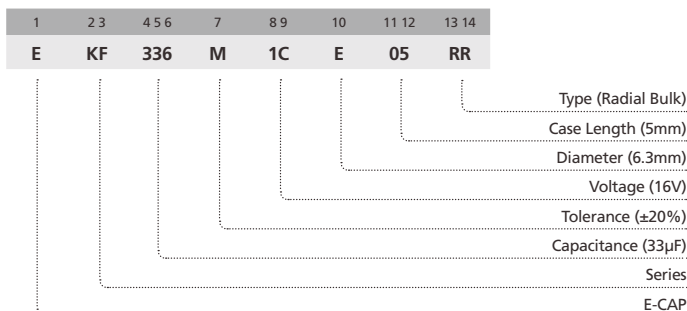

STANDARD RATINGS

| Voltage (Code) | | 4V (0G) | | 6.3V (0J) | | 10V (1A) | | 16V (1C) | |
|----------------|------|-----------|----------------|-----------|----------------|-----------|----------------|-----------|----------------|
| Cap. (μF) | Code | Case Size | Ripple Current | Case Size | Ripple Current | Case Size | Ripple Current | Case Size | Ripple Current |
| 10 | 106 | | | | | | | 4 x 5 | 18 |
| 22 | 226 | 4 x 5 | 22 | 4 x 5 | 22 | 4 x 5 | 24 | 5 x 5 | 30 |
| 33 | 336 | 5 x 5 | 30 | 5 x 5 | 30 | 5 x 5 | 35 | 6.3 x 5 | 40 |
| 47 | 476 | 5 x 5 | 36 | 5 x 5 | 36 | 6.3 x 5 | 46 | 6.3 x 5 | 50 |
| 100 | 107 | 6.3 x 5 | 60 | 6.3 x 5 | 60 | 6.3 x 5 | 67 | 6.3 x 5 | 73 |
| 220 | 227 | | | 8 x 5 | 103 | 8 x 5 | 116 | 8 x 5 | 126 |
| 330 | 337 | | | 8 x 5 | 127 | | | | |

Maximum Allowable Ripple Current (mArms) at 105°C 120Hz

Case Size ΦD x L (mm)

| Voltage (Code) | | 25V (1E) | | 35V (1V) | | 50V (1H) | |
|----------------|------|-----------|----------------|-----------|----------------|-----------|----------------|
| Cap. (μF) | Code | Case Size | Ripple Current | Case Size | Ripple Current | Case Size | Ripple Current |
| 3.3 | 335 | | | 4 x 5 | 11 | 4 x 5 | 14 |
| 4.7 | 475 | 4 x 5 | 13 | 4 x 5 | 15 | 5 x 5 | 19 |
| 10 | 106 | 4 x 5 | 20 | 5 x 5 | 25 | 6.3 x 5 | 30 |
| 22 | 226 | 6.3 x 5 | 38 | 6.3 x 5 | 48 | 8 x 5 | 52 |
| 33 | 336 | 6.3 x 5 | 48 | 6.3 x 5 | 59 | 8 x 5 | 63 |
| 47 | 476 | 6.3 x 5 | 58 | 8 x 5 | 82 | | |
| 100 | 107 | 8 x 5 | 97 | | | | |

Maximum Allowable Ripple Current (mArms) at 105°C 120Hz

Case Size ΦD x L (mm)

Specifications are subject to change without notice. Should a safety or technical concern arise regarding the product, please be sure to contact our sales offices or agents immediately.

FEATURES

- Rated working voltage range 6.3 to 50V DC operation temperature range -40 to +105°C.
- This series is for communication equipments, switching power supply, industrial measuring instruments, automotive electric products, etc.

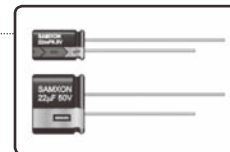

SPECIFICATIONS

| Item | Performance Characteristics | | | | | | | |
|---------------------------------|--|--|------|------|---|------|------|--|
| Operating Temperature Range | -40 to +105°C | | | | | | | |
| Rated Working Voltage Range | 6.3 to 50V | | | | | | | |
| Nominal Capacitance Range | 3.3 to 330μF | | | | | | | |
| Capacitance Tolerance | ±20% at 120Hz, +20°C | | | | | | | |
| Leakage Current | I ≤ 0.01CV or 3 (μA) whichever is greater measured after 2 minutes application of rated working voltage at +20°C | | | | | | | |
| tan δ (120Hz, +20°C) | Working Voltage (V) | 6.3 | 10 | 16 | 25 | 35 | 50 | |
| | tan δ (max.) | 0.24 | 0.21 | 0.18 | 0.15 | 0.13 | 0.12 | |
| Low Temperature Characteristics | Impedance ratio max. at 120Hz | | | | | | | |
| | Working Voltage (V) | 6.3 | 10 | 16 | 25 | 35 | 50 | |
| | Z-25°C / Z+20°C | 4 | 2 | 2 | 2 | 2 | 2 | |
| | Z-40°C / Z+20°C | 8 | 5 | 4 | 3 | 3 | 3 | |
| High Temperature Loading | Test time | : 1,000 hours | | | Post test requirements at +20°C | | | |
| | Test temperature | : +105°C | | | Leakage current : ≤ Initial specified value | | | |
| | Test conditions | : Rated DC working voltage with rated ripple current | | | Cap. change : within ±20% of the initial measured value | | | |
| | | | | | tan δ : ≤ 200% of the initial specified value | | | |
| Shelf Life | At +105°C no voltage applied after 1,000 hours and then being stabilized at +20°C the capacitors shall meet the following limits | | | | | | | |
| | Leakage current | : ≤ Initial specified value | | | | | | |
| | Cap. change | : within ±20% of the initial measured value | | | | | | |
| | tan δ | : ≤ 200% of the initial specified value | | | | | | |
| Industrial Standard | JIS C - 5101-4 (IEC 60384-4) | | | | | | | |

CASE SIZE TABLE

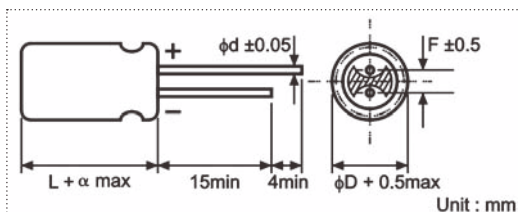

| | | | | |
|----|-----------|-----|-------------|-----|
| ΦD | 4 | 5 | 6.3 | 8 |
| F | 1.5 | 2.0 | 2.5 | 3.5 |
| Φd | 0.45 | | | |
| α | (L ≤ 7) 1 | | (L ≥ 9) 1.5 | |

RIPPLE CURRENT MULTIPLIER

Frequency Coefficient

| Coefficient | Cap (μF) | 50 | 120 | 300 | 1k | 10k~ |
|-------------|----------|------|------|------|------|------|
| ≤47 | | 0.75 | 1.00 | 1.35 | 1.57 | 2.00 |
| 68~220 | | 0.80 | 1.00 | 1.23 | 1.34 | 1.50 |

PART NUMBER SYSTEM (EXAMPLE : 6.3V 47μF)

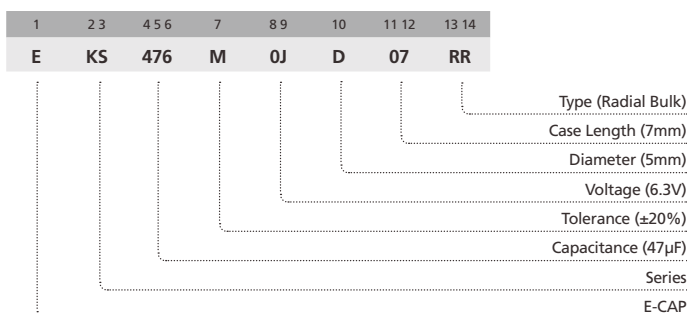

STANDARD RATINGS

| Voltage (Code) | | 6.3V (0J) | | 10V (1A) | | 16V (1C) | | 25V (1E) | |
|----------------|------|-----------|----------------|-----------|----------------|-----------|----------------|-----------|----------------|
| Cap. (μF) | Code | Case Size | Ripple Current | Case Size | Ripple Current | Case Size | Ripple Current | Case Size | Ripple Current |
| 10 | 106 | | | | | 4 x 7 | 29 | 4 x 7 | 29 |
| 22 | 226 | 4 x 7 | 34 | 4 x 7 | 34 | 4 x 7 | 38 | 5 x 7 | 45 |
| 33 | 336 | 4 x 7 | 37 | 4 x 7 | 40 | 5 x 7 | 50 | 5 x 7 | 55 |
| 47 | 476 | 4 x 7 | 44 | 5 x 7 | 50 | 5 x 7 | 60 | 6.3 x 7 | 67 |
| 100 | 107 | 5 x 7 | 67 | 5 x 7 | 72 | 6.3 x 7 | 92 | 6.3 x 7 | 97 |
| | | | | 6.3 x 7 | 83 | 8 x 7 | 106 | 8 x 7 | 113 |
| 220 | 227 | 6.3 x 7 | 112 | 8 x 7 | 140 | 8 x 9 | 174 | | |
| 330 | 337 | 8 x 7 | 158 | | | | | | |

Maximum Allowable Ripple Current (mArms) at 105°C 120Hz

Case Size ΦD x L (mm)

| Voltage (Code) | | 35V (1V) | | 50V (1H) | |
|----------------|------|-----------|----------------|-----------|----------------|
| Cap. (μF) | Code | Case Size | Ripple Current | Case Size | Ripple Current |
| 3.3 | 335 | | | 4 x 7 | 24 |
| 4.7 | 475 | 4 x 7 | 24 | 5 x 7 | 29 |
| 10 | 106 | 5 x 7 | 36 | 5 x 7 | 38 |
| | | | | 6.3 x 7 | 44 |
| 22 | 226 | 6.3 x 7 | 57 | 8 x 7 | 65 |
| 33 | 336 | 6.3 x 7 | 62 | | |
| 47 | 476 | 6.3 x 7 | 74 | | |
| 100 | 107 | 8 x 9 | 65 | | |

Maximum Allowable Ripple Current (mArms) at 105°C 120Hz

Case Size ΦD x L (mm)

Specifications are subject to change without notice. Should a safety or technical concern arise regarding the product, please be sure to contact our sales offices or agents immediately.

FEATURES

- High CV value, guarantee 2,000 hours load life at 85°C.
- Suitable for use in electronic circuits in colour TV receiver, video recorder etc.



SPECIFICATIONS

| Item | Performance Characteristics | |
|---------------------------------|---|--|
| Operating Temperature Range | -40 to +85°C | -25 to +85°C |
| Rated Working Voltage Range | 6.3 to 100V | 160 to 450V |
| Nominal Capacitance Range | 2.2 to 22000µF | |
| Capacitance Tolerance | ±20% at 120Hz, +20°C | |
| Leakage Current | I ≤ 0.01CV or 3 (µA) whichever is greater measured after 2 minutes application of rated working voltage at +20°C | |
| tan δ (120Hz, +20°C) | Working Voltage (V) | I ≤ 0.03CV + 40 (µA) after 2 minutes application of rated working voltage at +20°C |
| | tan δ (max.) | |
| | Working Voltage (V) | |
| | tan δ (max.) | |
| Low Temperature Characteristics | For capacitance value >1000µF, add 0.02 per another 1000µF | |
| | Impedance ratio max. at 120Hz | |
| | Working Voltage (V) | |
| | Z-25°C / Z+20°C | |
| | Z-40°C / Z+20°C | |
| | Working Voltage (V) | |
| High Temperature Loading | For capacitance value >1000µF, add 0.5 per another 1000µF for Z-25°C / Z+20°C add 1.0 per another 1000µF for Z-40°C / Z+20°C | |
| | Test time : 2,000 hours | Post test requirements at +20°C |
| | Test temperature : +85°C | Leakage current : ≤ Initial specified value |
| Shelf Life | Test conditions : Rated DC working voltage with rated ripple current | Cap. change : within ±20% of the initial measured value |
| | | tan δ : ≤ 200% of the initial specified value |
| Industrial Standard | JIS C - 5101-4 (IEC 60384-4) | |

CASE SIZE TABLE



| φD | 8 (L < 20) | 8 (L ≥ 20) | 10 | 12.5 | 16 | 18 | 22 | 25 |
|----|--------------|------------|-----|------|--------------|-----|------|------|
| F | 3.5 | 3.5 | 5.0 | 5.0 | 7.5 | 7.5 | 10.0 | 12.5 |
| φd | 0.5 | 0.6 | 0.6 | 0.6 | 0.8 | 0.8 | 0.8 | 1.0 |
| α | (L < 20) 1.5 | | | | (L ≥ 20) 2.0 | | | |
| β | (D < 20) 0.5 | | | | (D ≥ 20) 1.0 | | | |

PART NUMBER SYSTEM (EXAMPLE : 16V 470µF)



STANDARD RATINGS

| Voltage (Code) | | 6.3V (0J) | | 10V (1A) | | 16V (1C) | | 25V (1E) | |
|----------------|------|-----------|----------------|-----------|----------------|-----------|----------------|-----------|----------------|
| Cap. (µF) | Code | Case Size | Ripple Current | Case Size | Ripple Current | Case Size | Ripple Current | Case Size | Ripple Current |
| 220 | 227 | | | | | | | 8 x 12 | 370 |
| 330 | 337 | | | | | | | 8 x 12 | 453 |
| 470 | 477 | | | | | 8 x 12 | 499 | 10 x 12.5 | 628 |
| 680 | 687 | 8 x 12 | 503 | 8 x 12 | 546 | 10 x 12.5 | 690 | 10 x 16 | 826 |
| 1000 | 108 | 8 x 12 | 610 | 10 x 12.5 | 791 | 10 x 16 | 928 | 10 x 20 | 1094 |
| 1500 | 158 | 10 x 12.5 | 780 | 10 x 16 | 875 | 10 x 20 | 1025 | 12.5 x 20 | 1210 |
| 2200 | 228 | 10 x 16 | 890 | 10 x 20 | 1226 | 12.5 x 20 | 1555 | 12.5 x 25 | 1800 |
| 3300 | 338 | 10 x 20 | 1350 | 12.5 x 20 | 1685 | 12.5 x 25 | 1990 | 16 x 25 | 2304 |
| 4700 | 478 | 12.5 x 20 | 1822 | 12.5 x 25 | 2103 | 16 x 25 | 2487 | 16 x 30 | 2854 |
| 6800 | 688 | 12.5 x 25 | 1930 | 16 x 25 | 2606 | 16 x 30 | 3010 | 16 x 40 | 3528 |
| | | | | | | | | 18 x 35 | 3546 |
| 10000 | 109 | 16 x 25 | 2760 | 16 x 30 | 2960 | 16 x 35 | 3490 | | |
| 15000 | 159 | 16 x 35 | 2860 | 16 x 40 | 3100 | | | | |
| 22000 | 229 | 18 x 40 | 3400 | | | | | | |

Maximum Allowable Ripple Current (mArms) at 85°C 120Hz

Case Size Φ D x L (mm)

| Voltage (Code) | | 35V (1V) | | 50V (1H) | | 63V (1J) | | 100V (2A) | |
|----------------|------|-----------|----------------|-----------|----------------|-----------|----------------|-----------|----------------|
| Cap. (µF) | Code | Case Size | Ripple Current | Case Size | Ripple Current | Case Size | Ripple Current | Case Size | Ripple Current |
| 33 | 336 | | | | | | | 8 x 12 | 187 |
| 47 | 476 | | | | | | | 10 x 12.5 | 259 |
| 68 | 686 | | | | | 8 x 12 | 220 | 10 x 16 | 290 |
| 100 | 107 | | | 8 x 12 | 306 | 8 x 12 | 321 | 10 x 20 | 453 |
| 220 | 227 | 8 x 12 | 405 | 10 x 12.5 | 506 | 10 x 16 | 615 | 12.5 x 20 | 742 |
| 330 | 337 | 10 x 12.5 | 576 | 10 x 16 | 706 | 10 x 20 | 823 | 12.5 x 25 | 987 |
| 470 | 477 | 10 x 16 | 753 | 10 x 20 | 811 | 12.5 x 20 | 1153 | 16 x 25 | 1394 |
| 680 | 687 | 10 x 20 | 988 | 12.5 x 20 | 988 | 12.5 x 25 | 1512 | 16 x 30 | 1400 |
| 1000 | 108 | 12.5 x 20 | 1407 | 12.5 x 25 | 1715 | 16 x 25 | 2037 | 18 x 35 | 1995 |
| 2200 | 228 | 16 x 25 | 2134 | 16 x 30 | 2320 | 18 x 35 | 2300 | | |
| 3300 | 338 | 16 x 30 | 2338 | 18 x 35 | 3218 | 18 x 40 | 2500 | | |
| 4700 | 478 | 18 x 35 | 3400 | 18 x 40 | 3336 | | | | |
| 5600 | 568 | 18 x 40 | 3411 | | | | | | |
| 6800 | 688 | 18 x 40 | 3500 | | | | | | |

Maximum Allowable Ripple Current (mArms) at 85°C 120Hz

Case Size Φ D x L (mm)

Specifications are subject to change without notice. Should a safety or technical concern arise regarding the product, please be sure to contact our sales offices or agents immediately.

STANDARD RATINGS

| Voltage (Code) | | 160V (2C) | | 200V (2D) | | 250V (2E) | | 350V (2V) | |
|----------------|------|-----------|----------------|-----------|----------------|-----------|----------------|-----------|----------------|
| Cap. (μF) | Code | Case Size | Ripple Current | Case Size | Ripple Current | Case Size | Ripple Current | Case Size | Ripple Current |
| 3.3 | 335 | | | | | | | 8 x 12 | 56 |
| 4.7 | 475 | | | | | | | 10 x 12.5 | 77 |
| 10 | 106 | 8 x 12 | 82 | 8 x 12 | 90 | 10 x 12.5 | 113 | 10 x 16 | 120 |
| 22 | 226 | 10 x 16 | 150 | 10 x 16 | 168 | 10 x 20 | 185 | 12.5 x 20 | 233 |
| 33 | 336 | 10 x 20 | 243 | 10 x 20 | 245 | 10 x 20 | 198 | 16 x 25 | 312 |
| 47 | 476 | 10 x 20 | 307 | 12.5 x 20 | 343 | 12.5 x 20 | 235 | 16 x 25 | 413 |
| 68 | 686 | 12.5 x 20 | 350 | 12.5 x 25 | 350 | 16 x 25 | 380 | 16 x 25 | 450 |
| 100 | 107 | 12.5 x 25 | 541 | 16 x 25 | 601 | 16 x 25 | 572 | 18 x 35 | 518 |
| 220 | 227 | 16 x 30 | 976 | 16 x 35 | 1138 | | | | |
| 330 | 337 | 18 x 35 | 1346 | 18 x 35 | 1324 | | | | |

Maximum Allowable Ripple Current (mArms) at 85°C 120Hz

Case Size Φ D x L (mm)

| Voltage (Code) | | 400V (2G) | | 450V (2W) | |
|----------------|------|-----------|----------------|-----------|----------------|
| Cap. (μF) | Code | Case Size | Ripple Current | Case Size | Ripple Current |
| 2.2 | 225 | 8 x 12 | 47 | 8 x 12 | 40 |
| 3.3 | 335 | 8 x 12 | 55 | 10 x 12.5 | 54 |
| 4.7 | 475 | 10 x 12.5 | 73 | 10 x 16 | 72 |
| 10 | 106 | 10 x 16 | 120 | 10 x 20 | 98 |
| 22 | 226 | 12.5 x 20 | 230 | 12.5 x 25 | 202 |
| 33 | 336 | 16 x 25 | 345 | 16 x 25 | 271 |
| 47 | 476 | 16 x 25 | 437 | 16 x 30 | 355 |
| 68 | 686 | 16 x 30 | 500 | 18 x 35 | 360 |
| 82 | 826 | 16 x 30 | 550 | 18 x 40 | 385 |
| 100 | 107 | 18 x 35 | 720 | | |

Maximum Allowable Ripple Current (mArms) at 85°C 120Hz

Case Size Φ D x L (mm)

RIPPLE CURRENT MULTIPLIER

Frequency Coefficient

| Rated Voltage | Coefficient | | 50 | 120 | 300 | 1k | 10k~ |
|---------------|-------------|------------|------|------|------|------|------|
| | Cap. (μF) | Freq. (Hz) | | | | | |
| 6.3~100V | ≤47 | | 0.75 | 1.00 | 1.35 | 1.57 | 2.00 |
| | 68~470 | | 0.80 | 1.00 | 1.23 | 1.34 | 1.50 |
| | ≥560 | | 0.85 | 1.00 | 1.10 | 1.13 | 1.15 |
| 160~450V | 2.2~220 | | 0.80 | 1.00 | 1.25 | 1.40 | 1.60 |
| | ≥270 | | 0.90 | 1.00 | 1.10 | 1.13 | 1.15 |

Specifications are subject to change without notice. Should a safety or technical concern arise regarding the product, please be sure to contact our sales offices or agents immediately.

FEATURES

- Rated working voltage range 6.3 to 100V DC / 160 to 450V DC at operation temperature range -40 to +105°C / -25 to +105°C.
- This series is for communication equipments, switching power supply, industrial measuring instruments, automotive electric products, etc.



SPECIFICATIONS

| Item | Performance Characteristics | |
|--|---|--|
| Operating Temperature Range | -40 to +105°C | -25 to +105°C |
| Rated Working Voltage Range | 6.3 to 100V | 160 to 450V |
| Nominal Capacitance Range | 0.47 to 33000µF | |
| Capacitance Tolerance | ±20% at 120Hz, +20°C | |
| Leakage Current | I ≤ 0.01CV or 3 (µA) whichever is greater measured after 2 minutes application of rated working voltage at +20°C | I ≤ 0.03CV + 40 (µA) after 2 minutes application of rated working voltage at +20°C |
| tan δ (120Hz, +20°C) | Working Voltage (V) | 6.3 10 16 25 35 50 63 100 |
| | tan δ (max.) | 0.26 0.22 0.18 0.16 0.14 0.12 0.10 0.08 |
| | Working Voltage (V) | 160 200 220 250 350 400 420 450 |
| | tan δ (max.) | 0.20 0.20 0.20 0.20 0.24 0.24 0.24 0.24 |
| For capacitance value > 1000µF, add 0.02 per another 1000µF | | |
| Low Temperature Characteristics | Impedance ratio max. at 120Hz | |
| | Working Voltage (V) | 6.3 10 16 25 35 50 63 100 |
| | Z-25°C / Z+20°C | 5 4 3 2 2 2 2 2 |
| | Z-40°C / Z+20°C | 10 8 6 4 3 3 3 3 |
| Working Voltage (V) | 160 200 220 250 350 400 420 450 | |
| Z-25°C / Z+20°C | 3 3 3 4 4 6 6 15 | |
| For capacitance value > 1000µF, add 0.5 per another 1000µF for Z-25°C / Z+20°C add 1.0 per another 1000µF for Z-40°C / Z+20°C | | |
| High Temperature Loading | Test time : 2,000 hours Test temperature : +105°C Test conditions : Rated DC working voltage with rated ripple current. | Post test requirements at +20°C Leakage current : ≤ Initial specified value Cap. change : within ±20% of the initial measured value tan δ : ≤ 200% of the initial specified value |
| Shelf Life | At +105°C no voltage applied after 1,000 hours and then being stabilized at +20°C the capacitors shall meet the following limits Leakage current : ≤ Initial specified value Cap. change : within ±20% of the initial measured value tan δ : ≤ 200% of the initial specified value | |
| Industrial Standard | JIS C - 5101-4 (IEC 60384-4) | |

CASE SIZE TABLE



| φD | 5 | 6.3 | 8 (L < 20) | 8 (L ≥ 20) | 10 | 12.5 | 16 | 18 | 22 | 25 |
|----|--------------|-----|------------|------------|--------------|------|-----|-----|------|------|
| F | 2.0 | 2.5 | 3.5 | 3.5 | 5.0 | 5.0 | 7.5 | 7.5 | 10.0 | 12.5 |
| φd | 0.5 | 0.5 | 0.5 | 0.6 | 0.6 | 0.6 | 0.8 | 0.8 | 0.8 | 1.0 |
| α | (L < 20) 1.5 | | | | (L ≥ 20) 2.0 | | | | | |
| β | (D < 20) 0.5 | | | | (D ≥ 20) 1.0 | | | | | |

PART NUMBER SYSTEM (EXAMPLE : 25V 330µF)



STANDARD RATINGS

| Voltage (Code) | | 6.3V (0J) | | 10V (1A) | | 16V (1C) | | 25V (1E) | |
|----------------|------|-----------|----------------|-----------|----------------|-----------|----------------|-----------|----------------|
| Cap. (μF) | Code | Case Size | Ripple Current | Case Size | Ripple Current | Case Size | Ripple Current | Case Size | Ripple Current |
| 4.7 | 475 | | | | | | | 5 x 11 | 26 |
| 10 | 106 | | | | | 5 x 11 | 35 | 5 x 11 | 38 |
| 22 | 226 | | | 5 x 11 | 49 | 5 x 11 | 54 | 5 x 11 | 57 |
| 33 | 336 | 5 x 11 | 54 | 5 x 11 | 60 | 5 x 11 | 64 | 5 x 11 | 75 |
| 47 | 476 | 5 x 11 | 65 | 5 x 11 | 70 | 5 x 11 | 80 | 5 x 11 | 84 |
| 68 | 686 | 5 x 11 | 70 | 5 x 11 | 75 | 5 x 11 | 90 | 5 x 11 | 92 |
| 100 | 107 | 5 x 11 | 95 | 5 x 11 | 105 | 5 x 11 | 125 | 5 x 11 | 140 |
| | | | | | | 6.3 x 11 | 142 | 6.3 x 11 | 159 |
| 220 | 227 | 5 x 11 | 153 | 5 x 11 | 170 | 6.3 x 11 | 213 | 8 x 12 | 285 |
| | | | | 6.3 x 11 | 193 | | | | |
| 330 | 337 | 6.3 x 11 | 216 | 6.3 x 11 | 239 | 8 x 12 | 315 | 8 x 12 | 340 |
| 470 | 477 | 6.3 x 11 | 258 | 6.3 x 11 | 285 | 8 x 12 | 366 | 8 x 12 | 406 |
| 680 | 687 | 8 x 12 | 365 | 8 x 12 | 408 | 10 x 12.5 | 480 | 10 x 12.5 | 471 |
| | | | | | | | | 10 x 16 | 620 |
| 1000 | 108 | 8 x 12 | 443 | 10 x 12.5 | 571 | 8 x 20 | 663 | 10 x 20 | 821 |
| | | | | | | 10 x 16 | 680 | | |
| 2200 | 228 | 10 x 16 | 740 | 10 x 20 | 886 | 12.5 x 20 | 1108 | 12.5 x 20 | 1176 |
| | | | | | | | | 12.5 x 25 | 1296 |
| 3300 | 338 | 10 x 20 | 1032 | 12.5 x 20 | 1205 | 12.5 x 25 | 1389 | 16 x 25 | 1646 |
| 4700 | 478 | 12.5 x 20 | 1280 | 12.5 x 25 | 1492 | 16 x 25 | 1740 | 16 x 30 | 2012 |
| 6800 | 688 | 12.5 x 25 | 1554 | 16 x 25 | 1824 | 16 x 30 | 2081 | 16 x 35 | 2308 |
| 10000 | 109 | 16 x 25 | 1897 | 16 x 30 | 1980 | 16 x 35 | 2379 | 18 x 35 | 2500 |
| 15000 | 159 | 16 x 30 | 2188 | 16 x 40 | 2180 | 18 x 35 | 2600 | | |
| 22000 | 229 | 18 x 35 | 2400 | 18 x 40 | 2407 | | | | |
| 33000 | 339 | 18 x 40 | 2555 | | | | | | |

Maximum Allowable Ripple Current (mArms) at 105°C 120Hz

Case Size Φ D x L (mm)

| Voltage (Code) | | 35V (1V) | | 50V (1H) | | 63V (1J) | | 100V (2A) | |
|----------------|------|-----------|----------------|-----------|----------------|-----------|----------------|-----------|----------------|
| Cap. (μF) | Code | Case Size | Ripple Current | Case Size | Ripple Current | Case Size | Ripple Current | Case Size | Ripple Current |
| 1 | 105 | | | 5 x 11 | 13 | | | 5 x 11 | 16 |
| 2.2 | 225 | | | 5 x 11 | 20 | | | 5 x 11 | 23 |
| 3.3 | 335 | | | 5 x 11 | 30 | | | 5 x 11 | 34 |
| 4.7 | 475 | 5 x 11 | 28 | 5 x 11 | 37 | 5 x 11 | 40 | 5 x 11 | 40 |
| 10 | 106 | 5 x 11 | 41 | 5 x 11 | 54 | 5 x 11 | 59 | 6.3 x 11 | 61 |
| 22 | 226 | 5 x 11 | 67 | 5 x 11 | 79 | 5 x 11 | 79 | 6.3 x 11 | 92 |
| 33 | 336 | 5 x 11 | 80 | 5 x 11 | 101 | 6.3 x 11 | 122 | 8 x 12 | 144 |
| 47 | 476 | 5 x 11 | 101 | 6.3 x 11 | 133 | 6.3 x 11 | 146 | 10 x 12.5 | 199 |
| 68 | 686 | 6.3 x 11 | 138 | 6.3 x 11 | 160 | 8 x 12 | 155 | 10 x 16 | 240 |
| 100 | 107 | 6.3 x 11 | 168 | 8 x 12 | 229 | 10 x 12.5 | 251 | 10 x 20 | 349 |
| 220 | 227 | 8 x 12 | 294 | 10 x 16 | 509 | 10 x 20 | 504 | 12.5 x 25 | 662 |
| 330 | 337 | 10 x 12.5 | 419 | 10 x 16 | 589 | 12.5 x 20 | 688 | 12.5 x 25 | 800 |
| 470 | 477 | 10 x 16 | 547 | 10 x 20 | 707 | 12.5 x 20 | 810 | 16 x 25 | 990 |
| 680 | 687 | 10 x 20 | 682 | 12.5 x 20 | 923 | 12.5 x 25 | 1160 | 16 x 30 | 1289 |
| 1000 | 108 | 12.5 x 20 | 1023 | 12.5 x 25 | 1287 | 16 x 25 | 1448 | 18 x 35 | 1903 |
| | | | | 16 x 25 | 1478 | | | 18 x 40 | 2020 |
| 2200 | 228 | 16 x 25 | 1497 | 16 x 30 | 1759 | 18 x 35 | 1781 | | |
| | | | | 16 x 35 | 1884 | | | | |
| 3300 | 338 | 16 x 30 | 1808 | 18 x 35 | 2167 | | | | |
| 4700 | 478 | 18 x 35 | 2335 | | | | | | |
| 6800 | 688 | 18 x 40 | 2400 | | | | | | |

Maximum Allowable Ripple Current (mArms) at 105°C 120Hz

Case Size Φ D x L (mm)

Specifications are subject to change without notice. Should a safety or technical concern arise regarding the product, please be sure to contact our sales offices or agents immediately.

STANDARD RATINGS

| Voltage (Code) | | 160V (2C) | | 200V (2D) | | 220V (2N) | | 250V (2E) | |
|----------------|------|-----------|----------------|-----------|----------------|-----------|----------------|-----------|----------------|
| Cap. (μF) | Code | Case Size | Ripple Current | Case Size | Ripple Current | Case Size | Ripple Current | Case Size | Ripple Current |
| 0.47 | 474 | | | | | | | 6.3 x 11 | 8 |
| 1 | 105 | | | | | | | 6.3 x 11 | 17 |
| 2.2 | 225 | | | | | | | 6.3 x 11 | 27 |
| 3.3 | 335 | | | 6.3 x 11 | 30 | 6.3 x 11 | 30 | 6.3 x 11 | 35 |
| 4.7 | 475 | 6.3 x 11 | 41 | 6.3 x 11 | 40 | 8 x 12 | 40 | 8 x 12 | 45 |
| 10 | 106 | 8 x 12 | 60 | 10 x 12.5 | 72 | 10 x 12.5 | 70 | 10 x 12.5 | 75 |
| | | | | 10 x 16 | 79 | | | | |
| 22 | 226 | 10 x 16 | 110 | 10 x 16 | 113 | 10 x 20 | 125 | 10 x 20 | 130 |
| 33 | 336 | 10 x 20 | 156 | 10 x 20 | 165 | 12.5 x 20 | 165 | 12.5 x 20 | 184 |
| 47 | 476 | 10 x 20 | 195 | 10 x 20 | 194 | 12.5 x 20 | 220 | 12.5 x 25 | 238 |
| 68 | 686 | 12.5 x 20 | 250 | 12.5 x 20 | 226 | 12.5 x 25 | 245 | 16 x 20 | 246 |
| | | | | 12.5 x 25 | 250 | | | | |
| 82 | 826 | 12.5 x 25 | 310 | 10 x 30 | 320 | 12.5 x 30 | 280 | 16 x 25 | 351 |
| 100 | 107 | 12.5 x 25 | 360 | 16 x 25 | 386 | 16 x 25 | 335 | 16 x 25 | 390 |
| | | | | | | | | 16 x 30 | 422 |
| | | | | | | | | 18 x 30 | 440 |
| 150 | 157 | 12.5 x 30 | 380 | 16 x 25 | 525 | 16 x 30 | 365 | 18 x 30 | 440 |
| 180 | 187 | 12.5 x 35 | 420 | 12.5 x 35 | 560 | 16 x 35 | 500 | 18 x 35 | 469 |
| 220 | 227 | 16 x 30 | 680 | 16 x 30 | 643 | 16 x 40 | 615 | 18 x 35 | 485 |
| | | | | 18 x 25 | 635 | | | | |
| 270 | 277 | 16 x 30 | 728 | 18 x 30 | 740 | | | | |
| 330 | 337 | 18 x 35 | 830 | 18 x 30 | 808 | | | | |
| | | | | 18 x 35 | 864 | | | | |
| 390 | 397 | 18 x 35 | 850 | 18 x 35 | 904 | 18 x 40 | 959 | | |
| 470 | 477 | 18 x 40 | 880 | 18 x 40 | 1016 | | | | |
| 560 | 567 | 18 x 45 | 925 | 18 x 45 | 1112 | | | | |

Maximum Allowable Ripple Current (mArms) at 105°C 120Hz

Case Size Φ D x L (mm)

Specifications are subject to change without notice. Should a safety or technical concern arise regarding the product, please be sure to contact our sales offices or agents immediately.

STANDARD RATINGS

| Voltage (Code) | | 350V (2V) | | 400V (2G) | | 420V (2M) | | 450V (2W) | |
|----------------|------|-----------|----------------|-----------|----------------|-----------|----------------|-----------|----------------|
| Cap. (μF) | Code | Case Size | Ripple Current | Case Size | Ripple Current | Case Size | Ripple Current | Case Size | Ripple Current |
| 0.47 | 474 | 6.3 x 11 | 8 | 6.3 x 11 | 8 | 6.3 x 11 | 8 | | |
| 1 | 105 | 6.3 x 11 | 18 | 6.3 x 11 | 19 | 6.3 x 11 | 15 | 6.3 x 11 | 16 |
| 2.2 | 225 | 6.3 x 11 | 25 | 6.3 x 11 | 25 | 8 x 12 | 29 | 8 x 12 | 24 |
| 3.3 | 335 | 8 x 12 | 40 | 8 x 12 | 35 | 8 x 12 | 35 | 8 x 12 | 29 |
| 4.7 | 475 | 8 x 12 | 43 | 8 x 12 | 40 | 10 x 12.5 | 46 | 10 x 12.5 | 37 |
| | | | | 10 x 12.5 | 46 | 10 x 16 | 52 | 10 x 16 | 42 |
| | | | | 8 x 16 | 68 | 10 x 16 | 77 | 10 x 20 | 74 |
| 10 | 106 | 10 x 16 | 73 | 10 x 12.5 | 70 | 10 x 20 | 85 | 12.5 x 20 | 84 |
| | | | | 10 x 16 | 78 | | | | |
| 18 | 186 | 12.5 x 20 | 100 | 12.5 x 20 | 105 | 12.5 x 25 | 124 | 10 x 30 | 108 |
| | | | | 12.5 x 20 | 148 | 12.5 x 20 | 126 | 12.5 x 20 | 118 |
| 22 | 226 | 12.5 x 20 | 150 | 12.5 x 25 | 163 | 12.5 x 25 | 140 | 12.5 x 25 | 131 |
| | | | | 10 x 30 | 192 | | | | |
| 27 | 276 | 12.5 x 25 | 177 | 12.5 x 20 | 181 | 12.5 x 25 | 170 | 12.5 x 30 | 164 |
| | | | | 12.5 x 20 | 175 | | | 16 x 20 | 215 |
| 33 | 336 | 16 x 25 | 200 | 12.5 x 25 | 193 | 16 x 25 | 200 | 16 x 25 | 237 |
| 39 | 396 | 16 x 25 | 258 | 16 x 25 | 251 | 12.5 x 30 | 248 | 12.5 x 35 | 256 |
| | | | | 12.5 x 25 | 245 | 12.5 x 35 | 288 | 16 x 25 | 281 |
| 47 | 476 | 16 x 25 | 265 | 12.5 x 30 | 266 | | | 16 x 30 | 305 |
| | | | | 16 x 20 | 256 | 18 x 20 | 277 | | |
| | | | | 12.5 x 30 | 313 | | | | |
| 56 | 566 | 16 x 30 | 280 | 12.5 x 35 | 336 | 12.5 x 40 | 344 | 16 x 30 | 352 |
| | | | | 16 x 25 | 365 | | | 16 x 30 | 342 |
| 68 | 686 | 16 x 30 | 288 | 16 x 30 | 396 | 16 x 30 | 408 | 18 x 30 | 366 |
| | | | | 18 x 20 | 356 | | | | |
| | | | | 16 x 30 | 414 | 16 x 35 | 456 | | |
| 82 | 826 | 18 x 30 | 372 | 18 x 25 | 409 | | | 18 x 30 | 440 |
| | | | | 18 x 30 | 443 | 18 x 25 | 420 | | |
| | | | | 16 x 30 | 457 | | | 16 x 35 | 459 |
| 100 | 107 | 18 x 35 | 460 | 18 x 25 | 452 | 18 x 35 | 488 | 18 x 30 | 457 |
| | | | | 18 x 30 | 489 | | | 18 x 35 | 490 |
| | | | | 16 x 40 | 567 | 18 x 30 | 464 | | |
| 120 | 127 | | | 18 x 30 | 532 | | | 18 x 40 | 592 |
| | | | | 18 x 35 | 570 | 18 x 40 | 528 | | |
| | | | | 16 x 40 | 577 | 18 x 35 | 507 | 18 x 40 | 606 |
| 150 | 157 | | | 18 x 35 | 580 | | | 18 x 45 | 640 |
| | | | | 18 x 40 | 616 | 18 x 45 | 568 | | |
| | | | | 18 x 40 | 636 | 18 x 40 | 573 | | |
| 180 | 187 | | | 18 x 50 | 704 | 18 x 45 | 622 | | |

Maximum Allowable Ripple Current (mArms) at 105°C 120Hz

Case Size Φ D x L (mm)

RIPPLE CURRENT MULTIPLIER

Frequency Coefficient

| Rated Voltage | Coefficient | | Freq. (Hz) | | | | |
|---------------|-------------|--|------------|------|------|------|------|
| | Cap. (μF) | | 50 | 120 | 300 | 1k | 10k~ |
| 6.3~100V | ≤47 | | 0.75 | 1.00 | 1.35 | 1.57 | 2.00 |
| | 68~470 | | 0.80 | 1.00 | 1.23 | 1.34 | 1.50 |
| | ≥560 | | 0.85 | 1.00 | 1.10 | 1.13 | 1.15 |
| 160~450V | 0.47~220 | | 0.80 | 1.00 | 1.25 | 1.40 | 1.60 |
| | ≥270 | | 0.90 | 1.00 | 1.10 | 1.13 | 1.15 |

Specifications are subject to change without notice. Should a safety or technical concern arise regarding the product, please be sure to contact our sales offices or agents immediately.

FEATURES

- For general purpose, -55°C to +105°C, 1,000 to 2,000 hours.
- Wide CV value range.
- Safety vent construction products.



SPECIFICATIONS

| Item | Performance Characteristics | | | | | | | | | |
|---|--|--------|--------|---------|---|------|------|------|------|--|
| Operating Temperature Range | -55 to +105°C | | | | | | | | | |
| Rated Working Voltage Range | 6.3 to 100V | | | | | | | | | |
| Nominal Capacitance Range | 2.2 to 22000µF | | | | | | | | | |
| Capacitance Tolerance | ±20% at 120Hz, +20°C | | | | | | | | | |
| Leakage Current | I ≤ 0.01CV or 3 (µA) whichever is greater measured after 2 minutes application of rated working voltage at +20°C | | | | | | | | | |
| tan δ (120Hz, +20°C) | Working Voltage (V) | 6.3 | 10 | 16 | 25 | 35 | 50 | 63 | 100 | |
| | tan δ (max.) | 0.28 | 0.24 | 0.20 | 0.16 | 0.14 | 0.12 | 0.10 | 0.08 | |
| | For capacitance value >1000µF, add 0.02 per another 1000µF | | | | | | | | | |
| Low Temperature Characteristics | Impedance ratio max. at 120Hz | | | | | | | | | |
| | Working Voltage (V) | 6.3 | 10 | 16 | 25 | 35 | 50 | 63 | 100 | |
| | Z-25°C / Z+20°C | 4 | 3 | 2 | 2 | 2 | 2 | 2 | 2 | |
| | Z-40°C / Z+20°C | 10 | 8 | 6 | 4 | 3 | 3 | 3 | 3 | |
| For capacitance value >1000µF, add 0.5 per another 1000µF for Z-25°C / Z+20°C add 1.0 per another 1000µF for Z-40°C / Z+20°C | | | | | | | | | | |
| High Temperature Loading | Test time | ΦD | 5 ~ 8 | 10 ~ 18 | Post test requirements at +20°C | | | | | |
| | Load life | | 1,000h | 2,000h | Leakage current : ≤ Initial specified value | | | | | |
| | Test temperature | +105°C | | | Cap. change : within ±20% of the initial measured value | | | | | |
| Test conditions : Rated DC working voltage with rated ripple current | | | | | | | | | | |
| tan δ : ≤ 200% of the initial specified value | | | | | | | | | | |
| Shelf Life | At +105°C no voltage applied after 1,000 hours and then being stabilized at +20°C the capacitors shall meet the following limits | | | | | | | | | |
| | Leakage current : ≤ Initial specified value | | | | | | | | | |
| | Cap. change : within ±20% of the initial measured value | | | | | | | | | |
| tan δ : ≤ 200% of the initial specified value | | | | | | | | | | |
| Industrial Standard | JIS C - 5101-4 (IEC 60384-4) | | | | | | | | | |

CASE SIZE TABLE



| | 5 | 6.3 | 8 (L < 20) | 8 (L ≥ 20) | 10 | 12.5 | 16 | 18 |
|----|--------------|-----|------------|--------------|-----|------|-----|-----|
| F | 2.0 | 2.5 | 3.5 | 3.5 | 5.0 | 5.0 | 7.5 | 7.5 |
| φd | 0.5 | 0.5 | 0.5 | 0.6 | 0.6 | 0.6 | 0.8 | 0.8 |
| α | (L < 20) 1.5 | | | (L ≥ 20) 2.0 | | | | |
| β | (D < 20) 0.5 | | | (D ≥ 20) 1.0 | | | | |

PART NUMBER SYSTEM (EXAMPLE : 16V 470µF)



STANDARD RATINGS

| Voltage (Code) | | 6.3V (0J) | | 10V (1A) | | 16V (1C) | | 25V (1E) | |
|----------------|------|-----------|----------------|-----------|----------------|-----------|----------------|-----------|----------------|
| Cap. (μF) | Code | Case Size | Ripple Current | Case Size | Ripple Current | Case Size | Ripple Current | Case Size | Ripple Current |
| 47 | 476 | | | | | | | 5 x 11 | 91 |
| 100 | 107 | | | | | 5 x 11 | 110 | 6.3 x 11 | 130 |
| 220 | 227 | 5 x 11 | 140 | | | 6.3 x 11 | 180 | 8 x 12 | 230 |
| 330 | 337 | | | 6.3 x 11 | 200 | 8 x 12 | 260 | 8 x 12 | 310 |
| 470 | 477 | 6.3 x 11 | 230 | 6.3 x 11 | 240 | 8 x 12 | 310 | 10 x 12.5 | 380 |
| 1000 | 108 | 8 x 12 | 380 | 10 x 12.5 | 460 | 10 x 16 | 560 | 10 x 20 | 680 |
| 2200 | 228 | 10 x 16 | 710 | 10 x 20 | 760 | 12.5 x 20 | 920 | 12.5 x 20 | 988 |
| 3300 | 338 | 10 x 20 | 840 | 12.5 x 20 | 1000 | 12.5 x 25 | 1170 | 16 x 25 | 1400 |
| 4700 | 478 | 12.5 x 20 | 1090 | 12.5 x 25 | 1260 | 16 x 25 | 1480 | 16 x 30 | 1750 |
| 6800 | 688 | 12.5 x 25 | 1350 | 16 x 25 | 1570 | 16 x 30 | 1780 | 16 x 35 | 1910 |
| 10000 | 109 | 16 x 25 | 1650 | 16 x 30 | 1890 | 16 x 35 | 1930 | | |
| 15000 | 159 | 16 x 30 | 2010 | 16 x 40 | 2170 | | | | |
| 22000 | 229 | 18 x 35 | 2350 | | | | | | |

Maximum Allowable Ripple Current (mArms) at 105°C 120Hz

Case Size ΦD x L (mm)

| Voltage (Code) | | 35V (1V) | | 50V (1H) | | 63V (1J) | | 100V (2A) | |
|----------------|------|-----------|----------------|-----------|----------------|-----------|----------------|-----------|----------------|
| Cap. (μF) | Code | Case Size | Ripple Current | Case Size | Ripple Current | Case Size | Ripple Current | Case Size | Ripple Current |
| 2.2 | 225 | | | 5 x 11 | 18 | | | 5 x 11 | 21 |
| 3.3 | 335 | | | 5 x 11 | 22 | | | 5 x 11 | 31 |
| 4.7 | 475 | | | 5 x 11 | 26 | | | 5 x 11 | 38 |
| 10 | 106 | | | 5 x 11 | 39 | 5 x 11 | 46 | 6.3 x 11 | 54 |
| 22 | 226 | | | 5 x 11 | 65 | 5 x 11 | 71 | 6.3 x 11 | 93 |
| 33 | 336 | | | 5 x 11 | 90 | 6.3 x 11 | 100 | 8 x 12 | 130 |
| 47 | 476 | 5 x 11 | 90 | 6.3 x 11 | 110 | 6.3 x 11 | 120 | 10 x 12.5 | 165 |
| 100 | 107 | 6.3 x 11 | 150 | 8 x 12 | 180 | 10 x 12.5 | 215 | 10 x 20 | 265 |
| 220 | 227 | 8 x 12 | 270 | 10 x 16 | 330 | 10 x 20 | 370 | 12.5 x 25 | 440 |
| 330 | 337 | 10 x 12.5 | 350 | 10 x 16 | 410 | 12.5 x 20 | 578 | 12.5 x 25 | 600 |
| 470 | 477 | 10 x 16 | 460 | 10 x 20 | 530 | 12.5 x 20 | 640 | 16 x 25 | 715 |
| 1000 | 108 | 12.5 x 20 | 810 | 12.5 x 25 | 950 | 16 x 25 | 930 | 18 x 40 | 1040 |
| 2200 | 228 | 16 x 25 | 1260 | 16 x 35 | 1570 | 18 x 35 | 1610 | | |
| 3300 | 338 | 16 x 30 | 1610 | 18 x 35 | 1770 | | | | |
| 4700 | 478 | 18 x 35 | 1910 | | | | | | |

Maximum Allowable Ripple Current (mArms) at 105°C 120Hz

Case Size ΦD x L (mm)

RIPPLE CURRENT MULTIPLIER

Frequency Coefficient

| Coefficient Cap. (μF) | Freq. (Hz) | 60 | 120 | 1k | 10k | 100k |
|--------------------------|------------|------|------|------|------|------|
| 0.1~33 | | 0.75 | 1.00 | 1.55 | 1.80 | 2.00 |
| 47~470 | | 0.80 | 1.00 | 1.35 | 1.50 | 1.50 |
| 1000~22000 | | 0.85 | 1.00 | 1.10 | 1.15 | 1.15 |

Specifications are subject to change without notice. Should a safety or technical concern arise regarding the product, please be sure to contact our sales offices or agents immediately.

FEATURES

- Doesn't spark with DC over voltage.
- Load life: 2,000 hours at 105°C.



SPECIFICATIONS

| Item | Performance Characteristics | | |
|---------------------------------|---|---|------|
| Operating Temperature Range | -25 to +105°C | | |
| Rated Working Voltage Range | 200 & 400V | | |
| Nominal Capacitance Range | 22 to 330µF | | |
| Capacitance Tolerance | ±20% at 120Hz, +20°C | | |
| Leakage Current | I ≤ 0.03CV + 40 (µA) after 2 minutes application of rated working voltage at +20°C | | |
| tan δ (120Hz, +20°C) | Working Voltage (V) | 200 | 400 |
| | tan δ (max.) | 0.20 | 0.24 |
| Low Temperature Characteristics | Impedance ratio max. at 120Hz | | |
| | Rated Voltage (V) | 200 | 400 |
| High Temperature Loading | Z-25°C / Z+20°C | 3 | 6 |
| | Test time : 2,000 hours | Post test requirements at +20°C | |
| Shelf Life | Test temperature : +105°C | Leakage current : ≤ Initial specified value | |
| | Test conditions : Rated DC working voltage with rated ripple current | Cap. change : within ±20% of the initial measured value | |
| | | tan δ : ≤ 200% of the initial specified value | |
| Industrial Standard | JIS C - 5101-4 (IEC 60384-4) | | |

CASE SIZE TABLE



| | | |
|----|--------------|--------------|
| φD | 16 | 18 |
| F | 7.5 | 7.5 |
| φd | 0.8 | 0.8 |
| α | (L < 20) 1.5 | (L ≥ 20) 2.0 |
| β | (D < 20) 0.5 | (D ≥ 20) 1.0 |

RIPPLE CURRENT MULTIPLIER

Frequency Coefficient

| Coefficient | 50 | 120 | 300 | 1k | 10k~ |
|-------------|------|------|------|------|------|
| Cap (µF) | | | | | |
| 22~220 | 0.80 | 1.00 | 1.25 | 1.40 | 1.60 |
| 270~330 | 0.90 | 1.00 | 1.10 | 1.13 | 1.15 |

PART NUMBER SYSTEM (EXAMPLE : 200V 100µF)



STANDARD RATINGS

| Voltage (Code) | | 200V (2D) | | 400V (2G) | |
|----------------|------|-----------|----------------|-----------|----------------|
| Cap. (µF) | Code | Case Size | Ripple Current | Case Size | Ripple Current |
| 22 | 226 | | | 16 x 20 | 145 |
| 33 | 336 | | | 16 x 25 | 220 |
| | | | | 18 x 20 | 225 |
| 39 | 396 | | | 16 x 30 | 245 |
| | | | | 18 x 25 | 250 |
| 47 | 476 | | | 16 x 30 | 275 |
| | | | | 18 x 25 | 280 |
| 56 | 566 | | | 16 x 40 | 350 |
| | | | | 18 x 30 | 315 |
| 68 | 686 | | | 18 x 35 | 350 |
| 82 | 826 | 16 x 20 | 230 | 18 x 40 | 395 |
| 100 | 107 | 16 x 25 | 425 | | |
| | | 18 x 20 | 250 | 18 x 40 | 450 |
| 120 | 127 | 16 x 30 | 500 | | |
| | | 18 x 25 | 475 | | |
| 150 | 157 | 16 x 30 | 560 | | |
| | | 18 x 25 | 530 | | |
| 180 | 187 | 16 x 40 | 645 | | |
| | | 18 x 30 | 630 | | |
| 220 | 227 | 18 x 35 | 725 | | |
| 270 | 277 | 18 x 45 | 830 | | |
| 330 | 337 | 18 x 45 | 920 | | |

Maximum Allowable Ripple Current (mA_{rms}) at 105°C 120Hz

Case Size ΦD x L (mm)

DC OVERVOLTAGE TEST CONDITIONS

They vent will operate and the capacitor shall become an open circuit without buming materials when the following excess DC voltage is applied.

● Test DC voltage

| Rated voltage | Current limit | Test DC voltage |
|---------------|---------------|-----------------|
| 200Vdc | 4A | 300 / 375Vdc |
| 400Vdc | 2A | 500 / 600Vdc |

● Test circuit



Constant DC voltage / current power supply

Specifications are subject to change without notice. Should a safety or technical concern arise regarding the product, please be sure to contact our sales offices or agents immediately.

FEATURES

- Low impedance for high frequency.
- Life time: 1,000~4,000 hours at 105°C.

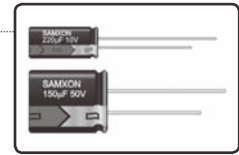

SPECIFICATIONS

| Item | Performance Characteristics | | | | | | | | | |
|--|--|--|--------|--------|--------|---|---------------------------------|------|------|---|
| Operating Temperature Range | -40 to +105°C | | | | | | | | | |
| Rated Working Voltage Range | 6.3 to 100V | | | | | | | | | |
| Nominal Capacitance Range | 3.3 to 4700µF | | | | | | | | | |
| Capacitance Tolerance | ±20% at 120Hz, +20°C | | | | | | | | | |
| Leakage Current | I ≤ 0.01CV or 3 (µA) whichever is greater measured after 2 minutes application of rated working voltage at +20°C | | | | | | | | | |
| tan δ (120Hz, +20°C) | Working Voltage (V) | 6.3 | 10 | 16 | 25 | 35 | 50 | 63 | 100 | |
| | tan δ (max.) | 0.22 | 0.19 | 0.16 | 0.14 | 0.12 | 0.10 | 0.09 | 0.08 | |
| For capacitance value >1000µF, add 0.02 per another 1000µF | | | | | | | | | | |
| Low Temperature Characteristics | Impedance ratio max. at 120Hz | | | | | | | | | |
| | Working Voltage (V) | 6.3 | 10 | 16 | 25 | 35 | 50 | 63 | 100 | |
| | Z-25°C / Z+20°C | 4 | 3 | 2 | 2 | 2 | 2 | 2 | 2 | 2 |
| | Z-40°C / Z+20°C | 8 | 6 | 4 | 3 | 3 | 3 | 3 | 3 | 3 |
| High Temperature Loading | Test time | φD | L ≤ 7 | D5-6.3 | D8-10 | D12.5 | Post test requirements at +20°C | | | |
| | Load life | 1,000h | 2,000h | 3,000h | 4,000h | Leakage current : ≤ Initial specified value | | | | |
| | Test temperature | : +105°C | | | | Cap. change : within ±25% of the initial measured value | | | | |
| | Test conditions | : Rated DC working voltage with rated ripple current | | | | tan δ : ≤ 150% of the initial specified value | | | | |
| Shelf Life | At +105°C no voltage applied after 1,000 hours and then being stabilized at +20°C the capacitors shall meet the following limits | | | | | | | | | |
| | Leakage current | : ≤ Initial specified value | | | | | | | | |
| | Cap. change | : within ±25% of the initial measured value | | | | | | | | |
| | tan δ | : ≤ 150% of the initial specified value | | | | | | | | |
| Industrial Standard | JIS C - 5101-4 (IEC 60384-4) | | | | | | | | | |

CASE SIZE TABLE



| | | | | | | | |
|----|------|--------------|------------------|--------------|------------|-----|------|
| φD | 4 | 5 | 6.3 | 8 (L < 20) | 8 (L ≥ 20) | 10 | 12.5 |
| F | 1.5 | 2.0 | 2.5 | 3.5 | 3.5 | 5.0 | 5.0 |
| φd | 0.45 | (L ≤ 7) 0.45 | (L ≥ 9) 0.50 | 0.6 | 0.6 | 0.6 | 0.6 |
| α | | (L ≤ 7) 1 | (L ≤ 9 < 20) 1.5 | (L ≥ 20) 2.0 | | | |
| β | | | (D < 20) 0.5 | (D ≥ 20) 1.0 | | | |

PART NUMBER SYSTEM (EXAMPLE : 6.3V 1000µF)

| | | | | | | | | |
|---|-----|-------|---|-----|----|-------|-------|----------------------|
| 1 | 2 3 | 4 5 6 | 7 | 8 9 | 10 | 11 12 | 13 14 | |
| E | GF | 108 | M | OJ | G | 1B | RR | |
| | | | | | | | | Type (Radial Bulk) |
| | | | | | | | | Case Length (12.5mm) |
| | | | | | | | | Diameter (10mm) |
| | | | | | | | | Voltage (6.3V) |
| | | | | | | | | Tolerance (±20%) |
| | | | | | | | | Capacitance (1000µF) |
| | | | | | | | | Series |
| | | | | | | | | E-CAP |



STANDARD RATINGS

| Voltage (Code) | | 6.3V (0J) | | | 10V (1A) | | | 16V (1C) | | |
|----------------|------|-----------|-----------|----------------|-----------|-----------|----------------|-----------|-----------|----------------|
| Cap. (μF) | Code | Case Size | Impedance | Ripple Current | Case Size | Impedance | Ripple Current | Case Size | Impedance | Ripple Current |
| 10 | 106 | | | | | | | 4 x 5 | 5.000 | 50 |
| 15 | 156 | | | | | | | 4 x 7 | 3.300 | 70 |
| | | | | | | | | 5 x 5 | 2.600 | 80 |
| 22 | 226 | 4 x 5 | 5.000 | 50 | 4 x 7 | 3.300 | 70 | 5 x 7 | 1.700 | 110 |
| | | | | | 5 x 5 | 2.600 | 80 | 5 x 5 | 2.600 | 80 |
| 33 | 336 | 5 x 5 | 2.600 | 80 | 5 x 5 | 2.600 | 80 | 6.3 x 5 | 1.300 | 115 |
| | | 5 x 7 | 1.700 | 110 | 5 x 7 | 1.700 | 110 | 6.3 x 7 | 0.800 | 160 |
| 47 | 476 | 5 x 5 | 2.600 | 80 | 6.3 x 5 | 1.300 | 115 | 6.3 x 5 | 1.300 | 115 |
| | | 5 x 7 | 1.700 | 110 | 6.3 x 7 | 0.800 | 160 | 6.3 x 7 | 0.800 | 160 |
| 68 | 686 | 6.3 x 5 | 1.300 | 115 | 6.3 x 7 | 0.800 | 160 | 8 x 7 | 0.500 | 200 |
| | | 6.3 x 7 | 0.800 | 160 | | | | | | |
| 100 | 107 | 6.3 x 5 | 1.300 | 115 | 8 x 7 | 0.500 | 200 | 6.3 x 11 | 0.220 | 340 |
| | | 6.3 x 7 | 0.800 | 160 | | | | 8 x 7 | 0.500 | 200 |
| 120 | 127 | | | | | | | 6.3 x 11 | 0.220 | 340 |
| 150 | 157 | 8 x 7 | 0.500 | 200 | 6.3 x 11 | 0.220 | 340 | 6.3 x 11 | 0.220 | 340 |
| | | | | | 8 x 7 | 0.500 | 200 | 8 x 12 | 0.130 | 640 |
| 180 | 187 | 6.3 x 11 | 0.220 | 340 | 6.3 x 11 | 0.220 | 340 | 6.3 x 11 | 0.220 | 340 |
| | | | | | | | | 8 x 12 | 0.130 | 640 |
| 220 | 227 | 8 x 7 | 0.500 | 200 | 6.3 x 11 | 0.220 | 340 | 6.3 x 11 | 0.220 | 340 |
| | | 6.3 x 11 | 0.220 | 340 | | | | 8 x 12 | 0.130 | 640 |
| 270 | 277 | 6.3 x 11 | 0.220 | 340 | 6.3 x 11 | 0.220 | 340 | 8 x 12 | 0.130 | 640 |
| | | | | | 8 x 12 | 0.130 | 640 | | | |
| 330 | 337 | 6.3 x 11 | 0.220 | 340 | 6.3 x 11 | 0.220 | 340 | 6.3 x 11 | 0.220 | 340 |
| | | 8 x 12 | 0.130 | 640 | 8 x 12 | 0.130 | 640 | 8 x 12 | 0.130 | 640 |
| 390 | 397 | 8 x 12 | 0.130 | 640 | 8 x 12 | 0.130 | 640 | 8 x 12 | 0.130 | 640 |
| 470 | 477 | 8 x 12 | 0.130 | 640 | 6.3 x 11 | 0.220 | 340 | 8 x 12 | 0.130 | 640 |
| | | | | | 8 x 12 | 0.130 | 640 | 10 x 12.5 | 0.080 | 865 |
| 560 | 567 | 8 x 12 | 0.130 | 640 | 8 x 12 | 0.130 | 640 | 10 x 12.5 | 0.080 | 865 |
| 680 | 687 | 8 x 12 | 0.130 | 640 | 8 x 12 | 0.130 | 640 | 8 x 16 | 0.087 | 840 |
| | | | | | | | | 10 x 12.5 | 0.080 | 865 |
| 820 | 827 | 8 x 12 | 0.130 | 640 | 10 x 12.5 | 0.080 | 865 | 10 x 16 | 0.060 | 1210 |
| | | 10 x 12.5 | 0.080 | 865 | | | | | | |
| 1000 | 108 | 8 x 12 | 0.130 | 640 | 8 x 16 | 0.087 | 840 | 8 x 16 | 0.087 | 840 |
| | | 10 x 12.5 | 0.080 | 865 | 10 x 16 | 0.060 | 1210 | 10 x 16 | 0.060 | 1210 |
| 1200 | 128 | 8 x 16 | 0.087 | 840 | 10 x 20 | 0.046 | 1400 | 10 x 20 | 0.046 | 1400 |
| | | 10 x 12.5 | 0.080 | 865 | | | | | | |
| 1500 | 158 | 8 x 20 | 0.069 | 1050 | 10 x 20 | 0.046 | 1400 | 10 x 20 | 0.046 | 1400 |
| | | 10 x 16 | 0.060 | 1210 | | | | | | |
| 1800 | 188 | 10 x 20 | 0.046 | 1400 | 10 x 20 | 0.046 | 1400 | 10 x 25 | 0.042 | 1650 |
| | | | | | | | | 12.5 x 20 | 0.035 | 1900 |
| 2200 | 228 | 10 x 20 | 0.046 | 1400 | 10 x 20 | 0.046 | 1400 | 10 x 25 | 0.042 | 1650 |
| | | | | | | | | 12.5 x 20 | 0.035 | 1900 |
| 2700 | 278 | 10 x 25 | 0.042 | 1650 | 10 x 25 | 0.042 | 1650 | 12.5 x 25 | 0.030 | 2124 |
| | | 12.5 x 20 | 0.035 | 1900 | 12.5 x 20 | 0.035 | 1900 | | | |
| 3300 | 338 | 10 x 25 | 0.042 | 1650 | 12.5 x 25 | 0.030 | 2124 | 12.5 x 25 | 0.030 | 2124 |
| | | 12.5 x 20 | 0.035 | 1900 | | | | | | |
| 3900 | 398 | 12.5 x 20 | 0.035 | 1900 | | | | | | |
| 4700 | 478 | 12.5 x 25 | 0.030 | 2124 | | | | | | |

Maximum Allowable Ripple Current (mArms) at 105°C 100kHz

Case Size Φ D x L (mm)

Maximum Impedance (Ω) at 20°C 100kHz

Specifications are subject to change without notice. Should a safety or technical concern arise regarding the product, please be sure to contact our sales offices or agents immediately.

GF

Miniature Aluminum Electrolytic Capacitors

STANDARD RATINGS

| Voltage (Code) | | 25V (1E) | | | 35V (1V) | | | 50V (1H) | | |
|----------------|------|-----------|-----------|----------------|-----------|-----------|----------------|-----------|-----------|----------------|
| Cap. (µF) | Code | Case Size | Impedance | Ripple Current | Case Size | Impedance | Ripple Current | Case Size | Impedance | Ripple Current |
| 3.3 | 335 | | | | 4 x 5 | 5.000 | 50 | | | |
| 4.7 | 475 | 4 x 5 | 5.000 | 50 | 4 x 5 | 5.000 | 50 | | | |
| 6.8 | 685 | 4 x 5 | 5.000 | 50 | 4 x 7 | 3.300 | 70 | | | |
| | | | | | 5 x 5 | 2.600 | 80 | | | |
| 10 | 106 | 4 x 7 | 3.300 | 70 | 5 x 5 | 2.600 | 80 | | | |
| | | 5 x 5 | 2.600 | 80 | 5 x 7 | 1.700 | 110 | | | |
| 15 | 156 | 5 x 7 | 1.700 | 110 | 6.3 x 5 | 1.300 | 115 | | | |
| | | 6.3 x 5 | 1.300 | 115 | 6.3 x 7 | 0.800 | 160 | | | |
| 22 | 226 | 5 x 7 | 1.700 | 110 | 6.3 x 5 | 1.300 | 115 | | | |
| | | 6.3 x 5 | 1.300 | 115 | 6.3 x 7 | 0.800 | 160 | | | |
| 33 | 336 | 6.3 x 5 | 1.300 | 115 | 8 x 7 | 0.500 | 200 | 6.3 x 11 | 0.300 | 295 |
| | | 6.3 x 7 | 0.800 | 160 | | | | | | |
| 39 | 396 | | | | | | | 6.3 x 11 | 0.300 | 295 |
| 47 | 476 | 8 x 7 | 0.500 | 200 | 6.3 x 11 | 0.220 | 340 | 6.3 x 11 | 0.300 | 295 |
| 56 | 566 | | | | 6.3 x 11 | 0.220 | 340 | 8 x 12 | 0.170 | 555 |
| 68 | 686 | 8 x 7 | 0.500 | 200 | 6.3 x 11 | 0.220 | 340 | 8 x 12 | 0.170 | 555 |
| 82 | 826 | 6.3 x 11 | 0.220 | 340 | 8 x 12 | 0.130 | 640 | 8 x 12 | 0.170 | 555 |
| 100 | 107 | 6.3 x 11 | 0.220 | 340 | 6.3 x 11 | 0.220 | 340 | 10 x 12.5 | 0.120 | 760 |
| | | | | | 8 x 12 | 0.130 | 640 | | | |
| 120 | 127 | 8 x 12 | 0.130 | 640 | 8 x 12 | 0.130 | 640 | 8 x 16 | 0.120 | 730 |
| | | | | | | | | 10 x 12.5 | 0.120 | 760 |
| 150 | 157 | 8 x 12 | 0.130 | 640 | 8 x 12 | 0.130 | 640 | 10 x 16 | 0.084 | 1050 |
| 180 | 187 | 8 x 12 | 0.130 | 640 | 10 x 12.5 | 0.080 | 865 | 8 x 20 | 0.091 | 910 |
| | | | | | | | | 10 x 16 | 0.084 | 1050 |
| 220 | 227 | 8 x 12 | 0.130 | 640 | 8 x 12 | 0.130 | 640 | 8 x 20 | 0.091 | 910 |
| | | | | | 8 x 16 | 0.087 | 840 | | | |
| | | | | | 10 x 12.5 | 0.080 | 865 | | | |
| 270 | 277 | 8 x 12 | 0.130 | 640 | 10 x 16 | 0.060 | 1210 | 10 x 25 | 0.055 | 1440 |
| | | 10 x 12.5 | 0.080 | 865 | | | | | | |
| 330 | 337 | 8 x 12 | 0.130 | 640 | 8 x 16 | 0.087 | 840 | 12.5 x 20 | 0.045 | 1660 |
| | | | | | 8 x 20 | 0.069 | 1050 | | | |
| | | 10 x 12.5 | 0.080 | 865 | 10 x 12.5 | 0.080 | 865 | | | |
| 390 | 397 | 10 x 12.5 | 0.080 | 865 | 10 x 16 | 0.060 | 1210 | 12.5 x 20 | 0.045 | 1660 |
| | | | | | 10 x 16 | 0.060 | 1210 | | | |
| | | 8 x 16 | 0.087 | 840 | 10 x 20 | 0.046 | 1400 | | | |
| 470 | 477 | 10 x 12.5 | 0.080 | 865 | 10 x 20 | 0.046 | 1400 | 12.5 x 25 | 0.034 | 1950 |
| | | 10 x 16 | 0.060 | 1210 | | | | | | |
| 560 | 567 | 10 x 16 | 0.060 | 1210 | 10 x 20 | 0.046 | 1400 | 12.5 x 25 | 0.034 | 1950 |
| 680 | 687 | 10 x 16 | 0.060 | 1210 | 10 x 20 | 0.046 | 1400 | | | |
| | | 10 x 20 | 0.046 | 1400 | 12.5 x 20 | 0.035 | 1900 | | | |
| 820 | 827 | 10 x 20 | 0.046 | 1400 | 10 x 25 | 0.042 | 1650 | | | |
| | | | | | 12.5 x 20 | 0.035 | 1900 | | | |
| 1000 | 108 | 10 x 20 | 0.046 | 1400 | 12.5 x 20 | 0.035 | 1900 | | | |
| | | | | | 12.5 x 25 | 0.030 | 2124 | | | |
| 1200 | 128 | 10 x 20 | 0.046 | 1400 | | | | | | |
| 1500 | 158 | 10 x 25 | 0.042 | 1650 | | | | | | |
| | | 12.5 x 20 | 0.035 | 1900 | | | | | | |
| 1800 | 188 | 12.5 x 25 | 0.030 | 2124 | | | | | | |
| 2200 | 228 | 12.5 x 25 | 0.030 | 2124 | | | | | | |

Maximum Allowable Ripple Current (mArms) at 105°C 100kHz

Case Size Φ D x L (mm)

Maximum Impedance (Ω) at 20°C 100kHz

Specifications are subject to change without notice. Should a safety or technical concern arise regarding the product, please be sure to contact our sales offices or agents immediately.

STANDARD RATINGS

| Voltage (Code) | | 63V (1J) | | | 100V (2A) | | |
|----------------|------|-----------|-----------|----------------|-----------|-----------|----------------|
| Cap. (μF) | Code | Case Size | Impedance | Ripple Current | Case Size | Impedance | Ripple Current |
| 15 | 156 | | | | 6.3 x 11 | 0.960 | 115 |
| 22 | 226 | 6.3 x 11 | 0.960 | 115 | | | |
| 27 | 276 | 6.3 x 11 | 0.960 | 115 | 8 x 12 | 0.504 | 232 |
| 33 | 336 | 6.3 x 11 | 0.960 | 115 | | | |
| 39 | 396 | 8 x 12 | 0.504 | 232 | 8 x 16 | 0.360 | 300 |
| 47 | 476 | 8 x 12 | 0.504 | 232 | 10 x 12.5 | 0.344 | 314 |
| 56 | 566 | 8 x 12 | 0.504 | 232 | 8 x 20 | 0.264 | 362 |
| 68 | 686 | 8 x 12 | 0.504 | 232 | 10 x 16 | 0.248 | 357 |
| 82 | 826 | 10 x 12.5 | 0.344 | 314 | 10 x 20 | 0.168 | 466 |
| 100 | 107 | 8 x 16 | 0.360 | 300 | 10 x 20 | 0.168 | 466 |
| | | 10 x 12.5 | 0.344 | 314 | 12.5 x 20 | 0.128 | 690 |
| 120 | 127 | 8 x 16 | 0.360 | 300 | 12.5 x 20 | 0.128 | 690 |
| | | 10 x 16 | 0.248 | 357 | | | |
| 150 | 157 | 8 x 20 | 0.264 | 362 | | | |
| 180 | 187 | 10 x 20 | 0.168 | 466 | 12.5 x 25 | 0.096 | 922 |
| 220 | 227 | 10 x 16 | 0.248 | 357 | 12.5 x 25 | 0.096 | 922 |
| | | 10 x 20 | 0.168 | 466 | | | |
| 270 | 277 | 12.5 x 20 | 0.128 | 690 | | | |
| 330 | 337 | 12.5 x 20 | 0.128 | 690 | | | |
| 390 | 397 | 12.5 x 25 | 0.096 | 922 | | | |

Maximum Allowable Ripple Current (mArms) at 105°C 100kHz

Case Size Φ D x L (mm)

Maximum Impedance (Ω) at 20°C 100kHz

RIPPLE CURRENT MULTIPLIER

Frequency Coefficient

| Coefficient Cap. (μF) | Freq. (Hz) | 120 | 1k | 10k | 100k |
|--------------------------|------------|------|------|------|------|
| ≤180 | | 0.40 | 0.75 | 0.90 | 1.00 |
| 220~560 | | 0.50 | 0.85 | 0.94 | 1.00 |
| 680~1800 | | 0.60 | 0.87 | 0.95 | 1.00 |
| 2200~3900 | | 0.75 | 0.90 | 0.95 | 1.00 |
| 4700 | | 0.85 | 0.95 | 0.98 | 1.00 |

Specifications are subject to change without notice. Should a safety or technical concern arise regarding the product, please be sure to contact our sales offices or agents immediately.

FEATURES

- Low impedance for high frequency.
- Long life: 3,000~6,000 hours at 105°C.

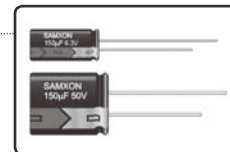

SPECIFICATIONS

| Item | Performance Characteristics |
|---------------------------------|--|
| Operating Temperature Range | -40 to +105°C |
| Rated Working Voltage Range | 6.3 to 100V |
| Nominal Capacitance Range | 15 to 3900µF |
| Capacitance Tolerance | ±20% at 120Hz, +20°C |
| Leakage Current | I ≤ 0.01CV or 3 (µA) whichever is greater measured after 2 minutes application of rated working voltage at +20°C |
| tan δ (120Hz, +20°C) | Working Voltage (V) |
| | tan δ (max.) |
| Low Temperature Characteristics | Impedance ratio max. at 120Hz |
| | Working Voltage (V) |
| | Z-25°C / Z+20°C |
| | Z-40°C / Z+20°C |
| High Temperature Loading | Test time |
| | Test temperature |
| Shelf Life | At +105°C no voltage applied after 1,000 hours and then being stabilized at +20°C the capacitors shall meet the following limits |
| | Leakage current |
| Industrial Standard | JIS C - 5101-4 (IEC 60384-4) |

CASE SIZE TABLE

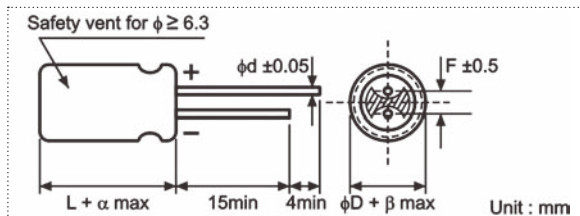

| φD | 6.3 | 8 (L <20) | 8 (L ≥20) | 10 | 12.5 |
|----|-----|-------------|-----------|-------------|------|
| F | 2.5 | 3.5 | 3.5 | 5.0 | 5.0 |
| φd | 0.5 | 0.5 | 0.6 | 0.6 | 0.6 |
| α | | (L <20) 1.5 | | (L ≥20) 2.0 | |
| β | | (D <20) 0.5 | | (D ≥20) 1.0 | |

RIPPLE CURRENT MULTIPLIER

Frequency Coefficient

| Coefficient | 50 | 120 | 300 | 1k | 100k |
|-------------|------|------|------|------|------|
| 15~33 | 0.45 | 0.55 | 0.70 | 0.90 | 1.00 |
| 39~330 | 0.60 | 0.70 | 0.85 | 0.95 | 1.00 |
| 470~1000 | 0.65 | 0.75 | 0.90 | 0.98 | 1.00 |
| 1200~3900 | 0.75 | 0.80 | 0.95 | 1.00 | 1.00 |

PART NUMBER SYSTEM (EXAMPLE : 10V 1500µF)

| | | | | | | | |
|---|-----|-------|---|-----|----|-------|-------|
| 1 | 2 3 | 4 5 6 | 7 | 8 9 | 10 | 11 12 | 13 14 |
| E | SF | 158 | M | 1A | G | 20 | RR |



+105°C, High Ripple Current (高紋波), Long Life Assurance (長壽命), Low Impedance (低阻抗品)

STANDARD RATINGS

| Voltage (Code) | | 6.3V (0J) | | | 10V (1A) | | | 16V (1C) | | |
|----------------|------|-----------|-----------|----------------|-----------|-----------|----------------|-----------|-----------|----------------|
| Cap. (μF) | Code | Case Size | Impedance | Ripple Current | Case Size | Impedance | Ripple Current | Case Size | Impedance | Ripple Current |
| 120 | 127 | | | | | | | 6.3 x 11 | 0.220 | 340 |
| 220 | 227 | | | | 6.3 x 11 | 0.220 | 340 | | | |
| 330 | 337 | 6.3 x 11 | 0.220 | 340 | | | | 8 x 12 | 0.130 | 640 |
| 470 | 477 | | | | 8 x 12 | 0.130 | 640 | 8 x 12 | 0.130 | 640 |
| | | | | | | | | 8 x 16 | 0.087 | 840 |
| | | | | | | | | 10 x 12.5 | 0.080 | 865 |
| 680 | 687 | 8 x 12 | 0.130 | 640 | 8 x 16 | 0.087 | 840 | 8 x 20 | 0.069 | 1050 |
| | | | | | 10 x 12.5 | 0.080 | 865 | 10 x 12.5 | 0.080 | 865 |
| 820 | 827 | 10 x 12.5 | 0.080 | 865 | | | | 10 x 16 | 0.060 | 1210 |
| 1000 | 108 | 8 x 16 | 0.087 | 840 | 8 x 20 | 0.069 | 1050 | 10 x 16 | 0.060 | 1210 |
| | | | | | 10 x 16 | 0.060 | 1210 | 10 x 20 | 0.046 | 1400 |
| 1200 | 128 | 8 x 20 | 0.069 | 1050 | 10 x 20 | 0.046 | 1400 | 10 x 25 | 0.042 | 1650 |
| | | 10 x 16 | 0.060 | 1210 | | | | | | |
| 1500 | 158 | 10 x 20 | 0.046 | 1400 | 10 x 25 | 0.042 | 1650 | 12.5 x 20 | 0.035 | 1900 |
| 2200 | 228 | 10 x 25 | 0.042 | 1650 | 12.5 x 20 | 0.035 | 1900 | 12.5 x 20 | 0.035 | 1900 |
| | | | | | | | | 12.5 x 25 | 0.030 | 2124 |
| 3300 | 338 | 12.5 x 20 | 0.035 | 1900 | 12.5 x 25 | 0.030 | 2124 | | | |
| 3900 | 398 | 12.5 x 25 | 0.030 | 2124 | | | | | | |

Maximum Allowable Ripple Current (mArms) at 105°C 100kHz
Maximum Impedance (Ω) at 20°C 100kHz
Case Size ΦD x L (mm)

| Voltage (Code) | | 25V (1E) | | | 35V (1V) | | | 50V (1H) | | |
|----------------|------|-----------|-----------|----------------|-----------|-----------|----------------|-----------|-----------|----------------|
| Cap. (μF) | Code | Case Size | Impedance | Ripple Current | Case Size | Impedance | Ripple Current | Case Size | Impedance | Ripple Current |
| 56 | 566 | | | | 6.3 x 11 | 0.220 | 340 | 6.3 x 11 | 0.300 | 295 |
| 100 | 107 | 6.3 x 11 | 0.220 | 340 | | | | 8 x 12 | 0.170 | 555 |
| 120 | 127 | | | | | | | 8 x 16 | 0.120 | 730 |
| 150 | 157 | | | | 8 x 12 | 0.130 | 640 | 10 x 12.5 | 0.120 | 760 |
| 220 | 227 | 6.3 x 11 | 0.220 | 340 | 8 x 16 | 0.087 | 840 | 10 x 16 | 0.084 | 1050 |
| | | 8 x 12 | 0.130 | 640 | 10 x 12.5 | 0.080 | 865 | | | |
| 330 | 337 | 8 x 16 | 0.087 | 840 | 10 x 12.5 | 0.080 | 865 | 10 x 25 | 0.055 | 1440 |
| | | 10 x 12.5 | 0.080 | 865 | 10 x 16 | 0.060 | 1210 | | | |
| 470 | 477 | 8 x 20 | 0.069 | 1050 | 10 x 20 | 0.046 | 1400 | 10 x 20 | 0.060 | 1210 |
| | | 10 x 16 | 0.060 | 1210 | | | | 12.5 x 20 | 0.045 | 1660 |
| 560 | 567 | | | | 10 x 25 | 0.042 | 1650 | 12.5 x 25 | 0.034 | 1950 |
| 680 | 687 | 10 x 16 | 0.060 | 1210 | 12.5 x 20 | 0.035 | 1900 | 10 x 30 | 0.043 | 1690 |
| | | 10 x 20 | 0.046 | 1400 | | | | | | |
| 820 | 827 | 10 x 25 | 0.042 | 1650 | | | | | | |
| 1000 | 108 | 12.5 x 20 | 0.035 | 1900 | 12.5 x 20 | 0.035 | 1900 | | | |
| | | | | | 12.5 x 25 | 0.030 | 2124 | | | |
| 1500 | 158 | 12.5 x 25 | 0.030 | 2124 | | | | | | |

Maximum Allowable Ripple Current (mArms) at 105°C 100kHz
Maximum Impedance (Ω) at 20°C 100kHz
Case Size ΦD x L (mm)

| Voltage (Code) | | 63V (1J) | | | 100V (2A) | | |
|----------------|------|-----------|-----------|----------------|-----------|-----------|----------------|
| Cap. (μF) | Code | Case Size | Impedance | Ripple Current | Case Size | Impedance | Ripple Current |
| 15 | 156 | | | | 6.3 x 11 | 0.960 | 115 |
| 27 | 276 | | | | 8 x 12 | 0.504 | 232 |
| 33 | 336 | 6.3 x 11 | 0.960 | 115 | | | |
| 39 | 396 | | | | 8 x 16 | 0.360 | 300 |
| 47 | 476 | | | | 10 x 12.5 | 0.344 | 314 |
| 56 | 566 | 8 x 12 | 0.504 | 232 | 8 x 20 | 0.264 | 362 |
| 68 | 686 | | | | 10 x 16 | 0.248 | 357 |
| 82 | 826 | 8 x 16 | 0.360 | 300 | 10 x 20 | 0.168 | 466 |
| | | 10 x 12.5 | 0.344 | 314 | | | |
| 100 | 107 | | | | 10 x 20 | 0.168 | 466 |
| | | | | | 10 x 25 | 0.160 | 531 |
| 120 | 127 | 8 x 20 | 0.264 | 362 | 12.5 x 20 | 0.128 | 690 |
| | | 10 x 16 | 0.248 | 357 | | | |
| 180 | 187 | 10 x 20 | 0.168 | 466 | 12.5 x 25 | 0.096 | 922 |
| 220 | 227 | 10 x 25 | 0.160 | 531 | | | |
| 270 | 277 | 12.5 x 20 | 0.128 | 690 | | | |
| 330 | 337 | 12.5 x 25 | 0.096 | 922 | | | |

Maximum Allowable Ripple Current (mArms) at 105°C 100kHz
Maximum Impedance (Ω) at 20°C 100kHz
Case Size ΦD x L (mm)

Specifications are subject to change without notice. Should a safety or technical concern arise regarding the product, please be sure to contact our sales offices or agents immediately.

FEATURES

- Low impedance for high frequency.
- Load life of 4,000~10,000 hours at 105°C.



SPECIFICATIONS

| Item | Performance Characteristics | | | | | | | | | |
|---------------------------------|--|--|--------|--------|---------|---|------|------|------|--|
| Operating Temperature Range | -40 to +105°C | | | | | | | | | |
| Rated Working Voltage Range | 6.3 to 100V | | | | | | | | | |
| Nominal Capacitance Range | 15 to 3900µF | | | | | | | | | |
| Capacitance Tolerance | ±20% at 120Hz, +20°C | | | | | | | | | |
| Leakage Current | I ≤ 0.01CV or 3 (µA) | | | | | | | | | |
| | whichever is greater measured after 2 minutes application of rated working voltage at +20°C | | | | | | | | | |
| tan δ (120Hz, +20°C) | Working Voltage (V) | 6.3 | 10 | 16 | 25 | 35 | 50 | 63 | 100 | |
| | tan δ (max.) | 0.22 | 0.19 | 0.16 | 0.14 | 0.12 | 0.10 | 0.09 | 0.08 | |
| | For capacitance value >1000µF, add 0.02 per another 1000µF | | | | | | | | | |
| Low Temperature Characteristics | Impedance ratio max. at 120Hz | | | | | | | | | |
| | Rated Voltage (V) | 6.3 | 10 | 16 | 25 | 35 | 50 | 63 | 100 | |
| | Z-25°C / Z+20°C | 4 | 3 | 2 | 2 | 2 | 2 | 2 | 2 | |
| | Z-40°C / Z+20°C | 8 | 6 | 4 | 3 | 3 | 3 | 3 | 3 | |
| High Temperature Loading | Test time | ΦD | 5-6.3 | 8-10 | 12.5 | Post test requirements at +20°C | | | | |
| | | 6.3-10WV | 4,000h | 6,000h | 8,000h | Leakage current : ≤Initial specified value | | | | |
| | Test temperature | 16-100WV | 5,000h | 7,000h | 10,000h | Cap. change : within ±25% of the initial measured value | | | | |
| | | +105°C | | | | tan δ : ≤200% of the initial specified value | | | | |
| Test conditions | | Rated DC working voltage with rated ripple current | | | | | | | | |
| Shelf Life | At +105°C no voltage applied after 1,000 hours and then being stabilized at +20°C the capacitors shall meet the following limits | | | | | | | | | |
| | Leakage current : ≤Initial specified value | | | | | | | | | |
| | Cap. change : within ±25% of the initial measured value | | | | | | | | | |
| Industrial Standard | tan δ : ≤200% of the initial specified value | | | | | | | | | |
| | JIS C - 5101-4 (IEC 60384-4) | | | | | | | | | |

CASE SIZE TABLE

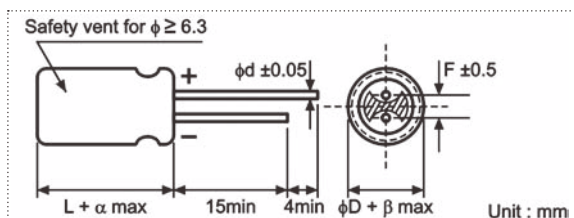

| ΦD | 6.3 | 8 (L <20) | 8 (L ≥20) | 10 | 12.5 |
|----|-------------|-----------|-----------|-------------|------|
| F | 2.5 | 3.5 | 3.5 | 5.0 | 5.0 |
| Φd | 0.5 | 0.5 | 0.6 | 0.6 | 0.6 |
| α | (L <20) 1.5 | | | (L ≥20) 2.0 | |
| β | (D <20) 0.5 | | | (D ≥20) 1.0 | |

RIPPLE CURRENT MULTIPLIER

Frequency Coefficient

| Coefficient | Freq. (Hz) | | | | |
|-------------|------------|------|------|------|------|
| Cap (µF) | 50 | 120 | 300 | 1k | 100k |
| 15~33 | 0.45 | 0.55 | 0.70 | 0.90 | 1.00 |
| 39~330 | 0.60 | 0.70 | 0.85 | 0.95 | 1.00 |
| 390~1000 | 0.65 | 0.75 | 0.90 | 0.98 | 1.00 |
| 1200~3900 | 0.75 | 0.80 | 0.95 | 1.00 | 1.00 |

PART NUMBER SYSTEM (EXAMPLE : 10V 3300µF)

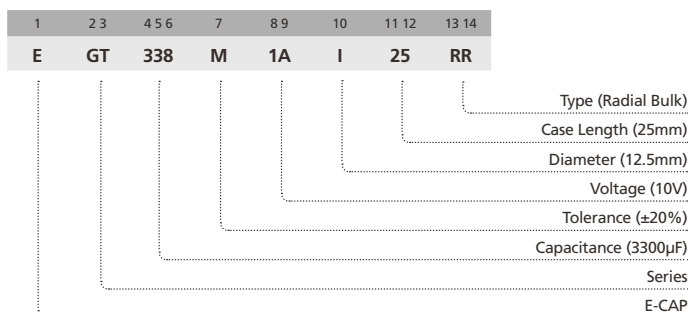

+105°C, High Ripple Current (高紋波), Longer Life Assurance (較長壽命), Low Impedance (低阻抗品)

STANDARD RATINGS

| Voltage (Code) | | 6.3V (0J) | | | 10V (1A) | | | 16V (1C) | | |
|----------------|------|-----------|-----------|----------------|-----------|-----------|----------------|-----------|-----------|----------------|
| Cap. (μF) | Code | Case Size | Impedance | Ripple Current | Case Size | Impedance | Ripple Current | Case Size | Impedance | Ripple Current |
| 120 | 127 | | | | | | | 6.3 x 11 | 0.220 | 340 |
| 220 | 227 | | | | 6.3 x 11 | 0.220 | 340 | 6.3 x 11 | 0.220 | 340 |
| 330 | 337 | 6.3 x 11 | 0.220 | 340 | | | | 8 x 12 | 0.130 | 640 |
| 470 | 477 | | | | 6.3 x 11 | 0.220 | 340 | 8 x 12 | 0.130 | 640 |
| | | | | | 8 x 12 | 0.130 | 640 | 8 x 16 | 0.087 | 840 |
| 680 | 687 | 8 x 12 | 0.130 | 640 | 8 x 16 | 0.087 | 840 | 8 x 16 | 0.087 | 840 |
| | | | | | 10 x 12.5 | 0.080 | 865 | 8 x 20 | 0.069 | 1050 |
| 820 | 827 | 10 x 12.5 | 0.080 | 865 | | | | 10 x 16 | 0.060 | 1210 |
| 1000 | 108 | 8 x 16 | 0.087 | 840 | 8 x 20 | 0.069 | 1050 | 10 x 16 | 0.060 | 1210 |
| | | 10 x 12.5 | 0.080 | 865 | 10 x 16 | 0.060 | 1210 | 10 x 20 | 0.046 | 1400 |
| 1200 | 128 | 8 x 20 | 0.069 | 1050 | 10 x 20 | 0.046 | 1400 | 10 x 20 | 0.046 | 1400 |
| | | 10 x 16 | 0.060 | 1210 | | | | 10 x 25 | 0.042 | 1650 |
| 1500 | 158 | 10 x 20 | 0.046 | 1400 | 10 x 25 | 0.042 | 1650 | 10 x 30 | 0.031 | 1910 |
| | | | | | | | | 12.5 x 20 | 0.035 | 1900 |
| 2200 | 228 | 10 x 25 | 0.042 | 1650 | 10 x 30 | 0.031 | 1910 | 12.5 x 25 | 0.030 | 2124 |
| 2700 | 278 | 10 x 30 | 0.031 | 1910 | | | | | | |
| 3300 | 338 | 12.5 x 20 | 0.035 | 1900 | 12.5 x 25 | 0.030 | 2124 | | | |
| 3900 | 398 | 12.5 x 25 | 0.030 | 2124 | | | | | | |

Maximum Allowable Ripple Current (mArms) at 105°C 100kHz

Case Size Φ D x L (mm)

Maximum Impedance (Ω) at 20°C 100kHz

| Voltage (Code) | | 25V (1E) | | | 35V (1V) | | | 50V (1H) | | |
|----------------|------|-----------|-----------|----------------|-----------|-----------|----------------|-----------|-----------|----------------|
| Cap. (μF) | Code | Case Size | Impedance | Ripple Current | Case Size | Impedance | Ripple Current | Case Size | Impedance | Ripple Current |
| 56 | 566 | | | | 6.3 x 11 | 0.220 | 340 | 6.3 x 11 | 0.300 | 295 |
| 100 | 107 | 6.3 x 11 | 0.220 | 340 | 6.3 x 11 | 0.220 | 340 | 8 x 12 | 0.170 | 555 |
| 120 | 127 | | | | | | | 8 x 16 | 0.120 | 730 |
| 150 | 157 | | | | 8 x 12 | 0.130 | 640 | 10 x 12.5 | 0.120 | 760 |
| | | | | | 8 x 16 | 0.087 | 840 | 8 x 16 | 0.120 | 730 |
| 220 | 227 | 8 x 12 | 0.130 | 640 | 10 x 12.5 | 0.080 | 865 | 10 x 12.5 | 0.120 | 760 |
| | | | | | 10 x 16 | 0.084 | 1050 | 10 x 16 | 0.084 | 1050 |
| 330 | 337 | 8 x 16 | 0.087 | 840 | 10 x 16 | 0.060 | 1210 | 10 x 16 | 0.084 | 1050 |
| | | 10 x 12.5 | 0.080 | 865 | | | | 10 x 25 | 0.055 | 1440 |
| 470 | 477 | 8 x 16 | 0.087 | 840 | | | | 10 x 20 | 0.060 | 1220 |
| | | 8 x 20 | 0.069 | 1050 | 10 x 20 | 0.046 | 1400 | 10 x 30 | 0.043 | 1690 |
| 560 | 567 | 10 x 16 | 0.060 | 1210 | | | | 12.5 x 20 | 0.045 | 1660 |
| | | | | | 10 x 25 | 0.042 | 1650 | 12.5 x 25 | 0.034 | 1950 |
| 680 | 687 | 8 x 20 | 0.069 | 1050 | 10 x 30 | 0.031 | 1910 | 12.5 x 20 | 0.045 | 1660 |
| | | 10 x 20 | 0.046 | 1400 | 12.5 x 20 | 0.035 | 1900 | | | |
| 820 | 827 | 10 x 25 | 0.042 | 1650 | | | | 12.5 x 25 | 0.034 | 1950 |
| | | 10 x 25 | 0.042 | 1650 | | | | | | |
| 1000 | 108 | 10 x 30 | 0.031 | 1910 | 12.5 x 25 | 0.030 | 2124 | 12.5 x 25 | 0.034 | 1950 |
| | | 12.5 x 20 | 0.035 | 1900 | | | | | | |
| 1500 | 158 | 12.5 x 20 | 0.035 | 1900 | | | | | | |
| | | 12.5 x 25 | 0.030 | 2124 | | | | | | |

Maximum Allowable Ripple Current (mArms) at 105°C 100kHz

Case Size Φ D x L (mm)

Maximum Impedance (Ω) at 20°C 100kHz

Specifications are subject to change without notice. Should a safety or technical concern arise regarding the product, please be sure to contact our sales offices or agents immediately.

STANDARD RATINGS

| Voltage (Code) | | 63V (1J) | | | 100V (2A) | | |
|----------------|------|-----------|-----------|----------------|-----------|-----------|----------------|
| Cap. (μF) | Code | Case Size | Impedance | Ripple Current | Case Size | Impedance | Ripple Current |
| 15 | 156 | | | | 6.3 x 11 | 0.960 | 115 |
| 27 | 276 | | | | 8 x 12 | 0.504 | 232 |
| 33 | 336 | 6.3 x 11 | 0.960 | 115 | | | |
| 39 | 396 | | | | 8 x 16 | 0.360 | 300 |
| 47 | 476 | | | | 10 x 12.5 | 0.344 | 314 |
| 56 | 566 | 8 x 12 | 0.504 | 232 | 8 x 20 | 0.264 | 362 |
| 68 | 686 | 8 x 12 | 0.504 | 232 | 10 x 16 | 0.248 | 357 |
| 82 | 826 | 8 x 16 | 0.360 | 300 | 10 x 20 | 0.168 | 466 |
| | | 10 x 12.5 | 0.344 | 314 | | | |
| 100 | 107 | | | | 10 x 20 | 0.168 | 466 |
| | | | | | 10 x 25 | 0.160 | 531 |
| 120 | 127 | 8 x 20 | 0.264 | 362 | 10 x 30 | 0.120 | 663 |
| | | 10 x 16 | 0.248 | 357 | 12.5 x 20 | 0.128 | 690 |
| 180 | 187 | 10 x 20 | 0.168 | 466 | 12.5 x 25 | 0.096 | 922 |
| 220 | 227 | 10 x 25 | 0.160 | 531 | | | |
| 270 | 277 | 10 x 20 | 0.168 | 466 | | | |
| | | 10 x 30 | 0.120 | 663 | | | |
| | | 12.5 x 20 | 0.128 | 690 | | | |
| 330 | 337 | 12.5 x 20 | 0.128 | 690 | | | |
| | | 12.5 x 25 | 0.096 | 922 | | | |
| 470 | 477 | 12.5 x 25 | 0.096 | 922 | | | |

Maximum Allowable Ripple Current (mArms) at 105°C 100kHz

Case Size ϕ D x L (mm)

Maximum Impedance (Ω) at 20°C 100kHz

FEATURES

- Load life of 2,000~5,000 hours at 105°C.
- Enabled high ripple current by a reduction of impedance at high frequency range.
- Lowest impedance for personal computer and storage equipment.



SPECIFICATIONS

| Item | Performance Characteristics | | | | | |
|--|--|------|--------|--------|--------|--------|
| Operating Temperature Range | -40 to +105°C | | | | | |
| Rated Working Voltage Range | 6.3 to 25V | | | | | |
| Nominal Capacitance Range | 100 to 3900µF | | | | | |
| Capacitance Tolerance | ±20% at 120Hz, +20°C | | | | | |
| Leakage Current | I ≤ 0.01CV or 3 (µA) whichever is greater measured after 2 minutes application of rated working voltage at +20°C | | | | | |
| tan δ (120Hz, +20°C) | Working Voltage (V) | 6.3 | 10 | 16 | 25 | |
| | tan δ (max.) | 0.22 | 0.19 | 0.16 | 0.14 | |
| For capacitance value >1000µF, add 0.02 per another 1000µF | | | | | | |
| Low Temperature Characteristics | Impedance ratio max. at 120Hz | | | | | |
| | Working Voltage (V) | 6.3 | 10 | 16 | 25 | |
| Z-25°C / Z+20°C | | | | | | |
| High Temperature Loading | Test time | ΦD | 6.3 | 8 | 10 | 12.5 |
| | Load life | | 2,000h | 3,000h | 4,000h | 5,000h |
| | Test temperature | | +105°C | | | |
| Test conditions : Rated DC working voltage with rated ripple current | | | | | | |
| Post test requirements at +20°C | | | | | | |
| Leakage current : ≤ Initial specified value | | | | | | |
| Cap. change : within ±25% of the initial measured value | | | | | | |
| tan δ : ≤ 200% of the initial specified value | | | | | | |
| Shelf Life | At +105°C no voltage applied after 1,000 hours and then being stabilized at +20°C the capacitors shall meet the following limits | | | | | |
| Leakage current : ≤ Initial specified value | | | | | | |
| Cap. change : within ±25% of the initial measured value | | | | | | |
| tan δ : ≤ 200% of the initial specified value | | | | | | |
| Industrial Standard | JIS C - 5101-4 (IEC 60384-4) | | | | | |

CASE SIZE TABLE



| ΦD | 6.3 | 8 (L < 20) | 8 (L ≥ 20) | 10 | 12.5 |
|----|--------------|------------|--------------|-----|------|
| F | 2.5 | 3.5 | 3.5 | 5.0 | 5.0 |
| Φd | 0.5 | 0.5 | 0.6 | 0.6 | 0.6 |
| α | (L < 20) 1.5 | | (L ≥ 20) 2.0 | | |
| β | (D < 20) 0.5 | | (D ≥ 20) 1.0 | | |

RIPPLE CURRENT MULTIPLIER

Frequency Coefficient

| Coefficient | 120 | 1k | 10k | 100k |
|-------------|------|------|------|------|
| Cap (µF) | | | | |
| 100~180 | 0.40 | 0.75 | 0.90 | 1.00 |
| 220~560 | 0.50 | 0.85 | 0.94 | 1.00 |
| 680~1800 | 0.60 | 0.87 | 0.95 | 1.00 |
| 2200~3900 | 0.75 | 0.90 | 0.95 | 1.00 |

PART NUMBER SYSTEM (EXAMPLE : 25V 220µF)

| | | | | | | | |
|---|----|-----|---|----|----|-------|-------|
| 1 | 23 | 456 | 7 | 89 | 10 | 11 12 | 13 14 |
| E | GK | 227 | M | 1E | F | 12 | RR |



STANDARD RATINGS

| Voltage (Code) | | 6.3V (0J) | | | 10V (1A) | | | 16V (1C) | | |
|----------------|------|-----------|-----------|----------------|-----------|-----------|----------------|-----------|-----------|----------------|
| Cap. (µF) | Code | Case Size | Impedance | Ripple Current | Case Size | Impedance | Ripple Current | Case Size | Impedance | Ripple Current |
| 120 | 127 | | | | | | | 6.3 x 11 | 0.130 | 405 |
| 220 | 227 | 6.3 x 11 | 0.130 | 405 | 6.3 x 11 | 0.130 | 405 | 8 x 12 | 0.072 | 760 |
| 330 | 337 | 6.3 x 11 | 0.130 | 405 | 8 x 12 | 0.072 | 760 | 8 x 12 | 0.072 | 760 |
| 470 | 477 | 8 x 12 | 0.072 | 760 | 8 x 12 | 0.072 | 760 | 8 x 16 | 0.056 | 995 |
| 560 | 567 | 8 x 12 | 0.072 | 760 | | | | 10 x 12.5 | 0.053 | 1030 |
| 680 | 687 | | | | 8 x 16 | 0.056 | 995 | 8 x 20 | 0.041 | 1250 |
| | | | | | 10 x 12.5 | 0.053 | 1030 | 10 x 16 | 0.038 | 1430 |
| 820 | 827 | 8 x 16 | 0.056 | 995 | | | | | | |
| 1000 | 108 | 10 x 12.5 | 0.053 | 1030 | 8 x 20 | 0.041 | 1250 | 10 x 20 | 0.023 | 1820 |
| | | | | | 10 x 16 | 0.038 | 1430 | | | |
| 1200 | 128 | 8 x 20 | 0.041 | 1250 | 10 x 20 | 0.023 | 1820 | 10 x 25 | 0.022 | 2150 |
| | | 10 x 16 | 0.038 | 1430 | | | | | | |
| 1500 | 158 | 10 x 20 | 0.023 | 1820 | 10 x 25 | 0.022 | 2150 | 12.5 X 20 | 0.021 | 2360 |
| 2200 | 228 | 10 x 25 | 0.022 | 2150 | 12.5 x 20 | 0.021 | 2360 | 12.5 X 25 | 0.018 | 2770 |
| 3300 | 338 | 12.5 x 20 | 0.021 | 2360 | 12.5 x 25 | 0.018 | 2770 | | | |
| 3900 | 398 | 12.5 x 25 | 0.018 | 2770 | | | | | | |

Maximum Allowable Ripple Current (mArms) at 105°C 100kHz

Case Size Φ D x L (mm)

Maximum Impedance (Ω) at 20°C 100kHz

| Voltage (Code) | | 25V (1E) | | |
|----------------|------|-----------|-----------|----------------|
| Cap. (µF) | Code | Case Size | Impedance | Ripple Current |
| 100 | 107 | 6.3 x 11 | 0.130 | 405 |
| 220 | 227 | 8 x 12 | 0.072 | 760 |
| 330 | 337 | 8 x 16 | 0.056 | 995 |
| | | 10 x 12.5 | 0.053 | 1030 |
| 470 | 477 | 8 x 20 | 0.041 | 1250 |
| | | 10 x 16 | 0.038 | 1430 |
| 680 | 687 | 10 x 20 | 0.023 | 1820 |
| 820 | 827 | 10 x 25 | 0.022 | 2150 |
| 1000 | 108 | 12.5 x 20 | 0.021 | 2360 |
| 1500 | 158 | 12.5 x 25 | 0.018 | 2770 |

Maximum Allowable Ripple Current (mArms) at 105°C 100kHz

Case Size Φ D x L (mm)

Maximum Impedance (Ω) at 20°C 100kHz

Specifications are subject to change without notice. Should a safety or technical concern arise regarding the product, please be sure to contact our sales offices or agents immediately.

FEATURES

- Load life of 5,000~6,000 hours at 105°C.
- Enabled high ripple current by a reduction of impedance at high frequency range.
- Lowest impedance for personal computer and storage equipment.



SPECIFICATIONS

| Item | Performance Characteristics | | | | | | | |
|--|--|----------|--------|--|---|---|------|---|
| Operating Temperature Range | -40 to +105°C | | | | | | | |
| Rated Working Voltage Range | 6.3 to 50V | | | | | | | |
| Nominal Capacitance Range | 100 to 8200µF | | | | | | | |
| Capacitance Tolerance | ±20% at 120Hz, +20°C | | | | | | | |
| Leakage Current | I ≤ 0.01CV or 3 (µA) whichever is greater measured after 2 minutes application of rated working voltage at +20°C | | | | | | | |
| tan δ (120Hz, +20°C) | Working Voltage (V) | 6.3 | 10 | 16 | 25 | 35 | 50 | |
| | tan δ (max.) | 0.22 | 0.19 | 0.16 | 0.14 | 0.12 | 0.10 | |
| For capacitance value >1000µF, add 0.02 per another 1000µF | | | | | | | | |
| Low Temperature Characteristics | Impedance ratio max. at 120Hz | | | | | | | |
| | Working Voltage (V) | 6.3 | 10 | 16 | 25 | 35 | 50 | |
| Z-25°C / Z+20°C | | | | | | | | |
| High Temperature Loading | Test time | ΦD | 6.3 | 8~16 | Post test requirements at +20°C | | | |
| | Load life | | 5,000h | 6,000h | Leakage current : ≤ Initial specified value | | | |
| | Test temperature | : +105°C | | | | Cap. change : within ±25% of the initial measured value (6.3, 10V: within ±30%) | | |
| Test conditions | | | | : Rated DC working voltage with rated ripple current | | tan δ | | : ≤ 200% of the initial specified value |
| Shelf Life | At +105°C no voltage applied after 1,000 hours and then being stabilized at +20°C the capacitors shall meet the following limits | | | | | | | |
| | Leakage current : ≤ Initial specified value | | | | | | | |
| | Cap. change : within ±25% of the initial measured value (6.3, 10V: within ±30%) | | | | | | | |
| tan δ : ≤ 200% of the initial specified value | | | | | | | | |
| Industrial Standard | JIS C - 5101-4 (IEC 60384-4) | | | | | | | |

CASE SIZE TABLE



| ΦD | 6.3 | 8 (L < 20) | 8 (L ≥ 20) | 10 | 12.5 | 16 |
|----|--------------|------------|------------|--------------|------|-----|
| F | 2.5 | 3.5 | 3.5 | 5.0 | 5.0 | 7.5 |
| Φd | 0.5 | 0.5 | 0.6 | 0.6 | 0.6 | 0.8 |
| α | (L < 20) 1.5 | | | (L ≥ 20) 2.0 | | |
| β | (D < 20) 0.5 | | | (D ≥ 20) 1.0 | | |

RIPPLE CURRENT MULTIPLIER

Frequency Coefficient

| Coefficient | Freq. (Hz) | | | |
|-------------|------------|------|------|------|
| | 120 | 1k | 10k | 100k |
| Cap (µF) | | | | |
| 100~180 | 0.40 | 0.75 | 0.90 | 1.00 |
| 220~560 | 0.50 | 0.85 | 0.94 | 1.00 |
| 680~1800 | 0.60 | 0.87 | 0.95 | 1.00 |
| 2200~3900 | 0.75 | 0.90 | 0.95 | 1.00 |
| 4700~8200 | 0.85 | 0.95 | 0.98 | 1.00 |

PART NUMBER SYSTEM (EXAMPLE : 16V 1000µF)

| | | | | | | | |
|---|----|-----|---|----|----|------|------|
| 1 | 23 | 456 | 7 | 89 | 10 | 1112 | 1314 |
| E | SH | 108 | M | 1C | G | 16 | RR |



STANDARD RATINGS

| Voltage (Code) | | 6.3V (0J) | | | 10V (1A) | | | 16V (1C) | | |
|----------------|------|-----------|-----------|----------------|-----------|-----------|----------------|-----------|-----------|----------------|
| Cap. (µF) | Code | Case Size | Impedance | Ripple Current | Case Size | Impedance | Ripple Current | Case Size | Impedance | Ripple Current |
| 220 | 227 | | | | | | | 6.3 x 11 | 0.110 | 500 |
| 330 | 337 | | | | 6.3 x 11 | 0.110 | 500 | | | |
| 470 | 477 | 6.3 x 11 | 0.110 | 500 | | | | 8 x 12 | 0.062 | 900 |
| 680 | 687 | | | | 8 x 12 | 0.062 | 900 | 8 x 16 | 0.048 | 1210 |
| | | | | | | | | 10 x 12.5 | 0.045 | 1240 |
| 820 | 827 | 8 x 12 | 0.062 | 900 | | | | | | |
| 1000 | 108 | | | | 8 x 16 | 0.048 | 1210 | 8 x 20 | 0.033 | 1410 |
| | | | | | 10 x 12.5 | 0.045 | 1240 | 10 x 16 | 0.032 | 1650 |
| 1200 | 128 | 8 x 16 | 0.048 | 1210 | | | | | | |
| | | 10 x 12.5 | 0.045 | 1240 | | | | | | |
| 1500 | 158 | 8 x 20 | 0.033 | 1410 | 8 x 20 | 0.033 | 1410 | | 0.020 | 1960 |
| | | | | | 10 x 16 | 0.032 | 1650 | 10 x 20 | | |
| | | | | | | 0.032 | 1760* | | 0.028 | 2500* |
| 1800 | 188 | 10 x 16 | 0.032 | 1650 | 10 x 20 | 0.020 | 1960 | 10 x 25 | 0.018 | 2250 |
| 2200 | 228 | 10 x 20 | 0.020 | 1960 | 10 x 25 | 0.018 | 2250 | 12.5 x 20 | 0.017 | 2480 |
| 2700 | 278 | 10 x 25 | 0.018 | 2250 | | | | 12.5 x 25 | 0.015 | 2900 |
| 3300 | 338 | | | | 12.5 x 20 | 0.017 | 2480 | 12.5 x 30 | 0.013 | 3450 |
| | | | | | | | | 16 x 20 | 0.015 | 3250 |
| 3900 | 398 | 12.5 x 20 | 0.017 | 2480 | 12.5 x 25 | 0.015 | 2900 | 12.5 x 35 | 0.012 | 3570 |
| 4700 | 478 | 12.5 x 25 | 0.015 | 2900 | 12.5 x 30 | 0.013 | 3450 | | | |
| | | | | | 16 x 20 | 0.015 | 3250 | 16 x 25 | 0.013 | 3630 |
| 5600 | 568 | 12.5 x 30 | 0.013 | 3450 | 12.5 x 35 | 0.012 | 3570 | | | |
| 6800 | 688 | 12.5 x 35 | 0.012 | 3570 | | | | | | |
| | | 16 x 20 | 0.015 | 3250 | 16 x 25 | 0.013 | 3630 | | | |
| 8200 | 828 | 16 x 25 | 0.013 | 3630 | | | | | | |

Maximum Allowable Ripple Current (mArms) at 105°C 100kHz

Case Size Φ D x L (mm)

Maximum Impedance (Ω) at 20°C 100kHz

| Voltage (Code) | | 25V (1E) | | | 35V (1V) | | | 50V (1H) | | |
|----------------|------|-----------|-----------|----------------|-----------|-----------|----------------|-----------|-----------|----------------|
| Cap. (µF) | Code | Case Size | Impedance | Ripple Current | Case Size | Impedance | Ripple Current | Case Size | Impedance | Ripple Current |
| 100 | 107 | 6.3 x 11 | 0.110 | 500 | 6.3 x 11 | 0.110 | 500 | 8 x 12 | 0.074 | 724 |
| 150 | 157 | 6.3 x 11 | 0.110 | 500 | | | | 10 x 12.5 | 0.061 | 979 |
| 220 | 227 | | | | 8 x 12 | 0.062 | 900 | 10 x 16 | 0.042 | 1370 |
| 330 | 337 | 8 x 12 | 0.062 | 900 | 10 x 12.5 | 0.045 | 1240 | 10 x 20 | 0.028 | 1870 |
| 390 | 397 | 8 x 16 | 0.048 | 1210 | 8 x 20 | 0.033 | 1410 | | | |
| 470 | 477 | 10 x 12.5 | 0.045 | 1240 | 10 x 16 | 0.032 | 1650 | 12.5 x 20 | 0.027 | 2050 |
| 560 | 567 | 8 x 20 | 0.033 | 1410 | 10 x 20 | 0.020 | 1960 | 12.5 x 25 | 0.023 | 2410 |
| 680 | 687 | 10 x 16 | 0.032 | 1650 | | | | | | |
| | | | 0.032 | 1760* | 10 x 20 | 0.020 | 1960 | 12.5 x 30 | 0.021 | 2860 |
| 820 | 827 | 10 x 20 | 0.020 | 1960* | | | | | | |
| 1000 | 108 | | | | 12.5 x 20 | 0.017 | 2480 | | | |
| 1200 | 128 | 10 x 25 | 0.018 | 2250 | 12.5 x 25 | 0.015 | 2900 | 16 x 25 | 0.021 | 3010 |
| 1500 | 158 | 12.5 x 20 | 0.017 | 2480 | | | | | | |
| 1800 | 188 | 12.5 x 25 | 0.015 | 2900 | | | | | | |
| 2200 | 228 | 12.5 x 30 | 0.013 | 3450 | | | | | | |
| | | 16 x 20 | 0.015 | 3250 | 16 x 25 | 0.013 | 3630 | | | |
| 2700 | 278 | 12.5 x 35 | 0.012 | 3570 | | | | | | |
| 3300 | 338 | 16 x 25 | 0.013 | 3630 | | | | | | |

Maximum Allowable Ripple Current (mArms) at 105°C 100kHz

Case Size Φ D x L (mm)

Maximum Impedance (Ω) at 20°C 100kHz

* Special item with higher ripple current & longer life of 10,000 hrs.

Specifications are subject to change without notice. Should a safety or technical concern arise regarding the product, please be sure to contact our sales offices or agents immediately.

+105°C, Highest Ripple Current (更高紋波), Longest Life Assurance (更長壽命), Lower Impedance (較低阻抗)

FEATURES

- Higher ripple current than GT series and Lower Impedance than GY series.
- Load life of 6,000~10,000 hours at 105°C.
- Enabled high ripple current by a reduction of impedance at high frequency range.
- Lowest impedance for personal computer and storage equipment.



SPECIFICATIONS

| Item | Performance Characteristics | | | | | | | | | |
|---------------------------------|--|---|--------|---------|---------|---|------|------|------|------|
| Operating Temperature Range | -40 to +105°C | | | | | | | | | |
| Rated Working Voltage Range | 6.3 to 100V | | | | | | | | | |
| Nominal Capacitance Range | 33 to 8200µF | | | | | | | | | |
| Capacitance Tolerance | ±20% at 120Hz, +20°C | | | | | | | | | |
| Leakage Current | I ≤ 0.01CV or 3(µA) whichever is greater measured after 2 minutes application of rated working voltage at +20°C | | | | | | | | | |
| tan δ (120Hz, +20°C) | Working Voltage (V) | 6.3 | 10 | 16 | 25 | 35 | 50 | 63 | 80 | 100 |
| | tan δ (max.) | 0.22 | 0.19 | 0.16 | 0.14 | 0.12 | 0.10 | 0.09 | 0.08 | 0.08 |
| | For capacitance > 1000µF, add 0.02 per another 1000µF | | | | | | | | | |
| Low Temperature Characteristics | Impedance ratio max. at 120Hz | | | | | | | | | |
| | Working Voltage (V) | 6.3 | 10 | 16 | 25 | 35 | 50 | 63 | 80 | 100 |
| | Z-25°C / Z+20°C | 2 | 2 | 2 | 2 | 2 | 2 | 2 | 2 | 2 |
| High Temperature Loading | Test time | ΦD | 6.3V | 10-50V | 63-100V | Post test requirements at +20°C | | | | |
| | | ≤6.3 | 6,000h | 7,000h | 6,000h | Leakage current : ≤Initial specified value | | | | |
| | | 8 x 12 | 8,000h | 9,000h | 8,000h | Cap. change : within ±25% of the initial measured value (6.3, 10V: within ±30%) | | | | |
| | | 10 x 12.5 | 9,000h | 9,000h | 9,000h | tan δ : ≤200% of the initial specified value | | | | |
| | | 8 x 16, 8 x 20 | 9,000h | 10,000h | 9,000h | | | | | |
| | 10 x 16, 10 x 20, 10 x 25, ≥12.5 | 10,000h | | | | | | | | |
| | Test temperature | : +105°C | | | | | | | | |
| | Test conditions | : Rated DC working voltage with rated ripple current | | | | | | | | |
| Shelf Life | At +105°C no voltage applied after 1,000 hours and then being stabilized at +20°C the capacitors shall meet the following limits | | | | | | | | | |
| | Leakage current | : ≤Initial specified value | | | | | | | | |
| | Cap. change | : within ±25% of the initial measured value (6.3, 10V: within ±30%) | | | | | | | | |
| | tan δ | : ≤200% of the initial specified value | | | | | | | | |
| Industrial Standard | JIS C - 5101-4 (IEC 60384-4) | | | | | | | | | |

CASE SIZE TABLE



| ΦD | 5 | 6.3 | 8(L<20) | 8(L≥20) | 10 | 12.5 | 16 | 18 |
|----|--------------|-----|---------|---------|--------------|------|-----|-----|
| F | 2.0 | 2.5 | 3.5 | 3.5 | 5.0 | 5.0 | 7.5 | 7.5 |
| Φd | 0.5 | 0.5 | 0.5 | 0.6 | 0.6 | 0.6 | 0.8 | 0.8 |
| α | (L < 20) 1.5 | | | | (L ≥ 20) 2.0 | | | |
| β | (D < 20) 0.5 | | | | (D ≥ 20) 1.0 | | | |

RIPPLE CURRENT MULTIPLIER

Frequency Coefficient

| Coefficient | Freq. (Hz) | 120 | 1K | 10K | 100K |
|-------------|------------|------|------|------|------|
| Cap (µF) | 33~270 | 0.50 | 0.73 | 0.92 | 1.00 |
| | 330~680 | 0.55 | 0.77 | 0.94 | 1.00 |
| | 820~1800 | 0.60 | 0.80 | 0.96 | 1.00 |
| | 2200~8200 | 0.70 | 0.85 | 0.98 | 1.00 |

PART NUMBER SYSTEM (EXAMPLE : 16V 1000µF)

| | | | | | | | |
|---|-----|-------|---|-----|----|-------|-------|
| 1 | 2 3 | 4 5 6 | 7 | 8 9 | 10 | 11 12 | 13 14 |
| E | SK | 108 | M | 1C | G | 16 | RR |

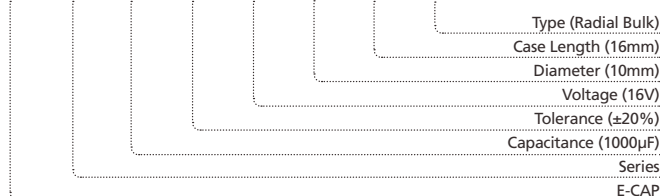

STANDARD RATINGS

| Voltage (Code) | | 6.3V (0J) | | | 10V (1A) | | | 16V (1C) | | |
|----------------|------|-----------|-----------|----------------|-----------|-----------|----------------|-----------|-----------|----------------|
| Cap. (µF) | Code | Case Size | Impedance | Ripple Current | Case Size | Impedance | Ripple Current | Case Size | Impedance | Ripple Current |
| 270 | 277 | | | | | | | 6.3 x 12 | 0.170 | 700 |
| 330 | 337 | | | | 6.3 x 12 | 0.170 | 700 | | | |
| 470 | 477 | 6.3 x 12 | 0.170 | 540 | | | | 8 x 12 | 0.075 | 1200 |
| 560 | 567 | | | | 8 x 12 | 0.075 | 1200 | 8 x 16 | 0.059 | 1600 |
| 680 | 687 | | | | 8 x 16 | 0.059 | 1600 | 10 x 12.5 | 0.053 | 1700 |
| 820 | 827 | 8 x 12 | 0.075 | 945 | 10 x 12.5 | 0.053 | 1700 | 8 x 20 | 0.041 | 1960 |
| 1000 | 108 | 8 x 16 | 0.059 | 1250 | 8 x 20 | 0.041 | 1960 | 10 x 16 | 0.038 | 2000 |
| 1200 | 128 | 10 x 12.5 | 0.053 | 1330 | 10 x 16 | 0.038 | 2000 | | | |
| 1500 | 158 | 8 x 20 | 0.041 | 1500 | | | | 10 x 20 | 0.028 | 2500 |
| 1800 | 188 | 10 x 16 | 0.038 | 1760 | 10 x 20 | 0.028 | 2500 | 10 x 25 | 0.024 | 2900 |
| 2200 | 228 | | | | 10 x 25 | 0.024 | 2900 | 12.5 x 20 | 0.025 | 2600 |
| 2700 | 278 | 10 x 20 | 0.028 | 1960 | 12.5 x 20 | 0.025 | 2600 | 12.5 x 25 | 0.019 | 3200 |
| 3300 | 338 | 10 x 25 | 0.024 | 2250 | 12.5 x 25 | 0.019 | 3200 | 12.5 x 30 | 0.018 | 3660 |
| | | | | | | | | 16 x 20 | 0.021 | 3330 |
| 3900 | 398 | 12.5 x 20 | 0.025 | 2480 | | | | 12.5 x 35 | 0.016 | 4120 |
| | | | | | | | | | | |
| 4700 | 478 | 12.5 x 25 | 0.019 | 2900 | 12.5 x 30 | 0.018 | 3660 | 16 x 25 | 0.017 | 3810 |
| | | | | | 16 x 20 | 0.021 | 3330 | | | |
| 5600 | 568 | 12.5 x 30 | 0.018 | 3450 | 12.5 x 35 | 0.016 | 4120 | | | |
| | | | | | 16 x 25 | 0.017 | 3810 | | | |
| 6800 | 688 | 16 x 20 | 0.021 | 3250 | | | | | | |
| | | 12.5 x 35 | 0.016 | 3570 | | | | | | |
| 8200 | 828 | 16 x 25 | 0.017 | 3630 | | | | | | |

Maximum Allowable Ripple Current (mArms) at 105°C 100kHz

Case Size Φ D x L (mm)

Maximum Impedance (Ω) at 20°C 100kHz



STANDARD RATINGS

| Voltage (Code) | | 25V (1E) | | | 35V (1V) | | | 50V (1H) | | |
|----------------|------|-----------|-----------|----------------|-----------|-----------|----------------|-----------|-----------|----------------|
| Cap. (µF) | Code | Case Size | Impedance | Ripple Current | Case Size | Impedance | Ripple Current | Case Size | Impedance | Ripple Current |
| 56 | 566 | | | | | | | 6.3 x 12 | 0.220 | 500 |
| 100 | 107 | | | | 6.3 x 12 | 0.170 | 700 | 8 x 12 | 0.120 | 950 |
| 120 | 127 | | | | | | | 8 x 16 | 0.082 | 1230 |
| 150 | 157 | 6.3 x 12 | 0.170 | 700 | | | | 10 x 12.5 | 0.073 | 1280 |
| 180 | 187 | | | | 8 x 12 | 0.075 | 1200 | 8 x 20 | 0.058 | 1580 |
| 220 | 227 | | | | 8 x 16 | 0.059 | 1600 | 10 x 16 | 0.053 | 1650 |
| 270 | 277 | | | | 10 x 12.5 | 0.053 | 1700 | | | |
| 330 | 337 | 8 x 12 | 0.075 | 1200 | 8 x 20 | 0.041 | 1960 | 10 x 20 | 0.038 | 2060 |
| 390 | 397 | 8 x 16 | 0.059 | 1600 | 10 x 16 | 0.038 | 2000 | 10 x 25 | 0.032 | 2420 |
| 470 | 477 | 10 x 12.5 | 0.053 | 1700 | | | | 12.5 x 20 | 0.032 | 2300 |
| 560 | 567 | 8 x 20 | 0.041 | 1960 | 10 x 20 | 0.028 | 2500 | | | |
| 680 | 687 | 10 x 16 | 0.038 | 2000 | 10 x 25 | 0.024 | 2900 | 12.5 x 25 | 0.025 | 2800 |
| 820 | 827 | | | | 12.5 x 20 | 0.025 | 2600 | 12.5 x 30 | 0.023 | 3370 |
| | | | | | | | | 16 x 20 | 0.026 | 3070 |
| 1000 | 108 | 10 x 20 | 0.028 | 2500 | | | | 12.5 x 35 | 0.021 | 3810 |
| | | | | | | | | 16 x 25 | 0.022 | 3510 |
| 1200 | 128 | 10 x 25 | 0.024 | 2900 | 12.5 x 25 | 0.019 | 3200 | | | |
| 1500 | 158 | 12.5 x 20 | 0.025 | 2600 | 12.5 x 30 | 0.018 | 3660 | | | |
| | | | | | 16 x 20 | 0.021 | 3330 | | | |
| 1800 | 188 | 12.5 x 25 | 0.019 | 3200 | 12.5 x 35 | 0.016 | 4120 | | | |
| | | | | | 16 x 25 | 0.017 | 3810 | | | |
| 2200 | 228 | 16 x 20 | 0.021 | 3330 | | | | | | |
| | | 12.5 x 30 | 0.018 | 3660 | | | | | | |
| 2700 | 278 | 12.5 x 35 | 0.016 | 4120 | | | | | | |
| 3300 | 338 | 16 x 25 | 0.017 | 3810 | | | | | | |

Maximum Allowable Ripple Current (mArms) at 105°C 100kHz

Case Size ΦD x L (mm)

Maximum Impedance (Ω) at 20°C 100kHz

Specifications are subject to change without notice. Should a safety or technical concern arise regarding the product, please be sure to contact our sales offices or agents immediately.

STANDARD RATINGS

| Voltage (Code) | | 63V (1J) | | | 80V (1K) | | | 100V (2A) | | |
|----------------|------|-----------|-----------|----------------|-----------|-----------|----------------|-----------|-----------|----------------|
| Cap. (µF) | Code | Case Size | Impedance | Ripple Current | Case Size | Impedance | Ripple Current | Case Size | Impedance | Ripple Current |
| 33 | 336 | | | | | | | 8 x 12 | 0.290 | 620 |
| 47 | 476 | | | | 8 x 12 | 0.290 | 620 | 8 x 16 | 0.200 | 780 |
| 56 | 566 | | | | 8 x 16 | 0.200 | 780 | 10 x 12.5 | 0.170 | 780 |
| 68 | 686 | | | | 10 x 12.5 | 0.170 | 780 | 8 x 20 | 0.160 | 1040 |
| 82 | 826 | 8 x 12 | 0.180 | 720 | 8 x 20 | 0.160 | 1040 | 10 x 16 | 0.110 | 1040 |
| 100 | 107 | 8 x 16 | 0.130 | 990 | 10 x 16 | 0.110 | 1040 | 10 x 20 | 0.084 | 1430 |
| | | | | | | | | 12.5 x 16 | 0.110 | 1430 |
| 120 | 127 | 10 x 12.5 | 0.110 | 990 | | | | 10 x 25 | 0.069 | 1620 |
| 150 | 157 | 8 x 20 | 0.096 | 1200 | 10 x 20 | 0.084 | 1430 | 12.5 x 20 | 0.062 | 1750 |
| | | | | | 12.5 x 16 | 0.110 | 1430 | | | |
| 180 | 187 | 10 x 16 | 0.076 | 1200 | 10 x 25 | 0.069 | 1620 | | | |
| 220 | 227 | | | | 12.5 x 20 | 0.062 | 1750 | 12.5 x 25 | 0.047 | 2210 |
| 270 | 277 | 10 x 20 | 0.056 | 1570 | 12.5 x 25 | 0.047 | 2210 | 12.5 x 30 | 0.042 | 2400 |
| | | 12.5 x 16 | 0.072 | 1570 | | | | 16 x 20 | 0.048 | 1950 |
| 330 | 337 | 10 x 25 | 0.046 | 1990 | 12.5 x 30 | 0.042 | 2400 | 12.5 x 35 | 0.036 | 2600 |
| | | | | | 16 x 20 | 0.048 | 1950 | | | |
| 390 | 397 | 12.5 x 20 | 0.041 | 1990 | 12.5 x 35 | 0.036 | 2600 | 12.5 x 40 | 0.032 | 2860 |
| | | | | | | | | 16 x 25 | 0.038 | 2430 |
| | | | | | | | | 18 x 20 | 0.045 | 2270 |
| 470 | 477 | 12.5 x 25 | 0.031 | 2460 | 12.5 x 40 | 0.032 | 2860 | 16 x 31.5 | 0.032 | 2640 |
| | | | | | 16 x 25 | 0.038 | 2430 | | | |
| | | | | | 18 x 20 | 0.045 | 2270 | 18 x 25 | 0.036 | 2500 |
| 560 | 567 | 12.5 x 30 | 0.028 | 2760 | 16 x 31.5 | 0.032 | 2640 | 16 x 35.5 | 0.029 | 2860 |
| | | 16 x 20 | 0.032 | 2380 | | | | 18 x 31.5 | 0.030 | 2860 |
| 680 | 687 | 12.5 x 35 | 0.024 | 3040 | 16 x 35.5 | 0.029 | 2860 | 16 x 40 | 0.027 | 3510 |
| | | | | | 18 x 25 | 0.036 | 2500 | 18 x 35.5 | 0.027 | 3510 |
| 820 | 827 | 16 x 25 | 0.025 | 2890 | 16 x 40 | 0.027 | 3510 | 18 x 40 | 0.026 | 3860 |
| | | | | | 18 x 31.5 | 0.030 | 2860 | | | |
| 1000 | 108 | | | | 18 x 35.5 | 0.027 | 3510 | | | |
| 1200 | 128 | | | | 18 x 40 | 0.026 | 3860 | | | |

Maximum Allowable Ripple Current (mArms) at 105°C 100kHz

Case Size Φ D x L (mm)

Maximum Impedance (Ω) at 20°C 100kHz

Specifications are subject to change without notice. Should a safety or technical concern arise regarding the product, please be sure to contact our sales offices or agents immediately.

+105°C, High Ripple Current (高紋波), Longer Life Assurance (較長壽命), Low Impedance (低阻抗品)

FEATURES

- Load life 105°C and low ESR.
- Excellent ripple current capability.
- Used in communication equipments, switching power supply, industrial measuring instruments, etc.



SPECIFICATIONS

| Item | Performance Characteristics |
|---------------------------------|--|
| Operating Temperature Range | -40 to +105°C |
| Rated Working Voltage Range | 6.3 to 100V |
| Nominal Capacitance Range | 15 to 4700µF |
| Capacitance Tolerance | ±20% at 120Hz, +20°C |
| Leakage Current | I ≤ 0.01CV or 3 (µA) whichever is greater measured after 2 minutes application of rated working voltage at +20°C |
| tan δ (120Hz, +20°C) | Working Voltage (V) |
| | tan δ (max.) |
| Low Temperature Characteristics | Impedance ratio max. at 120Hz |
| | Working Voltage (V) |
| | Z-25°C / Z+20°C |
| High Temperature Loading | Test time |
| | Test temperature |
| Shelf Life | At +105°C no voltage applied after 1,000 hours and then being stabilized at +20°C the capacitors shall meet the following limits |
| | Leakage current |
| Industrial Standard | JIS C - 5101-4 (IEC 60384-4) |

CASE SIZE TABLE



| φD | 6.3 | 8 (L < 20) | 8 (L ≥ 20) | 10 | 12.5 |
|----|-----|--------------|------------|--------------|------|
| F | 2.5 | 3.5 | 3.5 | 5.0 | 5.0 |
| φd | 0.5 | 0.5 | 0.6 | 0.6 | 0.6 |
| α | | (L < 20) 1.5 | | (L ≥ 20) 2.0 | |
| β | | (D < 20) 0.5 | | (D ≥ 20) 1.0 | |

PART NUMBER SYSTEM (EXAMPLE : 35V 2200µF)



STANDARD RATINGS

| Voltage (Code) | | 6.3V (0J) | | | 10V (1A) | | | 16V (1C) | | |
|----------------|------|-----------|-----------|----------------|-----------|-----------|----------------|-----------|-----------|----------------|
| Cap. (µF) | Code | Case Size | Impedance | Ripple Current | Case Size | Impedance | Ripple Current | Case Size | Impedance | Ripple Current |
| 100 | 107 | | | | | | | 6.3 x 11 | 0.286 | 298 |
| 120 | 127 | | | | | | | 6.3 x 11 | 0.286 | 298 |
| 150 | 157 | | | | 6.3 x 11 | 0.286 | 298 | 6.3 x 11 | 0.286 | 298 |
| | | | | | | | | 8 x 12 | 0.169 | 561 |
| 180 | 187 | | | | 6.3 x 11 | 0.286 | 298 | 6.3 x 11 | 0.286 | 298 |
| | | | | | | | | 8 x 12 | 0.169 | 561 |
| 220 | 227 | 6.3 x 11 | 0.286 | 298 | 6.3 x 11 | 0.286 | 298 | 6.3 x 11 | 0.286 | 298 |
| | | | | | | | | 8 x 12 | 0.169 | 561 |
| 270 | 227 | 6.3 x 11 | 0.286 | 298 | 6.3 x 11 | 0.286 | 298 | 8 x 12 | 0.169 | 561 |
| | | | | | 8 x 12 | 0.169 | 561 | | | |
| 330 | 337 | 6.3 x 11 | 0.286 | 298 | 6.3 x 11 | 0.286 | 298 | 8 x 12 | 0.169 | 561 |
| | | 8 x 12 | 0.169 | 561 | 8 x 12 | 0.169 | 561 | | | |
| 390 | 397 | 8 x 12 | 0.169 | 561 | 8 x 12 | 0.169 | 561 | 8 x 12 | 0.169 | 561 |
| 470 | 477 | 8 x 12 | 0.169 | 561 | 8 x 12 | 0.169 | 561 | 8 x 12 | 0.169 | 561 |
| | | | | | | | | 10 x 12.5 | 0.104 | 759 |
| 560 | 567 | 8 x 12 | 0.169 | 561 | 8 x 12 | 0.169 | 561 | 10 x 12.5 | 0.104 | 759 |
| 680 | 687 | 8 x 12 | 0.169 | 561 | 8 x 12 | 0.169 | 561 | 8 x 16 | 0.113 | 737 |
| | | | | | | | | 10 x 12.5 | 0.104 | 759 |
| 820 | 827 | 8 x 12 | 0.169 | 561 | 10 x 12.5 | 0.104 | 759 | 10 x 16 | 0.078 | 1061 |
| | | 10 x 12.5 | 0.104 | 759 | | | | | | |
| 1000 | 108 | 8 x 12 | 0.169 | 561 | 8 x 16 | 0.113 | 737 | 10 x 16 | 0.078 | 1061 |
| | | 10 x 12.5 | 0.104 | 759 | 10 x 16 | 0.078 | 1061 | | | |
| 1200 | 128 | 8 x 16 | 0.113 | 737 | 10 x 20 | 0.060 | 1228 | 10 x 20 | 0.060 | 1228 |
| | | 10 x 12.5 | 0.104 | 759 | | | | | | |
| 1500 | 158 | 8 x 20 | 0.090 | 921 | 10 x 20 | 0.060 | 1228 | 10 x 20 | 0.060 | 1228 |
| | | 10 x 16 | 0.078 | 1061 | | | | | | |
| 1800 | 188 | 10 x 20 | 0.060 | 1228 | 10 x 20 | 0.060 | 1228 | 10 x 25 | 0.055 | 1447 |
| | | | | | | | | 12.5 x 20 | 0.046 | 1666 |
| 2200 | 228 | 10 x 20 | 0.060 | 1228 | 10 x 20 | 0.060 | 1228 | 12.5 x 20 | 0.046 | 1666 |
| 2700 | 278 | 10 x 25 | 0.055 | 1447 | 10 x 25 | 0.055 | 1447 | 12.5 x 25 | 0.039 | 1863 |
| | | 12.5 x 20 | 0.046 | 1666 | 12.5 x 20 | 0.046 | 1666 | | | |
| 3300 | 338 | 10 x 25 | 0.055 | 1447 | 12.5 x 25 | 0.039 | 1863 | | | |
| | | 12.5 x 20 | 0.046 | 1666 | | | | | | |
| 3900 | 398 | 12.5 x 20 | 0.046 | 1666 | | | | | | |
| 4700 | 478 | 12.5 x 25 | 0.039 | 1863 | | | | | | |

Maximum Allowable Ripple Current (mArms) at 105°C 100kHz

Case Size Φ D x L (mm)

Maximum Impedance (Ω) at 20°C 100kHz



STANDARD RATINGS

| Voltage (Code) | | 25V (1E) | | | 35V (1V) | | | 50V (1H) | | |
|----------------|------|-----------|-----------|----------------|-----------|-----------|----------------|-----------|-----------|----------------|
| Cap. (μF) | Code | Case Size | Impedance | Ripple Current | Case Size | Impedance | Ripple Current | Case Size | Impedance | Ripple Current |
| 33 | 336 | | | | | | | 6.3 x 11 | 0.390 | 259 |
| 39 | 396 | | | | | | | 6.3 x 11 | 0.390 | 259 |
| 47 | 476 | | | | 6.3 x 11 | 0.286 | 298 | 6.3 x 11 | 0.390 | 259 |
| 56 | 566 | | | | 6.3 x 11 | 0.286 | 298 | 8 x 12 | 0.221 | 487 |
| 68 | 686 | | | | 6.3 x 11 | 0.286 | 298 | 8 x 12 | 0.221 | 487 |
| 82 | 826 | 6.3 x 11 | 0.286 | 298 | 8 x 12 | 0.169 | 561 | 8 x 12 | 0.221 | 487 |
| 100 | 107 | 6.3 x 11 | 0.286 | 298 | 8 x 12 | 0.169 | 561 | 10 x 12.5 | 0.156 | 667 |
| 120 | 127 | 8 x 12 | 0.169 | 561 | 8 x 12 | 0.169 | 561 | 8 x 16 | 0.156 | 640 |
| 150 | 157 | 8 x 12 | 0.169 | 561 | 8 x 12 | 0.169 | 561 | 10 x 12.5 | 0.156 | 667 |
| 180 | 187 | 8 x 12 | 0.169 | 561 | 8 x 12 | 0.169 | 561 | 10 x 16 | 0.109 | 921 |
| 220 | 227 | 8 x 12 | 0.169 | 561 | 10 x 12.5 | 0.104 | 759 | 8 x 20 | 0.118 | 798 |
| 270 | 277 | 8 x 12 | 0.169 | 561 | 10 x 12.5 | 0.104 | 759 | 10 x 16 | 0.109 | 921 |
| 330 | 337 | 8 x 12 | 0.169 | 561 | 8 x 16 | 0.113 | 737 | 10 x 16 | 0.109 | 921 |
| 390 | 397 | 10 x 12.5 | 0.104 | 759 | 10 x 12.5 | 0.104 | 759 | 10 x 16 | 0.104 | 759 |
| 470 | 477 | 10 x 12.5 | 0.104 | 759 | 10 x 16 | 0.078 | 1061 | 10 x 16 | 0.078 | 1061 |
| 560 | 567 | 8 x 12 | 0.169 | 561 | 8 x 20 | 0.090 | 921 | 12.5 x 20 | 0.059 | 1456 |
| 680 | 687 | 10 x 12.5 | 0.104 | 759 | 10 x 16 | 0.078 | 1061 | 10 x 16 | 0.078 | 1061 |
| 820 | 827 | 10 x 12.5 | 0.104 | 759 | 10 x 16 | 0.078 | 1061 | 12.5 x 20 | 0.059 | 1456 |
| 1000 | 108 | 8 x 16 | 0.113 | 737 | 10 x 16 | 0.078 | 1061 | 12.5 x 25 | 0.050 | 1620 |
| 1200 | 128 | 10 x 12.5 | 0.104 | 759 | 10 x 16 | 0.078 | 1061 | 10 x 16 | 0.078 | 1061 |
| 1500 | 158 | 10 x 16 | 0.078 | 1061 | 10 x 20 | 0.060 | 1228 | 12.5 x 25 | 0.050 | 1620 |
| 1800 | 188 | 10 x 16 | 0.078 | 1061 | 10 x 20 | 0.060 | 1228 | 10 x 20 | 0.060 | 1228 |
| 2200 | 228 | 10 x 20 | 0.060 | 1228 | 10 x 20 | 0.060 | 1228 | 10 x 25 | 0.055 | 1447 |
| | | 10 x 20 | 0.060 | 1228 | 12.5 x 20 | 0.046 | 1666 | 12.5 x 20 | 0.046 | 1666 |
| | | 10 x 25 | 0.055 | 1447 | 12.5 x 25 | 0.039 | 1863 | 12.5 x 25 | 0.039 | 1863 |
| | | 12.5 x 20 | 0.046 | 1666 | | | | | | |
| | | 12.5 x 25 | 0.039 | 1863 | | | | | | |
| | | 12.5 x 25 | 0.039 | 1863 | | | | | | |

Maximum Allowable Ripple Current (mArms) at 105°C 100kHz
Maximum Impedance (Ω) at 20°C 100kHz

Case Size ΦD x L (mm)

RS
Miniature Aluminum Electrolytic Capacitors

Specifications are subject to change without notice. Should a safety or technical concern arise regarding the product, please be sure to contact our sales offices or agents immediately.

STANDARD RATINGS

| Voltage (Code) | | 63V (1J) | | | 100V (2A) | | |
|----------------|------|-----------|-----------|----------------|-----------|-----------|----------------|
| Cap. (µF) | Code | Case Size | Impedance | Ripple Current | Case Size | Impedance | Ripple Current |
| 15 | 156 | | | | 6.3 x 11 | 1.560 | 101 |
| 22 | 226 | 6.3 x 11 | 1.560 | 101 | | | |
| 27 | 276 | 6.3 x 11 | 1.560 | 101 | 8 x 12 | 0.819 | 203 |
| 33 | 336 | 6.3 x 11 | 1.560 | 101 | | | |
| 39 | 396 | 8 x 12 | 0.819 | 203 | 8 x 16 | 0.585 | 263 |
| 47 | 476 | 8 x 12 | 0.819 | 203 | 10 x 12.5 | 0.559 | 253 |
| 56 | 566 | 8 x 12 | 0.819 | 203 | 8 x 20 | 0.429 | 317 |
| 68 | 686 | 8 x 12 | 0.819 | 203 | 10 x 16 | 0.403 | 313 |
| 82 | 826 | 10 x 12.5 | 0.559 | 253 | 10 x 20 | 0.273 | 409 |
| 100 | 107 | 8 x 16 | 0.585 | 263 | 10 x 20 | 0.273 | 409 |
| | | 10 x 12.5 | 0.559 | 253 | | | |
| 120 | 127 | 10 x 16 | 0.403 | 313 | 12.5 x 20 | 0.208 | 605 |
| 150 | 157 | 8 x 20 | 0.429 | 317 | | | |
| 180 | 187 | 10 x 20 | 0.273 | 409 | 12.5 x 25 | 0.156 | 688 |
| 220 | 227 | 10 x 20 | 0.273 | 409 | 12.5 x 25 | 0.156 | 688 |
| 270 | 277 | 12.5 x 20 | 0.208 | 605 | | | |
| 330 | 337 | 12.5 x 20 | 0.208 | 605 | | | |
| 390 | 397 | 12.5 x 25 | 0.156 | 688 | | | |

Maximum Allowable Ripple Current (mArms) at 105°C 100kHz

Case Size Φ D x L (mm)

Maximum Impedance (Ω) at 20°C 100kHz

RIPPLE CURRENT MULTIPLIER

Frequency Coefficient

| Coefficient \ Freq. (Hz) | 120 | 1k | 10k | 100k |
|--------------------------|------|------|------|------|
| Cap (µF) ≤180 | 0.40 | 0.75 | 0.90 | 1.00 |
| 220~560 | 0.50 | 0.85 | 0.94 | 1.00 |
| 680~1800 | 0.60 | 0.87 | 0.95 | 1.00 |
| 2200~3900 | 0.75 | 0.90 | 0.95 | 1.00 |
| 4700 | 0.85 | 0.95 | 0.98 | 1.00 |

Specifications are subject to change without notice. Should a safety or technical concern arise regarding the product, please be sure to contact our sales offices or agents immediately.

FEATURES

- Low impedance for high frequency.
- Load life of 4,000~10,000 hours at 105°C.



SPECIFICATIONS

| Item | Performance Characteristics |
|---------------------------------|--|
| Operating Temperature Range | -40 to +105°C |
| Rated Working Voltage Range | 6.3 to 100V |
| Nominal Capacitance Range | 3.3 to 15000µF |
| Capacitance Tolerance | ±20% at 120Hz, +20°C |
| Leakage Current | I ≤ 0.01CV or 3 (µA) whichever is greater measured after 2 minutes application of rated working voltage at +20°C |
| tan δ (120Hz, +20°C) | Working Voltage (V) |
| | tan δ (max.) |
| Low Temperature Characteristics | Impedance ratio max. at 120Hz |
| | Rated Voltage (V) |
| | Z-25°C / Z+20°C |
| High Temperature Loading | Test time |
| | Test temperature |
| | Test conditions |
| | Post test requirements at +20°C |
| Shelf Life | At +105°C no voltage applied after 1,000 hours and then being stabilized at +20°C the capacitors shall meet the following limits |
| | Leakage current |
| | Cap. change |
| Industrial Standard | JIS C - 5101-4 (IEC 60384-4) |

CASE SIZE TABLE



| φD | 6.3 | 8 (L < 20) | 8 (L ≥ 20) | 10 | 12.5 | 16 | 18 |
|----|-----|--------------|------------|-----|--------------|-----|-----|
| F | 2.5 | 3.5 | 3.5 | 5.0 | 5.0 | 7.5 | 7.5 |
| φd | 0.5 | 0.5 | 0.6 | 0.6 | 0.6 | 0.8 | 0.8 |
| α | | (L < 20) 1.5 | | | (L ≥ 20) 2.0 | | |
| β | | (D < 20) 0.5 | | | (D ≥ 20) 1.0 | | |

RIPPLE CURRENT MULTIPLIER

Frequency Coefficient

| Coefficient | 120 | 1k | 10k | 100k |
|-------------|------|------|------|------|
| 3.3~10 | 0.42 | 0.60 | 0.80 | 1.00 |
| 22~33 | 0.55 | 0.75 | 0.90 | 1.00 |
| 47~330 | 0.70 | 0.85 | 0.95 | 1.00 |
| 470~1000 | 0.75 | 0.90 | 0.98 | 1.00 |
| 2200~15000 | 0.80 | 0.95 | 1.00 | 1.00 |

PART NUMBER SYSTEM (EXAMPLE : 10V 1000µF)

| | | | | | | | |
|---|----|-----|---|----|----|-------|-------|
| 1 | 23 | 456 | 7 | 89 | 10 | 11 12 | 13 14 |
| E | GY | 108 | M | 1A | G | 16 | RR |



STANDARD RATINGS

| Voltage (Code) | | 6.3V (0J) | | | 10V (1A) | | | 16V (1C) | | |
|----------------|------|-----------|-----------|----------------|-----------|-----------|----------------|-----------|-----------|----------------|
| Cap. (µF) | Code | Case Size | Impedance | Ripple Current | Case Size | Impedance | Ripple Current | Case Size | Impedance | Ripple Current |
| 47 | 476 | | | | | | | 5 x 11 | 0.900 | 150 |
| 100 | 107 | 5 x 11 | 0.900 | 150 | 5 x 11 | 0.900 | 150 | 6.3 x 11 | 0.400 | 250 |
| 220 | 227 | 6.3 x 11 | 0.400 | 250 | 6.3 x 11 | 0.400 | 250 | 8 x 12 | 0.250 | 400 |
| 330 | 337 | 6.3 x 11 | 0.400 | 250 | 8 x 12 | 0.250 | 400 | 8 x 12 | 0.250 | 400 |
| 470 | 477 | 8 x 12 | 0.250 | 400 | 8 x 12 | 0.250 | 400 | 10 x 12.5 | 0.160 | 580 |
| 1000 | 108 | 10 x 12.5 | 0.160 | 580 | 10 x 16 | 0.120 | 770 | 10 x 20 | 0.078 | 1050 |
| 2200 | 228 | 12.5 x 20 | 0.062 | 1300 | 12.5 x 20 | 0.062 | 1300 | 12.5 x 25 | 0.048 | 1650 |
| 3300 | 338 | 12.5 x 20 | 0.062 | 1300 | 12.5 x 25 | 0.048 | 1650 | 16 x 25 | 0.034 | 1850 |
| 4700 | 478 | 16 x 25 | 0.034 | 1850 | 16 x 25 | 0.034 | 1850 | 16 x 30 | 0.029 | 2000 |
| 6800 | 688 | 16 x 25 | 0.034 | 1850 | 16 x 30 | 0.029 | 2000 | 18 x 35 | 0.025 | 2200 |
| 10000 | 109 | 16 x 30 | 0.029 | 2000 | 18 x 35 | 0.025 | 2200 | | | |
| 15000 | 159 | 18 x 35 | 0.025 | 2200 | | | | | | |

Maximum Allowable Ripple Current (mArms) at 105°C 100kHz

Case Size Φ D x L (mm)

Maximum Impedance (Ω) at 20°C 100kHz

| Voltage (Code) | | 25V (1E) | | | 35V (1V) | | | 50V (1H) | | |
|----------------|------|-----------|-----------|----------------|-----------|-----------|----------------|-----------|-----------|----------------|
| Cap. (µF) | Code | Case Size | Impedance | Ripple Current | Case Size | Impedance | Ripple Current | Case Size | Impedance | Ripple Current |
| 3.3 | 335 | | | | | | | 5 x 11 | 2.200 | 53 |
| 4.7 | 475 | | | | | | | 5 x 11 | 1.900 | 88 |
| 10 | 106 | | | | | | | 5 x 11 | 1.500 | 100 |
| 22 | 226 | | | | | | | 5 x 11 | 0.900 | 150 |
| 33 | 336 | 5 x 11 | 0.900 | 150 | 5 x 11 | 0.900 | 150 | 6.3 x 11 | 0.400 | 250 |
| 47 | 476 | 5 x 11 | 0.900 | 150 | 6.3 x 11 | 0.400 | 250 | 6.3 x 11 | 0.400 | 250 |
| 100 | 107 | 6.3 x 11 | 0.400 | 250 | 8 x 12 | 0.250 | 400 | 8 x 12 | 0.250 | 400 |
| 220 | 227 | 8 x 12 | 0.250 | 400 | 10 x 12.5 | 0.160 | 580 | 10 x 16 | 0.120 | 770 |
| 330 | 337 | 8 x 12 | 0.250 | 400 | 10 x 16 | 0.120 | 770 | 10 x 20 | 0.078 | 1050 |
| | | 10 x 12.5 | 0.160 | 580 | | | | | | |
| | | 10 x 12.5 | 0.160 | 580 | | | | | | |
| 470 | 477 | 10 x 16 | 0.120 | 770 | 10 x 20 | 0.078 | 1050 | 12.5 x 20 | 0.062 | 1300 |
| | | 10 x 20 | 0.078 | 1050 | | | | | | |
| | | 12.5 x 20 | 0.062 | 1300 | | | | | | |
| 1000 | 108 | 12.5 x 20 | 0.062 | 1300 | 12.5 x 25 | 0.048 | 1650 | 16 x 25 | 0.034 | 1850 |
| | | 12.5 x 25 | 0.048 | 1650 | | | | | | |
| | | 16 x 25 | 0.034 | 1850 | | | | | | |
| 2200 | 228 | 16 x 25 | 0.034 | 1850 | 16 x 30 | 0.029 | 2000 | 18 x 35 | 0.025 | 2200 |
| 3300 | 338 | 16 x 30 | 0.029 | 2000 | 18 x 35 | 0.025 | 2200 | | | |
| 4700 | 478 | 18 x 35 | 0.025 | 2200 | | | | | | |

Maximum Allowable Ripple Current (mArms) at 105°C 100kHz

Case Size Φ D x L (mm)

Maximum Impedance (Ω) at 20°C 100kHz

| Voltage (Code) | | 63V (1J) | | | 100V (2A) | | |
|----------------|------|-----------|-----------|----------------|-----------|-----------|----------------|
| Cap. (µF) | Code | Case Size | Impedance | Ripple Current | Case Size | Impedance | Ripple Current |
| 22 | 226 | 6.3 x 11 | 1.300 | 140 | 8 x 12 | 0.630 | 160 |
| 33 | 336 | 6.3 x 11 | 1.200 | 140 | 10 x 12.5 | 0.430 | 230 |
| 47 | 476 | 8 x 12 | 0.630 | 210 | 10 x 16 | 0.310 | 290 |
| 100 | 107 | 10 x 12.5 | 0.430 | 300 | 10 x 16 | 0.310 | 290 |
| | | | | | 12.5 x 20 | 0.160 | 430 |
| 220 | 227 | 10 x 20 | 0.210 | 520 | 16 x 25 | 0.073 | 900 |
| 330 | 337 | 12.5 x 20 | 0.160 | 660 | 16 x 25 | 0.073 | 900 |
| 470 | 477 | 12.5 x 25 | 0.120 | 750 | | | |
| 1000 | 108 | 16 x 30 | 0.054 | 1390 | | | |

Maximum Allowable Ripple Current (mArms) at 105°C 100kHz

Case Size Φ D x L (mm)

Maximum Impedance (Ω) at 20°C 100kHz

Specifications are subject to change without notice. Should a safety or technical concern arise regarding the product, please be sure to contact our sales offices or agents immediately.

-55°C~+105°C, Wide Temperature (寬溫度), High Ripple Current (高紋波), Low Impedance (低阻抗品)

FEATURES

- Load life of 1,000~4,000 hours at 105°C
- Enabled high ripple current by a reduction of impedance at high frequency range.



SPECIFICATIONS

| Item | Performance Characteristics |
|---------------------------------|--|
| Operating Temperature Range | -55 to +105°C |
| Rated Working Voltage Range | 6.3 to 100V |
| Nominal Capacitance Range | 22 to 4700µF |
| Capacitance Tolerance | ±20% at 120Hz, +20°C |
| Leakage Current | I ≤ 0.01CV or 3 (µA) whichever is greater measured after 2 minutes application of rated working voltage at +20°C |
| tan δ (120Hz, +20°C) | Working Voltage (V) |
| | tan δ (max.) |
| Low Temperature Characteristics | Impedance ratio max. at 120 Hz |
| | Working Voltage (V) |
| | Z-25°C / Z+20°C |
| | Z-40°C / Z+20°C |
| High Temperature Loading | Test time |
| | Test temperature |
| | Test conditions |
| Shelf Life | At +105°C no voltage applied after 1,000 hours and then being stabilized at +20°C the capacitors shall meet the following limits |
| | Leakage current |
| | Cap. change |
| Industrial Standard | JIS C - 5101-4 (IEC 60384-4) EIAJ RC - 2372 |

CASE SIZE TABLE



| φD | 6.3 | 8(L <20) | 8(L <20) | 10 | 12.5 |
|----|-------------|----------|----------|-------------|------|
| F | 2.5 | 3.5 | 3.5 | 5.0 | 5.0 |
| φd | 0.5 | 0.5 | 0.6 | 0.6 | 0.6 |
| α | (L <20) 1.5 | | | (L ≥20) 2.0 | |
| β | (D <20) 0.5 | | | (D ≥20) 1.0 | |

RIPPLE CURRENT MULTIPLIER

Frequency Coefficient

| Coefficient | 60 | 120 | 1k | 10k | 100k |
|-------------|------|------|------|------|------|
| 22~330 | 0.55 | 0.75 | 0.85 | 0.90 | 1.00 |
| 390~1000 | 0.70 | 0.75 | 0.90 | 0.95 | 1.00 |
| 1200~2200 | 0.75 | 0.80 | 0.90 | 0.95 | 1.00 |
| 2700~4700 | 0.80 | 0.85 | 0.95 | 1.00 | 1.00 |

PART NUMBER SYSTEM (EXAMPLE : 16V 330µF)



STANDARD RATINGS

| Voltage (Code) | | 6.3V (0J) | | | 10V (1A) | | | 16V (1C) | | |
|----------------|------|-----------|-----------|----------------|-----------|-----------|----------------|-----------|-----------|----------------|
| Cap. (μF) | Code | Case Size | Impedance | Ripple Current | Case Size | Impedance | Ripple Current | Case Size | Impedance | Ripple Current |
| 100 | 107 | | | | | | | 6.3 x 11 | 0.220 | 340 |
| 120 | 127 | | | | | | | 6.3 x 11 | 0.220 | 340 |
| 150 | 157 | | | | 6.3 x 11 | 0.220 | 340 | 6.3 x 11 | 0.220 | 340 |
| 180 | 187 | 6.3 x 11 | 0.220 | 340 | 6.3 x 11 | 0.220 | 340 | 6.3 x 11 | 0.220 | 340 |
| 220 | 227 | 6.3 x 11 | 0.220 | 340 | 6.3 x 11 | 0.220 | 340 | 8 x 12 | 0.130 | 640 |
| 270 | 277 | 6.3 x 11 | 0.220 | 340 | 6.3 x 11 | 0.220 | 340 | 8 x 12 | 0.130 | 640 |
| 330 | 337 | 6.3 x 11 | 0.220 | 340 | 8 x 12 | 0.130 | 640 | 8 x 12 | 0.130 | 640 |
| 390 | 397 | 8 x 12 | 0.130 | 640 | 8 x 12 | 0.130 | 640 | 8 x 12 | 0.130 | 640 |
| 470 | 477 | 8 x 12 | 0.130 | 640 | 8 x 12 | 0.130 | 640 | 8 x 12 | 0.130 | 640 |
| | | | | | | | | 10 x 12.5 | 0.080 | 865 |
| 560 | 567 | 8 x 12 | 0.130 | 640 | 8 x 12 | 0.130 | 640 | 10 x 12.5 | 0.080 | 865 |
| 680 | 687 | 8 x 12 | 0.130 | 640 | 8 x 12 | 0.130 | 640 | 8 x 16 | 0.087 | 840 |
| | | | | | | | | 10 x 12.5 | 0.080 | 865 |
| 820 | 827 | 8 x 12 | 0.130 | 640 | 10 x 12.5 | 0.080 | 865 | 10 x 16 | 0.060 | 1210 |
| | | 10 x 12.5 | 0.080 | 865 | | | | | | |
| 1000 | 108 | 8 x 12 | 0.130 | 640 | 8 x 16 | 0.087 | 840 | 10 x 16 | 0.060 | 1210 |
| | | 10 x 12.5 | 0.080 | 865 | | | | | | |
| 1200 | 128 | 8 x 16 | 0.087 | 840 | 10 x 20 | 0.046 | 1400 | 10 x 20 | 0.046 | 1400 |
| | | 10 x 12.5 | 0.080 | 865 | | | | | | |
| 1500 | 158 | 10 x 16 | 0.060 | 1210 | 10 x 20 | 0.046 | 1400 | 10 x 20 | 0.046 | 1400 |
| 1800 | 188 | 10 x 20 | 0.046 | 1400 | 10 x 20 | 0.046 | 1400 | 12.5 x 20 | 0.035 | 1900 |
| 2200 | 228 | 10 x 20 | 0.046 | 1400 | 10 x 20 | 0.046 | 1400 | 12.5 x 20 | 0.035 | 1900 |
| | | 10 x 25 | 0.042 | 1650 | | | | | | |
| 2700 | 278 | 12.5 x 20 | 0.035 | 1900 | 12.5 x 20 | 0.035 | 1900 | 12.5 x 25 | 0.030 | 2124 |
| | | 10 x 25 | 0.042 | 1650 | | | | | | |
| 3300 | 338 | 12.5 x 20 | 0.035 | 1900 | 12.5 x 25 | 0.030 | 2124 | | | |
| | | 10 x 25 | 0.042 | 1650 | | | | | | |
| 3900 | 398 | 12.5 x 20 | 0.035 | 1900 | | | | | | |
| 4700 | 478 | 12.5 x 25 | 0.030 | 2124 | | | | | | |

Maximum Allowable Ripple Current (mArms) at 105°C 100kHz

Case Size ΦD x L (mm)

Maximum Impedance (Ω) at 20°C 100kHz



STANDARD RATINGS

| Voltage (Code) | | 25V (1E) | | | 35V (1V) | | | 50V (1H) | | |
|----------------|------|-----------|-----------|----------------|-----------|-----------|----------------|-----------|-----------|----------------|
| Cap. (μF) | Code | Case Size | Impedance | Ripple Current | Case Size | Impedance | Ripple Current | Case Size | Impedance | Ripple Current |
| 33 | 336 | | | | | | | 6.3 x 11 | 0.300 | 295 |
| 39 | 396 | | | | | | | 6.3 x 11 | 0.300 | 295 |
| 47 | 476 | | | | 6.3 x 11 | 0.220 | 340 | 6.3 x 11 | 0.300 | 295 |
| 56 | 566 | | | | 6.3 x 11 | 0.220 | 340 | 8 x 12 | 0.170 | 555 |
| 68 | 686 | | | | 6.3 x 11 | 0.220 | 340 | 8 x 12 | 0.170 | 555 |
| 82 | 826 | 6.3 x 11 | 0.220 | 340 | 8 x 12 | 0.130 | 640 | 8 x 12 | 0.170 | 555 |
| 100 | 107 | 6.3 x 11 | 0.220 | 340 | 8 x 12 | 0.130 | 640 | 10 x 12.5 | 0.120 | 760 |
| 120 | 127 | 8 x 12 | 0.130 | 640 | 8 x 12 | 0.130 | 640 | 8 x 16 | 0.120 | 730 |
| 150 | 157 | 8 x 12 | 0.130 | 640 | 8 x 12 | 0.130 | 640 | 10 x 12.5 | 0.120 | 760 |
| 180 | 187 | 8 x 12 | 0.130 | 640 | 8 x 12 | 0.130 | 640 | 10 x 16 | 0.084 | 1050 |
| 220 | 227 | 8 x 12 | 0.130 | 640 | 10 x 12.5 | 0.080 | 865 | 8 x 20 | 0.091 | 910 |
| 270 | 277 | 8 x 12 | 0.130 | 640 | 10 x 12.5 | 0.080 | 865 | 10 x 16 | 0.084 | 1050 |
| 330 | 337 | 10 x 12.5 | 0.080 | 865 | 8 x 16 | 0.087 | 840 | 10 x 16 | 0.084 | 1050 |
| 390 | 397 | 8 x 12 | 0.130 | 640 | 10 x 12.5 | 0.080 | 865 | 10 x 25 | 0.055 | 1440 |
| 470 | 477 | 10 x 12.5 | 0.080 | 865 | 8 x 20 | 0.069 | 1050 | 12.5 x 20 | 0.045 | 1660 |
| 560 | 567 | 10 x 12.5 | 0.080 | 865 | 10 x 16 | 0.060 | 1210 | 10 x 16 | 0.060 | 1210 |
| 680 | 687 | 8 x 16 | 0.087 | 840 | 10 x 16 | 0.060 | 1210 | 12.5 x 20 | 0.045 | 1660 |
| 820 | 827 | 10 x 12.5 | 0.080 | 865 | 10 x 16 | 0.060 | 1210 | 12.5 x 25 | 0.034 | 1950 |
| 1000 | 108 | 10 x 16 | 0.060 | 1210 | 10 x 20 | 0.046 | 1400 | 12.5 x 25 | 0.034 | 1950 |
| 1200 | 128 | 10 x 16 | 0.060 | 1210 | 10 x 20 | 0.046 | 1400 | | | |
| 1500 | 158 | 10 x 20 | 0.046 | 1400 | 10 x 20 | 0.046 | 1400 | | | |
| 1800 | 188 | 10 x 20 | 0.046 | 1400 | 12.5 x 20 | 0.035 | 1900 | | | |
| 2200 | 228 | 10 x 20 | 0.046 | 1400 | 12.5 x 25 | 0.030 | 2124 | | | |
| | | 10 x 25 | 0.042 | 1650 | | | | | | |
| | | 12.5 x 20 | 0.035 | 1900 | | | | | | |
| | | 12.5 x 25 | 0.030 | 2124 | | | | | | |
| | | 12.5 x 25 | 0.030 | 2124 | | | | | | |

Maximum Allowable Ripple Current (mArms) at 105°C 100kHz

Case Size ΦD x L (mm)

Maximum Impedance (Ω) at 20°C 100kHz

Specifications are subject to change without notice. Should a safety or technical concern arise regarding the product, please be sure to contact our sales offices or agents immediately.

RF

Miniature Aluminum Electrolytic Capacitors

STANDARD RATINGS

| Voltage (Code) | | 63V (1J) | | | 100V (2A) | | |
|----------------|------|-----------|-----------|----------------|-----------|-----------|----------------|
| Cap. (μF) | Code | Case Size | Impedance | Ripple Current | Case Size | Impedance | Ripple Current |
| 22 | 226 | 6.3 x 11 | 0.960 | 115 | | | |
| 33 | 336 | 6.3 x 11 | 0.960 | 115 | | | |
| 39 | 396 | 8 x 12 | 0.504 | 232 | 8 x 16 | 0.360 | 300 |
| 47 | 476 | 8 x 12 | 0.504 | 232 | 10 x 12.5 | 0.344 | 314 |
| 56 | 566 | 8 x 12 | 0.504 | 232 | 8 x 20 | 0.264 | 362 |
| 68 | 686 | 8 x 12 | 0.504 | 232 | 10 x 16 | 0.248 | 357 |
| 82 | 826 | 10 x 12.5 | 0.344 | 314 | 10 x 20 | 0.168 | 466 |
| 100 | 107 | 8 x 16 | 0.360 | 300 | 10 x 20 | 0.168 | 466 |
| | | 10 x 12.5 | 0.344 | 314 | | | |
| 120 | 127 | 10 x 16 | 0.248 | 357 | 12.5 x 20 | 0.128 | 690 |
| 150 | 157 | 8 x 20 | 0.264 | 362 | | | |
| 180 | 187 | 10 x 20 | 0.168 | 466 | 12.5 x 25 | 0.096 | 922 |
| 220 | 227 | 10 x 20 | 0.168 | 466 | 12.5 x 25 | 0.096 | 922 |
| 270 | 277 | 12.5 x 20 | 0.128 | 690 | | | |
| 330 | 337 | 12.5 x 20 | 0.128 | 690 | | | |
| 390 | 397 | 12.5 x 25 | 0.096 | 922 | | | |

Maximum Allowable Ripple Current (mArms) at 105°C 100kHz

Case Size ΦD x L (mm)

Maximum Impedance (Ω) at 20°C 100kHz

Specifications are subject to change without notice. Should a safety or technical concern arise regarding the product, please be sure to contact our sales offices or agents immediately.

FEATURES

- High ripple current.
- For electronic ballast, power supply.



SPECIFICATIONS

| Item | Performance Characteristics | | | | | | |
|---------------------------------|--|--|------|---------------|---|------|------|
| Operating Temperature Range | -40 to +105°C | | | -25 to +105°C | | | |
| Rated Working Voltage Range | 160 to 400V | | | 450V | | | |
| Nominal Capacitance Range | 1 to 220µF | | | | | | |
| Capacitance Tolerance | ±20% at 120Hz, +20°C | | | | | | |
| Leakage Current | I ≤ 0.02CV + 25 (µA) after 2 minutes application of rated working voltage at +20°C | | | | | | |
| tan δ (120Hz, +20°C) | Working Voltage (V) | 160 | 200 | 250 | 350 | 400 | 450 |
| | tan δ (max.) | 0.15 | 0.15 | 0.15 | 0.20 | 0.20 | 0.20 |
| Surge Voltage | Working Voltage (V) | 160 | 200 | 250 | 350 | 400 | 450 |
| | Surge Voltage (V) | 200 | 250 | 300 | 400 | 450 | 500 |
| Low Temperature Characteristics | Impedance ratio max. at 120Hz | | | | | | |
| | Working Voltage (V) | 160 | 200 | 250 | 350 | 400 | 450 |
| | Z-25°C / Z+20°C | 3 | 3 | 3 | 5 | 5 | 6 |
| High Temperature Loading | Test time | : 3,000 hours | | | Post test requirements at +20°C | | |
| | Test temperature | : +105°C | | | Leakage current : ≤ Initial specified value | | |
| | Test conditions | : Rated DC working voltage with rated ripple current | | | Cap. change : within ±20% of the initial measured value | | |
| | | | | | tan δ : ≤ 200% of the initial specified value | | |
| Shelf Life | At +105°C no voltage applied after 1,000 hours and then being stabilized at +20°C the capacitors shall meet the following limits | | | | | | |
| | Leakage current | : ≤ Initial specified value | | | | | |
| | Cap. change | : within ±20% of the initial measured value | | | | | |
| | tan δ | : ≤ 200% of the initial specified value | | | | | |
| Industrial Standard | JIS C - 5101-4 (IEC 60384-4) | | | | | | |

CASE SIZE TABLE



| | | | | | | |
|----|--------------|------------|-----|--------------|-----|-----|
| φD | 8 (L < 20) | 8 (L ≥ 20) | 10 | 12.5 | 16 | 18 |
| F | 3.5 | 3.5 | 5.0 | 5.0 | 7.5 | 7.5 |
| φd | 0.5 | 0.6 | 0.6 | 0.6 | 0.8 | 0.8 |
| α | (L < 20) 1.5 | | | (L ≥ 20) 2.0 | | |
| β | (D < 20) 0.5 | | | (D ≥ 20) 1.0 | | |

RIPPLE CURRENT MULTIPLIER

Frequency Coefficient

| Coefficient Cap (µF) | 120 | 1k | 10k | 100k |
|-------------------------|------|------|------|------|
| 1~5.6 | 0.20 | 0.40 | 0.80 | 1.00 |
| 6.8~180 | 0.40 | 0.75 | 0.90 | 1.00 |
| ≥ 220 | 0.50 | 0.85 | 0.94 | 1.00 |

PART NUMBER SYSTEM (EXAMPLE : 200V 220µF)

| | | | | | | | |
|---|----|-----|---|----|----|-------|-------|
| 1 | 23 | 456 | 7 | 89 | 10 | 11 12 | 13 14 |
| E | RR | 227 | M | 2D | L | 30 | RR |



STANDARD RATINGS

| Voltage (Code) | | 160V (2C) | | 200V (2D) | | 250V (2E) | | 350V (2V) | |
|----------------|------|----------------------|----------------|----------------------|----------------|----------------------|----------------|-----------|----------------|
| Cap. (µF) | Code | Case Size | Ripple Current | Case Size | Ripple Current | Case Size | Ripple Current | Case Size | Ripple Current |
| 4.7 | 475 | | | | | 8 x 12 | 160 | 10 x 12.5 | 150 |
| 5.6 | 565 | | | | | | | 10 x 12.5 | 180 |
| 6.8 | 685 | | | 8 x 12 | 204 | 8 x 12 10 x 12.5 | 215 250 | 10 x 16 | 280 |
| 10 | 106 | 10 x 16 | 320 | 10 x 16 | 320 | 10 x 16 | 320 | 10 x 20 | 350 |
| 22 | 226 | 10 x 20 | 500 | 10 x 16 10 x 20 | 453 500 | 10 x 16 10 x 20 | 453 500 | 12.5 x 20 | 650 |
| 33 | 336 | 10 x 20 | 650 | 10 x 16 10 x 20 | 589 650 | 10 x 16 12.5 x 20 | 640 800 | 16 x 20 | 900 |
| 47 | 476 | 10 x 20 | 750 | 12.5 x 20 | 980 | 12.5 x 20 | 980 | 16 x 20 | 1080 |
| 68 | 686 | 12.5 x 20 | 1180 | 12.5 x 25 16 x 20 | 1300 1300 | 16 x 20 | 1300 | 18 x 25 | 1470 |
| 82 | 826 | | | 16 x 20 | 1380 | 16 x 20 | 1380 | 18 x 25 | 1530 |
| 100 | 107 | 12.5 x 25 16 x 20 | 1420 1420 | 16 x 20 | 1420 | 16 x 25 | 1530 | | |
| 150 | 157 | 16 x 25 | 1890 | 16 x 25 | 1890 | 18 x 25 | 1940 | | |
| 220 | 227 | 18 x 25 | 2370 | 18 x 30 | 2648 | | | | |

Maximum Allowable Ripple Current (mArms) at 105°C 100kHz

Case Size Φ D x L (mm)

| Voltage (Code) | | 400V (2G) | | 450V (2W) | |
|----------------|------|-----------|----------------|-----------|----------------|
| Cap. (µF) | Code | Case Size | Ripple Current | Case Size | Ripple Current |
| 1 | 105 | 8 x 12 | 60 | | |
| 1.5 | 155 | 8 x 12 | 90 | | |
| | | 10 x 12.5 | 100 | | |
| 1.8 | 185 | 8 x 12 | 95 | | |
| | | 10 x 12.5 | 120 | | |
| 2.2 | 225 | 8 x 12 | 95 | 8 x 12 | 105 |
| | | 10 x 12.5 | 140 | | |
| 3.3 | 335 | 8 x 12 | 130 | | |
| | | 10 x 12.5 | 150 | | |
| 4.7 | 475 | 8 x 12 | 171 | 8 x 16 | 176 |
| | | 10 x 16 | 220 | 10 x 20 | 220 |
| 5.6 | 565 | 10 x 16 | 250 | 10 x 20 | 250 |
| | | | | 10 x 12.5 | 228 |
| 6.8 | 685 | 10 x 16 | 280 | 10 x 20 | 280 |
| | | | | 10 x 20 | 397 |
| 10 | 106 | 10 x 16 | 317 | 10 x 20 | 350 |
| | | 10 x 20 | 350 | 12.5 x 20 | 450 |
| 15 | 156 | 12.5 x 15 | 487 | 12.5 x 25 | 600 |
| | | 12.5 x 20 | 550 | | |
| 22 | 226 | 12.5 x 20 | 760 | 12.5 x 25 | 698 |
| | | | | 16 x 20 | 730 |
| 33 | 336 | 12.5 x 25 | 861 | 16 x 20 | 891 |
| | | 16 x 20 | 900 | 16 x 25 | 980 |
| 47 | 476 | 12.5 x 25 | 1027 | 16 x 25 | 1121 |
| | | 16 x 20 | 1073 | 18 x 20 | 1093 |
| 68 | 686 | 16 x 25 | 1180 | 18 x 25 | 1200 |
| | | 18 x 20 | 1180 | | |
| 68 | 686 | 16 x 25 | 1374 | | |
| | | 16 x 30 | 1488 | | |
| | | 18 x 25 | 1470 | | |

Maximum Allowable Ripple Current (mArms) at 105°C 100kHz

Case Size Φ D x L (mm)

Specifications are subject to change without notice. Should a safety or technical concern arise regarding the product, please be sure to contact our sales offices or agents immediately.

FEATURES

- High ripple current & load life 5,000 hours.
- For electronic ballast, power supply.

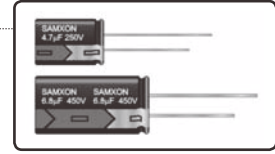

SPECIFICATIONS

| Item | Performance Characteristics | | | | | | |
|---------------------------------|--|--|------|---------------|---|------|------|
| Operating Temperature Range | -40 to +105°C | | | -25 to +105°C | | | |
| Rated Working Voltage Range | 160 to 400V | | | 450V | | | |
| Nominal Capacitance Range | 1 to 220µF | | | | | | |
| Capacitance Tolerance | ±20% at 120Hz, +20°C | | | | | | |
| Leakage Current | I ≤ 0.02CV + 25 (µA) after 2 minutes application of rated working voltage at +20°C | | | | | | |
| tan δ (120Hz, +20°C) | Working Voltage (V) | 160 | 200 | 250 | 350 | 400 | 450 |
| | tan δ (max.) | 0.15 | 0.15 | 0.15 | 0.20 | 0.20 | 0.20 |
| Low Temperature Characteristics | Impedance ratio max. at 120Hz | | | | | | |
| | Working Voltage (V) | 160 | 200 | 250 | 350 | 400 | 450 |
| | Z-25°C / Z+20°C | 3 | 3 | 3 | 5 | 5 | 6 |
| High Temperature Loading | Test time | 5,000 hours | | | Post test requirements at +20°C | | |
| | Test temperature | +105°C | | | Leakage current : ≤ Initial specified value | | |
| | Test conditions | Rated DC working voltage with rated ripple current | | | Cap. change : within ±20% of the initial measured value | | |
| | | | | | tan δ : ≤ 200% of the initial specified value | | |
| Shelf Life | At +105°C no voltage applied after 1,000 hours and then being stabilized at +20°C the capacitors shall meet the following limits | | | | | | |
| | Leakage current | : ≤ Initial specified value | | | | | |
| | Cap. change | : within ±20% of the initial measured value | | | | | |
| | tan δ | : ≤ 200% of the initial specified value | | | | | |
| Industrial Standard | JIS C - 5101-4 (IEC 60384-4) | | | | | | |

CASE SIZE TABLE

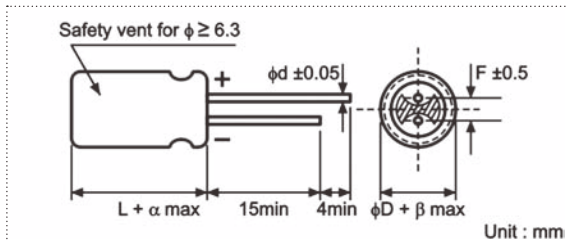

| | | | | | | |
|-----|--------------|------------|-----|--------------|-----|-----|
| Φ D | 8 (L < 20) | 8 (L ≥ 20) | 10 | 12.5 | 16 | 18 |
| F | 3.5 | 3.5 | 5.0 | 5.0 | 7.5 | 7.5 |
| Φ d | 0.5 | 0.6 | 0.6 | 0.6 | 0.8 | 0.8 |
| α | (L < 20) 1.5 | | | (L ≥ 20) 2.0 | | |
| β | (D < 20) 0.5 | | | (D ≥ 20) 1.0 | | |

RIPPLE CURRENT MULTIPLIER

Frequency Coefficient

| Coefficient | 120 | 1k | 10k | 100k |
|-------------|------|------|------|------|
| Cap (µF) | | | | |
| 1~5.6 | 0.20 | 0.40 | 0.80 | 1.00 |
| 6.8~180 | 0.40 | 0.75 | 0.90 | 1.00 |
| ≥ 220 | 0.50 | 0.85 | 0.94 | 1.00 |

PART NUMBER SYSTEM (EXAMPLE : 250V 22µF)

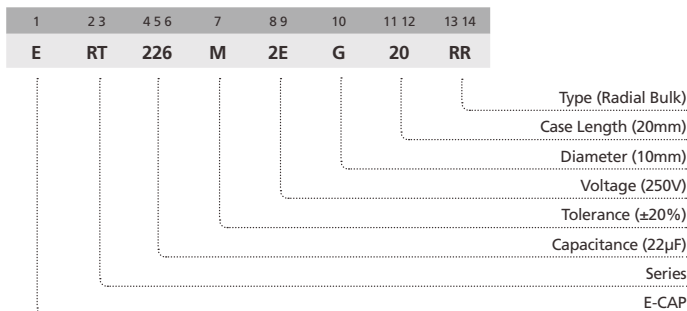

STANDARD RATINGS

| Voltage (Code) | | 160V (2C) | | 200V (2D) | | 250V (2E) | | 350V (2V) | |
|----------------|------|----------------------|----------------|----------------------|----------------|----------------------|----------------|-----------|----------------|
| Cap. (µF) | Code | Case Size | Ripple Current | Case Size | Ripple Current | Case Size | Ripple Current | Case Size | Ripple Current |
| 4.7 | 475 | | | | | 8 x 12 | 160 | 10 x 12.5 | 150 |
| 5.6 | 565 | | | | | | | 10 x 12.5 | 180 |
| 6.8 | 685 | | | 8 x 12 | 204 | 8 x 12 10 x 12.5 | 215 250 | 10 x 16 | 280 |
| 10 | 106 | 10 x 16 | 320 | 10 x 16 | 320 | 10 x 16 | 320 | 10 x 20 | 350 |
| 22 | 226 | 10 x 20 | 500 | 10 x 16 10 x 20 | 453 500 | 10 x 16 10 x 20 | 453 500 | 12.5 x 20 | 650 |
| 33 | 336 | 10 x 20 | 650 | 10 x 16 10 x 20 | 589 650 | 10 x 16 12.5 x 20 | 640 800 | 16 x 20 | 900 |
| 47 | 476 | 10 x 20 | 750 | 12.5 x 20 | 980 | 12.5 x 20 | 980 1200* | 16 x 20 | 1080 |
| 68 | 686 | 12.5 x 20 | 1180 | 12.5 x 25 16 x 20 | 1300 1300 | 16 x 20 | 1300 | 18 x 25 | 1470 |
| 82 | 826 | | | 16 x 20 | 1380 | 16 x 20 | 1380 | 18 x 25 | 1530 |
| 100 | 107 | 12.5 x 25 16 x 20 | 1420 1420 | 16 x 20 | 1420 | 16 x 25 | 1530 | | |
| 150 | 157 | 16 x 25 | 1890 | 16 x 25 | 1890 | 18 x 25 | 1940 | | |
| 220 | 227 | 18 x 25 | 2370 | 18 x 30 | 2648 | | | | |

Maximum Allowable Ripple Current (mArms) at 105°C 100kHz

Case Size ΦD x L (mm)

| Voltage (Code) | | 400V (2G) | | 450V (2W) | |
|----------------|------|--|------------------------------|-------------------------------|----------------------|
| Cap. (µF) | Code | Case Size | Ripple Current | Case Size | Ripple Current |
| 1 | 105 | 8 x 12 | 60 | | |
| 1.5 | 155 | 8 x 12 10 x 12.5 | 90 100 | | |
| 1.8 | 185 | 8 x 12 10 x 12.5 | 95 120 | | |
| 2.2 | 225 | 8 x 12 10 x 12.5 | 95 140 | 8 x 12 | 105 |
| 3.3 | 335 | 8 x 12 10 x 12.5 | 130 150 | | |
| 4.7 | 475 | 8 x 12 10 x 16 | 171 220 | 8 x 16 10 x 20 | 176 220 |
| 5.6 | 565 | 10 x 16 | 250 | 10 x 20 | 250 |
| 6.8 | 685 | 10 x 16 | 280 | 10 x 12.5 10 x 20 | 228 280 |
| 10 | 106 | 10 x 16 10 x 20 | 317 350 | 10 x 20 12.5 x 20 | 397 450 |
| 15 | 156 | 12.5 x 25 12.5 x 20 | 487 550 | 12.5 x 25 | 600 |
| 22 | 226 | 12.5 x 20 | 760 | 12.5 x 25 16 x 20 | 698 730 |
| 33 | 336 | 12.5 x 25 16 x 20 | 861 900 | 16 x 20 16 x 25 | 891 980 |
| 47 | 476 | 12.5 x 25 16 x 20 16 x 25 18 x 20 | 1027 1073 1180 1180 | 16 x 25 18 x 20 18 x 25 | 1121 1093 1200 |
| 68 | 686 | 16 x 25 16 x 30 18 x 25 | 1374 1488 1470 | | |
| 100 | 107 | | | 18 x 35 | 2088 |
| 120 | 127 | | | 18 x 40 | 2325 |

Maximum Allowable Ripple Current (mArms) at 105°C 100kHz

Case Size ΦD x L (mm)

* Special item with higher ripple current.

Specifications are subject to change without notice. Should a safety or technical concern arise regarding the product, please be sure to contact our sales offices or agents immediately.

TEMPERATURE CHARACTERISTICS

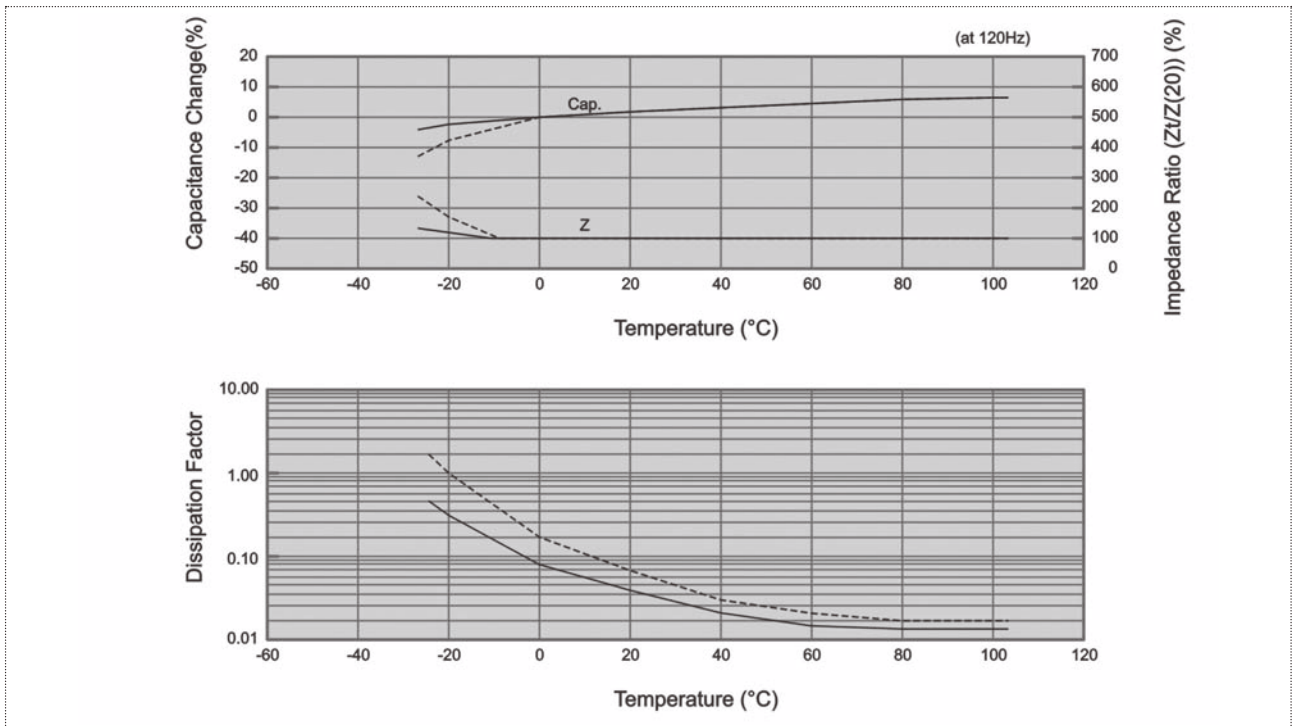

ENDURANCE

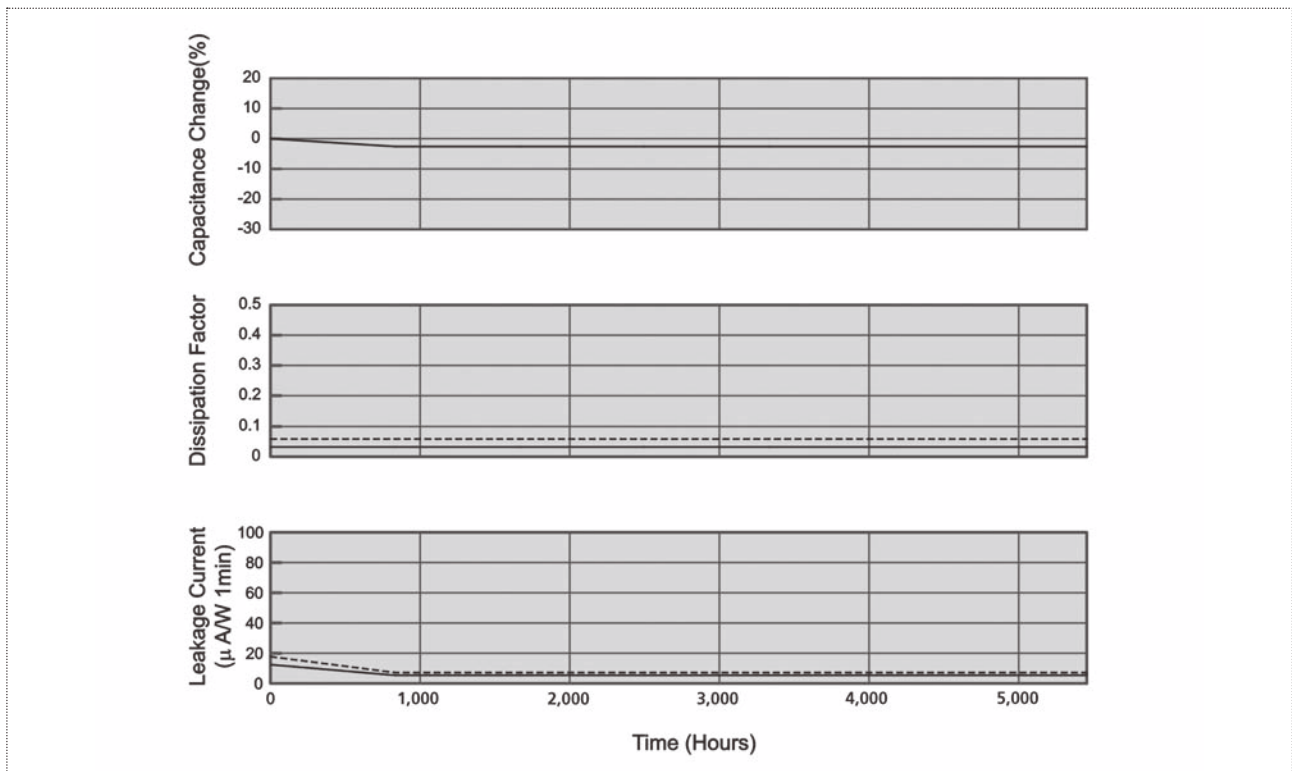

FEATURES

- Load life of 8,000~10,000 hours at 105°C.
- For electronic ballast.



SPECIFICATIONS

| Item | Performance Characteristics | | | | | | |
|---------------------------------|--|--|--------|---------|---|------|------|
| Operating Temperature Range | -25 to +105°C | | | | | | |
| Rated Working Voltage Range | 160 to 450V | | | | | | |
| Nominal Capacitance Range | 1 to 220µF | | | | | | |
| Capacitance Tolerance | ±20% at 120Hz, +20°C | | | | | | |
| Leakage Current | I ≤ 0.02CV + 25 (µA) after 2 minutes application of rated working voltage at +20°C | | | | | | |
| tan δ (120Hz, +20°C) | Working Voltage (V) | 160 | 200 | 250 | 350 | 400 | 450 |
| | tan δ (max.) | 0.15 | 0.15 | 0.15 | 0.20 | 0.20 | 0.20 |
| Low Temperature Characteristics | Impedance ratio max. at 120Hz | | | | | | |
| | Rated Voltage (V) | 160 | 200 | 250 | 350 | 400 | 450 |
| | Z-25°C / Z+20°C | 3 | 3 | 3 | 6 | 6 | 6 |
| High Temperature Loading | Test time | ΦD | 8~10 | 12.5~18 | Post test requirements at +20°C | | |
| | Load life | | 8,000h | 10,000h | Leakage current : ≤ Initial specified value | | |
| | Test temperature | +105°C | | | Cap. change : within ±20% of the initial measured value | | |
| Shelf Life | Test conditions | Rated DC working voltage with rated ripple current | | | tan δ : ≤ 200% of the initial specified value | | |
| | At +105°C no voltage applied after 1,000 hours and then being stabilized at +20°C the capacitors shall meet the following limits | | | | | | |
| | Leakage current | : ≤ Initial specified value | | | | | |
| Industrial Standard | Cap. change | : within ±20% of the initial measured value | | | | | |
| | tan δ | : ≤ 200% of the initial specified value | | | | | |
| Industrial Standard | JIS C - 5101-4 (IEC 60384-4) | | | | | | |

CASE SIZE TABLE

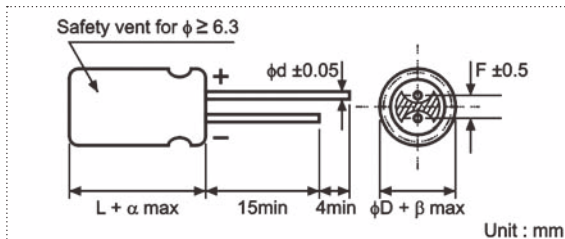

| | ΦD | 8 (L < 20) | 8 (L ≥ 20) | 10 | 12.5 | 16 | 18 |
|----|----|--------------|------------|--------------|------|-----|-----|
| F | | 3.5 | 3.5 | 5.0 | 5.0 | 7.5 | 7.5 |
| Φd | | 0.5 | 0.6 | 0.6 | 0.6 | 0.8 | 0.8 |
| α | | (L < 20) 1.5 | | (L ≥ 20) 2.0 | | | |
| β | | (D < 20) 0.5 | | (D ≥ 20) 1.0 | | | |

RIPPLE CURRENT MULTIPLIER

Frequency Coefficient

| Coefficient | Freq. (Hz) | 120 | 1k | 10k | 100k |
|-------------|------------|------|------|------|------|
| Cap (µF) | 1~5.6 | 0.20 | 0.40 | 0.80 | 1.00 |
| | 6.8~180 | 0.40 | 0.75 | 0.90 | 1.00 |
| | ≥ 220 | 0.50 | 0.85 | 0.94 | 1.00 |

PART NUMBER SYSTEM (EXAMPLE : 200V 220µF)

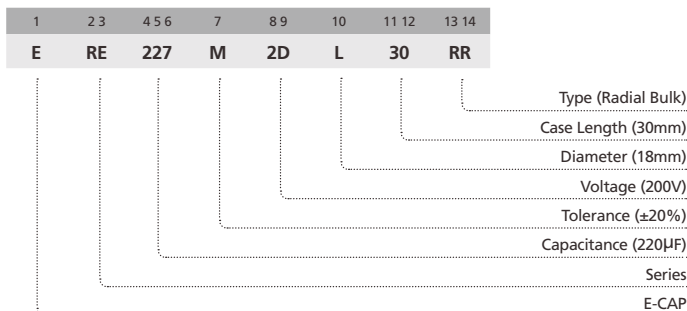

STANDARD RATINGS

| Voltage (Code) | | 160V (2C) | | 200V (2D) | | 250V (2E) | | 350V (2V) | |
|----------------|------|-----------|----------------|-----------|----------------|-----------|----------------|-----------|----------------|
| Cap. (µF) | Code | Case Size | Ripple Current | Case Size | Ripple Current | Case Size | Ripple Current | Case Size | Ripple Current |
| 6.8 | 685 | 8 x 12 | 160 | 8 x 12 | 160 | 8 x 12 | 150 | 10 x 16 | 220 |
| 10 | 106 | 10 x 16 | 250 | 10 x 16 | 250 | 10 x 12.5 | 228 | 10 x 16 | 254 |
| | | | | | | 10 x 20 | 280 | 10 x 20 | 280 |
| 22 | 226 | 10 x 20 | 500 | 10 x 20 | 500 | 12.5 x 20 | 600 | 12.5 x 20 | 350 |
| 33 | 336 | 10 x 20 | 500 | 12.5 x 20 | 600 | 12.5 x 20 | 600 | 16 x 20 | 500 |
| 47 | 476 | 12.5 x 20 | 660 | 12.5 x 20 | 660 | 12.5 x 25 | 720 | 16 x 25 | 660 |
| | | | | | | 16 x 20 | | 18 x 20 | |
| 68 | 686 | 12.5 x 25 | 760 | 12.5 x 25 | 760 | 16 x 25 | 920 | 16 x 30 | 850 |
| | | 16 x 20 | | 16 x 20 | | 18 x 20 | | 18 x 25 | |
| 100 | 107 | 16 x 25 | 1120 | 16 x 25 | 1120 | 16 x 30 | 1200 | | |
| | | 18 x 20 | | 18 x 20 | | 18 x 25 | | | |
| 150 | 157 | 16 x 30 | 1360 | 16 x 30 | 1360 | 18 x 30 | 1500 | | |
| | | 18 x 25 | | 18 x 25 | | | | | |
| 220 | 227 | 16 x 30 | 1400 | 18 x 30 | 1700 | | | | |
| | | 18 x 25 | | | | | | | |

Maximum Allowable Ripple Current (mArms) at 105°C 100kHz

Case Size Φ D x L (mm)

| Voltage (Code) | | 400V (2G) | | 450V (2W) | |
|----------------|------|-----------|----------------|-----------|----------------|
| Cap. (µF) | Code | Case Size | Ripple Current | Case Size | Ripple Current |
| 1 | 105 | 8 x 12 | 38 | | |
| 1.5 | 155 | 8 x 12 | 72 | | |
| | | 10 x 12.5 | 80 | | |
| 1.8 | 185 | 8 x 12 | 76 | | |
| | | 10 x 12.5 | 96 | | |
| 2.2 | 225 | 8 x 12 | 76 | | |
| | | 10 x 12.5 | 112 | | |
| 3.3 | 335 | 10 x 12.5 | 120 | | |
| 4.7 | 475 | 10 x 16 | 176 | 10 x 20 | 120 |
| 5.6 | 565 | 10 x 16 | 200 | 10 x 20 | 135 |
| 6.8 | 685 | 10 x 16 | 220 | 10 x 20 | 150 |
| 10 | 106 | 10 x 20 | 280 | 12.5 x 20 | 320 |
| 22 | 226 | 12.5 x 25 | 430 | 16 x 25 | 560 |
| | | 16 x 20 | | 18 x 20 | |
| 33 | 336 | 16 x 25 | 640 | 16 x 30 | 700 |
| | | 18 x 20 | | 18 x 25 | |
| 47 | 476 | 16 x 30 | 840 | 18 x 30 | 880 |
| | | 18 x 25 | | | |
| 68 | 686 | 18 x 30 | 1000 | | |

Maximum Allowable Ripple Current (mArms) at 105°C 100kHz

Case Size Φ D x L (mm)

Specifications are subject to change without notice. Should a safety or technical concern arise regarding the product, please be sure to contact our sales offices or agents immediately.

FEATURES

- High ripple current at high frequency, load life of 8,000~10,000 hours at 105°C.
- For electronic ballast, power supply input circuit.

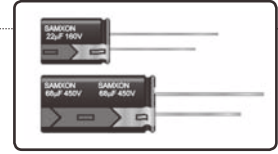

SPECIFICATIONS

| Item | Performance Characteristics | | | | | | | |
|---------------------------------|---|--|--------|---------|---|------|------|------|
| Operating Temperature Range | -40 to +105°C | | | | -25 to +105°C | | | |
| Rated Working Voltage Range | 160 to 400V | | | | 450 to 500V | | | |
| Nominal Capacitance Range | 1 to 330µF | | | | | | | |
| Capacitance Tolerance | ±20% at 120Hz, +20°C | | | | | | | |
| Leakage Current | I ≤ 0.02CV + 25 (µA) after 2 minutes application of rated working voltage at +20°C | | | | | | | |
| tan δ (120Hz, +20°C) | Working Voltage (V) | 160 | 200 | 250 | 350 | 400 | 450 | 500 |
| | tan δ (max.) | 0.15 | 0.15 | 0.15 | 0.20 | 0.20 | 0.20 | 0.20 |
| Low Temperature Characteristics | Impedance ratio max. at 120Hz | | | | | | | |
| | Rated Voltage (V) | 160 | 200 | 250 | 350 | 400 | 450 | 500 |
| | Z-25°C / Z+20°C | 3 | 3 | 3 | 5 | 5 | 6 | 12 |
| High Temperature Loading | Test time | ΦD | 8-10 | 12.5-18 | Post test requirements at +20°C | | | |
| | Load life | | 8,000h | 10,000h | Leakage current : ≤ Initial specified value | | | |
| | Test temperature | +105°C | | | Cap. change : within ±20% of the initial measured value | | | |
| Shelf Life | Test conditions | Rated DC working voltage with rated ripple current | | | tan δ : ≤ 200% of the initial specified value | | | |
| | At +105°C no voltage applied after 1,000 hours and then being stabilized at +20°C the capacitors shall meet the following limits | | | | | | | |
| | Leakage current : ≤ Initial specified value Cap. change : within ±20% of the initial measured value tan δ : ≤ 200% of the initial specified value | | | | | | | |
| Industrial Standard | JIS C - 5101-4 (IEC 60384-4) | | | | | | | |

CASE SIZE TABLE

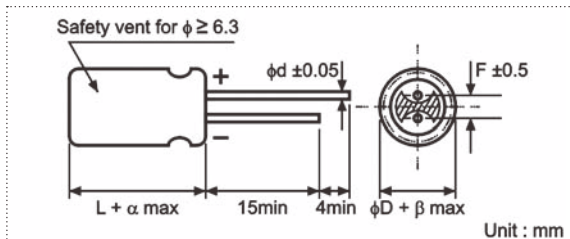

| | ΦD | 8 (L < 20) | 8 (L ≥ 20) | 10 | 12.5 | 16 | 18 |
|----|----|--------------|------------|--------------|------|-----|-----|
| F | | 3.5 | 3.5 | 5.0 | 5.0 | 7.5 | 7.5 |
| Φd | | 0.5 | 0.6 | 0.6 | 0.6 | 0.8 | 0.8 |
| α | | (L < 20) 1.5 | | (L ≥ 20) 2.0 | | | |
| β | | (D < 20) 0.5 | | (D ≥ 20) 1.0 | | | |

RIPPLE CURRENT MULTIPLIER

Frequency Coefficient

| Coefficient | Freq. (Hz) | 120 | 1k | 10k | 100k |
|-------------|------------|------|------|------|------|
| Cap (µF) | 1~5.6 | 0.20 | 0.40 | 0.80 | 1.00 |
| | 6.8~180 | 0.40 | 0.75 | 0.90 | 1.00 |
| | ≥220 | 0.50 | 0.85 | 0.94 | 1.00 |

PART NUMBER SYSTEM (EXAMPLE : 350V 33µF)

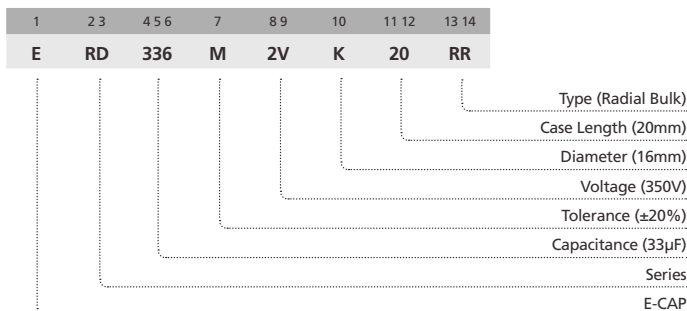

STANDARD RATINGS

| Voltage (Code) | | 160V (2C) | | 200V (2D) | | 250V (2E) | | 350V (2V) | |
|----------------|------|-----------|----------------|-----------|----------------|-----------|----------------|-----------|----------------|
| Cap. (μF) | Code | Case Size | Ripple Current | Case Size | Ripple Current | Case Size | Ripple Current | Case Size | Ripple Current |
| 10 | 106 | | | | | 10 x 16 | 342 | 10 x 20 | 350 |
| 22 | 226 | 10 x 20 | 500 | 10 x 16 | 544 | 10 x 16 | 508 | 12.5 x 20 | 480 |
| | | | | 10 x 20 | 600 | 10 x 20 | 560 | | |
| 33 | 336 | 10 x 20 | 580 | 10 x 20 | 650 | 12.5 x 20 | 710 | 16 x 20 | 640 |
| | | | | | | 16 x 15 | 728 | | |
| 47 | 476 | 10 x 20 | 750 | 10 x 20 | 697 | 12.5 x 20 | 834 | 16 x 25 | 800 |
| | | | | 12.5 x 20 | 790 | 12.5 x 25 | 920 | 18 x 20 | 800 |
| | | | | | | 16 x 20 | 990 | 16 x 30 | 1100 |
| 68 | 686 | 12.5 x 20 | 950 | 12.5 x 25 | 950 | 16 x 20 | 1000 | 18 x 20 | 910 |
| | | | | 16 x 20 | 1000 | | | 18 x 25 | 1000 |
| 82 | 826 | 12.5 x 25 | 1060 | 16 x 20 | 1100 | 16 x 25 | 1200 | 18 x 25 | 1100 |
| | | | | | | 18 x 20 | 1200 | | |
| 100 | 107 | 12.5 x 25 | 1170 | 16 x 25 | 1300 | 16 x 25 | 1385 | 18 x 25 | 1110 |
| | | 16 x 20 | 1280 | 18 x 20 | 1280 | 16 x 30 | 1500 | 18 x 30 | 1200 |
| | | | | | | 18 x 25 | 1500 | | |
| 150 | 157 | 16 x 25 | 1400 | 16 x 25 | 1400 | 18 x 25 | 1665 | | |
| | | 18 x 20 | 1400 | | | 18 x 30 | 1800 | | |
| 220 | 227 | 16 x 30 | 1700 | 18 x 30 | 2000 | 18 x 40 | 2100 | | |
| | | 18 x 25 | 1500 | | | | | | |
| 330 | 337 | 18 x 30 | 2000 | 18 x 40 | 2400 | | | | |

Maximum Allowable Ripple Current (mArms) at 105°C 100kHz

Case Size Φ D x L (mm)

| Voltage (Code) | | 400V (2G) | | 450V (2W) | | 500V (2H) | |
|----------------|------|-----------|----------------|-----------|----------------|-----------|----------------|
| Cap. (μF) | Code | Case Size | Ripple Current | Case Size | Ripple Current | Case Size | Ripple Current |
| 1 | 105 | 6.3 x 11 | 34 | | | | |
| | | 8 x 12 | 41 | | | | |
| 1.5 | 155 | 8 x 12 | 77 | | | | |
| | | 10 x 12.5 | 86 | | | | |
| 1.8 | 185 | 8 x 12 | 81 | | | | |
| | | 10 x 12.5 | 103 | | | | |
| 2.2 | 225 | 8 x 12 | 81 | | | | |
| | | 10 x 12.5 | 120 | | | | |
| 3.3 | 335 | 8 x 12 | 110 | | | | |
| | | 10 x 12.5 | 128 | | | | |
| 4.7 | 475 | 8 x 12 | 146 | 10 x 20 | 128 | | |
| | | 10 x 16 | 188 | | | | |
| 5.6 | 565 | 10 x 16 | 214 | 10 x 20 | 144 | | |
| | | 10 x 12.5 | 207 | | | | |
| 6.8 | 685 | 10 x 16 | 230 | | | | |
| | | 10 x 16 | 276 | 10 x 20 | 309 | | |
| 10 | 106 | 10 x 20 | 300 | 12.5 x 20 | 350 | 12.5 x 20 | 280 |
| | | | | 12.5 x 20 | 508 | 12.5 x 25 | 390 |
| 15 | 156 | 12.5 x 20 | 410 | 12.5 x 25 | 560 | 16 x 20 | 390 |
| | | | | 12.5 x 20 | 590 | 16 x 25 | 500 |
| 22 | 226 | 12.5 x 25 | 500 | 12.5 x 25 | 651 | 18 x 20 | 500 |
| | | 16 x 20 | 600 | 16 x 20 | 680 | | |
| | | | | 12.5 x 25 | 683 | | |
| 33 | 336 | 12.5 x 25 | 698 | 16 x 25 | 785 | 16 x 30 | 630 |
| | | | | | 975* | | |
| | | 16 x 20 | 730 | 16 x 30 | 850 | 18 x 25 | 630 |
| | | | | 18 x 25 | 850 | | |
| 47 | 476 | 16 x 20 | 764 | 16 x 25 | 1250* | | |
| | | 16 x 25 | 840 | 16 x 30 | 936 | 18 x 30 | 750 |
| | | 18 x 20 | 840 | 18 x 30 | 1000 | | |
| | | | | 18 x 24 | 1450* | | |
| 68 | 686 | 18 x 25 | 1110 | 18 x 25 | 1054 | 18 x 35 | 890 |
| | | 18 x 30 | 1200 | | 1550* | | |
| | | | | 18 x 30 | 1140 | | |
| 82 | 826 | 18 x 25 | 1550 | | | 18 x 45 | 980 |
| | | 18 x 40 | 1500 | | | | |
| 120 | 127 | 18 x 35 | 2250* | | | | |

Maximum Allowable Ripple Current (mArms) at 105°C 100kHz

Case Size Φ D x L (mm)

* Special item with higher ripple current.

Specifications are subject to change without notice. Should a safety or technical concern arise regarding the product, please be sure to contact our sales offices or agents immediately.

FEATURES

- High ripple current at high frequency, load life of 10,000~12,000 hours at 105°C.
- For electronic ballast.



SPECIFICATIONS

| Item | Performance Characteristics | | | | | | | |
|---------------------------------|--|--|---|---------|---------------|---|------|------|
| Operating Temperature Range | -40 to +105°C | | | | -25 to +105°C | | | |
| Rated Working Voltage Range | 160 to 400V | | | | 450 to 500V | | | |
| Nominal Capacitance Range | 1 to 220µF | | | | | | | |
| Capacitance Tolerance | ±20% at 120Hz, +20°C | | | | | | | |
| Leakage Current | I ≤ 0.02CV + 25 (µA) after 2 minutes application of rated working voltage at +20°C | | | | | | | |
| tan δ (120Hz, +20°C) | Working Voltage (V) | 160 | 200 | 250 | 350 | 400 | 450 | 500 |
| | tan δ (max.) | 0.15 | 0.15 | 0.15 | 0.20 | 0.20 | 0.20 | 0.20 |
| Low Temperature Characteristics | Impedance ratio max. at 120Hz | | | | | | | |
| | Rated Voltage (V) | 160 | 200 | 250 | 350 | 400 | 450 | 500 |
| | Z-25°C / Z+20°C | 3 | 3 | 3 | 5 | 5 | 6 | 12 |
| High Temperature Loading | Test time | ΦD | 8-10 | 12.5-18 | 500V | Post test requirements at +20°C | | |
| | | Load life | 10,000h | 12,000h | 10,000h | Leakage current : ≤ Initial specified value | | |
| | Test temperature : +105°C | Test conditions : Rated DC working voltage with rated ripple current | tan δ : ≤ 200% of the initial specified value | | | Cap. change : within ±20% of the initial measured value | | |
| Shelf Life | At +105°C no voltage applied after 1,000 hours and then being stabilized at +20°C the capacitors shall meet the following limits | | | | | | | |
| | Leakage current : ≤ Initial specified value | | | | | | | |
| | Cap. change : within ±20% of the initial measured value tan δ : ≤ 200% of the initial specified value | | | | | | | |
| Industrial Standard | JIS C - 5101-4 (IEC 60384-4) | | | | | | | |

CASE SIZE TABLE



| ΦD | 8 (L < 20) | 8 (L ≥ 20) | 10 | 12.5 | 16 | 18 |
|----|--------------|------------|-----|--------------|-----|-----|
| F | 3.5 | 3.5 | 5.0 | 5.0 | 7.5 | 7.5 |
| Φd | 0.5 | 0.6 | 0.6 | 0.6 | 0.8 | 0.8 |
| α | (L < 20) 1.5 | | | (L ≥ 20) 2.0 | | |
| β | (D < 20) 0.5 | | | (D ≥ 20) 1.0 | | |

RIPPLE CURRENT MULTIPLIER

Frequency Coefficient

| Coefficient | 120 | 1k | 10k | 100k |
|-------------|------|------|------|------|
| 1-5.6 | 0.20 | 0.40 | 0.80 | 1.00 |
| 6.8-180 | 0.40 | 0.75 | 0.90 | 1.00 |
| ≥ 220 | 0.50 | 0.85 | 0.94 | 1.00 |

PART NUMBER SYSTEM (EXAMPLE : 160V 22µF)



STANDARD RATINGS

| Voltage (Code) | | 160V (2C) | | 200V (2D) | | 250V (2E) | | 350V (2V) | |
|----------------|------|-----------|----------------|-----------|----------------|-----------|----------------|-----------|----------------|
| Cap. (µF) | Code | Case Size | Ripple Current | Case Size | Ripple Current | Case Size | Ripple Current | Case Size | Ripple Current |
| 6.8 | 685 | | | | | | | 10 x 16 | 220 |
| 10 | 106 | 10 x 16 | 250 | 10 x 16 | 250 | 10 x 20 | 300 | 10 x 20 | 280 |
| 22 | 226 | 10 x 20 | 500 | 10 x 20 | 500 | 12.5 x 20 | 600 | 12.5 x 25 | 350 |
| 33 | 336 | 10 x 20 | 565 | 12.5 x 20 | 600 | 12.5 x 20 | 630 | 16 x 20 | 600 |
| 47 | 476 | 12.5 x 20 | 725 | 12.5 x 20 | 780 | 12.5 x 25 | 720 | 16 x 25 | 700 |
| | | | | | | 16 x 20 | 750 | 18 x 20 | 750 |
| 68 | 686 | 12.5 x 25 | 950 | 12.5 x 25 | 950 | 16 x 25 | 1000 | 16 x 30 | 1100 |
| | | 16 x 20 | 970 | 16 x 20 | 970 | 18 x 20 | 920 | 18 x 25 | 875 |
| 100 | 107 | 16 x 25 | 1280 | 16 x 25 | 1280 | 16 x 30 | 1400 | | |
| | | 18 x 20 | 1180 | 18 x 20 | 1180 | 18 x 25 | 1345 | | |
| 150 | 157 | 16 x 30 | 1360 | 16 x 30 | 1360 | 18 x 30 | 1500 | | |
| | | 18 x 25 | 1360 | 18 x 25 | 1360 | | | | |
| 220 | 227 | 16 x 30 | 1400 | 18 x 30 | 1700 | | | | |
| | | 18 x 25 | 1400 | | | | | | |

Maximum Allowable Ripple Current (mArms) at 105°C 100kHz

Case Size Φ D x L (mm)

| Voltage (Code) | | 400V (2G) | | 450V (2W) | | 500V (2H) | |
|----------------|------|-----------|----------------|-----------|----------------|-----------|----------------|
| Cap. (µF) | Code | Case Size | Ripple Current | Case Size | Ripple Current | Case Size | Ripple Current |
| 1 | 105 | 8 x 12 | 38 | | | | |
| 1.5 | 155 | 8 x 12 | 72 | | | | |
| | | 10 x 12.5 | 80 | | | | |
| 1.8 | 185 | 8 x 12 | 76 | | | | |
| | | 10 x 12.5 | 96 | | | | |
| 2.2 | 225 | 8 x 12 | 76 | | | | |
| | | 10 x 12.5 | 112 | | | | |
| 3.3 | 335 | 10 x 12.5 | 120 | | | | |
| 4.7 | 475 | 10 x 16 | 176 | 10 x 20 | 120 | | |
| 5.6 | 565 | 10 x 16 | 200 | 10 x 20 | 135 | | |
| 6.8 | 685 | 10 x 16 | 220 | 10 x 20 | 150 | | |
| 10 | 106 | 10 x 20 | 280 | 12.5 x 20 | 320 | 12.5 x 20 | 240 |
| | | | | 16 x 25 | 560 | 12.5 x 25 | 300 |
| 15 | 156 | | | 18 x 20 | 560 | 16 x 20 | 300 |
| | | | | | | | |
| 22 | 226 | 12.5 x 25 | 430 | 16 x 25 | 560 | 16 x 25 | 430 |
| | | 16 x 20 | 600 | 18 x 20 | 560 | 18 x 20 | 430 |
| 33 | 336 | 16 x 25 | 640 | 16 x 30 | 700 | 16 x 30 | 540 |
| | | 18 x 20 | 640 | 18 x 25 | 700 | 18 x 25 | 540 |
| 47 | 476 | 16 x 30 | 840 | 18 x 30 | 900 | 18 x 30 | 640 |
| | | 18 x 25 | 840 | | | | |
| 68 | 686 | 18 x 30 | 1000 | | | 18 x 35 | 750 |
| 82 | 826 | | | | | 18 x 45 | 800 |

Maximum Allowable Ripple Current (mArms) at 105°C 100kHz

Case Size Φ D x L (mm)

Specifications are subject to change without notice. Should a safety or technical concern arise regarding the product, please be sure to contact our sales offices or agents immediately.

FEATURES

- Wide operating temperature range, it as long load life product at 125°C.
- Suitable for use in DC or pulse circuits in various electronic and industrial.



SPECIFICATIONS

| Item | Performance Characteristics | | | | | |
|--|--|--|--------|--------|---|------|
| Operating Temperature Range | -40 to +125°C | | | | | |
| Rated Working Voltage Range | 10 to 50V | | | | | |
| Nominal Capacitance Range | 3.3 to 3900µF | | | | | |
| Capacitance Tolerance | ±20% at 120Hz, +20°C | | | | | |
| Leakage Current | I ≤ 0.03CV or 4 (µA) whichever is greater measured after 1 minute application of rated working voltage at +20°C | | | | | |
| tan δ (120Hz, +20°C) | Working Voltage (V) | 10 | 16 | 25 | 35 | 50 |
| | tan δ (max.) | 0.22 | 0.18 | 0.16 | 0.14 | 0.12 |
| For capacitance value >1000µF, add 0.02 per another 1000µF | | | | | | |
| Low Temperature Characteristics | Impedance ratio max. at 120Hz | | | | | |
| | Working Voltage (V) | 10 | 16 | 25 | 35 | 50 |
| | Z-25°C / Z+20°C | 3 | 2 | 2 | 2 | 2 |
| Z-40°C / Z+20°C | | 6 | 4 | 4 | 4 | 4 |
| High Temperature Loading | Test time | ΦD | <8 | ≥8 | Post test requirements at +20 | |
| | Load life | | 1,000h | 2,000h | Leakage current : ≤Initial specified value | |
| | Test temperature | +125°C | | | Cap. change : within ±20% of the initial measured value | |
| Test conditions | | Rated DC working voltage with rated ripple current | | | tan δ : ≤200% of the initial specified value | |
| Shelf Life | At +125°C no voltage applied after 1,000 hours and then being stabilized at +20°C the capacitors shall meet the following limits | | | | | |
| | Leakage current : ≤Initial specified value | | | | | |
| | Cap. change : within ±20% of the initial measured value | | | | | |
| | tan δ : ≤200% of the initial specified value | | | | | |
| Industrial Standard | JIS C - 5101-4 (IEC 60384-4) | | | | | |

CASE SIZE TABLE



| ΦD | 5 | 6.3 | 8 (L < 20) | 8 (L ≥ 20) | 10 | 12.5 | 16 | 18 |
|----|--------------|-----|------------|--------------|-----|------|-----|-----|
| F | 2.0 | 2.5 | 3.5 | 3.5 | 5.0 | 5.0 | 7.5 | 7.5 |
| φd | 0.5 | 0.5 | 0.5 | 0.6 | 0.6 | 0.6 | 0.8 | 0.8 |
| α | (L < 20) 1.5 | | | (L ≥ 20) 2.0 | | | | |
| β | (D < 20) 0.5 | | | (D ≥ 20) 1.0 | | | | |

RIPPLE CURRENT MULTIPLIER

Frequency Coefficient

| Rated Voltage | Coefficient Cap (µF) | Freq. (Hz) | | | | |
|---------------|-------------------------|------------|------|------|------|----------|
| | | 50 | 120 | 300 | 1k | 10k~100k |
| 10~50V | ≤47 | 0.75 | 1.00 | 1.35 | 1.57 | 2.00 |
| | 100~470 | 0.80 | 1.00 | 1.23 | 1.34 | 1.50 |
| | ≥560 | 0.85 | 1.00 | 1.10 | 1.13 | 1.15 |

PART NUMBER SYSTEM (EXAMPLE : 16V 330µF)

| 1 | 2 3 | 4 5 6 | 7 | 8 9 | 10 | 11 12 | 13 14 |
|---------------------|-----|-------|---|-----|----|-------|-------|
| E | BD | 337 | M | 1C | F | 12 | RR |
| Type (Radial Bulk) | | | | | | | |
| Case Length (12mm) | | | | | | | |
| Diameter (8mm) | | | | | | | |
| Voltage (16V) | | | | | | | |
| Tolerance (±20%) | | | | | | | |
| Capacitance (330µF) | | | | | | | |
| Series | | | | | | | |
| E-CAP | | | | | | | |

STANDARD RATINGS

| Voltage (Code) | | 10V (1A) | | 16V (1C) | | 25V (1E) | | 35V (1E) | | 50V (1H) | |
|----------------|------|-----------|----------------|-----------|----------------|-----------|----------------|-----------|----------------|-----------|----------------|
| Cap. (µF) | Code | Case Size | Ripple Current | Case Size | Ripple Current | Case Size | Ripple Current | Case Size | Ripple Current | Case Size | Ripple Current |
| 3.3 | 335 | | | | | | | | | 5 x 11 | 21 |
| 4.7 | 475 | | | | | | | | | 5 x 11 | 26 |
| 10 | 106 | | | | | | | | | 5 x 11 | 38 |
| 22 | 226 | | | | | | | 5 x 11 | 47 | 5 x 11 | 55 |
| 33 | 336 | | | | | 5 x 11 | 53 | 5 x 11 | 56 | 6.3 x 11 | 81 |
| 47 | 476 | | | 5 x 11 | 56 | 5 x 11 | 59 | 6.3 x 11 | 84 | 6.3 x 11 | 93 |
| 100 | 107 | 5 x 11 | 74 | 5 x 11 | 88 | 6.3 x 11 | 111 | 6.3 x 11 | 118 | 8 x 12 | 160 |
| 220 | 227 | 6.3 x 11 | 135 | 6.3 x 11 | 149 | 8 x 12 | 200 | 10 x 12.5 | 240 | | |
| 330 | 337 | 6.3 x 11 | 167 | 8 x 12 | 221 | 8 x 12 | 238 | | | | |
| 470 | 477 | 8 x 12 | 237 | 8 x 12 | 256 | 10 x 16 | 366 | | | | |
| 1000 | 108 | | | | | 10 x 20 | 575 | | | | |
| 2200 | 228 | | | | | 12.5 x 25 | 908 | | | | |
| 3900 | 398 | | | | | 16 x 30 | 1356 | | | | |

Maximum Allowable Ripple Current (mArms) at 125°C 120Hz

Case Size Φ D x L (mm)

Specifications are subject to change without notice. Should a safety or technical concern arise regarding the product, please be sure to contact our sales offices or agents immediately.

FEATURES

- High temperature, high ripple current at high frequency, load life of 1,000~4,000 hours at 130°C.
- Specially designed for electronic ballast and energy saving lamp.



SPECIFICATIONS

| Item | Performance Characteristics | | | | | | | | | | | |
|---|--|--|--|--|--|--|--|--|--|--|--|--|
| Operating Temperature Range | -40 to +130°C | -25 to +130°C | | | | | | | | | | |
| Rated Working Voltage Range | 10 to 100V | 200 to 450V | | | | | | | | | | |
| Nominal Capacitance Range | 1 to 4700µF | | | | | | | | | | | |
| Capacitance Tolerance | ±20% at 120Hz, +20°C | | | | | | | | | | | |
| Leakage Current | I ≤ 0.01CV or 3 (µA) whichever is greater measured after 2 minutes application of rated working voltage at +20°C | I ≤ 0.02CV + 25 (µA) after 2 minutes application of rated working voltage at +20°C | | | | | | | | | | |
| tan δ (120Hz, +20°C) | Working Voltage (V) | 10 16 25 35 50 63 100 200 250 350 400 450 | | | | | | | | | | |
| | tan δ (max.) | 0.20 0.16 0.14 0.12 0.10 0.09 0.15 0.15 0.15 0.20 0.20 0.20 | | | | | | | | | | |
| For capacitance > 1000µF, add 0.02 per another 1000µF | | | | | | | | | | | | |
| Low Temperature Characteristics | Impedance ratio max. at 120Hz | | | | | | | | | | | |
| | Working Voltage (V) | 10 16 25 35 50 63 100 200 250 350 400 450 | | | | | | | | | | |
| | Z-25°C / Z+20°C | 3 2 2 2 2 2 2 3 3 5 6 6 | | | | | | | | | | |
| Z-40°C / Z+20°C | | | 6 4 3 3 3 3 3 - - - - - | | | | | | | | | |
| High Temperature Loading | Test time | ΦD 6.3 8-10 ≥12.5 | Post test requirements at +20°C | | | | | | | | | |
| | Load life | 1,000h 2,000h 4,000h | Leakage current : ≤ Initial specified value | | | | | | | | | |
| | Test temperature | +130°C | Cap. change : within ±30% of the initial measured value | | | | | | | | | |
| | Test conditions | Rated DC working voltage with rated ripple current | tan δ : ≤ 300% of the initial specified value (200~450V within 200%) | | | | | | | | | |
| Shelf Life | At +105°C no voltage applied after 1,000 hours and then being stabilized at +20°C the capacitors shall meet the following limits | | | | | | | | | | | |
| | Leakage current | : ≤ Initial specified value | | | | | | | | | | |
| | Cap. change | : within ±30% of the initial measured value | | | | | | | | | | |
| | tan δ | : ≤ 300% of the initial specified value (200~450V within 200%) | | | | | | | | | | |
| Industrial Standard | JIS C - 5101-4 (IEC 60384-4) | | | | | | | | | | | |

CASE SIZE TABLE



| ΦD | 6.3 | 8(L<20) | 8(L≥20) | 10 | 12.5 | 16 | 18 |
|----|--------------|---------|---------|--------------|------|-----|-----|
| F | 2.5 | 3.5 | 3.5 | 5.0 | 5.0 | 7.5 | 7.5 |
| Φd | 0.5 | 0.5 | 0.6 | 0.6 | 0.6 | 0.8 | 0.8 |
| α | (L < 20) 1.5 | | | (L ≥ 20) 2.0 | | | |
| β | (D < 20) 0.5 | | | (D ≥ 20) 1.0 | | | |

RIPPLE CURRENT MULTIPLIER

Frequency Coefficient

| Rated Voltage | Coefficient Cap (µF) | Freq. (Hz) | | | |
|---------------|-------------------------|------------|------|------|------|
| | | 120 | 1k | 10k | 100k |
| 10~100V | 4.7 | 0.42 | 0.60 | 0.80 | 1.00 |
| | 10~33 | 0.55 | 0.75 | 0.90 | 1.00 |
| | 47~330 | 0.70 | 0.85 | 0.95 | 1.00 |
| | 470~1500 | 0.75 | 0.90 | 0.98 | 1.00 |
| | 2200~4700 | 0.80 | 0.95 | 1.00 | 1.00 |
| 200~450V | 1~5.6 | 0.20 | 0.40 | 0.80 | 1.00 |
| | 6.8~15 | 0.30 | 0.60 | 0.90 | 1.00 |
| | 22~33 | 0.50 | 0.80 | 0.90 | 1.00 |

PART NUMBER SYSTEM (EXAMPLE : 16V 1000µF)

| | | | | | | | |
|---|----|-----|---|----|----|-------|-------|
| 1 | 23 | 456 | 7 | 89 | 10 | 11 12 | 13 14 |
| E | RA | 108 | M | 1C | G | 20 | RR |



STANDARD RATINGS

| Voltage (Code) | | 10V (1A) | | | 16V (1C) | | |
|----------------|------|-----------|-----------|----------------|-----------|-----------|----------------|
| Cap. (μF) | Code | Case Size | Impedance | Ripple Current | Case Size | Impedance | Ripple Current |
| 330 | 337 | 8 x 12 | 0.220 | 360 | 8 x 12 | 0.220 | 360 |
| 470 | 477 | 10 x 12.5 | 0.150 | 620 | 10 x 12.5 | 0.150 | 620 |
| 1000 | 108 | 10 x 20 | 0.073 | 960 | 10 x 20 | 0.073 | 960 |
| 2200 | 228 | 12.5 x 25 | 0.040 | 1430 | 12.5 x 25 | 0.040 | 1430 |
| 3300 | 338 | 16 x 25 | 0.038 | 1900 | 16 x 30 | 0.034 | 2300 |
| 4700 | 478 | 16 x 30 | 0.034 | 2300 | 16 x 35 | 0.031 | 2550 |

Maximum Allowable Ripple Current (mArms) at 130°C 100kHz

Case Size ΦD x L (mm)

Maximum Impedance (Ω) at 20°C 100kHz

| Voltage (Code) | | 25V (1E) | | | 35V (1V) | | |
|----------------|------|-----------|-----------|----------------|-----------|-----------|----------------|
| Cap. (μF) | Code | Case Size | Impedance | Ripple Current | Case Size | Impedance | Ripple Current |
| 100 | 107 | | | | 8 x 12 | 0.220 | 360 |
| 220 | 227 | 8 x 12 | 0.220 | 360 | 10 x 12.5 | 0.150 | 620 |
| 330 | 337 | 10 x 12.5 | 0.150 | 620 | 10 x 16 | 0.100 | 800 |
| 470 | 477 | 10 x 16 | 0.100 | 800 | 10 x 20 | 0.073 | 960 |
| 1000 | 108 | 12.5 x 20 | 0.055 | 1100 | 12.5 x 25 | 0.040 | 1430 |
| 2200 | 228 | 16 x 30 | 0.034 | 2300 | 16 x 35 | 0.031 | 2550 |
| 3300 | 338 | 16 x 35 | 0.031 | 2550 | 18 x 35 | 0.028 | 2800 |

Maximum Allowable Ripple Current (mArms) at 130°C 100kHz

Case Size ΦD x L (mm)

Maximum Impedance (Ω) at 20°C 100kHz

| Voltage (Code) | | 50V (1H) | | | 63V (1J) | | | 100V (2A) | | |
|----------------|------|-----------|-----------|----------------|-----------|-----------|----------------|-----------|-----------|----------------|
| Cap. (μF) | Code | Case Size | Impedance | Ripple Current | Case Size | Impedance | Ripple Current | Case Size | Impedance | Ripple Current |
| 4.7 | 475 | 8 x 12 | 0.850 | 100 | | | | 8 x 12 | 1.300 | 100 |
| 10 | 106 | 8 x 12 | 0.600 | 200 | | | | 8 x 12 | 1.000 | 200 |
| 22 | 226 | 8 x 12 | 0.350 | 260 | | | | 8 x 12 | 0.670 | 220 |
| 33 | 336 | 8 x 12 | 0.280 | 300 | 8 x 12 | 0.400 | 250 | 10 x 12.5 | 0.450 | 260 |
| 47 | 476 | 8 x 12 | 0.280 | 300 | 10 x 12.5 | 0.270 | 400 | 10 x 16 | 0.330 | 330 |
| 100 | 107 | 10 x 12.5 | 0.180 | 520 | 10 x 16 | 0.200 | 450 | 12.5 x 20 | 0.170 | 670 |
| 220 | 227 | 10 x 20 | 0.082 | 890 | 12.5 x 20 | 0.100 | 820 | 16 x 25 | 0.130 | 1100 |
| 330 | 337 | 12.5 x 20 | 0.065 | 1000 | 12.5 x 25 | 0.072 | 1000 | 16 x 30 | 0.100 | 1300 |
| 470 | 477 | 12.5 x 25 | 0.051 | 1200 | 16 x 25 | 0.069 | 1500 | 18 x 30 | 0.092 | 1600 |
| 1000 | 108 | 16 x 30 | 0.037 | 2180 | 16 x 30 | 0.056 | 1850 | | | |
| 1500 | 158 | | | | 18 x 40 | 0.043 | 2350 | | | |
| 2200 | 228 | 18 x 40 | 0.029 | 2800 | | | | | | |

Maximum Allowable Ripple Current (mArms) at 130°C 100kHz

Case Size ΦD x L (mm)

Maximum Impedance (Ω) at 20°C 100kHz

Specifications are subject to change without notice. Should a safety or technical concern arise regarding the product, please be sure to contact our sales offices or agents immediately.

STANDARD RATINGS

| Voltage (Code) | | 200V (2D) | | 250V (2E) | |
|----------------|------|-----------|----------------|-----------|----------------|
| Cap. (µF) | Code | Case Size | Ripple Current | Case Size | Ripple Current |
| 4.7 | 475 | 6.3 x 11 | 100 | 8 x 12 | 120 |
| | | 8 x 12 | 120 | | |
| 5.6 | 565 | 8 x 12 | 130 | 8 x 16 | 180 |
| | | 8 x 16 | 180 | | |
| 6.8 | 685 | 8 x 12 | 130 | 8 x 16 | 180 |
| | | 8 x 16 | 180 | | |
| 8.2 | 825 | 10 x 16 | 200 | 10 x 16 | 200 |
| 10 | 106 | 8 x 16 | 200 | 8 x 20 | 240 |
| | | 8 x 20 | 240 | | |
| 15 | 156 | 8 x 16 | 200 | 10 x 16 | 240 |
| | | 8 x 20 | 240 | | |
| 22 | 226 | 8 x 20 | 300 | 10 x 20 | 260 |
| | | 10 x 16 | 240 | | |
| 33 | 336 | 10 x 20 | 320 | 12.5 x 20 | 350 |

Maximum Allowable Ripple Current (mArms) at 130°C 100kHz

Case Size Φ D x L (mm)

| Voltage (Code) | | 350V (2V) | | 400V (2G) | | 450V (2W) | |
|----------------|------|-----------|----------------|-----------|----------------|-----------|----------------|
| Cap. (µF) | Code | Case Size | Ripple Current | Case Size | Ripple Current | Case Size | Ripple Current |
| 1 | 105 | 6.3 x 11 | 60 | 6.3 x 11 | 60 | 8 x 12 | 59 |
| | | 8 x 12 | 65 | 8 x 12 | 65 | | |
| 1.5 | 155 | 8 x 12 | 75 | 8 x 12 | 75 | 8 x 12 | 68 |
| | | 8 x 16 | 80 | 8 x 16 | 80 | | |
| 1.8 | 185 | 8 x 12 | 75 | 8 x 12 | 75 | 8 x 12 | 68 |
| | | 8 x 16 | 85 | 8 x 16 | 85 | | |
| 2.2 | 225 | 8 x 12 | 75 | 8 x 12 | 75 | 8 x 12 | 68 |
| | | 8 x 16 | 90 | 8 x 16 | 90 | | |
| 2.7 | 275 | 8 x 20 | 110 | 8 x 20 | 110 | 8 x 16 | 88 |
| | | 8 x 16 | 95 | 8 x 16 | 95 | | |
| 3.3 | 335 | 8 x 16 | 100 | 8 x 16 | 100 | 8 x 16 | 90 |
| | | 8 x 20 | 120 | 8 x 20 | 120 | | |
| 4.7 | 475 | 8 x 20 | 120 | 8 x 20 | 120 | 10 x 16 | 112 |
| | | 10 x 16 | 125 | 10 x 16 | 125 | | |
| 5.6 | 565 | 10 x 16 | 130 | 10 x 16 | 130 | 10 x 16 | 115 |
| | | 10 x 20 | 145 | 10 x 20 | 145 | | |
| 6.8 | 685 | 10 x 20 | 150 | 10 x 20 | 150 | 10 x 20 | 135 |
| 8.2 | 825 | 10 x 20 | 168 | 10 x 20 | 168 | 10 x 20 | 150 |
| 10 | 106 | 12.5 x 20 | 186 | 12.5 x 20 | 186 | 12.5 x 20 | 170 |
| 15 | 156 | 12.5 x 25 | 226 | 12.5 x 25 | 226 | 12.5 x 25 | 200 |
| 22 | 226 | 16 x 25 | 283 | 16 x 25 | 283 | | |
| 33 | 336 | 16 x 30 | 375 | 16 x 30 | 375 | | |

Maximum Allowable Ripple Current (mArms) at 130°C 100kHz

Case Size Φ D x L (mm)

Specifications are subject to change without notice. Should a safety or technical concern arise regarding the product, please be sure to contact our sales offices or agents immediately.

FEATURES

- High temperature, high ripple current at high frequency, load life of 3,000~4,000 hours at 130°C.
- Specially designed for electronic ballast and energy saving lamp.



SPECIFICATIONS

| Item | Performance Characteristics | | | | | | |
|---------------------------------|--|--|--------|---|---------------|------|--|
| Operating Temperature Range | -40 to +130°C | | | | -25 to +130°C | | |
| Rated Working Voltage Range | 160 to 400V | | | | 450V | | |
| Nominal Capacitance Range | 1.5 to 100μF | | | | | | |
| Capacitance Tolerance | ±20% at 120Hz, +20°C | | | | | | |
| Leakage Current | I ≤ 0.02CV + 25 (μA) after 2 minutes application of rated working voltage at +20°C | | | | | | |
| tan δ (120Hz, +20°C) | Working Voltage (V) | 160 | 200 | 250 | 350 | 400 | 450 |
| | tan δ (max.) | 0.15 | 0.15 | 0.15 | 0.20 | 0.20 | 0.20 |
| Low Temperature Characteristics | Impedance ratio max. at 120Hz | | | | | | |
| | Rated Voltage (V) | 160 | 200 | 250 | 350 | 400 | 450 |
| | Z-25°C / Z+20°C | 3 | 3 | 3 | 5 | 5 | 6 |
| High Temperature Loading | Test time | ΦD ≤ 12.5 | > 12.5 | Post test requirements at +20°C | | | |
| | Load life | 3,000h | 4,000h | Leakage current : ≤ Initial specified value Cap. change : within ±30% of the initial measured value tan δ : ≤ 300% of the initial specified value | | | |
| Shelf Life | Test temperature | +130°C | | | | | Cap. change : within ±30% of the initial measured value |
| | Test conditions | Rated DC working voltage with rated ripple current | | | | | tan δ : ≤ 300% of the initial specified value |
| Shelf Life | At +105°C no voltage applied after 1,000 hours and then being stabilized at +20°C the capacitors shall meet the following limits | | | | | | |
| | Leakage current | ≤ Initial specified value | | | | | Cap. change : within ±30% of the initial measured value tan δ : ≤ 300% of the initial specified value |
| Industrial Standard | JIS C - 5101-4 (IEC 60384-4) | | | | | | |

CASE SIZE TABLE



| ΦD | 8 (L < 20) | 8 (L ≥ 20) | 10 | 12.5 | 16 | 18 |
|----|--------------|------------|--------------|------|-----|-----|
| F | 3.5 | 3.5 | 5.0 | 5.0 | 7.5 | 7.5 |
| Φd | 0.5 | 0.6 | 0.6 | 0.6 | 0.8 | 0.8 |
| α | (L < 20) 1.5 | | (L ≥ 20) 2.0 | | | |
| β | (D < 20) 0.5 | | (D ≥ 20) 1.0 | | | |

RIPPLE CURRENT MULTIPLIER

Frequency Coefficient

| Coefficient | 120 | 1k | 10k | 100k |
|-------------|------|------|------|------|
| Cap (μF) | | | | |
| 1.5~5.6 | 0.20 | 0.40 | 0.80 | 1.00 |
| 6.8~100 | 0.40 | 0.75 | 0.90 | 1.00 |

PART NUMBER SYSTEM (EXAMPLE : 200V 100μF)

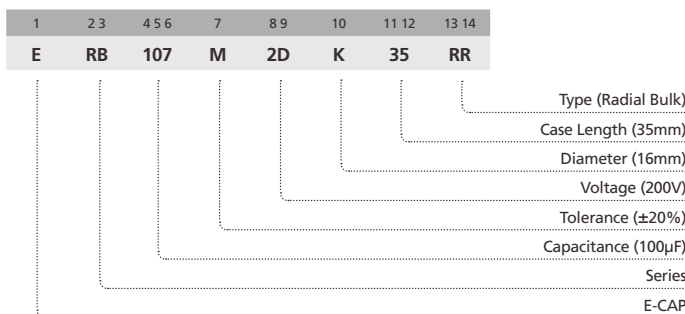

STANDARD RATINGS

| Voltage (Code) | | 160V (2C) | | 200V (2D) | | 250V (2E) | | 350V (2V) | |
|----------------|------|-----------|----------------|-----------|----------------|-----------|----------------|-----------|----------------|
| Cap. (µF) | Code | Case Size | Ripple Current | Case Size | Ripple Current | Case Size | Ripple Current | Case Size | Ripple Current |
| 1.8 | 185 | | | | | | | 10 x 16 | 62 |
| 2.2 | 225 | | | | | | | 10 x 16 | 70 |
| 2.8 | 285 | | | | | | | 10 x 16 | 76 |
| 3.3 | 335 | | | | | | | 10 x 16 | 84 |
| 4.7 | 475 | | | | | 10 x 16 | 88 | 10 x 20 | 105 |
| 5.6 | 565 | | | | | 10 x 16 | 88 | 12.5 x 20 | 121 |
| 6.8 | 685 | | | | | 10 x 16 | 96 | 12.5 x 20 | 176 |
| 8.2 | 825 | 10 x 16 | 96 | 10 x 16 | 100 | 10 x 16 | 104 | 12.5 x 20 | 192 |
| 10 | 106 | 10 x 16 | 200 | 10 x 16 | 200 | 10 x 16 | 224 | 12.5 x 20 | 224 |
| 15 | 156 | 10 x 16 | 336 | 10 x 20 | 336 | 12.5 x 20 | 360 | 12.5 x 25 | 240 |
| 22 | 226 | 10 x 20 | 400 | 12.5 x 20 | 400 | 12.5 x 20 | 480 | 16 x 25 | 252 |
| 33 | 336 | 12.5 x 20 | 400 | 12.5 x 20 | 480 | 12.5 x 25 | 480 | | |
| 47 | 476 | 12.5 x 25 | 528 | 12.5 x 25 | 528 | 16 x 25 | 518 | | |
| 68 | 686 | 16 x 25 | 547 | 16 x 25 | 547 | | | | |
| 100 | 107 | 16 x 25 | 806 | | | | | | |

Maximum Allowable Ripple Current (mArms) at 130°C 100kHz

Case Size Φ D x L (mm)

| Voltage (Code) | | 400V (2G) | | 450V (2W) | |
|----------------|------|-----------|----------------|-----------|----------------|
| Cap. (µF) | Code | Case Size | Ripple Current | Case Size | Ripple Current |
| 1.5 | 155 | | | 10 x 16 | 70 |
| 1.8 | 185 | 10 x 16 | 72 | 10 x 16 | 74 |
| 2.2 | 225 | 10 x 16 | 74 | 10 x 16 | 77 |
| 2.8 | 285 | 10 x 16 | 80 | 10 x 16 | 80 |
| 3.3 | 335 | 10 x 16 | 88 | 10 x 16 | 88 |
| 4.7 | 475 | 10 x 20 | 104 | 10 x 20 | 104 |
| 5.6 | 565 | 12.5 x 20 | 112 | 12.5 x 20 | 112 |
| 6.8 | 685 | 12.5 x 20 | 176 | 12.5 x 20 | 120 |
| 8.2 | 825 | 12.5 x 20 | 208 | 12.5 x 20 | 224 |
| 10 | 106 | 12.5 x 20 | 224 | 12.5 x 20 | 256 |
| 15 | 156 | 12.5 x 25 | 256 | 12.5 x 25 | 336 |

Maximum Allowable Ripple Current (mArms) at 130°C 100kHz

Case Size Φ D x L (mm)

Specifications are subject to change without notice. Should a safety or technical concern arise regarding the product, please be sure to contact our sales offices or agents immediately.

FEATURES

- High temperature, high ripple current at high frequency, load life of 5,000–6,000 hours at 130°C.
- Specially designed for electronic ballast and energy saving lamp.



SPECIFICATIONS

| Item | Performance Characteristics | | | | | | |
|---------------------------------|---|--|--------|---|------|------|---|
| Operating Temperature Range | -25 to +130°C | | | | | | |
| Rated Working Voltage Range | 160 to 450V | | | | | | |
| Nominal Capacitance Range | 1.5 to 100µF | | | | | | |
| Capacitance Tolerance | ±20% at 120Hz, +20°C | | | | | | |
| Leakage Current | I ≤ 0.02CV + 25 (µA) after 2 minutes application of rated working voltage at +20°C | | | | | | |
| tan δ (120Hz, +20°C) | Working Voltage (V) | 160 | 200 | 250 | 350 | 400 | 450 |
| | tan δ (max.) | 0.15 | 0.15 | 0.15 | 0.20 | 0.20 | 0.20 |
| Low Temperature Characteristics | Impedance ratio max. at 120Hz | | | | | | |
| | Rated Voltage (V) Z-25°C / Z+20°C | 160 | 200 | 250 | 350 | 400 | 450 |
| High Temperature Loading | Test time | ΦD ≤ 12.5 | > 12.5 | Post test requirements at +20°C | | | |
| | Load life | 5,000h | 6,000h | Leakage current : ≤ Initial specified value Cap. change : within ±30% of the initial measured value tan δ : ≤ 200% of the initial specified value | | | |
| Shelf Life | Test temperature | +130°C | | | | | Cap. change : within ±30% of the initial measured value |
| | Test conditions | Rated DC working voltage with rated ripple current | | | | | tan δ : ≤ 200% of the initial specified value |
| Industrial Standard | At +105°C no voltage applied after 1,000 hours and then being stabilized at +20°C the capacitors shall meet the following limits | | | | | | |
| | Leakage current : ≤ Initial specified value Cap. change : within ±30% of the initial measured value tan δ : ≤ 200% of the initial specified value | | | | | | |

CASE SIZE TABLE



| ΦD | 10 | 12.5 | 16 |
|----|--------------|------|--------------|
| F | 5.0 | 5.0 | 7.5 |
| Φd | 0.6 | 0.6 | 0.8 |
| α | (L < 20) 1.5 | | (L ≥ 20) 2.0 |
| β | (D < 20) 0.5 | | (D ≥ 20) 1.0 |

RIPPLE CURRENT MULTIPLIER

Frequency Coefficient

| Coefficient | 120 | 1k | 10k | 100k |
|-------------|------|------|------|------|
| 1.5~5.6 | 0.20 | 0.40 | 0.80 | 1.00 |
| 6.8~100 | 0.40 | 0.75 | 0.90 | 1.00 |

PART NUMBER SYSTEM (EXAMPLE : 250V 10µF)

| 1 | 2 3 | 4 5 6 | 7 | 8 9 | 10 | 11 12 | 13 14 | |
|---|-----|-------|---|-----|----|-------|-------|--------------------|
| E | RC | 106 | M | 2E | G | 16 | RR | |
| | | | | | | | | Type (Radial Bulk) |
| | | | | | | | | Case Length (16mm) |
| | | | | | | | | Diameter (10mm) |
| | | | | | | | | Voltage (250V) |
| | | | | | | | | Tolerance (±20%) |
| | | | | | | | | Capacitance (10µF) |
| | | | | | | | | Series |
| | | | | | | | | E-CAP |

STANDARD RATINGS

| Voltage (Code) | | 160V (2C) | | 200V (2D) | | 250V (2E) | | 350V (2V) | |
|----------------|------|-----------|----------------|-----------|----------------|-----------|----------------|-----------|----------------|
| Cap. (µF) | Code | Case Size | Ripple Current | Case Size | Ripple Current | Case Size | Ripple Current | Case Size | Ripple Current |
| 2.2 | 225 | | | | | | | 10 x 16 | 50 |
| 3.3 | 335 | | | | | | | 10 x 16 | 58 |
| 4.7 | 475 | | | | | 10 x 16 | 56 | 10 x 20 | 70 |
| 5.6 | 565 | | | | | 10 x 16 | 60 | 12.5 x 20 | 85 |
| 6.8 | 685 | | | | | 10 x 16 | 65 | 12.5 x 20 | 120 |
| 8.2 | 825 | 10 x 16 | 65 | 10 x 16 | 70 | 10 x 16 | 70 | 12.5 x 20 | 135 |
| 10 | 106 | 10 x 16 | 140 | 10 x 16 | 140 | 10 x 16 | 155 | 12.5 x 20 | 155 |
| 15 | 156 | 10 x 16 | 235 | 10 x 20 | 235 | 12.5 x 20 | 250 | 12.5 x 25 | 168 |
| 22 | 226 | 10 x 20 | 280 | 12.5 x 20 | 280 | 12.5 x 20 | 335 | 16 x 25 | 175 |
| 33 | 336 | 12.5 x 20 | 290 | 12.5 x 20 | 335 | 12.5 x 25 | 335 | | |
| 47 | 476 | 12.5 x 25 | 365 | 12.5 x 25 | 365 | 16 x 25 | 360 | | |
| 68 | 686 | 16 x 25 | 380 | 16 x 25 | 380 | | | | |
| 100 | 107 | 16 x 25 | 565 | | | | | | |

Maximum Allowable Ripple Current (mArms) at 130°C 100kHz

Case Size Φ D x L (mm)

| Voltage (Code) | | 400V (2G) | | 450V (2W) | |
|----------------|------|-----------|----------------|-----------|----------------|
| Cap. (µF) | Code | Case Size | Ripple Current | Case Size | Ripple Current |
| 1.5 | 155 | | | 10 x 16 | 50 |
| 1.8 | 185 | 10 x 16 | 50 | 10 x 16 | 52 |
| 2.2 | 225 | 10 x 16 | 52 | 10 x 16 | 54 |
| 2.8 | 285 | 10 x 16 | 56 | 10 x 16 | 56 |
| 3.3 | 335 | 10 x 16 | 62 | 10 x 16 | 62 |
| 4.7 | 475 | 10 x 20 | 72 | 10 x 20 | 72 |
| 5.6 | 565 | 12.5 x 20 | 78 | 12.5 x 20 | 78 |
| 6.8 | 685 | 12.5 x 20 | 120 | 12.5 x 20 | 84 |
| 8.2 | 825 | 12.5 x 20 | 145 | 12.5 x 20 | 156 |
| 10 | 106 | 12.5 x 20 | 155 | 12.5 x 20 | 179 |
| 15 | 156 | 12.5 x 25 | 180 | 12.5 x 25 | 235 |

Maximum Allowable Ripple Current (mArms) at 130°C 100kHz

Case Size Φ D x L (mm)

Specifications are subject to change without notice. Should a safety or technical concern arise regarding the product, please be sure to contact our sales offices or agents immediately.

FEATURES

- Standard, for audio equipment.
- Low distortion ratio ensured with anti-vibration structures.

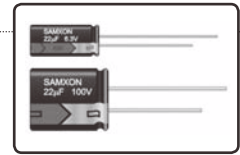

SPECIFICATIONS

| Item | Performance Characteristics | | | | | | | | | | | | | | | | | | | | | | | | | | | |
|--|---|---------------------|------|------|------|------|------|------|-----|-----|-----------------|------|------|------|------|------|------|------|------|-----------------|---|---|---|---|---|---|---|---|
| Operating Temperature Range | -40 to +85°C | | | | | | | | | | | | | | | | | | | | | | | | | | | |
| Rated Working Voltage Range | 6.3 to 100V | | | | | | | | | | | | | | | | | | | | | | | | | | | |
| Nominal Capacitance Range | 2.2 to 10000µF | | | | | | | | | | | | | | | | | | | | | | | | | | | |
| Capacitance Tolerance | ±20% at 120Hz, +20°C | | | | | | | | | | | | | | | | | | | | | | | | | | | |
| Leakage Current | I ≤ 0.01CV or 3 (µA) whichever is greater measured after 2 minutes application of rated working voltage at +20°C | | | | | | | | | | | | | | | | | | | | | | | | | | | |
| tan δ (120Hz, +20°C) | <table border="1"> <tr> <th>Working Voltage (V)</th> <td>6.3</td> <td>10</td> <td>16</td> <td>25</td> <td>35</td> <td>50</td> <td>63</td> <td>100</td> </tr> <tr> <th>tan δ (max.)</th> <td>0.22</td> <td>0.19</td> <td>0.16</td> <td>0.14</td> <td>0.12</td> <td>0.10</td> <td>0.09</td> <td>0.08</td> </tr> </table> | Working Voltage (V) | 6.3 | 10 | 16 | 25 | 35 | 50 | 63 | 100 | tan δ (max.) | 0.22 | 0.19 | 0.16 | 0.14 | 0.12 | 0.10 | 0.09 | 0.08 | | | | | | | | | |
| | Working Voltage (V) | 6.3 | 10 | 16 | 25 | 35 | 50 | 63 | 100 | | | | | | | | | | | | | | | | | | | |
| tan δ (max.) | 0.22 | 0.19 | 0.16 | 0.14 | 0.12 | 0.10 | 0.09 | 0.08 | | | | | | | | | | | | | | | | | | | | |
| For capacitance value >1000µF, add 0.02 per another 1000µF | | | | | | | | | | | | | | | | | | | | | | | | | | | | |
| Low Temperature Characteristics | Impedance ratio max. at 120Hz | | | | | | | | | | | | | | | | | | | | | | | | | | | |
| | <table border="1"> <tr> <th>Working Voltage (V)</th> <td>6.3</td> <td>10</td> <td>16</td> <td>25</td> <td>35</td> <td>50</td> <td>63</td> <td>100</td> </tr> <tr> <th>Z-25°C / Z+20°C</th> <td>4</td> <td>3</td> <td>2</td> <td>2</td> <td>2</td> <td>2</td> <td>2</td> <td>2</td> </tr> <tr> <th>Z-40°C / Z+20°C</th> <td>8</td> <td>6</td> <td>4</td> <td>4</td> <td>3</td> <td>3</td> <td>3</td> <td>3</td> </tr> </table> | Working Voltage (V) | 6.3 | 10 | 16 | 25 | 35 | 50 | 63 | 100 | Z-25°C / Z+20°C | 4 | 3 | 2 | 2 | 2 | 2 | 2 | 2 | Z-40°C / Z+20°C | 8 | 6 | 4 | 4 | 3 | 3 | 3 | 3 |
| | Working Voltage (V) | 6.3 | 10 | 16 | 25 | 35 | 50 | 63 | 100 | | | | | | | | | | | | | | | | | | | |
| Z-25°C / Z+20°C | 4 | 3 | 2 | 2 | 2 | 2 | 2 | 2 | | | | | | | | | | | | | | | | | | | | |
| Z-40°C / Z+20°C | 8 | 6 | 4 | 4 | 3 | 3 | 3 | 3 | | | | | | | | | | | | | | | | | | | | |
| | | | | | | | | | | | | | | | | | | | | | | | | | | | | |
| High Temperature Loading | Test time : 1,000 hours Test temperature : +85°C Test conditions : Rated DC working voltage with rated ripple current | | | | | | | | | | | | | | | | | | | | | | | | | | | |
| | Post test requirements at +20°C Leakage current : ≤ Initial specified value Cap. change : within ±20% of the initial measured value tan δ : ≤ 150% of the initial specified value | | | | | | | | | | | | | | | | | | | | | | | | | | | |
| Shelf Life | At +85°C no voltage applied after 1,000 hours and then being stabilized at +20°C the capacitors shall meet the following limits Leakage current : ≤ Initial specified value Cap. change : within ±20% of the initial measured value tan δ : ≤ 150% of the initial specified value | | | | | | | | | | | | | | | | | | | | | | | | | | | |
| Industrial Standard | JIS C - 5101-4 (IEC 60384-4) | | | | | | | | | | | | | | | | | | | | | | | | | | | |

CASE SIZE TABLE

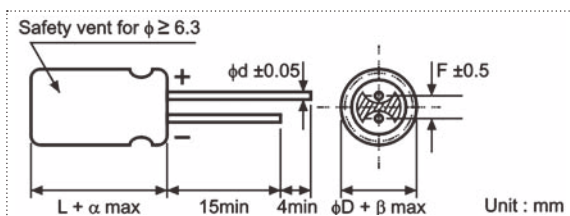

| φD | 5 | 6.3 | 8 (L < 20) | 8 (L ≥ 20) | 10 | 12.5 | 16 | 18 |
|----|-----|-----|------------|--------------|--------------|------|-----|-----|
| F | 2.0 | 2.5 | 3.5 | 3.5 | 5.0 | 5.0 | 7.5 | 7.5 |
| φd | 0.5 | 0.5 | 0.5 | 0.6 | 0.6 | 0.6 | 0.8 | 0.8 |
| α | | | | (L < 20) 1.5 | (L ≥ 20) 2.0 | | | |
| β | | | | (D < 20) 0.5 | (D ≥ 20) 1.0 | | | |

RIPPLE CURRENT MULTIPLIER

Frequency Coefficient

| Coefficient | Cap (µF) | 50 | 120 | 300 | 1k | 10k~ |
|-------------|----------|------|------|------|------|------|
| ≤ 47 | | 0.75 | 1.00 | 1.35 | 1.57 | 2.00 |
| 68-470 | | 0.80 | 1.00 | 1.23 | 1.34 | 1.50 |
| ≥ 560 | | 0.85 | 1.00 | 1.10 | 1.13 | 1.15 |

PART NUMBER SYSTEM (EXAMPLE : 25V 220µF)

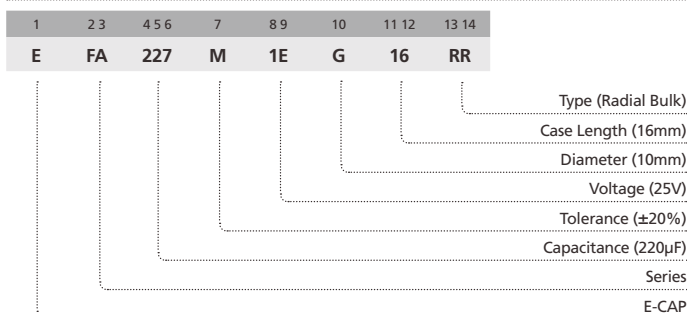

STANDARD RATINGS

| Voltage (Code) | | 6.3V (0J) | | 10V (1A) | | 16V (1C) | | 25V (1E) | |
|----------------|------|-----------|----------------|-----------|----------------|-----------|----------------|-----------|----------------|
| Cap. (μF) | Code | Case Size | Ripple Current | Case Size | Ripple Current | Case Size | Ripple Current | Case Size | Ripple Current |
| 4.7 | 475 | | | | | | | 5 x 11 | 22 |
| 10 | 106 | | | | | 5 x 11 | 31 | 5 x 11 | 32 |
| 22 | 226 | 5 x 11 | 36 | 5 x 11 | 41 | 5 x 11 | 46 | 5 x 11 | 50 |
| 33 | 336 | 5 x 11 | 46 | 5 x 11 | 51 | 5 x 11 | 57 | 6.3 x 11 | 70 |
| 47 | 476 | 5 x 11 | 55 | 5 x 11 | 60 | 6.3 x 11 | 74 | 6.3 x 11 | 85 |
| 100 | 107 | 6.3 x 11 | 88 | 6.3 x 11 | 99 | 8 x 12 | 128 | 8 x 12 | 140 |
| 220 | 227 | 8 x 12 | 155 | 8 x 12 | 170 | 10 x 12.5 | 226 | 10 x 16 | 260 |
| 330 | 337 | 10 x 12.5 | 226 | 10 x 12.5 | 247 | 10 x 16 | 309 | 10 x 20 | 351 |
| 470 | 477 | 10 x 12.5 | 270 | 10 x 16 | 330 | 10 x 20 | 406 | 12.5 x 20 | 476 |
| 1000 | 108 | 10 x 20 | 485 | 12.5 x 20 | 601 | 12.5 x 25 | 723 | 16 x 25 | 854 |
| 2200 | 228 | 12.5 x 25 | 867 | 16 x 25 | 1047 | 16 x 25 | 1209 | 16 x 35 | 1570 |
| 3300 | 338 | 16 x 25 | 1135 | 16 x 30 | 1520 | 16 x 25 | 1720 | 18 x 40 | 1794 |
| 4700 | 478 | 16 x 30 | 1431 | 16 x 35 | 1840 | 18 x 35 | 2140 | | |
| 6800 | 688 | 18 x 35 | 1810 | 18 x 40 | 2049 | | | | |
| 10000 | 109 | 18 x 40 | 2100 | | | | | | |

Maximum Allowable Ripple Current (mArms) at 85°C 120Hz

Case Size ΦD x L (mm)

| Voltage (Code) | | 35V (1V) | | 50V (1H) | | 63V (1J) | | 100V (2A) | |
|----------------|------|-----------|----------------|-----------|----------------|-----------|----------------|-----------|----------------|
| Cap. (μF) | Code | Case Size | Ripple Current | Case Size | Ripple Current | Case Size | Ripple Current | Case Size | Ripple Current |
| 2.2 | 225 | | | 5 x 11 | 18 | | | 5 x 11 | 22 |
| 3.3 | 335 | | | 5 x 11 | 22 | | | 5 x 11 | 27 |
| 4.7 | 475 | 5 x 11 | 24 | 5 x 11 | 27 | | | 5 x 11 | 36 |
| 10 | 106 | 5 x 11 | 36 | 5 x 11 | 39 | 6.3 x 11 | 50 | 8 x 12 | 65 |
| 22 | 226 | 6.3 x 11 | 60 | 6.3 x 11 | 65 | 8 x 12 | 85 | 10 x 12.5 | 110 |
| 33 | 336 | 6.3 x 11 | 75 | 8 x 12 | 93 | 8 x 12 | 105 | 10 x 16 | 150 |
| 47 | 476 | 8 x 12 | 101 | 8 x 12 | 111 | 10 x 12.5 | 140 | 10 x 20 | 190 |
| 100 | 107 | 10 x 12.5 | 176 | 10 x 16 | 215 | 10 x 20 | 255 | 12.5 x 20 | 300 |
| 220 | 227 | 10 x 20 | 320 | 12.5 x 20 | 390 | 12.5 x 20 | 420 | 16 x 25 | 549 |
| 330 | 337 | 12.5 x 20 | 446 | 12.5 x 20 | 488 | 12.5 x 25 | 541 | 16 x 30 | 734 |
| 470 | 477 | 12.5 x 25 | 590 | 16 x 25 | 650 | 16 x 25 | 840 | 18 x 35 | 980 |
| 1000 | 108 | 16 x 25 | 1060 | 16 x 30 | 1143 | 18 x 35 | 1400 | | |
| 2200 | 228 | 18 x 35 | 1840 | | | | | | |

Maximum Allowable Ripple Current (mArms) at 85°C 120Hz

Case Size ΦD x L (mm)

Specifications are subject to change without notice. Should a safety or technical concern arise regarding the product, please be sure to contact our sales offices or agents immediately.

FEATURES

➤ Standard non-polarized series for entertainment electronics.

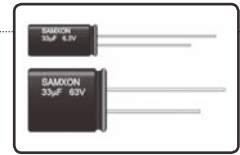

SPECIFICATIONS

| Item | Performance Characteristics | | | | | | | | | | | | | | | | | | | | | | | | | | | |
|--|--|---------------------|------|------|------|------|------|------|-----|-----|-----------------|------|------|------|------|------|------|------|------|-----------------|----|---|---|---|---|---|---|---|
| Operating Temperature Range | -40 to +85°C | | | | | | | | | | | | | | | | | | | | | | | | | | | |
| Rated Working Voltage Range | 6.3 to 100V | | | | | | | | | | | | | | | | | | | | | | | | | | | |
| Nominal Capacitance Range | 2.2 to 6800µF | | | | | | | | | | | | | | | | | | | | | | | | | | | |
| Capacitance Tolerance | ±20% at 120Hz, +20°C | | | | | | | | | | | | | | | | | | | | | | | | | | | |
| Leakage Current | I ≤ 0.03CV or 3 (µA) whichever is greater measured after 5 minutes application of rated working voltage at +20°C | | | | | | | | | | | | | | | | | | | | | | | | | | | |
| tan δ (120Hz, +20°C) | <table border="1"> <tr> <th>Working Voltage (V)</th> <td>6.3</td> <td>10</td> <td>16</td> <td>25</td> <td>35</td> <td>50</td> <td>63</td> <td>100</td> </tr> <tr> <th>Tan δ (max.)</th> <td>0.26</td> <td>0.24</td> <td>0.22</td> <td>0.20</td> <td>0.16</td> <td>0.14</td> <td>0.12</td> <td>0.10</td> </tr> </table> | Working Voltage (V) | 6.3 | 10 | 16 | 25 | 35 | 50 | 63 | 100 | Tan δ (max.) | 0.26 | 0.24 | 0.22 | 0.20 | 0.16 | 0.14 | 0.12 | 0.10 | | | | | | | | | |
| | Working Voltage (V) | 6.3 | 10 | 16 | 25 | 35 | 50 | 63 | 100 | | | | | | | | | | | | | | | | | | | |
| Tan δ (max.) | 0.26 | 0.24 | 0.22 | 0.20 | 0.16 | 0.14 | 0.12 | 0.10 | | | | | | | | | | | | | | | | | | | | |
| For capacitance value >1000µF, add 0.02 per another 1000µF | | | | | | | | | | | | | | | | | | | | | | | | | | | | |
| Low Temperature Characteristics | Impedance ratio max. at 120Hz | | | | | | | | | | | | | | | | | | | | | | | | | | | |
| | <table border="1"> <tr> <th>Working Voltage (V)</th> <td>6.3</td> <td>10</td> <td>16</td> <td>25</td> <td>35</td> <td>50</td> <td>63</td> <td>100</td> </tr> <tr> <th>Z-25°C / Z+20°C</th> <td>4</td> <td>3</td> <td>2</td> <td>2</td> <td>2</td> <td>2</td> <td>2</td> <td>2</td> </tr> <tr> <th>Z-40°C / Z+20°C</th> <td>10</td> <td>8</td> <td>6</td> <td>5</td> <td>4</td> <td>4</td> <td>3</td> <td>3</td> </tr> </table> | Working Voltage (V) | 6.3 | 10 | 16 | 25 | 35 | 50 | 63 | 100 | Z-25°C / Z+20°C | 4 | 3 | 2 | 2 | 2 | 2 | 2 | 2 | Z-40°C / Z+20°C | 10 | 8 | 6 | 5 | 4 | 4 | 3 | 3 |
| | Working Voltage (V) | 6.3 | 10 | 16 | 25 | 35 | 50 | 63 | 100 | | | | | | | | | | | | | | | | | | | |
| Z-25°C / Z+20°C | 4 | 3 | 2 | 2 | 2 | 2 | 2 | 2 | | | | | | | | | | | | | | | | | | | | |
| Z-40°C / Z+20°C | 10 | 8 | 6 | 5 | 4 | 4 | 3 | 3 | | | | | | | | | | | | | | | | | | | | |
| | | | | | | | | | | | | | | | | | | | | | | | | | | | | |
| High Temperature Loading | Test time : 1,000 hours Test temperature : +85°C Test conditions : Rated DC working voltage to each polarity every 250 hours | | | | | | | | | | | | | | | | | | | | | | | | | | | |
| | Post test requirements at +20°C Leakage current : ≤ Initial specified value Cap. change : within ±20% of the initial measured value tan δ : ≤ 200% of the initial specified value | | | | | | | | | | | | | | | | | | | | | | | | | | | |
| Shelf Life | At +85°C no voltage applied after 1,000 hours and then being stabilized at +20°C the capacitors shall meet the following limits Leakage current : ≤ Initial specified value Cap. change : within ±20% of the initial measured value tan δ : ≤ 200% of the initial specified value | | | | | | | | | | | | | | | | | | | | | | | | | | | |
| Industrial Standard | JIS C - 5101-4 (IEC 60384-4) | | | | | | | | | | | | | | | | | | | | | | | | | | | |

CASE SIZE TABLE



| | | | | | | | | |
|----|-----|-----|------------|------------|-----|------|--------------|--------------|
| φD | 5 | 6.3 | 8 (L < 20) | 8 (L ≥ 20) | 10 | 12.5 | 16 | 18 |
| F | 2.0 | 2.5 | 3.5 | 3.5 | 5.0 | 5.0 | 7.5 | 7.5 |
| φd | 0.5 | 0.5 | 0.5 | 0.6 | 0.6 | 0.6 | 0.8 | 0.8 |
| α | | | | | | | (L < 20) 1.5 | (L ≥ 20) 2.0 |
| β | | | | | | | (D < 20) 0.5 | (D ≥ 20) 1.0 |

RIPPLE CURRENT MULTIPLIER

Frequency Coefficient

| Coefficient | Cap (µF) | 50 | 120 | 300 | 1k | 10k~ |
|-------------|----------|------|------|------|------|------|
| ≤47 | | 0.75 | 1.00 | 1.35 | 1.57 | 2.00 |
| 68~470 | | 0.80 | 1.00 | 1.23 | 1.34 | 1.50 |
| ≥560 | | 0.85 | 1.00 | 1.10 | 1.13 | 1.15 |

PART NUMBER SYSTEM (EXAMPLE : 16V 100µF)



NP

Miniature Aluminum Electrolytic Capacitors

STANDARD RATINGS

| Voltage (Code) | | 6.3V (0J) | | 10V (1A) | | 16V (1C) | | 25V (1E) | |
|----------------|------|-----------|----------------|-----------|----------------|-----------|----------------|-----------|----------------|
| Cap. (µF) | Code | Case Size | Ripple Current | Case Size | Ripple Current | Case Size | Ripple Current | Case Size | Ripple Current |
| 4.7 | 475 | | | | | | | 5 x 11 | 26 |
| 10 | 106 | | | | | 5 x 11 | 42 | 5 x 11 | 42 |
| 22 | 226 | | | 5 x 11 | 57 | 5 x 11 | 57 | 6.3 x 11 | 65 |
| 33 | 336 | 5 x 11 | 64 | 5 x 11 | 64 | 5 x 11 | 70 | 6.3 x 11 | 80 |
| 47 | 476 | 5 x 11 | 76 | 5 x 11 | 76 | 6.3 x 11 | 95 | 6.3 x 11 | 95 |
| 100 | 107 | 6.3 x 11 | 125 | 6.3 x 11 | 125 | 8 x 12 | 160 | 8 x 12 | 160 |
| 220 | 227 | 8 x 12 | 215 | 8 x 12 | 215 | 10 x 12.5 | 275 | 10 x 16 | 305 |
| 330 | 337 | 8 x 12 | 265 | 10 x 16 | 345 | 10 x 16 | 375 | 12.5 x 20 | 450 |
| 470 | 477 | 10 x 12.5 | 370 | 10 x 16 | 410 | 10 x 20 | 485 | 12.5 x 20 | 540 |
| 1000 | 108 | 10 x 20 | 650 | 12.5 x 20 | 720 | 12.5 x 25 | 855 | 16 x 25 | 950 |
| 2200 | 228 | 12.5 x 25 | 1160 | 16 x 25 | 1280 | 16 x 30 | 1510 | 18 x 35 | 1620 |
| 3300 | 338 | 16 x 25 | 1570 | 16 x 30 | 1690 | 18 x 35 | 1980 | | |
| 4700 | 478 | 16 x 30 | 2020 | 18 x 35 | 2160 | | | | |
| 6800 | 688 | 18 x 35 | 2600 | | | | | | |

Maximum Allowable Ripple Current (mArms) at 85°C 120Hz

Case Size Φ D x L (mm)

| Voltage (Code) | | 35V (1V) | | 50V (1H) | | 63V (1J) | | 100V (2A) | |
|----------------|------|-----------|----------------|-----------|----------------|-----------|----------------|-----------|----------------|
| Cap. (µF) | Code | Case Size | Ripple Current | Case Size | Ripple Current | Case Size | Ripple Current | Case Size | Ripple Current |
| 2.2 | 225 | | | 5 x 11 | 25 | | | 6.3 x 11 | 34 |
| 3.3 | 335 | | | 5 x 11 | 27 | 5 x 11 | 28 | 6.3 x 11 | 39 |
| 4.7 | 475 | 5 x 11 | 34 | 5 x 11 | 34 | 6.3 x 11 | 34 | 6.3 x 11 | 47 |
| 10 | 106 | 5 x 11 | 43 | 6.3 x 11 | 52 | 6.3 x 11 | 57 | 8 x 12 | 71 |
| 22 | 226 | 6.3 x 11 | 73 | 8 x 12 | 89 | 8 x 12 | 95 | 10 x 16 | 135 |
| 33 | 336 | 8 x 12 | 100 | 8 x 12 | 105 | 10 x 12.5 | 135 | 12.5 x 20 | 220 |
| 47 | 476 | 8 x 12 | 120 | 10 x 12.5 | 150 | 10 x 16 | 180 | 12.5 x 20 | 240 |
| 68 | 686 | | | 10 x 16 | 198 | | | | |
| 100 | 107 | 10 x 16 | 230 | 10 x 20 | 265 | 12.5 x 20 | 320 | 16 x 25 | 425 |
| 220 | 227 | 12.5 x 20 | 410 | 12.5 x 25 | 480 | 16 x 25 | 575 | 18 x 35 | 720 |
| 330 | 337 | 12.5 x 20 | 505 | 16 x 25 | 650 | 16 x 30 | 655 | | |
| 470 | 477 | 12.5 x 25 | 655 | 16 x 30 | 835 | 18 x 35 | 965 | | |
| 1000 | 108 | 16 x 30 | 1140 | | | | | | |

Maximum Allowable Ripple Current (mArms) at 85°C 120Hz

Case Size Φ D x L (mm)

Specifications are subject to change without notice. Should a safety or technical concern arise regarding the product, please be sure to contact our sales offices or agents immediately.

FEATURES

- Nonpolar, high temperature.
- Suitable for use in polarity and change circuits.

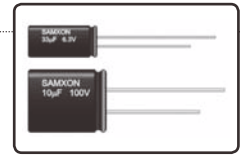

SPECIFICATIONS

| Item | Performance Characteristics | | | | | | | | |
|---------------------------------|---|---|------|------|--|------|------|------|------|
| Operating Temperature Range | -40 to +105°C | | | | | | | | |
| Rated Working Voltage Range | 6.3 to 100V | | | | | | | | |
| Nominal Capacitance Range | 2.2 to 1000µF | | | | | | | | |
| Capacitance Tolerance | ±20% at 120Hz, +20°C | | | | | | | | |
| Leakage Current | I ≤ 0.03CV or 3 (µA) whichever is greater measured after 5 minutes application of rated working voltage at +20°C | | | | | | | | |
| tan δ (120Hz, +20°C) | Working Voltage (V) | 6.3 | 10 | 16 | 25 | 35 | 50 | 63 | 100 |
| | tan δ (max.) | 0.26 | 0.24 | 0.22 | 0.20 | 0.16 | 0.14 | 0.12 | 0.10 |
| Low Temperature Characteristics | Impedance ratio max. at 120Hz | | | | | | | | |
| | Working Voltage (V) | 6.3 | 10 | 16 | 25 | 35 | 50 | 63 | 100 |
| | Z-25°C / Z+20°C | 4 | 3 | 2 | 2 | 2 | 2 | 2 | 2 |
| High Temperature Loading | Test time | : 1,000 hours | | | Post test requirements at +20°C | | | | |
| | Test temperature | : +105°C | | | Leakage current : ≤ Initial specified value | | | | |
| | Test conditions | : Rated DC working voltage to each polarity every 250 hours | | | Cap. change : within ±20% of the initial measured value tan δ : ≤ 200% of the initial specified value | | | | |
| Shelf Life | At +105°C no voltage applied after 1,000 hours and then being stabilized at +20°C the capacitors shall meet the following limits Leakage current : ≤ Initial specified value Cap. change : within ±20% of the initial measured value tan δ : ≤ 200% of the initial specified value | | | | | | | | |
| Industrial Standard | JIS C - 5101-4 (IEC 60384-4) | | | | | | | | |

CASE SIZE TABLE

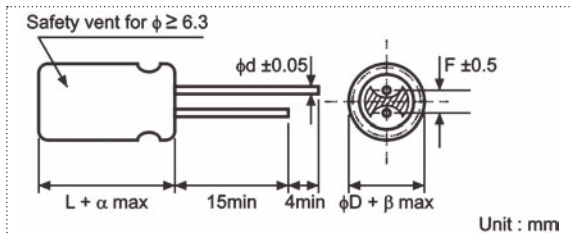

| | | | | | | | |
|----|--------------|-----|------------|--------------|-----|------|-----|
| φD | 5 | 6.3 | 8 (L < 20) | 8 (L ≥ 20) | 10 | 12.5 | 16 |
| F | 2.0 | 2.5 | 3.5 | 3.5 | 5.0 | 5.0 | 7.5 |
| φd | 0.5 | 0.5 | 0.5 | 0.6 | 0.6 | 0.6 | 0.8 |
| α | (L < 20) 1.5 | | | (L ≥ 20) 2.0 | | | |
| β | (D < 20) 0.5 | | | (D ≥ 20) 1.0 | | | |

RIPPLE CURRENT MULTIPLIER

Frequency Coefficient

| Coefficient | Freq. (Hz) | 50 | 120 | 300 | 1k | 10k~ |
|-------------|------------|------|------|------|------|------|
| Cap (µF) | ≤ 47 | 0.75 | 1.00 | 1.35 | 1.57 | 2.00 |
| | 68-220 | 0.80 | 1.00 | 1.23 | 1.34 | 1.50 |
| | ≥ 560 | 0.85 | 1.00 | 1.10 | 1.13 | 1.15 |

PART NUMBER SYSTEM (EXAMPLE : 10V 47µF)



STANDARD RATINGS

| Voltage (Code) | | 6.3V (0J) | | 10V (1A) | | 16V (1C) | | 25V (1E) | |
|----------------|------|-----------|----------------|-----------|----------------|-----------|----------------|-----------|----------------|
| Cap. (µF) | Code | Case Size | Ripple Current | Case Size | Ripple Current | Case Size | Ripple Current | Case Size | Ripple Current |
| 4.7 | 475 | | | | | | | 5 x 11 | 23 |
| 10 | 106 | | | | | 5 x 11 | 30 | 5 x 11 | 34 |
| 22 | 226 | | | 5 x 11 | 42 | 6.3 x 11 | 51 | 6.3 x 11 | 55 |
| 33 | 336 | 5 x 11 | 46 | 6.3 x 11 | 57 | 6.3 x 11 | 63 | 8 x 12 | 79 |
| 47 | 476 | 6.3 x 11 | 61 | 6.3 x 11 | 67 | 8 x 12 | 89 | 10 x 12.5 | 100 |
| 100 | 107 | 8 x 12 | 104 | 10 x 12.5 | 125 | 10 x 12.5 | 139 | 10 x 16 | 164 |
| 220 | 227 | 10 x 12.5 | 168 | 10 x 16 | 204 | 10 x 20 | 279 | 12.5 x 25 | 336 |
| 330 | 337 | 10 x 16 | 229 | 10 x 20 | 275 | 12.5 x 20 | 346 | 12.5 x 25 | 414 |
| 470 | 477 | 10 x 20 | 330 | 12.5 x 20 | 371 | 12.5 x 25 | 460 | 16 x 25 | 543 |
| 1000 | 108 | 12.5 x 25 | 550 | 16 x 25 | 668 | 16 x 25 | 746 | 16 x 30 | 871 |

Maximum Allowable Ripple Current (mArms) at 105°C 120Hz

Case Size Φ D x L (mm)

| Voltage (Code) | | 35V (1V) | | 50V (1H) | | 63V (1J) | | 100V (2A) | |
|----------------|------|-----------|----------------|-----------|----------------|-----------|----------------|-----------|----------------|
| Cap. (µF) | Code | Case Size | Ripple Current | Case Size | Ripple Current | Case Size | Ripple Current | Case Size | Ripple Current |
| 2.2 | 225 | | | 5 x 11 | 18 | | | 6.3 x 11 | 22 |
| 3.3 | 335 | | | 5 x 11 | 22 | 6.3 x 11 | 26 | 8 x 12 | 32 |
| 4.7 | 475 | 5 x 11 | 25 | 6.3 x 11 | 29 | 6.3 x 11 | 31 | 8 x 12 | 39 |
| 10 | 106 | 6.3 x 11 | 40 | 8 x 12 | 51 | 8 x 12 | 53 | 10 x 12.5 | 64 |
| 22 | 226 | 8 x 12 | 68 | 10 x 12.5 | 82 | 10 x 16 | 96 | 10 x 20 | 114 |
| 33 | 336 | 10 x 12.5 | 89 | 10 x 16 | 107 | 10 x 20 | 129 | 12.5 x 20 | 164 |
| 47 | 476 | 10 x 12.5 | 111 | 10 x 20 | 146 | 10 x 20 | 157 | 12.5 x 25 | 200 |
| 100 | 107 | 10 x 20 | 196 | 12.5 x 25 | 264 | 12.5 x 25 | 275 | 16 x 25 | 304 |
| 220 | 227 | 12.5 x 25 | 364 | 16 x 25 | 443 | 16 x 30 | 486 | | |
| 330 | 337 | 16 x 25 | 493 | 16 x 30 | 593 | | | | |
| 470 | 477 | 16 x 25 | 586 | | | | | | |

Maximum Allowable Ripple Current (mArms) at 105°C 120Hz

Case Size Φ D x L (mm)

Specifications are subject to change without notice. Should a safety or technical concern arise regarding the product, please be sure to contact our sales offices or agents immediately.

FEATURES

- 105°C high temperature and high voltage, load life : 2,000 hours.
- For slim size adaptor, LCD / LED-TV and LCD-Monitor power.



SPECIFICATIONS

| Item | Performance Characteristics | | | | | | | |
|---------------------------------|--|---|------|------|------|------|---|--|
| Operating Temperature Range | -25 to +105°C | | | | | | | |
| Rated Working Voltage Range | 200 to 450V | | | | | | | |
| Nominal Capacitance Range | 22 to 270μF | | | | | | | |
| Capacitance Tolerance | ±20% at 120Hz, +20°C | | | | | | | |
| Leakage Current | I ≤ 0.03CV + 40 (μA) after 2 minutes application of rated working voltage at +20°C | | | | | | | |
| tan δ (120Hz, +20°C) | Working Voltage (V) | 200 | 220 | 250 | 400 | 420 | 450 | |
| | tan δ (max.) | 0.20 | 0.20 | 0.20 | 0.24 | 0.24 | 0.24 | |
| Low Temperature Characteristics | Impedance ratio max. at 120Hz | | | | | | | |
| | Rated Voltage (V) Z-25°C / Z+20°C | 200 | 220 | 250 | 400 | 420 | 450 | |
| High Temperature Loading | Test time | : 2,000 hours | | | | | Post test requirements at +20°C | |
| | Test temperature | : +105°C | | | | | Leakage current : ≤ Initial specified value | |
| | Test conditions | : Rated DC working voltage with rated ripple current | | | | | Cap. change : within ±20% of the initial measured value | |
| | | | | | | | tan δ : ≤ 200% of the initial specified value | |
| Shelf Life | At +105°C no voltage applied after 1,000 hours and then being stabilized at +20°C the capacitors shall meet the following limits | | | | | | | |
| | Leakage current | : ≤ Initial specified value | | | | | | |
| | Cap. change | : within ±20% of the initial measured value | | | | | | |
| | tan δ | : ≤ 200% of the initial specified value | | | | | | |
| Industrial Standard | JIS C - 5101-4 (IEC 60384-4) | | | | | | | |

CASE SIZE TABLE



| | | |
|----|-----|------|
| φD | 10 | 12.5 |
| F | 5.0 | 5.0 |
| φd | 0.6 | 0.6 |
| α | 2.0 | |
| β | 1.0 | |

RIPPLE CURRENT MULTIPLIER

Frequency Coefficient

| Coefficient | Freq. (Hz) | 50 | 120 | 300 | 1k | 10k~ |
|---------------|------------|------|------|------|------|------|
| Rated Voltage | 200-450V | 0.80 | 1.00 | 1.25 | 1.40 | 1.60 |

PART NUMBER SYSTEM (EXAMPLE : 200V 220μF)



KM

Miniature Aluminum Electrolytic Capacitors

STANDARD RATINGS

| Voltage (Code) | | 200V (2D) | | 220V (2N) | | 250V (2E) | |
|----------------|------|-----------|----------------|-----------|----------------|-----------|----------------|
| Cap. (μF) | Code | Case Size | Ripple Current | Case Size | Ripple Current | Case Size | Ripple Current |
| 82 | 826 | | | | | 10 x 45 | 390 |
| 100 | 107 | 10 x 40 | 410 | 10 x 45 | 420 | 10 x 50 | 430 |
| | | | | | | 12.5 x 35 | 440 |
| 120 | 127 | 10 x 45 | 425 | 10 x 50 | 480 | 12.5 x 40 | 505 |
| | | 10 x 55 | 500 | | | | |
| 150 | 157 | 12.5 x 35 | 495 | 12.5 x 40 | 550 | 12.5 x 45 | 585 |
| 180 | 187 | 12.5 x 40 | 560 | 12.5 x 45 | 630 | 12.5 x 55 | 625 |
| 220 | 227 | 12.5 x 50 | 640 | 12.5 x 55 | 690 | | |
| 270 | 277 | 12.5 x 60 | 695 | | | | |

Maximum Allowable Ripple Current (mArms) at 105°C 120Hz

Case Size ΦD x L (mm)

| Voltage (Code) | | 400V (2G) | | 420V (2M) | | 450V (2W) | |
|----------------|------|-----------|----------------|-----------|----------------|-----------|----------------|
| Cap. (μF) | Code | Case Size | Ripple Current | Case Size | Ripple Current | Case Size | Ripple Current |
| 22 | 226 | | | | | 10 x 35 | 135 |
| 27 | 276 | | | | | 10 x 40 | 165 |
| 33 | 336 | 10 x 40 | 245 | 10 x 40 | 215 | 10 x 45 | 200 |
| 39 | 396 | 10 x 45 | 320 | 10 x 45 | 245 | 10 x 50 | 245 |
| | | | | | | 12.5 x 35 | 255 |
| 47 | 476 | 10 x 50 | 360 | 10 x 55 | 295 | 10 x 60 | 300 |
| | | 12.5 x 35 | 350 | 12.5 x 35 | 285 | 12.5 x 40 | 305 |
| | | 10 x 60 | 415 | | | | |
| 56 | 566 | 12.5 x 40 | 400 | 12.5 x 40 | 345 | 12.5 x 45 | 350 |
| 68 | 686 | 12.5 x 45 | 465 | 12.5 x 50 | 400 | 12.5 x 50 | 390 |
| 82 | 826 | 12.5 x 55 | 500 | 12.5 x 55 | 455 | 12.5 x 60 | 440 |
| 100 | 107 | 12.5 x 60 | 520 | | | | |

Maximum Allowable Ripple Current (mArms) at 105°C 120Hz

Case Size ΦD x L (mm)

Specifications are subject to change without notice. Should a safety or technical concern arise regarding the product, please be sure to contact our sales offices or agents immediately.

FEATURES

- 105°C high temperature and high voltage, load life : 5,000 hours.
- For slim size adaptor, LCD / LED-TV and LCD-Monitor power.

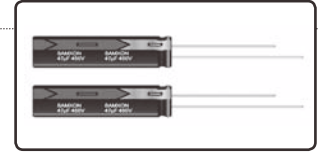

SPECIFICATIONS

| Item | Performance Characteristics | | | | | | | |
|---------------------------------|--|---|------|------|------|------|---|--|
| Operating Temperature Range | -25 to +105°C | | | | | | | |
| Rated Working Voltage Range | 200 to 450V | | | | | | | |
| Nominal Capacitance Range | 22 to 220μF | | | | | | | |
| Capacitance Tolerance | ±20% at 120Hz, +20°C | | | | | | | |
| Leakage Current | I ≤ 0.02CV + 25 (μA) after 2 minutes application of rated working voltage at +20°C | | | | | | | |
| tan δ (120Hz, +20°C) | Working Voltage (V) | 200 | 220 | 250 | 400 | 420 | 450 | |
| | tan δ (max.) | 0.20 | 0.20 | 0.20 | 0.24 | 0.24 | 0.24 | |
| Low Temperature Characteristics | Impedance ratio max. at 120Hz | | | | | | | |
| | Rated Voltage (V) Z-25°C / Z+20°C | 200 | 220 | 250 | 400 | 420 | 450 | |
| High Temperature Loading | Test time | : 5,000 hours | | | | | Post test requirements at +20°C | |
| | Test temperature | : +105°C | | | | | Leakage current : ≤ Initial specified value | |
| Shelf Life | Test conditions | : Rated DC working voltage with rated ripple current | | | | | Cap. change : within ±20% of the initial measured value | |
| | | | | | | | tan δ : ≤ 200% of the initial specified value | |
| Industrial Standard | At +105°C no voltage applied after 1,000 hours and then being stabilized at +20°C the capacitors shall meet the following limits | | | | | | | |
| | Leakage current | : ≤ Initial specified value | | | | | | |
| | Cap. change | : within ±20% of the initial measured value | | | | | | |
| | tan δ | : ≤ 200% of the initial specified value | | | | | | |
| | JIS C - 5101-4 (IEC 60384-4) | | | | | | | |

CASE SIZE TABLE

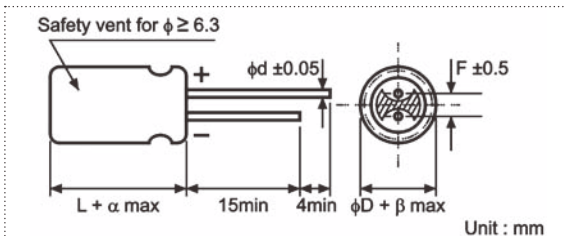

| | | |
|----|-----|------|
| φD | 10 | 12.5 |
| F | 5.0 | 5.0 |
| φd | 0.6 | 0.6 |
| α | 2.0 | |
| β | 1.0 | |

RIPPLE CURRENT MULTIPLIER

Frequency Coefficient

| Coefficient | Freq. (Hz) | | | | | |
|---------------|------------|------|------|------|------|--|
| Rated Voltage | 50 | 120 | 300 | 1k | 10k~ | |
| 200~450V | 0.80 | 1.00 | 1.25 | 1.40 | 1.60 | |

PART NUMBER SYSTEM (EXAMPLE : 250V 150μF)

| | | | | | | | |
|---|----|-----|---|----|----|-------|-------|
| 1 | 23 | 456 | 7 | 89 | 10 | 11 12 | 13 14 |
| E | RW | 157 | M | 2E | I | 50 | RR |



STANDARD RATINGS

| Voltage (Code) | | 200V (2D) | | 220V (2N) | | 250V (2E) | |
|----------------|------|----------------------|----------------|-----------|----------------|----------------------|----------------|
| Cap. (μF) | Code | Case Size | Ripple Current | Case Size | Ripple Current | Case Size | Ripple Current |
| 82 | 826 | | | | | 10 x 45 | 390 |
| 100 | 107 | 10 x 45 | 420 | 10 x 45 | 420 | 10 x 55 12.5 x 35 | 440 |
| 120 | 127 | 10 x 50 | 435 | 10 x 55 | 490 | 12.5 x 40 | 505 |
| 150 | 157 | 10 x 60 12.5 x 40 | 500 | 12.5 x 40 | 550 | 12.5 x 50 | 590 |
| 180 | 187 | 12.5 x 45 | 580 | 12.5 x 45 | 630 | 12.5 x 55 | 625 |
| 220 | 227 | 12.5 x 55 | 650 | 12.5 x 55 | 690 | | |

Maximum Allowable Ripple Current (mArms) at 105°C 120Hz

Case Size ΦD x L (mm)

| Voltage (Code) | | 400V (2G) | | 420V (2M) | | 450V (2W) | |
|----------------|------|----------------------|----------------|----------------------|----------------|----------------------|----------------|
| Cap. (μF) | Code | Case Size | Ripple Current | Case Size | Ripple Current | Case Size | Ripple Current |
| 22 | 226 | | | | | 10 x 35 | 135 |
| 27 | 276 | | | | | 10 x 40 | 165 |
| 33 | 336 | 10 x 40 | 245 | 10 x 45 | 220 | 10 x 45 | 200 |
| 39 | 396 | 10 x 45 | 320 | 10 x 50 12.5 x 35 | 245 | 10 x 55 12.5 x 35 | 255 |
| 47 | 476 | 10 x 55 12.5 x 35 | 360 | 10 x 60 12.5 x 35 | 295 | 12.5 x 40 | 305 |
| 56 | 566 | 12.5 x 40 | 400 | 12.5 x 40 | 345 | 12.5 x 45 | 350 |
| 68 | 686 | 12.5 x 45 | 465 | 12.5 x 50 | 400 | 12.5 x 55 | 400 |
| 82 | 826 | 12.5 x 55 | 500 | 12.5 x 60 | 460 | 12.5 x 51 | 420 |

Maximum Allowable Ripple Current (mArms) at 105°C 120Hz

Case Size ΦD x L (mm)

Specifications are subject to change without notice. Should a safety or technical concern arise regarding the product, please be sure to contact our sales offices or agents immediately.

FEATURES

- 105°C high temperature and high voltage, load life : 10,000 hours.
- For slim size adaptor, LCD / LED-TV and LCD-Monitor power.



SPECIFICATIONS

| Item | Performance Characteristics | | | | | | |
|---------------------------------|---|---|------|------|------|------|------|
| Operating Temperature Range | -25 to +105°C | | | | | | |
| Rated Working Voltage Range | 200 to 450V | | | | | | |
| Nominal Capacitance Range | 22 to 220μF | | | | | | |
| Capacitance Tolerance | ±20% at 120Hz, +20°C | | | | | | |
| Leakage Current | I ≤ 0.02CV + 25 (μA) after 2 minutes application of rated working voltage at +20°C | | | | | | |
| tan δ (120Hz, +20°C) | Working Voltage (V) | 200 | 220 | 250 | 400 | 420 | 450 |
| | tan δ (max.) | 0.20 | 0.20 | 0.20 | 0.24 | 0.24 | 0.24 |
| Low Temperature Characteristics | Impedance ratio max. at 120Hz | | | | | | |
| | Rated Voltage (V) Z-25°C / Z+20°C | 200 | 220 | 250 | 400 | 420 | 450 |
| High Temperature Loading | Test time : 10,000 hours | Post test requirements at +20°C | | | | | |
| | Test temperature : +105°C Test conditions : Rated DC working voltage with rated ripple current | Leakage current : ≤ Initial specified value Cap. change : within ±20% of the initial measured value tan δ : ≤ 200% of the initial specified value | | | | | |
| Shelf Life | At +105°C no voltage applied after 1,000 hours and then being stabilized at +20°C the capacitors shall meet the following limits Leakage current : ≤ Initial specified value Cap. change : within ±20% of the initial measured value tan δ : ≤ 200% of the initial specified value | | | | | | |
| Industrial Standard | JIS C - 5101-4 (IEC 60384-4) | | | | | | |

CASE SIZE TABLE



| | | |
|----|-----|------|
| ΦD | 10 | 12.5 |
| F | 5.0 | 5.0 |
| Φd | 0.6 | 0.6 |
| α | 2.0 | |
| β | 1.0 | |

RIPPLE CURRENT MULTIPLIER

Frequency Coefficient

| Coefficient | 50 | 120 | 300 | 1K | 10k~ |
|---------------|------|------|------|------|------|
| Rated Voltage | 0.80 | 1.00 | 1.25 | 1.40 | 1.60 |

PART NUMBER SYSTEM (EXAMPLE : 250V 150μF)

| | | | | | | | |
|---------------------|----|-----|---|----|----|------|------|
| 1 | 23 | 456 | 7 | 89 | 10 | 1112 | 1314 |
| E | RY | 157 | M | 2E | I | 50 | RR |
| Type (Radial Bulk) | | | | | | | |
| Case Length (50mm) | | | | | | | |
| Diameter (12.5mm) | | | | | | | |
| Voltage (250V) | | | | | | | |
| Tolerance (±20%) | | | | | | | |
| Capacitance (150μF) | | | | | | | |
| Series | | | | | | | |
| E-CAP | | | | | | | |

STANDARD RATINGS

| Voltage (Code) | | 200V (2D) | | 220V (2N) | | 250V (2E) | |
|----------------|------|----------------------|----------------|-----------|----------------|----------------------|----------------|
| Cap. (μF) | Code | Case Size | Ripple Current | Case Size | Ripple Current | Case Size | Ripple Current |
| 82 | 826 | | | | | 10 x 45 | 390 |
| 100 | 107 | 10 x 45 | 420 | 10 x 45 | 430 | 10 x 55 12.5 x 35 | 440 |
| 120 | 127 | 10 x 50 | 435 | 10 x 55 | 490 | 12.5 x 40 | 505 |
| 150 | 157 | 10 x 60 12.5 x 40 | 500 | 12.5 x 40 | 550 | 12.5 x 50 | 590 |
| 180 | 187 | 12.5 x 45 | 580 | 12.5 x 50 | 640 | 12.5 x 55 | 625 |
| 220 | 227 | 12.5 x 55 | 650 | 12.5 x 60 | 700 | | |

Maximum Allowable Ripple Current (mArms) at 105°C 120Hz

Case Size ΦD x L (mm)

| Voltage (Code) | | 400V (2G) | | 420V (2M) | | 450V (2W) | |
|----------------|------|----------------------|----------------|----------------------|----------------|----------------------|----------------|
| Cap. (μF) | Code | Case Size | Ripple Current | Case Size | Ripple Current | Case Size | Ripple Current |
| 22 | 226 | | | | | 10 x 40 | 145 |
| 27 | 276 | | | | | 10 x 45 | 175 |
| 33 | 336 | 10 x 40 | 245 | 10 x 45 | 220 | 10 x 50 12.5 x 35 | 210 220 |
| 39 | 396 | 10 x 45 | 320 | 10 x 50 12.5 x 35 | 245 | 10 x 60 12.5 x 40 | 260 |
| 47 | 476 | 10 x 55 12.5 x 35 | 360 | 10 x 60 12.5 x 35 | 295 | 12.5 x 45 | 315 |
| 56 | 566 | 12.5 x 40 | 400 | 12.5 x 45 | 355 | 12.5 x 50 | 365 |
| 68 | 686 | 12.5 x 45 | 465 | 12.5 x 50 | 400 | 12.5 x 60 | 410 |
| 82 | 826 | 12.5 x 55 | 500 | 12.5 x 60 | 460 | | |

Maximum Allowable Ripple Current (mArms) at 105°C 120Hz

Case Size ΦD x L (mm)

Specifications are subject to change without notice. Should a safety or technical concern arise regarding the product, please be sure to contact our sales offices or agents immediately.

CASE SIZE TABLE

SW-Type

$\phi D = \phi 20 \sim \phi 40$

PC Board Mounting Holes

Unit : mm

SZ-Type

$\phi D = \phi 20 \sim \phi 40$

PC Board Mounting Holes

Unit : mm

SG-Type

| | | | | | |
|----------|----|----|----|----|----|
| ϕD | 35 | 40 | 50 | 63 | 76 |
| P | 14 | 14 | 18 | 25 | 25 |

PC Board Mounting Holes

Unit : mm

SX-Type

$\phi D = \phi 35 \sim \phi 50$

PC Board Mounting Holes

Unit : mm

LD-Type

$\phi D = \phi 30 \sim \phi 40$

PC Board Mounting Holes

Unit : mm

ST-Type

$\phi D = \phi 25 \sim \phi 35$

Unit : mm

CASE SIZE TABLE

FE-Type

Unit : mm

VO-Type

| D | h | a |
|----|----|----|
| 20 | 10 | 10 |
| 30 | 10 | 10 |
| 35 | 10 | 10 |
| 40 | 10 | 20 |
| 50 | 10 | 20 |

Unit : mm

VO-Type
成品带螺柱

| D | h | a | B |
|----|----|----|----------|
| 20 | 10 | 10 | M8 x 12 |
| 30 | 10 | 10 | M8 x 12 |
| 35 | 10 | 10 | M8 x 12 |
| 40 | 10 | 20 | M8 x 12 |
| 50 | 10 | 20 | M12 x 16 |

Unit : mm

| | thread | max. tightening torque |
|----------|--------|------------------------|
| mounting | M8 | 4 Nm |
| mounting | M12 | 10 Nm |

FEATURES

- Directly mountable on printed circuit board without holders.
- Smaller in sizes than ordinary capacitors.
- Terminal spacing fixed at 10mm for PC board plug in.
- Aluminum case designed with explosion-proof vent.



SPECIFICATIONS

| Item | Performance Characteristics | |
|---------------------------------|---|---|
| Operating Temperature Range | -40 to +85°C | -25 to +85°C |
| Rated Working Voltage Range | 10 to 250V | 315 to 500V |
| Nominal Capacitance Range | 56 to 82000µF | |
| Capacitance Tolerance | ±20% at 120Hz, +20°C | |
| Leakage Current | I ≤ 3√CV (µA) after 5 minutes application of rated working voltage at +20°C | |
| tan δ (120Hz, +20°C) | Working Voltage (V) | 10 16 25 35 50 63 80 100 |
| | tan δ (max.) | 0.55 0.50 0.45 0.40 0.35 0.30 0.25 0.20 |
| | Working Voltage (V) | 160~250 315~420 450~500 |
| | tan δ (max.) | 0.15 0.15 0.20 |
| | For capacitance value >33000µF, add following calculated value: $\frac{(\text{rated capacitance}) - 33000\mu\text{F}}{10000\mu\text{F}} \times 0.1$ | |
| Low Temperature Characteristics | Impedance ratio max. at 120Hz | |
| | Working Voltage (V) | 10~100 160~250 315~385 400~450 500 |
| | Z-25°C / Z+20°C | 4 3 5 8 8 |
| | Z-40°C / Z+20°C | 15 15 - - - |
| High Temperature Loading | Test time : 2,000 hours | Post test requirements at +20°C |
| | Test temperature : +85°C | Leakage current : ≤Initial specified value |
| | Test conditions : Rated DC working voltage with rated ripple current | Cap. change : within ±20% of the initial measured value |
| | | tan δ : ≤200% of the initial specified value |
| Shelf Life | At +85°C no voltage applied after 1,000 hours and then being stabilized at +20°C the capacitors shall meet the following limits | |
| | Leakage current : ≤Initial specified value | |
| | Cap. change : within ±15% of the initial measured value | |
| | tan δ : ≤150% of the initial specified value | |
| Industrial Standard | JIS C - 5101-4 (IEC 60384-4) | |

RIPPLE CURRENT MULTIPLIER

Frequency Coefficient

| Coefficient | Freq. (Hz) | Rated Voltage | | | |
|-------------|------------|---------------|------|------|---------|
| | | 60 | 120 | 1k | 10k~50k |
| 0.90 | 10~100V | 0.90 | 1.00 | 1.15 | 1.25 |
| | 160~250V | 0.80 | 1.00 | 1.15 | 1.47 |
| | 315~500V | 0.80 | 1.00 | 1.15 | 1.47 |

PART NUMBER SYSTEM (EXAMPLE : 250V 330µF)

| | | | | | | | |
|---|-----|-------|---|-----|----|-------|-------|
| 1 | 2 3 | 4 5 6 | 7 | 8 9 | 10 | 11 12 | 13 14 |
| E | LP | 337 | M | 2E | N | 30 | SW |

Type (Terminal Code)
 Case Length (30mm)
 Diameter (22mm)
 Voltage (250V)
 Tolerance (±20%)
 Capacitance (330µF)
 Series
 E-CAP

STANDARD RATINGS

| Voltage (Code) | | 10V (1A) | | 16V (1C) | | 25V (1E) | | 35V (1V) | |
|----------------|------|-----------|----------------|-----------|----------------|-----------|----------------|-----------|----------------|
| Cap. (μF) | Code | Case Size | Ripple Current | Case Size | Ripple Current | Case Size | Ripple Current | Case Size | Ripple Current |
| 2700 | 278 | | | | | | | 20 x 25 | 1.76 |
| 3300 | 338 | | | | | | | 20 x 30 | 2.14 |
| 3900 | 398 | | | | | | | 20 x 30 | 2.28 |
| 4700 | 478 | | | | | 20 x 25 | 2.18 | 22 x 25 | 2.22 |
| | | | | | | | | 20 x 35 | 2.46 |
| | | | | | | | | 22 x 30 | 2.46 |
| 5600 | 568 | | | | | 20 x 30 | 2.33 | 25 x 25 | 2.43 |
| | | | | | | 22 x 25 | 2.31 | 22 x 35 | 2.79 |
| | | | | | | | | 25 x 30 | 2.75 |
| 6800 | 688 | | | 20 x 25 | 2.33 | 20 x 35 | 2.56 | 22 x 40 | 2.97 |
| | | | | | | 22 x 30 | 2.56 | 25 x 30 | 2.89 |
| | | | | | | | | 30 x 25 | 3.09 |
| 8200 | 828 | | | 20 x 30 | 2.56 | 20 x 40 | 2.91 | 22 x 45 | 3.47 |
| | | | | | | 22 x 30 | 2.86 | 25 x 35 | 3.33 |
| | | | | 22 x 25 | 2.56 | 25 x 25 | 2.78 | 30 x 30 | 3.29 |
| 10000 | 109 | 20 x 25 | 2.22 | 20 x 35 | 2.85 | 22 x 35 | 3.31 | 22 x 50 | 3.75 |
| | | | | 22 x 30 | 2.89 | 25 x 30 | 3.16 | 25 x 40 | 3.65 |
| 12000 | 129 | 20 x 30 | 2.44 | 20 x 40 | 3.20 | 22 x 40 | 3.77 | 30 x 30 | 3.61 |
| | | 22 x 25 | 2.41 | 22 x 30 | 3.13 | 25 x 35 | 3.63 | 25 x 45 | 4.15 |
| | | | | 25 x 25 | 3.01 | 30 x 25 | 3.80 | 30 x 35 | 4.14 |
| 15000 | 159 | 20 x 35 | 2.90 | 22 x 35 | 3.69 | 22 x 50 | 4.21 | 35 x 30 | 4.27 |
| | | 22 x 30 | 2.88 | 25 x 30 | 3.64 | 25 x 40 | 4.10 | 30 x 40 | 4.80 |
| | | 25 x 25 | 2.88 | 30 x 25 | 3.73 | 30 x 30 | 4.00 | 35 x 35 | 4.95 |
| 18000 | 189 | 20 x 40 | 3.31 | 22 x 40 | 3.98 | 25 x 45 | 4.68 | 30 x 45 | 5.30 |
| | | 22 x 35 | 3.22 | 25 x 35 | 3.98 | 30 x 35 | 4.66 | 35 x 40 | 5.71 |
| | | 25 x 30 | 3.08 | 30 x 30 | 3.88 | 35 x 30 | 4.68 | | |
| 22000 | 229 | 22 x 40 | 3.79 | 22 x 50 | 4.52 | 30 x 40 | 5.33 | | |
| | | 25 x 30 | 3.66 | 25 x 40 | 4.44 | | | 35 x 45 | 6.38 |
| | | 30 x 25 | 3.53 | 30 x 30 | 4.38 | 35 x 35 | 5.26 | | |
| 27000 | 279 | 22 x 45 | 4.04 | 25 x 45 | 4.98 | 30 x 45 | 6.02 | | |
| | | 25 x 35 | 4.04 | 30 x 35 | 4.95 | | | 35 x 50 | 6.90 |
| | | 30 x 30 | 3.99 | 35 x 30 | 4.82 | 35 x 40 | 6.02 | | |
| 33000 | 339 | 22 x 50 | 4.58 | 25 x 50 | 5.49 | | | | |
| | | 25 x 40 | 4.56 | 30 x 40 | 5.60 | 35 x 45 | 6.75 | | |
| | | 30 x 30 | 4.58 | 35 x 30 | 5.46 | | | | |
| 39000 | 399 | 25 x 45 | 5.29 | 30 x 45 | 6.21 | | | | |
| | | 30 x 35 | 5.21 | 35 x 35 | 6.12 | 35 x 50 | 7.56 | | |
| | | 35 x 30 | 5.50 | | | | | | |
| 47000 | 479 | 25 x 50 | 5.78 | 30 x 50 | 6.93 | | | | |
| | | 30 x 40 | 5.78 | 35 x 40 | 6.89 | | | | |
| | | 35 x 35 | 5.55 | | | | | | |
| 56000 | 569 | 30 x 45 | 6.59 | 35 x 45 | 7.69 | | | | |
| | | 35 x 35 | 6.40 | | | | | | |
| 68000 | 689 | 30 x 50 | 7.50 | | | | | | |
| | | 35 x 40 | 7.48 | | | | | | |
| 82000 | 829 | 35 x 50 | 8.50 | | | | | | |

Maximum Allowable Ripple Current (Arms) at 85°C 120Hz

Case Size ΦD x L (mm)

Specifications are subject to change without notice. Should a safety or technical concern arise regarding the product, please be sure to contact our sales offices or agents immediately.

STANDARD RATINGS

| Voltage (Code) | | 50V (1H) | | 63V (1J) | | 80V (1K) | | 100V (2A) | |
|----------------|------|-----------|----------------|-----------|----------------|-----------|----------------|-----------|----------------|
| Cap. (μF) | Code | Case Size | Ripple Current | Case Size | Ripple Current | Case Size | Ripple Current | Case Size | Ripple Current |
| 680 | 687 | | | | | | | 20 x 25 | 1.66 |
| 820 | 827 | | | | | | | 20 x 30 | 1.85 |
| | | | | | | | | 22 x 25 | 1.86 |
| 1000 | 108 | | | | | 20 x 25 | 1.56 | 20 x 35 | 2.02 |
| | | | | | | | | 22 x 30 | 2.02 |
| 1200 | 128 | | | | | 20 x 30 | 1.80 | 20 x 40 | 2.12 |
| | | | | | | 22 x 25 | 1.77 | 22 x 30 | 2.12 |
| 1500 | 158 | | | 20 x 25 | 1.69 | 20 x 35 | 2.10 | 22 x 35 | 2.45 |
| | | | | | | 22 x 30 | 2.01 | 25 x 30 | 2.47 |
| 1800 | 188 | 20 x 25 | 1.70 | 20 x 30 | 2.04 | 20 x 40 | 2.30 | 22 x 40 | 2.77 |
| | | | | 22 x 25 | 1.90 | 22 x 30 | 2.11 | 25 x 35 | 2.81 |
| 2200 | 228 | 20 x 30 | 2.07 | 20 x 35 | 2.40 | 22 x 40 | 2.53 | 22 x 45 | 3.15 |
| | | | | 22 x 25 | 1.93 | 22 x 30 | 2.35 | 25 x 30 | 2.53 |
| 2700 | 278 | 20 x 35 | 2.21 | 25 x 25 | 2.30 | 30 x 25 | 2.56 | 30 x 30 | 3.17 |
| | | | | 20 x 40 | 2.52 | 22 x 45 | 2.93 | 25 x 45 | 3.66 |
| 3300 | 338 | 22 x 30 | 2.41 | 22 x 35 | 2.50 | 25 x 35 | 2.93 | 30 x 35 | 3.65 |
| | | | | 25 x 30 | 2.52 | 30 x 30 | 2.91 | 35 x 30 | 3.77 |
| 3900 | 398 | 20 x 40 | 2.41 | 22 x 40 | 2.72 | 22 x 50 | 3.23 | 25 x 50 | 4.15 |
| | | | | 22 x 30 | 2.41 | 25 x 30 | 2.74 | 25 x 40 | 3.29 |
| 4700 | 478 | 25 x 25 | 2.38 | 30 x 25 | 2.78 | 30 x 30 | 3.25 | 35 x 35 | 4.07 |
| | | | | 22 x 35 | 2.72 | 22 x 45 | 3.09 | 25 x 45 | 3.62 |
| 5600 | 568 | 25 x 30 | 2.68 | 25 x 35 | 3.13 | 30 x 35 | 3.70 | 35 x 35 | 4.61 |
| | | | | 22 x 40 | 3.02 | 22 x 50 | 3.69 | 25 x 50 | 4.28 |
| 6800 | 688 | 25 x 30 | 3.07 | 25 x 40 | 3.59 | 30 x 40 | 4.23 | 35 x 40 | 5.23 |
| | | | | 30 x 25 | 3.01 | 30 x 30 | 3.54 | 35 x 30 | 4.12 |
| 8200 | 828 | 22 x 45 | 3.43 | 25 x 45 | 4.01 | 30 x 45 | 4.70 | | |
| | | | | 25 x 35 | 3.47 | 30 x 35 | 4.00 | | |
| 10000 | 109 | 30 x 30 | 3.43 | 35 x 30 | 3.75 | 35 x 35 | 4.64 | | |
| | | | | 22 x 50 | 3.94 | 25 x 50 | 4.52 | 30 x 50 | 5.27 |
| 12000 | 129 | 25 x 40 | 3.87 | 30 x 40 | 4.55 | | | 35 x 50 | 6.01 |
| | | | | 30 x 35 | 3.93 | 35 x 30 | 4.44 | 35 x 40 | 5.24 |
| 15000 | 159 | 25 x 45 | 4.44 | 30 x 45 | 5.12 | | | | |
| | | | | 30 x 35 | 4.47 | 30 x 45 | 5.12 | 35 x 45 | 5.89 |
| 18000 | 189 | 35 x 30 | 4.41 | 35 x 35 | 5.05 | | | | |
| | | | | 30 x 40 | 5.08 | 30 x 50 | 5.78 | 35 x 50 | 6.63 |
| 12000 | 129 | 35 x 35 | 4.92 | 35 x 40 | 5.75 | | | | |
| | | | | 30 x 50 | 5.72 | 35 x 45 | 6.47 | | |
| 15000 | 159 | 35 x 45 | 6.56 | | | | | | |
| 18000 | 189 | 35 x 50 | 7.14 | | | | | | |

Maximum Allowable Ripple Current (Arms) at 85°C 120Hz

Case Size ΦD x L (mm)

Specifications are subject to change without notice. Should a safety or technical concern arise regarding the product, please be sure to contact our sales offices or agents immediately.

STANDARD RATINGS

| Voltage (Code) | | 160V (2C) | | 180V (2P) | | 200V (2D) | | 220V (2N) | |
|----------------|------|-------------------------------|----------------------|-------------------------------|----------------------|-------------------------------|----------------------|-------------------------------|----------------------|
| Cap. (μF) | Code | Case Size | Ripple Current | Case Size | Ripple Current | Case Size | Ripple Current | Case Size | Ripple Current |
| 180 | 187 | | | | | | | 20 x 25 | 1.11 |
| 220 | 227 | | | | | 20 x 25 | 1.19 | 20 x 25 22 x 25 | 1.23 1.30 |
| 270 | 277 | 20 x 25 | 1.28 | 20 x 25 | 1.29 | 20 x 30 22 x 25 | 1.39 1.37 | 20 x 30 22 x 25 | 1.46 1.42 |
| 330 | 337 | 20 x 25 | 1.55 | 20 x 30 22 x 25 | 1.77 1.49 | 20 x 30 22 x 25 | 1.56 1.51 | 20 x 35 22 x 30 25 x 25 | 1.64 1.59 1.59 |
| 390 | 397 | 20 x 30 22 x 25 | 1.63 1.63 | 20 x 30 22 x 25 | 1.84 1.84 | 20 x 35 22 x 30 25 x 25 | 1.74 1.73 1.71 | 20 x 40 22 x 35 25 x 25 | 1.79 1.80 1.75 |
| 470 | 477 | 20 x 35 22 x 30 25 x 25 | 1.90 1.86 1.86 | 20 x 35 22 x 30 25 x 25 | 1.91 1.91 2.08 | 20 x 40 22 x 30 25 x 30 | 2.03 1.97 1.95 | 22 x 35 25 x 30 30 x 25 | 2.06 2.08 2.16 |
| 560 | 567 | 20 x 40 22 x 30 25 x 30 | 2.14 2.15 2.15 | 20 x 40 22 x 35 25 x 25 | 2.15 2.25 2.25 | 22 x 40 25 x 30 30 x 25 | 2.18 2.15 2.15 | 22 x 40 25 x 35 30 x 25 | 2.22 2.38 2.18 |
| 680 | 687 | 22 x 40 25 x 30 30 x 25 | 2.35 2.33 2.33 | 22 x 35 25 x 30 30 x 25 | 2.48 2.50 2.46 | 22 x 45 25 x 35 30 x 30 | 2.48 2.48 2.48 | 22 x 45 25 x 40 30 x 30 | 2.62 2.56 2.52 |
| 820 | 827 | 22 x 45 25 x 35 30 x 30 | 2.68 2.65 2.64 | 22 x 40 25 x 35 30 x 25 | 2.86 2.75 2.69 | 22 x 50 25 x 40 30 x 30 | 2.81 2.79 2.75 | 25 x 45 30 x 35 35 x 30 | 2.91 2.84 2.79 |
| 1000 | 108 | 22 x 50 25 x 40 30 x 30 | 3.02 3.00 2.96 | 25 x 40 30 x 30 | 3.06 3.10 | 25 x 45 30 x 35 35 x 30 | 3.28 3.15 3.25 | 25 x 50 30 x 40 35 x 30 | 3.53 3.36 3.29 |
| 1200 | 128 | 25 x 45 30 x 35 35 x 30 | 3.43 3.41 3.40 | 25 x 45 30 x 35 35 x 30 | 3.63 3.55 3.49 | 25 x 50 30 x 40 35 x 35 | 3.61 3.61 3.57 | 30 x 45 35 x 35 | 3.72 3.68 |
| 1500 | 158 | 30 x 40 35 x 35 | 3.96 3.94 | 30 x 40 35 x 35 | 4.10 4.02 | 30 x 45 35 x 40 | 4.13 4.06 | 35 x 40 | 4.10 |
| 1800 | 188 | 30 x 45 35 x 35 | 4.31 4.28 | 30 x 45 35 x 35 | 4.55 4.54 | 35 x 45 | 4.59 | 35 x 45 | 4.52 |
| 2200 | 228 | 35 x 40 | 4.96 | 35 x 40 | 4.83 | 35 x 50 | 5.25 | | |
| 2700 | 278 | 35 x 50 | 5.57 | 35 x 50 | 5.30 | | | | |

Maximum Allowable Ripple Current (Arms) at 85°C 120Hz

Case Size Φ D x L (mm)

Specifications are subject to change without notice. Should a safety or technical concern arise regarding the product, please be sure to contact our sales offices or agents immediately.

STANDARD RATINGS

| Voltage (Code) | | 250V (2E) | | 315V (2F) | | 350V (2V) | | 385V (2Y) | |
|----------------|------|-----------|----------------|-----------|----------------|-----------|----------------|-----------|----------------|
| Cap. (μF) | Code | Case Size | Ripple Current | Case Size | Ripple Current | Case Size | Ripple Current | Case Size | Ripple Current |
| 68 | 686 | | | | | | | 20 x 25 | 0.68 |
| 82 | 826 | | | | | | | 20 x 30 | 0.74 |
| | | | | | | | | 22 x 25 | 0.76 |
| 100 | 107 | | | | | | | 20 x 30 | 0.86 |
| | | | | | | | | 22 x 30 | 0.89 |
| 120 | 127 | | | | | 20 x 30 | 0.96 | 20 x 35 | 0.96 |
| | | | | | | 22 x 25 | 1.04 | 25 x 25 | 1.02 |
| 150 | 157 | | | | | 20 x 30 | 1.10 | 20 x 40 | 1.10 |
| | | | | 20 x 30 | 1.00 | 22 x 30 | 1.20 | 22 x 35 | 1.12 |
| | | | | | | 25 x 25 | 1.22 | 25 x 30 | 1.14 |
| 180 | 187 | 20 x 25 | 1.20 | 20 x 35 | 1.13 | 20 x 35 | 1.24 | 22 x 40 | 1.27 |
| | | | | 22 x 30 | 1.29 | 22 x 30 | 1.34 | 25 x 35 | 1.30 |
| | | | | 25 x 25 | 1.38 | 25 x 25 | 1.37 | 30 x 25 | 1.37 |
| 220 | 227 | 20 x 30 | 1.26 | 20 x 40 | 1.29 | 22 x 35 | 1.47 | 22 x 45 | 1.42 |
| | | | | 22 x 35 | 1.41 | 25 x 30 | 1.53 | 25 x 35 | 1.48 |
| | | 22 x 25 | 1.24 | 25 x 30 | 1.47 | 30 x 25 | 1.54 | 30 x 30 | 1.49 |
| 270 | 277 | 20 x 30 | 1.42 | 22 x 40 | 1.70 | 22 x 40 | 1.70 | 25 x 40 | 1.61 |
| | | | | 25 x 35 | 1.73 | 25 x 35 | 1.73 | 30 x 35 | 16.4 |
| | | 22 x 30 | 1.50 | 25 x 30 | 1.70 | 30 x 25 | 1.80 | 30 x 35 | 16.4 |
| 330 | 337 | 20 x 35 | 1.68 | 22 x 45 | 1.91 | 22 x 45 | 1.87 | 25 x 50 | 1.80 |
| | | | | 25 x 35 | 1.94 | 25 x 40 | 1.97 | 30 x 40 | 1.85 |
| | | 25 x 25 | 1.61 | 30 x 30 | 1.98 | 30 x 30 | 2.03 | 35 x 30 | 1.87 |
| 390 | 397 | 20 x 40 | 1.92 | 22 x 50 | 2.07 | 25 x 40 | 2.14 | 30 x 40 | 2.05 |
| | | | | 22 x 35 | 1.88 | 25 x 40 | 2.11 | 30 x 35 | 2.23 |
| | | 25 x 30 | 1.88 | 30 x 30 | 2.15 | 35 x 30 | 2.30 | 35 x 35 | 2.07 |
| 470 | 477 | 22 x 40 | 2.15 | 25 x 45 | 2.39 | 30 x 35 | 2.53 | 30 x 50 | 2.26 |
| | | | | 30 x 35 | 2.38 | 35 x 30 | 2.55 | 35 x 40 | 2.26 |
| | | 30 x 25 | 2.04 | 35 x 30 | 2.36 | 35 x 30 | 2.55 | 35 x 40 | 2.26 |
| 560 | 567 | 22 x 45 | 2.48 | 30 x 40 | 2.63 | 30 x 40 | 2.73 | 35 x 45 | 2.59 |
| | | 25 x 35 | 2.35 | 35 x 35 | 2.69 | 35 x 35 | 2.75 | | |
| | | 30 x 30 | 2.35 | 35 x 35 | 2.69 | 35 x 35 | 2.75 | | |
| 680 | 687 | 25 x 40 | 2.67 | 30 x 45 | 2.80 | 35 x 40 | 3.15 | 35 x 50 | 2.80 |
| | | 30 x 35 | 2.71 | 35 x 40 | 3.05 | | | | |
| 820 | 827 | 25 x 50 | 3.01 | 30 x 50 | 3.28 | 35 x 45 | 3.47 | | |
| | | 30 x 35 | 2.98 | 35 x 45 | 3.45 | | | | |
| | | 35 x 30 | 2.96 | 35 x 45 | 3.45 | | | | |
| 1000 | 108 | 30 x 45 | 3.56 | 35 x 50 | 3.57 | 35 x 50 | 3.60 | | |
| | | 35 x 35 | 3.48 | | | | | | |
| 1200 | 128 | 30 x 50 | 3.99 | | | | | | |
| | | 35 x 40 | 3.84 | | | | | | |
| 1500 | 158 | 35 x 45 | 4.33 | | | | | | |
| 1800 | 188 | 35 x 50 | 4.54 | | | | | | |

Maximum Allowable Ripple Current (Arms) at 85°C 120Hz

Case Size ΦD x L (mm)

Specifications are subject to change without notice. Should a safety or technical concern arise regarding the product, please be sure to contact our sales offices or agents immediately.

STANDARD RATINGS

| Voltage (Code) | | 400V (2G) | | 420V (2M) | | 450V (2W) | | 500V (2H) | | | | | |
|----------------|------|-----------|----------------|-----------|----------------|-----------|----------------|-----------|----------------|---------|------|---------|------|
| Cap. (μF) | Code | Case Size | Ripple Current | Case Size | Ripple Current | Case Size | Ripple Current | Case Size | Ripple Current | | | | |
| 56 | 566 | | | | | 20 x 25 | 0.61 | | | | | | |
| 68 | 686 | 20 x 25 | 0.75 | 20 x 25 | 0.70 | 20 x 30 | 0.70 | | | | | | |
| | | | | | | 22 x 25 | 0.71 | | | | | | |
| | | | | | | 20 x 30 | 0.82 | 20 x 30 | 0.80 | 20 x 35 | 0.80 | | |
| 82 | 826 | 22 x 25 | 0.84 | 22 x 25 | 0.85 | 22 x 25 | 0.86 | | | | | | |
| | | | | | | 20 x 30 | 0.95 | 20 x 35 | 0.90 | 20 x 35 | 0.88 | 25 x 25 | 0.80 |
| | | | | | | 22 x 30 | 0.99 | 22 x 30 | 0.97 | 22 x 30 | 0.95 | 30 x 25 | 0.90 |
| 100 | 107 | 25 x 25 | 0.99 | 25 x 25 | 0.98 | 25 x 25 | 0.97 | 25 x 25 | 0.97 | | | | |
| | | | | | | 20 x 35 | 1.07 | 20 x 35 | 1.04 | 20 x 40 | 0.99 | 25 x 30 | 0.89 |
| | | | | | | 22 x 30 | 1.09 | 22 x 30 | 1.07 | 22 x 35 | 1.07 | | |
| 120 | 127 | 25 x 25 | 1.13 | 25 x 25 | 1.08 | 30 x 25 | 1.12 | 30 x 25 | 0.90 | | | | |
| | | | | | | 20 x 40 | 1.22 | 20 x 45 | 1.17 | 22 x 40 | 1.18 | | |
| | | | | | | 22 x 35 | 1.21 | 22 x 35 | 1.21 | 25 x 30 | 1.09 | | |
| 150 | 157 | 25 x 30 | 1.27 | 30 x 25 | 1.30 | 30 x 25 | 1.29 | 30 x 25 | 1.29 | | | | |
| | | | | | | 25 x 30 | 1.26 | 25 x 30 | 1.25 | 25 x 35 | 1.07 | | |
| | | | | | | 22 x 40 | 1.41 | 22 x 40 | 1.33 | 22 x 45 | 1.32 | | |
| 180 | 187 | 25 x 30 | 1.44 | 25 x 35 | 1.42 | 25 x 35 | 1.40 | 25 x 35 | 1.40 | | | | |
| | | | | | | 30 x 25 | 1.48 | 30 x 25 | 1.48 | 30 x 30 | 1.45 | 30 x 35 | 1.30 |
| | | | | | | 30 x 25 | 1.52 | 30 x 25 | 1.48 | 30 x 30 | 1.45 | | |
| 220 | 227 | 22 x 45 | 1.58 | 22 x 45 | 1.55 | 25 x 40 | 1.59 | 25 x 40 | 1.59 | | | | |
| | | | | | | 25 x 35 | 1.64 | 25 x 35 | 1.58 | 30 x 30 | 1.64 | 25 x 45 | 1.40 |
| | | | | | | 30 x 30 | 1.66 | 30 x 30 | 1.65 | 35 x 30 | 1.66 | | |
| 270 | 277 | 25 x 40 | 1.79 | 25 x 40 | 1.74 | 25 x 45 | 1.73 | 25 x 45 | 1.73 | | | | |
| | | | | | | 30 x 35 | 1.90 | 30 x 35 | 1.89 | 30 x 35 | 1.89 | 25 x 50 | 1.60 |
| | | | | | | 30 x 30 | 1.82 | 35 x 30 | 1.94 | 35 x 30 | 1.90 | 30 x 40 | 1.55 |
| 330 | 337 | 25 x 45 | 2.00 | 25 x 50 | 2.20 | 30 x 40 | 2.12 | 30 x 40 | 2.12 | | | | |
| | | | | | | 30 x 35 | 2.05 | 30 x 35 | 1.98 | 35 x 35 | 2.15 | 30 x 45 | 1.80 |
| | | | | | | 35 x 30 | 2.05 | 35 x 35 | 2.17 | 35 x 35 | 2.15 | | |
| 390 | 397 | 30 x 40 | 2.26 | 30 x 40 | 2.22 | 30 x 45 | 2.35 | 30 x 45 | 2.35 | | | | |
| | | | | | | 35 x 35 | 2.28 | 35 x 35 | 2.27 | 35 x 40 | 2.38 | 30 x 50 | 2.10 |
| 470 | 477 | 30 x 45 | 2.51 | 30 x 45 | 2.50 | 35 x 45 | 2.68 | | | | | | |
| | | | | | | 35 x 40 | 2.54 | 35 x 40 | 2.61 | | | | |
| 560 | 567 | 35 x 40 | 2.85 | 35 x 45 | 2.95 | | | | | | | | |
| 680 | 687 | 35 x 50 | 3.10 | | | | | | | | | | |

Maximum Allowable Ripple Current (Arms) at 85°C 120Hz

Case Size Φ D x L (mm)

FEATURES

- Designed for high grade audio equipment, giving priority to high fidelity sound quality.
- Suitable for use in mini-compos, CD, DAT players, cassette decks and etc.



SPECIFICATIONS

| Item | Performance Characteristics | | | |
|---------------------------------|---|---|-------|--------|
| Operating Temperature Range | -40 to +85°C | | | |
| Rated Working Voltage Range | 16 to 100V | | | |
| Nominal Capacitance Range | 680 to 10000µF | | | |
| Capacitance Tolerance | ±20% at 120Hz, +20°C | | | |
| Leakage Current | $I \leq 3\sqrt{CV}$ (µA) after 5 minutes application of rated working voltage at +20°C | | | |
| tan δ (120Hz, +20°C) | Working Voltage (V) | 16 | 25~63 | 80~100 |
| | tan δ (max.) | 0.30 | 0.25 | 0.22 |
| Low Temperature Characteristics | Impedance ratio max. at 120Hz | | | |
| | Working Voltage (V) | 16~100 | | |
| | Z-25°C / Z+20°C | 4 | | |
| | Z-40°C / Z+20°C | 15 | | |
| High Temperature Loading | Test time : 1,000 hours | Post test requirements at +20°C | | |
| | Test temperature : +85°C | Leakage current : ≤Initial specified value | | |
| | Test condition : Rated DC working voltage with rated ripple current | Cap. change : within ±20% of the initial measured value | | |
| | | tan δ : ≤200% of the initial specified value | | |
| Shelf Life | At +85°C no voltage applied after 1,000 hours and then being stabilized at +20°C the capacitors shall meet the following limits | | | |
| | Leakage current : ≤Initial specified value | | | |
| | Cap. change : within ±20% of the initial measured value | | | |
| | tan δ : ≤200% of the initial specified value | | | |
| Industrial Standard | JIS C - 5101-4 (IEC 60384-4) | | | |

RIPPLE CURRENT MULTIPLIER

Frequency Coefficient

| Coefficient | Rated Voltage | 60 | 120 | 1k | 10k~50k |
|-------------|---------------|------|------|------|---------|
| | 16~100V | 0.90 | 1.00 | 1.15 | 1.25 |

PART NUMBER SYSTEM (EXAMPLE : 16V 4700µF)

| 1 | 2 3 | 4 5 6 | 7 | 8 9 | 10 | 11 12 | 13 14 |
|---|-----|-------|---|-----|----|-------|-------|
| E | AP | 478 | M | 1C | N | 25 | SW |

Type (Terminal Code)
 Case Length (25mm)
 Diameter (22mm)
 Voltage (16V)
 Tolerance (±20%)
 Capacitance (4700µF)
 Series
 E-CAP

STANDARD RATINGS

| Voltage (Code) | | 16V (1C) | | 25V (1E) | | 35V (1V) | | 63V (1J) | |
|----------------|------|-----------|----------------|-----------|----------------|-----------|----------------|-----------|----------------|
| Cap. (µF) | Code | Case Size | Ripple Current | Case Size | Ripple Current | Case Size | Ripple Current | Case Size | Ripple Current |
| 680 | 687 | | | | | | | 22 x 25 | 0.75 |
| 1000 | 108 | | | | | | | 22 x 30 | 1.00 |
| | | | | | | | | 25 x 25 | 1.00 |
| | | | | | | | | 22 x 35 | 1.30 |
| 1500 | 158 | | | | | 22 x 25 | 1.15 | 25 x 30 | 1.30 |
| | | | | | | | | 30 x 25 | 1.35 |
| | | | | | | | | 22 x 45 | 1.75 |
| 2200 | 228 | | | 22 x 25 | 1.35 | 22 x 30 | 1.50 | 25 x 40 | 1.80 |
| | | | | | | 25 x 25 | 1.50 | 30 x 30 | 1.75 |
| | | | | | | | | 35 x 25 | 1.80 |
| 3300 | 338 | 22 x 20 | 1.35 | 22 x 30 | 1.80 | 22 x 35 | 1.95 | 25 x 50 | 2.45 |
| | | | | 25 x 25 | 1.80 | 25 x 30 | 1.95 | 30 x 40 | 2.45 |
| | | | | | | 30 x 25 | 2.00 | 35 x 30 | 2.40 |
| 4700 | 478 | 22 x 25 | 1.80 | 22 x 35 | 2.30 | 22 x 45 | 2.55 | 30 x 50 | 3.20 |
| | | | | 25 x 30 | 2.30 | 25 x 40 | 2.65 | | |
| | | | | 30 x 25 | 2.40 | 30 x 30 | 2.60 | 35 x 40 | 3.20 |
| | | | | | | 35 x 25 | 2.65 | | |
| 6800 | 688 | 22 x 35 | 2.25 | 22 x 45 | 2.75 | 25 x 50 | 3.10 | | |
| | | 25 x 30 | 2.25 | 25 x 40 | 2.80 | | | 35 x 50 | 3.75 |
| | | 30 x 25 | 2.35 | 30 x 30 | 2.75 | 30 x 40 | 3.10 | | |
| | | | | 35 x 25 | 2.85 | 35 x 30 | 3.00 | | |
| 10000 | 109 | 22 x 45 | 2.50 | 25 x 50 | 3.10 | 30 x 50 | 3.40 | | |
| | | 25 x 35 | 2.50 | | | | | | |
| | | 30 x 30 | 2.50 | 30 x 40 | 3.10 | | | | |
| | | 35 x 25 | 2.60 | 35 x 30 | 3.00 | 35 x 40 | 3.40 | | |

Maximum Allowable Ripple Current (Arms) at 85°C 120Hz

Case Size Φ D x L (mm)

| Voltage (Code) | | 80V (1K) | | 100V (2A) | |
|----------------|------|-----------|----------------|-----------|----------------|
| Cap. (µF) | Code | Case Size | Ripple Current | Case Size | Ripple Current |
| 680 | 687 | 22 x 30 | 0.90 | 22 x 35 | 0.95 |
| | | | | 25 x 30 | 1.00 |
| | | 25 x 25 | 0.90 | 30 x 25 | 1.00 |
| 1000 | 108 | 22 x 35 | 1.20 | 22 x 50 | 1.35 |
| | | 25 x 30 | 1.20 | 25 x 40 | 1.35 |
| | | 30 x 25 | 1.25 | 30 x 30 | 1.35 |
| | | | | 35 x 25 | 1.35 |
| 1500 | 158 | 22 x 50 | 1.70 | 25 x 50 | 1.80 |
| | | 25 x 40 | 1.65 | | |
| | | 30 x 30 | 1.65 | 30 x 40 | 1.85 |
| | | 35 x 25 | 1.65 | 35 x 25 | 1.35 |
| 2200 | 228 | 25 x 50 | 2.20 | 30 x 50 | 2.45 |
| | | 30 x 40 | 2.20 | | |
| | | 35 x 30 | 2.15 | 35 x 40 | 2.45 |
| 3300 | 338 | 30 x 50 | 3.00 | | |
| | | 35 x 40 | 2.95 | 35 x 40 | 2.45 |
| 4700 | 478 | 35 x 50 | 3.90 | | |

Maximum Allowable Ripple Current (Arms) at 85°C 120Hz

Case Size Φ D x L (mm)

Specifications are subject to change without notice. Should a safety or technical concern arise regarding the product, please be sure to contact our sales offices or agents immediately.

FEATURES

- Designed for withstanding vibration.
- Suitable for washing machines and etc.



SPECIFICATIONS

| Item | Performance Characteristics | | | | | |
|---------------------------------|---|--|---------|---|---------|-----|
| Operating Temperature Range | -40 to +85°C | -25 to +85°C | | | | |
| Rated Working Voltage Range | 10 to 250V | 315 to 500V | | | | |
| Nominal Capacitance Range | 56 to 82000µF | | | | | |
| Capacitance Tolerance | ±20% at 120Hz, +20°C | | | | | |
| Leakage Current | $I \leq 3\sqrt{CV}$ (µA) after 5 minutes application of rated working voltage at +20°C | | | | | |
| tan δ (120Hz, +20°C) | Working Voltage (V) | 10 16 25 35 50 63 80 | | | | |
| | tan δ (max.) | 0.55 0.50 0.45 0.40 0.35 0.30 0.25 | | | | |
| | Working Voltage (V) | 100 160~250 315~450 500 | | | | |
| | tan δ (max.) | 0.20 0.15 0.15 0.20 | | | | |
| | For capacitance value >33000µF, add following calculated value: $\frac{(\text{rated capacitance}) - 33000\mu\text{F}}{10000\mu\text{F}} \times 0.1$ | | | | | |
| Low Temperature Characteristics | Impedance ratio max. at 120Hz | | | | | |
| | Working Voltage (V) | 10~100 | 160~250 | 315~385 | 400~450 | 500 |
| | Z-25°C / Z+20°C | 4 | 3 | 5 | 8 | 8 |
| | Z-40°C / Z+20°C | 15 | 15 | - | - | - |
| High Temperature Loading | Test time | : 2,000 hours | | Post test requirements at +20°C | | |
| | Test temperature | : +85°C | | Leakage current : ≤Initial specified value | | |
| | Test condition | : Rated DC working voltage with rated ripple current | | Cap. change : within ±20% of the initial measured value | | |
| | | | | tan δ : ≤200% of the initial specified value | | |
| Shelf Life | At +85°C no voltage applied after 1,000 hours and then being stabilized at +20°C the capacitors shall meet the following limits | | | | | |
| | Leakage current : ≤Initial specified value | | | | | |
| | Cap. change : within ±15% of the initial measured value | | | | | |
| | tan δ : ≤150% of the initial specified value | | | | | |
| Industrial Standard | JIS C - 5101-4 (IEC 60384-4) | | | | | |

RIPPLE CURRENT MULTIPLIER

Frequency Coefficient

| Coefficient Rated Voltage | Freq. (Hz) | | | |
|------------------------------|------------|------|------|---------|
| | 60 | 120 | 1k | 10k-50k |
| 10~100V | 0.90 | 1.00 | 1.15 | 1.25 |
| 160~250V | 0.80 | 1.00 | 1.15 | 1.47 |
| 315~500V | 0.80 | 1.00 | 1.15 | 1.47 |

PART NUMBER SYSTEM (EXAMPLE : 160V 1000µF)

| | | | | | | | |
|---|----|-----|---|----|----|------|------|
| 1 | 23 | 456 | 7 | 89 | 10 | 1112 | 1314 |
| E | QP | 108 | M | 2C | O | 40 | SW |

Type (Terminal Code)
 Case Length (40mm)
 Diameter (25mm)
 Voltage (160V)
 Tolerance (±20%)
 Capacitance (1000µF)
 Series
 E-CAP

STANDARD RATINGS

| Voltage (Code) | | 10V (1A) | | 16V (1C) | | 25V (1E) | | 35V (1V) | |
|----------------|------|-----------|----------------|-----------|----------------|-----------|----------------|-----------|----------------|
| Cap. (µF) | Code | Case Size | Ripple Current | Case Size | Ripple Current | Case Size | Ripple Current | Case Size | Ripple Current |
| 2700 | 278 | | | | | | | 20 x 25 | 1.76 |
| 3300 | 338 | | | | | | | 20 x 30 | 2.14 |
| 3900 | 398 | | | | | | | 20 x 30 | 2.28 |
| | | | | | | | | 22 x 25 | 2.22 |
| 4700 | 478 | | | | | 20 x 25 | 2.18 | 20 x 35 | 2.46 |
| | | | | | | | | 22 x 30 | 2.46 |
| | | | | | | | | 25 x 25 | 2.43 |
| 5600 | 568 | | | | | 20 x 30 | 2.33 | 22 x 35 | 2.79 |
| | | | | | | 22 x 25 | 2.31 | 25 x 30 | 2.75 |
| 6800 | 688 | | | 20 x 25 | 2.33 | 20 x 35 | 2.56 | 22 x 40 | 2.89 |
| | | | | | | | | 25 x 30 | 2.89 |
| | | | | | | 22 x 30 | 2.56 | 30 x 25 | 3.09 |
| 8200 | 828 | 22 x 40 | 22 x 40 | 20 x 30 | 2.56 | 20 x 40 | 2.91 | 22 x 45 | 3.47 |
| | | 25 x 30 | 25 x 30 | 22 x 25 | 2.56 | 22 x 35 | 2.81 | 25 x 35 | 3.33 |
| | | 30 x 25 | 30 x 25 | 22 x 25 | 2.56 | 25 x 25 | 2.78 | 30 x 30 | 3.29 |
| 10000 | 109 | 20 x 25 | 2.22 | 20 x 35 | 2.85 | 22 x 35 | 3.18 | 22 x 50 | 3.59 |
| | | | | 22 x 30 | 2.81 | 25 x 30 | 3.16 | 25 x 40 | 3.59 |
| 12000 | 129 | 20 x 30 | 2.44 | 20 x 40 | 3.20 | 22 x 40 | 3.53 | 30 x 30 | 3.61 |
| | | | | 22 x 30 | 3.13 | 25 x 35 | 3.48 | 25 x 45 | 4.01 |
| | | 22 x 25 | 2.41 | 25 x 25 | 2.96 | 30 x 25 | 3.53 | 30 x 35 | 4.01 |
| 15000 | 159 | 20 x 35 | 2.90 | 22 x 35 | 3.69 | 22 x 50 | 4.08 | 35 x 30 | 4.02 |
| | | 22 x 30 | 2.88 | 25 x 30 | 3.64 | 25 x 40 | 4.00 | 30 x 40 | 4.80 |
| | | 25 x 25 | 2.88 | 30 x 25 | 3.73 | 30 x 30 | 4.00 | 35 x 35 | 4.08 |
| 18000 | 189 | 20 x 40 | 3.31 | 22 x 40 | 3.98 | 25 x 45 | 4.68 | 30 x 45 | 5.18 |
| | | 22 x 35 | 3.22 | 25 x 35 | 3.98 | 30 x 35 | 4.66 | 35 x 40 | 5.71 |
| | | 25 x 30 | 3.08 | 30 x 30 | 3.88 | 35 x 30 | 4.68 | | |
| 22000 | 229 | 22 x 40 | 3.79 | 22 x 50 | 4.52 | 30 x 40 | 5.19 | | |
| | | 25 x 30 | 3.66 | 25 x 40 | 4.44 | | | 35 x 45 | 6.38 |
| | | 30 x 25 | 3.53 | 30 x 30 | 4.38 | 35 x 35 | 5.20 | | |
| 27000 | 279 | 22 x 45 | 4.04 | 25 x 45 | 4.98 | 30 x 45 | 6.02 | | |
| | | 25 x 35 | 4.04 | 30 x 35 | 4.82 | | | 35 x 50 | 6.90 |
| | | 30 x 30 | 3.99 | 35 x 30 | 4.82 | 35 x 40 | 6.02 | | |
| 33000 | 339 | 22 x 50 | 4.58 | 25 x 50 | 5.49 | | | | |
| | | 25 x 40 | 4.56 | 30 x 40 | 5.38 | 35 x 45 | 6.75 | | |
| | | 30 x 30 | 4.58 | 35 x 35 | 5.33 | | | | |
| 39000 | 399 | 25 x 45 | 5.29 | 30 x 45 | 6.11 | | | | |
| | | 30 x 35 | 5.21 | | | 35 x 50 | 7.56 | | |
| | | 35 x 30 | 5.50 | 35 x 35 | 6.01 | | | | |
| 47000 | 479 | 25 x 50 | 5.78 | 30 x 50 | 6.80 | | | | |
| | | 30 x 40 | 5.78 | | | | | | |
| | | 35 x 35 | 5.55 | 35 x 40 | 6.80 | | | | |
| 56000 | 569 | 30 x 45 | 6.59 | 35 x 45 | 7.62 | | | | |
| | | 35 x 35 | 6.40 | | | | | | |
| 68000 | 689 | 30 x 50 | 7.50 | | | | | | |
| | | 35 x 40 | 7.48 | | | | | | |
| 82000 | 829 | 35 x 50 | 8.50 | | | | | | |

Maximum Allowable Ripple Current (Arms) at 85°C 120Hz

Case Size Φ D x L (mm)

Specifications are subject to change without notice. Should a safety or technical concern arise regarding the product, please be sure to contact our sales offices or agents immediately.



STANDARD RATINGS

| Voltage (Code) | | 50V (1H) | | 63V (1J) | | 80V (1K) | | 100V (2A) | |
|----------------|------|-----------|----------------|-----------|----------------|-----------|----------------|-----------|----------------|
| Cap. (μF) | Code | Case Size | Ripple Current | Case Size | Ripple Current | Case Size | Ripple Current | Case Size | Ripple Current |
| 680 | 687 | | | | | | | 20 x 25 | 1.66 |
| 820 | 827 | | | | | | | 20 x 30 | 1.85 |
| | | | | | | | | 22 x 25 | 1.86 |
| 1000 | 108 | | | | | 20 x 25 | 1.56 | 20 x 35 | 2.02 |
| | | | | | | | | 22 x 30 | 2.02 |
| 1200 | 128 | | | | | 20 x 30 | 1.80 | 20 x 40 | 2.12 |
| | | | | | | | | 22 x 30 | 2.12 |
| 1500 | 158 | | | | | 22 x 25 | 1.77 | 25 x 25 | 2.10 |
| | | | | | | 20 x 35 | 2.10 | 22 x 35 | 2.45 |
| 1800 | 188 | | | 20 x 25 | 1.69 | 22 x 30 | 2.01 | 25 x 30 | 2.43 |
| | | | | 20 x 30 | 2.04 | 20 x 40 | 2.30 | 22 x 40 | 2.77 |
| 2200 | 228 | 20 x 25 | 1.70 | 22 x 25 | 1.90 | 22 x 35 | 2.25 | 25 x 35 | 2.77 |
| | | | | | | 25 x 25 | 2.26 | 30 x 25 | 2.65 |
| 2700 | 278 | 20 x 30 | 2.07 | 20 x 35 | 2.40 | 22 x 40 | 2.53 | 22 x 45 | 3.12 |
| | | | | | | 22 x 30 | 2.35 | 25 x 30 | 2.53 |
| 3300 | 338 | 22 x 25 | 1.93 | 25 x 25 | 2.30 | 30 x 25 | 2.50 | 30 x 30 | 3.10 |
| | | | | | | 20 x 40 | 2.52 | 22 x 45 | 2.93 |
| 3900 | 398 | 20 x 35 | 2.21 | 22 x 35 | 2.50 | 25 x 35 | 2.93 | 25 x 45 | 3.61 |
| | | | | | | 22 x 30 | 2.21 | 30 x 35 | 3.60 |
| 4700 | 478 | | | 25 x 30 | 2.49 | 30 x 30 | 2.91 | 35 x 30 | 3.71 |
| | | 20 x 40 | 2.41 | 22 x 40 | 2.69 | 22 x 50 | 3.25 | 25 x 50 | 4.06 |
| 5600 | 568 | 22 x 30 | 2.41 | 25 x 30 | 2.69 | 25 x 40 | 3.25 | 30 x 40 | 4.05 |
| | | | | | | 25 x 25 | 2.38 | 30 x 30 | 3.23 |
| 6800 | 688 | 30 x 25 | 2.38 | 30 x 25 | 2.78 | 30 x 30 | 3.23 | 35 x 35 | 4.07 |
| | | | | | | 22 x 35 | 2.72 | 22 x 45 | 3.10 |
| 8200 | 828 | | | 25 x 35 | 3.09 | 25 x 45 | 3.62 | 30 x 45 | 4.60 |
| | | | | 30 x 30 | 3.09 | 30 x 35 | 3.62 | 35 x 35 | 4.50 |
| 10000 | 109 | 22 x 40 | 3.01 | 22 x 50 | 3.49 | 25 x 50 | 4.28 | 30 x 50 | 5.13 |
| | | | | | | 25 x 30 | 3.03 | 30 x 40 | 4.15 |
| 12000 | 129 | 30 x 25 | 3.01 | 30 x 30 | 3.37 | 35 x 30 | 4.10 | 35 x 40 | 5.12 |
| | | | | | | 22 x 45 | 3.43 | 25 x 45 | 3.80 |
| 15000 | 159 | 25 x 35 | 3.37 | 30 x 35 | 3.81 | 30 x 45 | 4.55 | 35 x 45 | 5.75 |
| | | | | | | 30 x 30 | 3.43 | 35 x 35 | 4.51 |
| 18000 | 189 | 30 x 30 | 3.43 | 35 x 30 | 3.75 | 35 x 35 | 4.51 | | |
| | | | | | | 22 x 50 | 3.94 | 25 x 50 | 4.41 |
| 22000 | 229 | 25 x 40 | 3.87 | 30 x 40 | 4.41 | 30 x 50 | 5.18 | 35 x 50 | 6.01 |
| | | | | | | 30 x 35 | 3.87 | 35 x 35 | 4.33 |
| 27000 | 279 | 25 x 45 | 4.37 | 30 x 45 | 4.90 | | | | |
| | | | | | | 30 x 45 | 5.83 | | |
| 33000 | 339 | 30 x 35 | 4.42 | 35 x 35 | 4.80 | | | | |
| | | | | | | 35 x 30 | 4.41 | | |
| 39000 | 399 | 30 x 40 | 5.02 | 30 x 50 | 5.49 | | | | |
| | | | | | | 35 x 35 | 4.92 | | |
| 47000 | 479 | 35 x 35 | 4.92 | 35 x 40 | 5.47 | | | | |
| | | | | | | 30 x 50 | 5.60 | | |
| 56000 | 569 | 35 x 40 | 5.60 | 35 x 50 | 6.30 | | | | |
| | | | | | | 35 x 45 | 6.44 | | |
| 68000 | 689 | 35 x 45 | 6.44 | | | | | | |
| | | | | | | 35 x 50 | 6.71 | | |

Maximum Allowable Ripple Current (Arms) at 85°C 120Hz

Case Size ΦD x L (mm)

Specifications are subject to change without notice. Should a safety or technical concern arise regarding the product, please be sure to contact our sales offices or agents immediately.

QP Large Can Aluminum Electrolytic Capacitors

STANDARD RATINGS

| Voltage (Code) | | 160V (2C) | | 180V (2P) | | 200V (2D) | | 220V (2N) | |
|----------------|------|-------------------------------|----------------------|-------------------------------|----------------------|-------------------------------|----------------------|-------------------------------|----------------------|
| Cap. (μF) | Code | Case Size | Ripple Current | Case Size | Ripple Current | Case Size | Ripple Current | Case Size | Ripple Current |
| 180 | 187 | | | | | | | 20 x 25 | 1.09 |
| 220 | 227 | | | | | 20 x 25 | 1.13 | 20 x 30 22 x 25 | 1.15 1.09 |
| 270 | 277 | 20 x 25 | 1.22 | 20 x 25 | 1.23 | 20 x 30 22 x 25 | 1.32 1.30 | 20 x 30 22 x 25 | 1.38 1.31 |
| 330 | 337 | 20 x 30 | 1.48 | 20 x 30 22 x 25 | 1.48 1.42 | 20 x 30 22 x 25 | 1.49 1.44 | 20 x 35 22 x 30 25 x 25 | 1.51 1.58 1.49 |
| 390 | 397 | 20 x 30 22 x 25 | 1.55 1.55 | 20 x 30 22 x 30 | 1.58 1.61 | 20 x 35 22 x 30 25 x 25 | 1.66 1.65 1.63 | 20 x 40 22 x 35 25 x 30 | 1.73 1.69 1.71 |
| 470 | 477 | 20 x 35 22 x 30 25 x 25 | 1.81 1.77 1.77 | 20 x 35 22 x 30 25 x 25 | 1.82 1.80 1.80 | 20 x 40 22 x 35 25 x 30 | 1.93 1.88 1.86 | 22 x 40 25 x 30 30 x 25 | 1.99 1.95 1.89 |
| 560 | 567 | 20 x 40 22 x 35 25 x 30 | 2.04 2.05 2.05 | 20 x 40 22 x 35 25 x 30 | 2.04 2.09 2.05 | 22 x 40 25 x 30 30 x 25 | 2.08 2.05 2.05 | 22 x 45 25 x 35 30 x 30 | 2.28 2.22 2.19 |
| 680 | 687 | 22 x 40 25 x 30 30 x 25 | 2.24 2.22 2.22 | 22 x 40 25 x 35 30 x 25 | 2.36 2.34 2.27 | 22 x 45 25 x 35 30 x 30 | 2.36 2.36 2.36 | 22 x 50 25 x 40 30 x 30 | 2.46 2.40 2.39 |
| 820 | 827 | 22 x 45 25 x 35 30 x 30 | 2.55 2.52 2.51 | 22 x 45 25 x 35 30 x 30 | 2.72 2.58 2.56 | 22 x 50 25 x 40 30 x 30 | 2.68 2.66 2.62 | 25 x 45 30 x 35 35 x 30 | 2.81 2.70 2.62 |
| 1000 | 108 | 22 x 50 25 x 40 30 x 30 | 2.88 2.86 2.82 | 25 x 45 30 x 35 | 2.91 2.95 | 25 x 45 30 x 35 35 x 30 | 3.12 3.00 2.96 | 25 x 50 30 x 40 35 x 35 | 3.13 3.08 3.05 |
| 1200 | 128 | 25 x 45 30 x 35 35 x 30 | 3.27 3.25 3.24 | 25 x 50 30 x 40 35 x 30 | 3.46 3.38 3.32 | 25 x 50 30 x 40 35 x 35 | 3.44 3.44 3.40 | 30 x 45 35 x 40 | 3.60 3.51 |
| 1500 | 158 | 30 x 40 35 x 35 | 3.77 3.75 | 30 x 45 35 x 35 | 3.90 3.83 | 30 x 50 35 x 40 | 3.93 3.87 | 35 x 45 | 3.92 |
| 1800 | 188 | 30 x 45 35 x 35 | 4.10 4.08 | 30 x 50 35 x 40 | 4.33 4.32 | 35 x 45 | 4.37 | | |
| 2200 | 228 | 35 x 45 | 4.72 | 35 x 45 | 4.60 | 35 x 50 | 5.00 | | |
| 2700 | 278 | 35 x 50 | 5.30 | 35 x 50 | 5.05 | | | | |

Maximum Allowable Ripple Current (Arms) at 85°C 120Hz

Case Size Φ D x L (mm)

STANDARD RATINGS

| Voltage (Code) | | 250V (2E) | | 315V (2F) | | 350V (2V) | | 385V (2Y) | |
|----------------|------|-----------|----------------|-----------|----------------|-----------|----------------|-----------|----------------|
| Cap. (μF) | Code | Case Size | Ripple Current | Case Size | Ripple Current | Case Size | Ripple Current | Case Size | Ripple Current |
| 68 | 686 | | | | | | | 20 x 25 | 0.60 |
| 82 | 826 | | | | | | | 20 x 30 | 0.67 |
| | | | | | | | | 22 x 25 | 0.70 |
| 100 | 107 | | | | | | | 20 x 30 | 0.80 |
| | | | | | | | | 22 x 30 | 0.82 |
| 120 | 127 | | | | | 20 x 30 | 0.91 | 20 x 35 | 0.89 |
| | | | | | | 22 x 25 | 0.99 | 25 x 25 | 0.95 |
| 150 | 157 | | | 20 x 30 | 0.95 | 20 x 35 | 1.05 | 20 x 40 | 1.05 |
| | | | | | | 22 x 30 | 1.14 | 22 x 35 | 1.04 |
| | | | | | | 25 x 25 | 1.16 | 25 x 30 | 1.08 |
| 180 | 187 | 20 x 25 | 1.14 | 20 x 35 | 1.08 | 20 x 40 | 1.18 | 20 x 40 | 1.18 |
| | | | | 22 x 30 | 1.23 | 22 x 35 | 1.28 | 25 x 35 | 1.20 |
| | | | | 25 x 25 | 1.31 | 25 x 30 | 1.30 | 30 x 25 | 1.28 |
| 220 | 227 | 20 x 30 | 1.20 | 20 x 40 | 1.23 | 22 x 40 | 1.40 | 22 x 45 | 1.33 |
| | | | | 22 x 35 | 1.34 | 25 x 35 | 1.46 | 25 x 35 | 1.44 |
| | | 22 x 25 | 1.18 | 25 x 30 | 1.40 | 30 x 25 | 1.47 | 30 x 30 | 1.40 |
| 270 | 277 | 20 x 30 | 1.35 | 22 x 40 | 1.60 | 22 x 45 | 1.62 | 25 x 40 | 1.56 |
| | | | | 22 x 30 | 1.43 | 25 x 30 | 1.62 | 25 x 35 | 1.65 |
| | | | | | | 30 x 30 | 1.71 | 30 x 35 | 1.62 |
| 330 | 337 | 20 x 35 | 1.60 | 22 x 45 | 1.82 | 22 x 50 | 1.78 | 25 x 50 | 1.80 |
| | | 22 x 30 | 1.58 | 25 x 35 | 1.85 | 25 x 40 | 1.88 | 30 x 40 | 1.85 |
| | | 25 x 25 | 1.53 | 30 x 30 | 1.89 | 30 x 35 | 1.93 | 35 x 30 | 1.85 |
| 390 | 397 | 20 x 40 | 1.83 | 22 x 50 | 1.97 | 25 x 45 | 2.04 | 30 x 40 | 2.04 |
| | | 22 x 35 | 1.79 | 25 x 40 | 2.01 | 30 x 35 | 2.12 | 35 x 35 | 2.06 |
| | | 25 x 30 | 1.79 | 30 x 30 | 2.05 | 35 x 30 | 2.19 | | |
| 470 | 477 | 22 x 40 | 2.05 | 25 x 45 | 2.20 | 30 x 40 | 2.41 | 30 x 50 | 2.27 |
| | | 25 x 35 | 2.05 | 30 x 35 | 2.27 | 35 x 35 | 2.43 | 35 x 40 | 2.30 |
| | | 30 x 25 | 1.94 | 35 x 30 | 2.25 | | | | |
| 560 | 567 | 22 x 45 | 2.36 | 30 x 40 | 2.50 | 30 x 45 | 2.60 | | |
| | | 25 x 35 | 2.24 | 35 x 35 | 2.56 | 35 x 35 | 2.62 | 35 x 45 | 2.57 |
| | | 30 x 30 | 2.24 | | | | | | |
| 680 | 687 | 25 x 40 | 2.54 | 30 x 45 | 2.67 | 35 x 40 | 3.00 | 35 x 50 | 2.80 |
| | | 30 x 35 | 2.58 | 35 x 40 | 2.90 | | | | |
| 820 | 827 | 25 x 50 | 2.87 | 30 x 50 | 3.12 | | | | |
| | | 30 x 35 | 2.84 | | | 35 x 50 | 3.30 | | |
| | | 35 x 30 | 2.82 | 35 x 45 | 3.29 | | | | |
| 1000 | 108 | 30 x 45 | 3.39 | 35 x 50 | 3.40 | | | | |
| | | 35 x 35 | 3.31 | | | | | | |
| 1200 | 128 | 30 x 50 | 3.80 | | | | | | |
| | | 35 x 40 | 3.66 | | | | | | |
| 1500 | 158 | 35 x 45 | 4.12 | | | | | | |
| 1800 | 188 | 35 x 50 | 4.31 | | | | | | |

Maximum Allowable Ripple Current (Arms) at 85°C 120Hz

Case Size ΦD x L (mm)

Specifications are subject to change without notice. Should a safety or technical concern arise regarding the product, please be sure to contact our sales offices or agents immediately.

STANDARD RATINGS

| Voltage (Code) | | 400V (2G) | | 420V (2M) | | 450V (2W) | | 500V (2H) | |
|----------------|------|-----------|----------------|-----------|----------------|-----------|----------------|-----------|----------------|
| Cap. (µF) | Code | Case Size | Ripple Current | Case Size | Ripple Current | Case Size | Ripple Current | Case Size | Ripple Current |
| 56 | 566 | | | | | 20 x 25 | 0.58 | | |
| 68 | 686 | 20 x 25 | 0.71 | 20 x 25 | 0.65 | 20 x 30 | 0.67 | | |
| | | | | | | 22 x 25 | 0.68 | | |
| 82 | 826 | 20 x 30 | 0.78 | 20 x 30 | 0.73 | 20 x 35 | 0.76 | | |
| | | 22 x 25 | 0.80 | 22 x 25 | 0.75 | 22 x 30 | 0.82 | | |
| 100 | 107 | 20 x 30 | 0.90 | 20 x 35 | 0.85 | 20 x 35 | 0.84 | | |
| | | | | 22 x 30 | 0.87 | 22 x 35 | 0.90 | 30 x 25 | 0.90 |
| | | 22 x 30 | 0.94 | 25 x 25 | 0.92 | 25 x 25 | 0.92 | | |
| 120 | 127 | 20 x 35 | 1.02 | 20 x 35 | 0.99 | 20 x 40 | 0.94 | 30 x 30 | 1.00 |
| | | 22 x 30 | 1.04 | 22 x 30 | 1.01 | 22 x 35 | 1.02 | | |
| | | 25 x 25 | 1.08 | 25 x 25 | 1.03 | 25 x 30 | 1.04 | 35 x 25 | 1.00 |
| | | | | | | 30 x 25 | 1.07 | | |
| 150 | 157 | 20 x 40 | 1.16 | 20 x 45 | 1.15 | 22 x 40 | 1.12 | | |
| | | | | 22 x 35 | 1.19 | | | | |
| | | 22 x 35 | 1.18 | 25 x 30 | 1.19 | 25 x 35 | 1.19 | 30 x 35 | 1.20 |
| | | 25 x 30 | 1.21 | 30 x 25 | 1.14 | 30 x 30 | 1.23 | | |
| 180 | 187 | 22 x 40 | 1.34 | 22 x 45 | 1.36 | 22 x 50 | 1.26 | 30 x 40 | 1.40 |
| | | 25 x 35 | 1.37 | 25 x 35 | 1.37 | 25 x 40 | 1.33 | | |
| | | 30 x 25 | 1.45 | 30 x 25 | 1.35 | 30 x 30 | 1.38 | 35 x 30 | 1.30 |
| 220 | 227 | 22 x 45 | 1.50 | 22 x 50 | 1.69 | 25 x 45 | 1.51 | 30 x 45 | 1.60 |
| | | 25 x 35 | 1.56 | 25 x 40 | 1.58 | 30 x 35 | 1.56 | | |
| | | 30 x 30 | 1.58 | 30 x 30 | 1.56 | 35 x 30 | 1.58 | 35 x 35 | 1.50 |
| 270 | 277 | 25 x 40 | 1.70 | 25 x 45 | 1.83 | 25 x 50 | 1.65 | 30 x 50 | 1.80 |
| | | | | 30 x 35 | 1.72 | 30 x 40 | 1.80 | | |
| | | 30 x 35 | 1.73 | 35 x 30 | 1.76 | 35 x 35 | 1.81 | 35 x 40 | 1.70 |
| 330 | 337 | 25 x 50 | 1.90 | 25 x 50 | 2.18 | 30 x 45 | 2.02 | | |
| | | 30 x 40 | 1.95 | 30 x 40 | 1.98 | | | 35 x 45 | 2.00 |
| | | 35 x 30 | 1.95 | 35 x 35 | 2.04 | 35 x 35 | 2.05 | | |
| 390 | 397 | 30 x 40 | 2.15 | 30 x 45 | 2.34 | 30 x 50 | 2.24 | 35 x 50 | 2.30 |
| | | 35 x 35 | 2.17 | 35 x 35 | 2.26 | 35 x 40 | 2.27 | | |
| 470 | 477 | 30 x 50 | 2.39 | 30 x 50 | 2.67 | 35 x 45 | 2.55 | | |
| | | 35 x 40 | 2.42 | 35 x 40 | 2.60 | | | | |
| 560 | 567 | 35 x 45 | 2.71 | 35 x 45 | 2.93 | | | | |
| 680 | 687 | 35 x 50 | 2.95 | | | | | | |

Maximum Allowable Ripple Current (Arms) at 85°C 120Hz

Case Size Φ D x L (mm)

FEATURES

- High ripple current and high reliability.
- Low equivalent series resistance ESR.
- Different case sizes available for each capacitance value.
- Load life with ripple current: 5,000 hours.



SPECIFICATIONS

| Item | Performance Characteristics | | | | | |
|---------------------------------|---|---|------|--------------|--|---------|
| Operating Temperature Range | -40 to +85°C | | | -25 to +85°C | | |
| Rated Working Voltage Range | 160 to 250V | | | 385 to 450V | | |
| Nominal Capacitance Range | 47 to 2200μF | | | | | |
| Capacitance Tolerance | ±20% at 120Hz, +20°C | | | | | |
| Leakage Current | $I \leq 3\sqrt{CV}$ (μA) after 5 minutes application of rated working voltage at +20°C | | | | | |
| tan δ (120Hz, +20°C) | Working Voltage (V) | 160~420 | 450 | | | |
| | tan δ (max.) | 0.15 | 0.20 | | | |
| Low Temperature Characteristics | Impedance ratio max. at 120Hz | | | | | |
| | Working Voltage (V) | 160 | 200 | 250 | 385 | 400~450 |
| | Z-25°C / Z+20°C | 3 | 3 | 3 | 5 | 8 |
| | Z-40°C / Z+20°C | 15 | - | - | - | - |
| High Temperature Loading | Test time | : 5,000 hours | | | Post test requirements at +20°C | |
| | Test temperature | : +85°C | | | Leakage current : ≤Initial specified value | |
| | Test conditions | : Rated DC working voltage with rated ripple current | | | Cap. change : within ±20% of the initial measured value | |
| | | | | | tan δ : ≤200% of the initial specified value | |
| Shelf Life | At +85°C no voltage applied after 1,000 hours and then being stabilized at +20°C the capacitors shall meet the following limits | | | | | |
| | Leakage current | : ≤Initial specified value | | | | |
| | Cap. change | : within ±15% of the initial measured value | | | | |
| | tan δ | : ≤150% of the initial specified value | | | | |
| Industrial Standard | JIS C - 5101-4 (IEC 60384-4) | | | | | |

RIPPLE CURRENT MULTIPLIER

Frequency Coefficient

| Coefficient | Freq. (Hz) | 60 | 120 | 1k | 10k~50k |
|-------------|------------|------|------|------|---------|
| | | | | | |
| | 160~250V | 0.80 | 1.00 | 1.15 | 1.47 |
| | 385~450V | 0.80 | 1.00 | 1.15 | 1.47 |

PART NUMBER SYSTEM (EXAMPLE : 400V 330μF)

| | | | | | | | |
|---|-----|-------|---|-----|----|-------|-------|
| 1 | 2 3 | 4 5 6 | 7 | 8 9 | 10 | 11 12 | 13 14 |
| E | DP | 337 | M | 2G | P | 45 | SW |



STANDARD RATINGS

| Voltage (Code) | | 160V (2C) | | | 200V (2D) | | | 250V (2E) | | |
|----------------|------|-----------|-----------|----------------|-----------|-----------|----------------|-----------|-----------|----------------|
| Cap. (μF) | Code | Case Size | Impedance | Ripple Current | Case Size | Impedance | Ripple Current | Case Size | Impedance | Ripple Current |
| 150 | 157 | | | | | | | 22 x 25 | 800 | 0.91 |
| 220 | 227 | 22 x 25 | 730 | 1.10 | 22 x 25 | 490 | 1.10 | 22 x 30 | 500 | 1.20 |
| | | | | | | | | 25 x 25 | 490 | 1.20 |
| 330 | 337 | 22 x 30 | 490 | 1.40 | 22 x 30 | 330 | 1.40 | 22 x 40 | 330 | 1.60 |
| | | | | | 25 x 25 | 330 | 1.50 | 25 x 30 | 330 | 1.60 |
| 470 | 477 | 22 x 35 | 350 | 1.80 | 22 x 40 | 240 | 1.90 | 25 x 40 | 240 | 2.10 |
| | | | | | 30 x 25 | 350 | 1.90 | 30 x 30 | 240 | 2.00 |
| 680 | 687 | 25 x 35 | 240 | 2.40 | 25 x 40 | 160 | 2.50 | 30 x 40 | 160 | 2.70 |
| | | | | | 30 x 30 | 160 | 2.40 | | | |
| 1000 | 108 | 30 x 35 | 160 | 3.10 | 30 x 40 | 120 | 3.30 | 35 x 40 | 120 | 3.60 |
| | | | | | 35 x 35 | 120 | 3.50 | | | |
| 1500 | 158 | 30 x 45 | 120 | 4.20 | 35 x 45 | 80 | 4.60 | | | |
| 2200 | 228 | 35 x 50 | 80 | 5.80 | | | | | | |

Maximum Allowable Ripple Current (Arms) at 85°C 120Hz

Case Size Φ D x L (mm)

Maximum Impedance (mΩ) at 20°C 20kHz

| Voltage (Code) | | 385V (2Y) | | | 400V (2G) | | | 420V (2M) | | |
|----------------|------|-----------|-----------|----------------|-----------|-----------|----------------|-----------|-----------|----------------|
| Cap. (μF) | Code | Case Size | Impedance | Ripple Current | Case Size | Impedance | Ripple Current | Case Size | Impedance | Ripple Current |
| 68 | 686 | 22 x 25 | 1570 | 0.61 | 22 x 25 | 1570 | 0.61 | | | |
| 100 | 107 | 22 x 30 | 1070 | 0.79 | 22 x 30 | 1070 | 0.79 | 22 x 30 | 1600 | 0.79 |
| | | 25 x 25 | 1070 | 0.80 | 25 x 25 | 1070 | 0.80 | 25 x 25 | 1600 | 0.80 |
| 120 | 127 | | | | 22 x 35 | 890 | 0.92 | 22 x 30 | 1330 | 0.94 |
| 150 | 157 | 22 x 40 | 720 | 1.10 | 22 x 40 | 720 | 1.10 | 22 x 40 | 1070 | 1.08 |
| | | 25 x 30 | 720 | 1.00 | 30 x 25 | 720 | 1.10 | 25 x 35 | 1070 | 1.11 |
| 180 | 187 | | | | 30 x 30 | 600 | 1.20 | 25 x 35 | 890 | 1.21 |
| | | | | | | | | 30 x 30 | 890 | 1.26 |
| 220 | 227 | 25 x 40 | 490 | 1.40 | 25 x 40 | 490 | 1.40 | 25 x 40 | 730 | 1.41 |
| | | 30 x 30 | 490 | 1.40 | 30 x 35 | 490 | 1.50 | 30 x 35 | 730 | 1.46 |
| 270 | 277 | | | | 30 x 35 | 400 | 1.60 | 30 x 35 | 590 | 1.62 |
| | | | | | | | | 35 x 30 | 590 | 1.71 |
| 330 | 337 | 30 x 40 | 330 | 1.90 | 30 x 45 | 330 | 2.00 | 30 x 45 | 490 | 1.96 |
| | | | | | | | | 35 x 35 | 490 | 1.98 |
| 390 | 397 | | | | 30 x 50 | 280 | 2.20 | 30 x 50 | 410 | 2.22 |
| 470 | 477 | 35 x 40 | 240 | 2.50 | 35 x 45 | 240 | 2.60 | 35 x 45 | 340 | 2.58 |
| 560 | 567 | 35 x 45 | 200 | 2.80 | 35 x 50 | 200 | 2.90 | 35 x 50 | 290 | 2.93 |

Maximum Allowable Ripple Current (Arms) at 85°C 120Hz

Case Size Φ D x L (mm)

Maximum Impedance (mΩ) at 20°C 20kHz

| Voltage (Code) | | 450V (2W) | | |
|----------------|------|-----------|-----------|----------------|
| Cap. (μF) | Code | Case Size | Impedance | Ripple Current |
| 47 | 476 | 22 x 25 | 3400 | 0.51 |
| 68 | 686 | 22 x 30 | 2350 | 0.65 |
| | | 25 x 25 | 2350 | 0.66 |
| 100 | 107 | 22 x 40 | 1600 | 0.88 |
| | | 25 x 30 | 1600 | 0.86 |
| | | 30 x 25 | 1600 | 0.90 |
| 150 | 157 | 25 x 40 | 1070 | 1.20 |
| | | 30 x 30 | 1070 | 1.10 |
| 180 | 187 | 30 x 35 | 890 | 1.30 |
| 220 | 227 | 30 x 40 | 730 | 1.50 |
| 270 | 277 | 30 x 45 | 600 | 1.80 |
| 330 | 337 | 35 x 40 | 490 | 2.10 |
| 470 | 477 | 35 x 50 | 350 | 2.70 |

Maximum Allowable Ripple Current (Arms) at 85°C 120Hz

Case Size Φ D x L (mm)

Maximum Impedance (mΩ) at 20°C 20kHz

Specifications are subject to change without notice. Should a safety or technical concern arise regarding the product, please be sure to contact our sales offices or agents immediately.

FEATURES

- Directly mountable on printed circuit board without holders.
- Terminal spacing fixed at 10mm for PC board plug in.
- Aluminum case designed with explosion-proof vent.
- Load life: 10,000 hours.

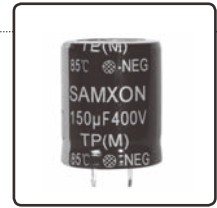

SPECIFICATIONS

| Item | Performance Characteristics | | |
|---------------------------------|---|--|---|
| Operating Temperature Range | -25 to +85°C | | |
| Rated Working Voltage Range | 200 to 450V | | |
| Nominal Capacitance Range | 56 to 2200µF | | |
| Capacitance Tolerance | ±20% at 120Hz, +20°C | | |
| Leakage Current | $I \leq 3\sqrt{CV}$ (µA) after 5 minutes application of rated working voltage at +20°C | | |
| tan δ (120Hz, +20°C) | Working Voltage (V) | 200~250 | 400~450 |
| | tan δ (max.) | 0.15 | 0.15 |
| Low Temperature Characteristics | Impedance ratio max. at 120Hz | | |
| | Working Voltage (V) | 200~250 | 400~450 |
| | Z-25°C / Z+20°C | 3 | 8 |
| High Temperature Loading | Test time | : 10,000 hours | |
| | Test temperature | : +85°C | |
| | Test conditions | : Rated DC working voltage with rated ripple current | |
| | | Post test requirements at +20°C | Leakage current : ≤Initial specified value Cap. change : within ±30% of the initial measured value tan δ : ≤300% of the initial specified value |
| Shelf Life | At +85°C no voltage applied after 1,000 hours and then being stabilized at +20°C the capacitors shall meet the following limits | | |
| | Leakage current | : ≤Initial specified value | |
| | Cap. change | : within ±15% of the initial measured value | |
| | tan δ | : ≤150% of the initial specified value | |
| Industrial Standard | JIS C - 5101-4 (IEC 60384-4) | | |

RIPPLE CURRENT MULTIPLIER

Frequency Coefficient

| Coefficient | Freq. (Hz) | Rated Voltage | | | |
|---------------|------------|---------------|------|------|---------|
| | | 60 | 120 | 1k | 10k~50k |
| Rated Voltage | 200~250V | 0.80 | 1.00 | 1.15 | 1.47 |
| | 400~450V | 0.80 | 1.00 | 1.15 | 1.47 |

PART NUMBER SYSTEM (EXAMPLE : 200V 470µF)

| 1 | 2 3 | 4 5 6 | 7 | 8 9 | 10 | 11 12 | 13 14 |
|---|-----|-------|---|-----|----|-------|-------|
| E | TP | 477 | M | 2D | O | 30 | SW |

Type (Terminal Code)
 Case Length (30mm)
 Diameter (25mm)
 Voltage (200V)
 Tolerance (±20%)
 Capacitance (470µF)
 Series
 E-CAP

STANDARD RATINGS

| Voltage (Code) | | 200V (2D) | | 250V (2E) | | 400V (2G) | | 450V (2W) | |
|----------------|------|-----------|----------------|-----------|----------------|-----------|----------------|-----------|----------------|
| Cap. (µF) | Code | Case Size | Ripple Current | Case Size | Ripple Current | Case Size | Ripple Current | Case Size | Ripple Current |
| 56 | 566 | | | | | | | 20 x 25 | 0.58 |
| 68 | 686 | | | | | 20 x 25 | 0.71 | 20 x 30 | 0.67 |
| | | | | | | | | 22 x 25 | 0.68 |
| 82 | 826 | | | | | 20 x 30 | 0.78 | 20 x 35 | 0.76 |
| | | | | | | 22 x 25 | 0.80 | 22 x 30 | 0.82 |
| 100 | 107 | | | | | 20 x 30 | 0.90 | 20 x 35 | 0.84 |
| | | | | | | 22 x 30 | 0.94 | 22 x 35 | 0.90 |
| 120 | 127 | | | | | 20 x 35 | 1.02 | 20 x 40 | 0.94 |
| | | | | | | 22 x 30 | 1.04 | 22 x 35 | 1.02 |
| | | | | | | 25 x 25 | 1.08 | 25 x 30 | 1.04 |
| 150 | 157 | | | | | 20 x 40 | 1.16 | 30 x 25 | 1.07 |
| | | | | | | 22 x 35 | 1.18 | 22 x 40 | 1.12 |
| 180 | 187 | | | 20 x 25 | 1.14 | 25 x 30 | 1.21 | 25 x 35 | 1.19 |
| | | | | | | 22 x 40 | 1.34 | 30 x 30 | 1.23 |
| | | | | | | 25 x 35 | 1.37 | 22 x 50 | 1.26 |
| 220 | 227 | 20 x 25 | 1.13 | 20 x 30 | 1.20 | 30 x 25 | 1.45 | 25 x 40 | 1.33 |
| | | | | 22 x 25 | 1.18 | 22 x 45 | 1.50 | 30 x 30 | 1.38 |
| 270 | 277 | 20 x 30 | 1.32 | 20 x 30 | 1.35 | 25 x 35 | 1.56 | 25 x 45 | 1.51 |
| | | 22 x 25 | 1.30 | 22 x 30 | 1.43 | 30 x 30 | 1.58 | 30 x 35 | 1.56 |
| 330 | 337 | 20 x 30 | 1.49 | 20 x 35 | 1.60 | 25 x 40 | 1.70 | 25 x 50 | 1.65 |
| | | 22 x 25 | 1.44 | 22 x 30 | 1.58 | 30 x 35 | 1.73 | 30 x 40 | 1.80 |
| 390 | 397 | 20 x 35 | 1.66 | 25 x 25 | 1.53 | 35 x 30 | 1.95 | 35 x 35 | 1.81 |
| | | 22 x 30 | 1.65 | 20 x 40 | 1.83 | 30 x 40 | 1.95 | 30 x 45 | 2.02 |
| | | 25 x 25 | 1.63 | 22 x 35 | 1.79 | 35 x 30 | 1.95 | 35 x 35 | 2.05 |
| 470 | 477 | 20 x 40 | 1.93 | 25 x 30 | 1.79 | 35 x 35 | 2.17 | 35 x 40 | 2.24 |
| | | 22 x 35 | 1.88 | 22 x 40 | 2.05 | 30 x 40 | 2.15 | 35 x 40 | 2.27 |
| 560 | 567 | 25 x 30 | 1.86 | 30 x 25 | 1.94 | 35 x 40 | 2.39 | 35 x 45 | 2.27 |
| | | 22 x 40 | 2.08 | 22 x 45 | 2.36 | 35 x 40 | 2.42 | | 2.55 |
| | | 30 x 25 | 2.05 | 25 x 35 | 2.24 | 35 x 45 | 2.71 | | |
| 680 | 687 | 30 x 25 | 2.05 | 30 x 30 | 2.24 | | | | |
| | | 22 x 45 | 2.36 | 25 x 40 | 2.54 | 35 x 50 | 2.95 | | |
| 820 | 827 | 25 x 35 | 2.36 | 30 x 35 | 2.58 | | | | |
| | | 30 x 30 | 2.36 | 30 x 35 | 2.58 | | | | |
| 1000 | 108 | 22 x 50 | 2.68 | 25 x 50 | 2.87 | | | | |
| | | 25 x 40 | 2.66 | 30 x 35 | 2.84 | | | | |
| | | 30 x 30 | 2.62 | 35 x 30 | 2.82 | | | | |
| 1200 | 128 | 25 x 45 | 3.12 | 30 x 45 | 3.39 | | | | |
| | | 30 x 35 | 3.00 | 35 x 35 | 3.31 | | | | |
| | | 35 x 30 | 2.96 | 35 x 35 | 3.31 | | | | |
| 1500 | 158 | 25 x 50 | 3.44 | 30 x 50 | 3.80 | | | | |
| | | 30 x 40 | 3.44 | 35 x 40 | 3.66 | | | | |
| 1800 | 188 | 35 x 35 | 3.40 | 35 x 40 | 3.66 | | | | |
| | | 30 x 50 | 3.93 | 35 x 45 | 4.12 | | | | |
| 2200 | 228 | 35 x 40 | 3.87 | | | | | | |
| | | 35 x 45 | 4.37 | 35 x 50 | 4.31 | | | | |
| | | 35 x 50 | 5.00 | | | | | | |

Maximum Allowable Ripple Current (Arms) at 85°C 120Hz

Case Size $\Phi D \times L$ (mm)

Specifications are subject to change without notice. Should a safety or technical concern arise regarding the product, please be sure to contact our sales offices or agents immediately.



FEATURES

- Highly reliable capacitors that withstand under high ripple current.
- Two or three dimensions with same ratings.
- Aluminum case designed explosion-proof vent.
- Best for switching power supplies.

SPECIFICATIONS

| Item | Performance Characteristics | |
|---|---|---|
| Operating Temperature Range | -40 to +105°C | -25 to +105°C |
| Rated Working Voltage Range | 10 to 100V | 160 to 500V |
| Nominal Capacitance Range | 47 to 56000µF | |
| Capacitance Tolerance | ±20% at 120Hz, +20°C | |
| Leakage Current | I ≤ 3√CV (µA) after 5 minutes application of rated working voltage at +20°C | |
| tan δ (120Hz, +20°C) | Working Voltage (V) | 10 16 25 35 50 63 80 100 |
| | tan δ (max.) | 0.55 0.50 0.45 0.35 0.30 0.30 0.25 0.20 |
| | Working Voltage (V) | 160~220 250 315~385 400~500 |
| | tan δ (max.) | 0.15 0.15 0.15 0.20 |
| | For capacitance value >33000µF, add following calculated value: $\frac{(\text{rated capacitance}) - 33000\mu\text{F}}{10000\mu\text{F}} \times 0.1$ | |
| Low Temperature Characteristics | Impedance ratio max. at 120Hz | |
| | Working Voltage (V) | 10 16 25 35 50 63 80 100 |
| | Z-25°C / Z+20°C | 6 6 6 6 4 3 3 3 |
| | Z-40°C / Z+20°C | 15 15 15 15 15 15 15 15 |
| High Temperature Loading | Working Voltage (V) | 160~180 200~220 250 315~385 400 450 500 |
| | Z-25°C / Z+20°C | 8 8 8 8 8 8 8 |
| | Test time : 2,000 hours | Post test requirements at +20°C |
| | Test temperature : +105°C | Leakage current : ≤Initial specified value |
| Shelf Life | Test conditions : Rated DC working voltage with rated ripple current | Cap. change : within ±20% of the initial measured value |
| | | tan δ : ≤200% of the initial specified value |
| | At +105°C no voltage applied after 1,000 hours and then being stabilized at +20°C the capacitors shall meet the following limits | |
| Leakage current : ≤Initial specified value | | |
| Cap. change : within ±15% of the initial measured value | | |
| tan δ : ≤150% of the initial specified value | | |
| Industrial Standard | JIS C - 5101-4 (IEC 60384-4) | |

RIPPLE CURRENT MULTIPLIER

Frequency Coefficient

| Coefficient | 60 | 120 | 1k | 10k~50k |
|-------------|------|------|------|---------|
| 10~100V | 0.90 | 1.00 | 1.15 | 1.25 |
| 160~250V | 0.80 | 1.00 | 1.25 | 1.47 |
| 315~500V | 0.80 | 1.00 | 1.30 | 1.47 |

PART NUMBER SYSTEM (EXAMPLE : 350V 220µF)

| | | | | | | | |
|---|-----|-------|---|-----|----|-------|-------|
| 1 | 2 3 | 4 5 6 | 7 | 8 9 | 10 | 11 12 | 13 14 |
| E | HP | 227 | M | 2V | O | 35 | SW |

Type (Terminal Code)
Case Length (35mm)
Diameter (25mm)
Voltage (350V)
Tolerance (±20%)
Capacitance (220µF)
Series
E-CAP

STANDARD RATINGS

| Voltage (Code) | | 10V (1A) | | 16V (1C) | | 25V (1E) | | 35V (1V) | |
|----------------|------|-----------|----------------|-----------|----------------|-----------|----------------|-----------|----------------|
| Cap. (µF) | Code | Case Size | Ripple Current | Case Size | Ripple Current | Case Size | Ripple Current | Case Size | Ripple Current |
| 2700 | 278 | | | | | | | 20 x 25 | 1.62 |
| 3300 | 338 | | | | | | | 20 x 30 | 1.94 |
| | | | | | | | | 22 x 25 | 1.90 |
| 3900 | 398 | | | | | 20 x 25 | 1.72 | 20 x 35 | 2.02 |
| | | | | | | | | 22 x 30 | 2.00 |
| 4700 | 478 | | | | | 20 x 30 | 2.04 | 20 x 40 | 2.21 |
| | | | | | | 22 x 25 | 2.00 | 22 x 35 | 2.20 |
| | | | | | | | | 25 x 25 | 2.20 |
| 5600 | 568 | | | 20 x 25 | 1.89 | 20 x 35 | 2.23 | 22 x 35 | 2.40 |
| | | | | | | 22 x 30 | 2.20 | 25 x 30 | 2.40 |
| 6800 | 688 | 20 x 25 | 1.41 | 20 x 30 | 2.25 | 20 x 40 | 2.72 | 22 x 40 | 2.60 |
| | | | | 22 x 25 | 2.20 | 22 x 30 | 2.40 | 25 x 35 | 2.78 |
| | | | | | | 25 x 25 | 2.40 | 30 x 25 | 2.78 |
| 8200 | 828 | 20 x 30 | 1.67 | 20 x 35 | 2.43 | 22 x 35 | 2.70 | 22 x 50 | 2.90 |
| | | | | 22 x 30 | 2.40 | 25 x 30 | 2.70 | 25 x 40 | 2.90 |
| | | | | | | 30 x 25 | 2.70 | 30 x 30 | 2.90 |
| 10000 | 109 | 20 x 30 | 1.88 | 20 x 40 | 2.79 | 22 x 40 | 3.00 | 25 x 45 | 3.20 |
| | | | | 22 x 30 | 2.60 | 25 x 35 | 3.00 | | |
| | | 22 x 25 | 1.80 | 25 x 25 | 2.60 | 30 x 30 | 3.00 | 30 x 35 | 3.20 |
| 12000 | 129 | 20 x 35 | 2.23 | 22 x 35 | 2.90 | 22 x 50 | 3.20 | 25 x 50 | 3.50 |
| | | 22 x 30 | 2.20 | 25 x 30 | 2.90 | 25 x 40 | 3.20 | 30 x 40 | 3.50 |
| | | 25 x 25 | 2.20 | 30 x 25 | 2.90 | 30 x 30 | 3.20 | 35 x 30 | 3.50 |
| 15000 | 159 | 20 x 40 | 2.31 | 22 x 40 | 3.20 | 25 x 45 | 3.60 | 30 x 45 | 3.90 |
| | | 22 x 35 | 2.30 | 25 x 35 | 3.20 | 30 x 35 | 3.60 | 35 x 35 | 3.90 |
| | | 25 x 25 | 2.30 | 30 x 30 | 3.20 | 35 x 30 | 3.60 | | |
| | | 22 x 40 | 2.52 | 22 x 45 | 3.50 | 30 x 40 | 3.90 | | |
| 18000 | 189 | 25 x 30 | 2.40 | 25 x 40 | 3.50 | | | 35 x 40 | 4.51 |
| | | 30 x 25 | 2.49 | 30 x 30 | 3.50 | 35 x 35 | 3.90 | | |
| 22000 | 229 | 22 x 45 | 2.60 | 25 x 45 | 3.80 | 30 x 45 | 4.30 | | |
| | | 25 x 35 | 2.60 | 30 x 35 | 3.80 | | | 35 x 45 | 5.24 |
| | | 30 x 25 | 2.60 | 35 x 30 | 3.80 | 35 x 35 | 4.30 | | |
| 27000 | 279 | 22 x 50 | 3.19 | 25 x 50 | 4.20 | | | | |
| | | 25 x 40 | 3.10 | 30 x 40 | 4.20 | 35 x 45 | 4.80 | | |
| | | 30 x 30 | 3.10 | 35 x 30 | 4.20 | | | | |
| 33000 | 339 | 25 x 45 | 3.40 | 30 x 45 | 4.70 | | | | |
| | | 30 x 35 | 3.40 | 35 x 35 | 4.70 | 35 x 50 | 5.55 | | |
| | | 35 x 30 | 3.40 | | | | | | |
| 39000 | 399 | 30 x 40 | 3.79 | 30 x 50 | 5.10 | | | | |
| | | 35 x 30 | 3.70 | 35 x 40 | 5.10 | | | | |
| 47000 | 479 | 30 x 45 | 4.26 | 35 x 45 | 5.50 | | | | |
| | | 35 x 35 | 4.20 | | | | | | |
| 56000 | 569 | 35 x 40 | 5.00 | | | | | | |

Maximum Allowable Ripple Current (Arms) at 105°C 120Hz

Case Size Φ D x L (mm)

STANDARD RATINGS

| Voltage (Code) | | 50V (1H) | | 63V (1J) | | 80V (1K) | | 100V (2A) | |
|----------------|------|-----------|----------------|-----------|----------------|-----------|----------------|-----------|----------------|
| Cap. (µF) | Code | Case Size | Ripple Current | Case Size | Ripple Current | Case Size | Ripple Current | Case Size | Ripple Current |
| 560 | 567 | | | | | | | 20 x 25 | 0.95 |
| 680 | 687 | | | | | | | 20 x 30 | 1.15 |
| | | | | | | | | 22 x 25 | 1.09 |
| 820 | 827 | | | | | 20 x 25 | 1.04 | 20 x 35 | 1.31 |
| | | | | | | | | 22 x 30 | 1.40 |
| 1000 | 108 | | | 20 x 25 | 1.21 | 20 x 30 | 1.24 | 20 x 35 | 1.43 |
| | | | | | | 22 x 25 | 1.19 | 22 x 30 | 1.47 |
| | | | | | | | | 25 x 25 | 1.45 |
| 1200 | 128 | | | 20 x 30 | 1.43 | 20 x 35 | 1.43 | 20 x 40 | 1.61 |
| | | | | 22 x 25 | 1.40 | 22 x 30 | 1.50 | 22 x 35 | 1.69 |
| | | | | | | | | 25 x 30 | 1.68 |
| 1500 | 158 | 20 x 25 | 1.29 | 20 x 35 | 1.52 | 20 x 35 | 1.57 | 22 x 40 | 1.97 |
| | | | | 22 x 30 | 1.50 | 22 x 30 | 1.59 | 25 x 35 | 1.98 |
| | | | | | | 25 x 25 | 1.59 | 30 x 25 | 1.95 |
| 1800 | 188 | 20 x 30 | 1.53 | 20 x 35 | 1.72 | 20 x 40 | 1.77 | 22 x 45 | 2.23 |
| | | 22 x 25 | 1.50 | 22 x 30 | 1.70 | 22 x 35 | 1.79 | 25 x 40 | 2.20 |
| | | | | 25 x 25 | 1.70 | 25 x 30 | 1.71 | 30 x 30 | 2.20 |
| 2200 | 228 | 20 x 35 | 1.72 | 20 x 40 | 2.01 | 22 x 40 | 2.03 | 25 x 45 | 2.53 |
| | | | | 22 x 30 | 1.87 | 25 x 35 | 2.10 | 30 x 35 | 2.55 |
| | | 22 x 30 | 1.70 | 25 x 30 | 2.00 | 30 x 25 | 1.98 | 35 x 30 | 2.60 |
| 2700 | 278 | 20 x 35 | 1.82 | 22 x 40 | 2.20 | 22 x 45 | 2.39 | 25 x 50 | 2.82 |
| | | 22 x 30 | 1.80 | 25 x 35 | 2.20 | 25 x 40 | 2.35 | 30 x 40 | 2.86 |
| | | 25 x 25 | 1.80 | 30 x 25 | 2.20 | 30 x 30 | 2.35 | 35 x 35 | 2.90 |
| 3300 | 338 | 20 x 40 | 2.01 | 22 x 45 | 2.60 | 25 x 45 | 2.64 | 30 x 45 | 3.30 |
| | | 22 x 35 | 2.00 | 25 x 35 | 2.39 | 30 x 35 | 2.61 | | |
| | | 25 x 30 | 2.00 | 30 x 30 | 2.50 | 35 x 30 | 2.60 | 35 x 35 | 3.25 |
| | | 22 x 40 | 2.23 | 25 x 40 | 2.57 | 25 x 25 | 2.92 | 30 x 50 | 3.60 |
| 3900 | 398 | 25 x 30 | 2.20 | | | 30 x 40 | 2.82 | | |
| | | 30 x 25 | 2.20 | 30 x 35 | 2.70 | 35 x 30 | 2.97 | 35 x 40 | 3.67 |
| | | 22 x 45 | 2.50 | 25 x 50 | 3.00 | 30 x 45 | 3.34 | | |
| 4700 | 478 | 25 x 35 | 2.43 | 30 x 40 | 3.00 | | | 35 x 45 | 3.80 |
| | | 30 x 30 | 2.50 | 35 x 30 | 3.00 | 35 x 35 | 3.38 | | |
| 5600 | 568 | 22 x 50 | 2.80 | 30 x 40 | 3.22 | 30 x 50 | 3.80 | | |
| | | 25 x 40 | 2.80 | | | | | 35 x 50 | 4.05 |
| | | 30 x 30 | 2.76 | 35 x 35 | 3.30 | 35 x 40 | 3.80 | | |
| 6800 | 688 | 25 x 45 | 3.30 | 30 x 50 | 3.86 | | | | |
| | | 30 x 35 | 3.30 | | | 35 x 45 | 3.90 | | |
| | | 35 x 30 | 3.30 | 35 x 40 | 3.84 | | | | |
| 8200 | 828 | 30 x 40 | 3.71 | 35 x 45 | 4.43 | 35 x 50 | 4.20 | | |
| | | 35 x 35 | 3.85 | | | | | | |
| 10000 | 109 | 30 x 45 | 4.30 | 35 x 50 | 5.11 | | | | |
| | | 35 x 40 | 4.49 | | | | | | |
| 12000 | 129 | 35 x 45 | 4.56 | | | | | | |
| 15000 | 159 | 35 x 50 | 4.80 | | | | | | |

Maximum Allowable Ripple Current (Arms) at 105°C 120Hz

Case Size Φ D x L (mm)

Specifications are subject to change without notice. Should a safety or technical concern arise regarding the product, please be sure to contact our sales offices or agents immediately.

STANDARD RATINGS

| Voltage (Code) | | 160V (2C) | | 180V (2P) | | 200V (2D) | | 220V (2N) | |
|----------------|------|-------------------------------|----------------------|-------------------------------|----------------------|-------------------------------|----------------------|--|------------------------------|
| Cap. (µF) | Code | Case Size | Ripple Current | Case Size | Ripple Current | Case Size | Ripple Current | Case Size | Ripple Current |
| 180 | 187 | | | | | | | 20 x 25 | 0.90 |
| 220 | 227 | | | 20 x 25 | 1.00 | 20 x 25 | 1.00 | 20 x 30 22 x 25 | 1.00 1.00 |
| 270 | 277 | 20 x 25 | 1.10 | 20 x 30 22 x 25 | 1.10 1.00 | 20 x 30 22 x 25 | 1.10 1.10 | 20 x 35 22 x 30 | 1.15 1.15 |
| 330 | 337 | 20 x 30 22 x 25 | 1.20 1.20 | 20 x 30 22 x 25 | 1.20 1.20 | 20 x 35 22 x 30 25 x 25 | 1.20 1.25 1.25 | 20 x 40 22 x 35 25 x 25 | 1.25 1.25 1.25 |
| 390 | 397 | 20 x 35 22 x 30 | 1.42 1.30 | 20 x 35 22 x 30 25 x 25 | 1.30 1.35 1.35 | 20 x 40 22 x 30 25 x 25 | 1.31 1.35 1.35 | 20 x 45 22 x 35 25 x 30 | 1.40 1.40 1.40 |
| 470 | 477 | 20 x 40 22 x 30 25 x 25 | 1.34 1.55 1.55 | 20 x 40 22 x 35 25 x 30 | 1.40 1.50 1.50 | 22 x 35 25 x 30 30 x 25 | 1.50 1.50 1.50 | 25 x 40 25 x 30 30 x 25 | 1.51 1.44 1.50 |
| 560 | 567 | 22 x 35 25 x 30 | 1.67 1.67 | 22 x 40 25 x 30 30 x 25 | 1.67 1.67 1.67 | 22 x 40 25 x 30 30 x 25 | 1.67 1.59 1.67 | 22 x 45 25 x 35 30 x 30 35 x 25 | 1.70 1.64 1.70 1.71 |
| 680 | 687 | 22 x 40 25 x 35 30 x 25 | 1.82 1.85 1.82 | 22 x 45 25 x 35 30 x 30 | 1.78 1.78 1.78 | 22 x 45 25 x 35 30 x 30 | 1.78 1.72 1.78 | 25 x 40 30 x 35 35 x 30 | 1.84 1.93 1.89 |
| 820 | 827 | 22 x 45 25 x 35 30 x 30 | 2.04 2.04 2.04 | 22 x 50 25 x 40 30 x 30 | 2.04 2.04 2.04 | 25 x 40 30 x 35 35 x 25 | 1.99 2.04 2.04 | 25 x 45 30 x 40 35 x 30 | 2.08 2.19 2.16 |
| 1000 | 108 | 25 x 45 30 x 35 | 2.40 2.25 | 25 x 45 30 x 35 35 x 30 | 2.30 2.30 2.30 | 25 x 50 30 x 35 35 x 30 | 2.42 2.30 2.30 | 30 x 45 35 x 35 | 2.50 2.44 |
| 1200 | 128 | 25 x 50 30 x 35 35 x 30 | 2.62 2.49 2.49 | 30 x 40 35 x 35 | 2.55 2.55 | 30 x 40 35 x 35 | 2.65 2.65 | 35 x 40 | 2.79 |
| 1500 | 158 | 30 x 40 35 x 35 | 2.84 2.84 | 30 x 45 35 x 35 | 2.90 2.90 | 35 x 40 | 3.08 | 35 x 45 | 3.22 |
| 1800 | 188 | 30 x 50 35 x 35 | 3.32 3.00 | 35 x 40 | 3.30 | 35 x 45 | 3.48 | | |
| 2200 | 228 | 35 x 45 | 3.50 | 35 x 50 | 3.65 | | | | |

Maximum Allowable Ripple Current (Arms) at 105°C 120Hz

Case Size Φ D x L (mm)

STANDARD RATINGS

| Voltage (Code) | | 250V (2E) | | 315V (2F) | | 350V (2V) | | 385V (2Y) | |
|----------------|------|-------------------------------|----------------------|-------------------------------|----------------------|-------------------------------|----------------------|-------------------------------|----------------------|
| Cap. (μF) | Code | Case Size | Ripple Current | Case Size | Ripple Current | Case Size | Ripple Current | Case Size | Ripple Current |
| 56 | 566 | | | | | | | 20 x 25 | 0.37 |
| 68 | 686 | | | | | 20 x 25 | 0.47 | 20 x 30 22 x 25 | 0.44 0.45 |
| 82 | 826 | | | 20 x 25 | 0.64 | 20 x 30 | 0.54 | 20 x 30 22 x 30 | 0.50 0.52 |
| 100 | 107 | | | 20 x 30 | 0.69 | 20 x 30 22 x 25 | 0.60 0.69 | 20 x 35 20 x 30 25 x 25 | 0.56 0.58 0.57 |
| 120 | 127 | | | 20 x 30 | 0.75 | 20 x 35 | 0.68 | 20 x 40 22 x 30 | 0.66 0.64 |
| | | | | 22 x 25 | 0.75 | 22 x 25 | 0.70 | 25 x 30 22 x 40 | 0.68 0.79 |
| 150 | 157 | 20 x 25 | 0.79 | 20 x 35 22 x 30 25 x 25 | 0.82 0.82 0.82 | 20 x 40 22 x 30 | 0.78 0.77 | 25 x 30 30 x 25 | 0.78 0.75 |
| 180 | 187 | 20 x 30 22 x 25 | 0.90 0.88 | 20 x 40 22 x 30 25 x 25 | 0.90 0.86 0.86 | 22 x 35 25 x 30 30 x 25 | 0.87 0.92 0.90 | 22 x 40 25 x 35 30 x 30 | 0.84 0.86 0.88 |
| 220 | 227 | 20 x 35 | 1.00 | 22 x 35 25 x 30 | 0.98 1.04 | 22 x 40 25 x 35 | 1.00 1.04 | 22 x 45 25 x 35 | 0.96 0.94 |
| | | 22 x 25 | 1.00 | 30 x 25 | 1.04 | 30 x 30 | 1.02 | 30 x 30 | 1.00 |
| 270 | 277 | 20 x 40 22 x 30 25 x 30 | 1.10 1.18 1.27 | 22 x 40 25 x 35 30 x 25 | 1.10 1.16 1.16 | 22 x 45 25 x 40 30 x 30 | 1.11 1.18 1.17 | 25 x 45 30 x 35 35 x 30 | 1.13 1.08 1.10 |
| 330 | 337 | 22 x 35 25 x 30 30 x 25 | 1.30 1.30 1.35 | 22 x 45 25 x 40 30 x 30 | 1.27 1.33 1.33 | 25 x 45 30 x 35 35 x 30 | 1.29 1.34 1.22 | 30 x 45 35 x 30 | 1.31 1.24 |
| 390 | 397 | 22 x 40 25 x 35 30 x 25 | 1.49 1.49 1.49 | 25 x 40 30 x 35 35 x 30 | 1.40 1.47 1.47 | 25 x 50 30 x 35 | 1.51 1.43 | 30 x 45 35 x 35 | 1.41 1.40 |
| 470 | 477 | 22 x 45 25 x 40 30 x 30 | 1.65 1.65 1.65 | 30 x 40 35 x 30 | 1.70 1.70 | 30 x 40 35 x 35 | 1.57 1.69 | 35 x 40 | 1.68 |
| 560 | 567 | 25 x 45 30 x 35 | 1.80 1.80 | 30 x 40 35 x 35 | 1.95 2.05 | 30 x 50 35 x 40 | 1.85 1.90 | 35 x 45 | 1.87 |
| 680 | 687 | 25 x 50 30 x 35 35 x 30 | 2.03 2.00 2.00 | 35 x 40 | 2.17 | 35 x 45 | 2.20 | | |
| 820 | 827 | 30 x 40 35 x 35 | 2.30 2.30 | 35 x 45 | 2.20 | | | | |
| 1000 | 108 | 30 x 50 35 x 40 | 2.70 2.69 | | | | | | |
| 1200 | 128 | 35 x 45 | 3.09 | | | | | | |

Maximum Allowable Ripple Current (Arms) at 105°C 120Hz

Case Size Φ D x L (mm)

Specifications are subject to change without notice. Should a safety or technical concern arise regarding the product, please be sure to contact our sales offices or agents immediately.

STANDARD RATINGS

| Voltage (Code) | | 400V (2G) | | 420V (2M) | | 450V (2W) | | 500V (2H) | |
|----------------|------|-----------|----------------|-----------|----------------|-----------|----------------|-----------|----------------|
| Cap. (µF) | Code | Case Size | Ripple Current | Case Size | Ripple Current | Case Size | Ripple Current | Case Size | Ripple Current |
| 47 | 476 | | | | | 20 x 25 | 0.39 | 22 x 25 | 0.35 |
| 56 | 566 | 20 x 25 | 0.51 | 20 x 25 | 0.51 | 20 x 30 | 0.51 | 22 x 25 | 0.38 |
| | | | | | | 22 x 25 | 0.50 | | |
| 68 | 686 | 20 x 30 | 0.56 | 20 x 30 | 0.56 | 20 x 35 | 0.56 | 22 x 30 | 0.45 |
| | | 22 x 25 | 0.55 | 22 x 25 | 0.55 | 22 x 30 | 0.53 | | |
| | | | | | | 25 x 25 | 0.53 | | |
| 82 | 826 | 20 x 30 | 0.64 | 20 x 35 | 0.64 | 20 x 35 | 0.64 | 22 x 35 | 0.54 |
| | | 22 x 25 | 0.64 | 22 x 25 | 0.64 | 22 x 30 | 0.64 | | |
| | | | | | | 25 x 25 | 0.64 | | |
| 100 | 107 | 20 x 35 | 0.70 | 20 x 35 | 0.70 | 22 x 30 | 0.65 | 22 x 35 | 0.56 |
| | | 22 x 30 | 0.70 | 22 x 30 | 0.70 | 25 x 25 | 0.64 | | |
| | | 25 x 25 | 0.70 | 25 x 25 | 0.70 | 30 x 25 | 0.72 | | |
| 120 | 127 | 20 x 40 | 0.75 | 20 x 40 | 0.75 | 22 x 40 | 0.80 | 22 x 40 | 0.64 |
| | | 22 x 30 | 0.70 | 22 x 30 | 0.70 | 25 x 30 | 0.80 | | |
| | | | | 30 x 25 | 0.78 | 30 x 25 | 0.80 | | |
| 150 | 157 | 22 x 40 | 0.88 | 22 x 40 | 0.88 | 22 x 40 | 0.84 | 25 x 40 | 0.76 |
| | | 25 x 30 | 0.83 | 25 x 35 | 0.88 | 25 x 35 | 0.88 | | |
| | | 30 x 25 | 0.88 | 30 x 25 | 0.88 | 30 x 30 | 0.88 | | |
| 180 | 187 | 22 x 40 | 0.93 | 22 x 40 | 0.90 | 25 x 40 | 1.00 | 30 x 35 | 0.86 |
| | | 25 x 35 | 0.98 | 25 x 35 | 0.92 | | | | |
| | | | | 30 x 30 | 0.96 | 30 x 30 | 1.00 | | |
| | | 30 x 30 | 0.98 | 35 x 25 | 0.94 | | | | |
| 220 | 227 | 22 x 45 | 1.05 | 22 x 45 | 1.05 | 25 x 45 | 1.12 | 30 x 40 | 0.97 |
| | | 25 x 35 | 1.04 | 30 x 30 | 1.03 | 30 x 35 | 1.12 | | |
| | | 30 x 30 | 1.10 | 35 x 25 | 1.10 | 35 x 30 | 1.12 | | |
| 270 | 277 | 25 x 50 | 1.29 | 25 x 50 | 1.37 | 30 x 40 | 1.28 | 30 x 45 | 1.12 |
| | | 30 x 35 | 1.22 | 30 x 35 | 1.18 | | | | |
| | | 35 x 30 | 1.22 | 35 x 30 | 1.22 | 35 x 35 | 1.28 | | |
| 330 | 337 | 30 x 45 | 1.55 | 30 x 45 | 1.49 | 30 x 45 | 1.39 | | |
| | | 35 x 30 | 1.44 | 35 x 30 | 1.36 | 35 x 40 | 1.45 | | |
| 390 | 397 | 30 x 45 | 1.60 | 30 x 45 | 1.60 | 35 x 40 | 1.55 | | |
| | | 35 x 35 | 1.60 | 35 x 40 | 1.66 | | | | |
| 470 | 477 | 35 x 40 | 1.90 | 35 x 40 | 1.81 | 35 x 50 | 1.85 | | |
| 560 | 567 | 35 x 45 | 2.12 | | | | | | |

Maximum Allowable Ripple Current (Arms) at 105°C 120Hz

Case Size ϕ D x L (mm)

FEATURES

- Doesn't spark with DC over voltage.
- Load life: 2,000 hours at 105°C.



SPECIFICATIONS

| Item | Performance Characteristics | | | | |
|---------------------------------|--|---|------|--|------|
| Operating Temperature Range | -25 to +105°C | | | | |
| Rated Working Voltage Range | 200 to 450V | | | | |
| Nominal Capacitance Range | 56 to 1200μF | | | | |
| Capacitance Tolerance | ±20% at 120Hz, +20°C | | | | |
| Leakage Current | $I \leq 3\sqrt{CV}$ (μA) after 5 minutes application of rated working voltage at +20°C | | | | |
| tan δ (120Hz, +20°C) | Working Voltage (V) | 200 | 250 | 400 | 450 |
| | tan δ (max.) | 0.15 | 0.15 | 0.20 | 0.20 |
| Low Temperature Characteristics | Impedance ratio max. at 120Hz | | | | |
| | Rated Voltage (V) | 200 | 250 | 400 | 450 |
| | Z-25°C / Z+20°C | 8 | 8 | 8 | 8 |
| High Temperature Loading | Test time | : 2,000 hours | | Post test requirements at +20°C | |
| | Test temperature | : +105°C | | Leakage current : ≤Initial specified value | |
| | Test conditions | : Rated DC working voltage with rated ripple current | | Cap. change : within ±20% of the initial measured value | |
| | | | | tan δ : ≤200% of the initial specified value | |
| Shelf Life | At +105°C no voltage applied after 1,000 hours and then being stabilized at +20°C the capacitors shall meet the following limits | | | | |
| | Leakage current | : ≤Initial specified value | | | |
| | Cap. change | : within ±15% of the initial measured value | | | |
| | tan δ | : ≤150% of the initial specified value | | | |
| Industrial Standard | JIS C - 5101-4 (IEC 60384-4) | | | | |

RIPPLE CURRENT MULTIPLIER

Frequency Coefficient

| Coefficient Rated Voltage | Freq. (Hz) | 60 | 120 | 1k | 10k~50k |
|------------------------------|------------|----------|------|------|---------|
| | | 200~250V | 0.80 | 1.00 | 1.25 |
| 400~450V | 0.80 | 1.00 | 1.30 | 1.47 | |

PART NUMBER SYSTEM (EXAMPLE : 200V 220μF)

| 1 | 2 3 | 4 5 6 | 7 | 8 9 | 10 | 11 12 | 13 14 |
|---|-----|-------|---|-----|----|-------|-------|
| E | UP | 227 | M | 2D | N | 25 | SW |

Type (Terminal Code)
 Case Length (25mm)
 Diameter (22mm)
 Voltage (200V)
 Tolerance (±20%)
 Capacitance (220μF)
 Series
 E-CAP

STANDARD RATINGS

| Voltage (Code) | | 200V (2D) | | 250V (2E) | | 400V (2G) | | 450V (2W) | |
|----------------|------|-----------|----------------|-----------|----------------|-----------|----------------|-----------|----------------|
| Cap. (μF) | Code | Case Size | Ripple Current | Case Size | Ripple Current | Case Size | Ripple Current | Case Size | Ripple Current |
| 56 | 566 | | | | | 22 x 25 | 0.45 | | |
| 68 | 686 | | | | | 22 x 25 | 0.51 | | |
| 82 | 856 | | | | | 22 x 30 | 0.58 | | |
| 100 | 107 | | | | | 22 x 30 | 0.66 | | |
| 120 | 127 | | | 22 x 25 | 0.68 | 22 x 35 | 0.76 | | |
| | | | | | | 25 x 30 | 0.76 | | |
| 150 | 157 | | | | | 22 x 40 | 0.85 | | |
| | | | | | | 25 x 35 | 0.85 | | |
| | | | | | | 30 x 30 | 0.85 | | |
| 180 | 187 | 22 x 25 | 0.82 | 22 x 30 | 0.87 | 22 x 45 | 0.94 | 30 x 35 | 1.00 |
| | | | | 25 x 25 | 0.93 | 25 x 40 | 0.95 | | |
| | | | | | | 30 x 30 | 0.95 | | |
| 220 | 227 | 22 x 25 | 0.90 | 22 x 30 | 1.00 | 25 x 40 | 1.24 | 30 x 40 | 1.20 |
| | | | | | | 30 x 35 | 1.24 | | |
| | | | | | | 35 x 30 | 1.24 | | |
| 270 | 277 | 22 x 30 | 1.02 | 22 x 35 | 1.14 | 25 x 50 | 1.30 | | |
| | | | | 25 x 30 | 1.13 | 30 x 40 | 1.30 | | |
| | | | | 30 x 25 | 1.25 | 35 x 30 | 1.30 | | |
| 330 | 337 | 22 x 35 | 1.20 | 22 x 40 | 1.28 | 30 x 45 | 1.47 | | |
| | | 25 x 30 | 1.20 | 25 x 35 | 1.29 | 35 x 35 | 1.47 | | |
| 390 | 397 | 22 x 35 | 1.35 | 22 x 45 | 1.42 | | | 35 x 45 | 1.60 |
| | | 25 x 30 | 1.35 | 25 x 40 | 1.46 | | | | |
| | | | | 30 x 30 | 1.52 | | | | |
| 470 | 477 | 22 x 40 | 1.45 | 25 x 45 | 1.64 | | | | |
| | | 25 x 35 | 1.45 | | | | | | |
| | | 30 x 30 | 1.47 | 30 x 35 | 1.67 | | | | |
| 560 | 567 | 22 x 45 | 1.62 | 25 x 50 | 1.82 | | | | |
| | | 25 x 35 | 1.60 | 30 x 40 | 1.87 | | | | |
| | | 30 x 30 | 1.60 | 35 x 30 | 1.99 | | | | |
| | | 25 x 40 | 1.82 | 30 x 45 | 2.12 | | | | |
| 680 | 687 | 30 x 35 | 1.81 | 35 x 35 | 2.19 | | | | |
| | | 35 x 30 | 1.86 | | | | | | |
| 820 | 827 | 25 x 50 | 2.11 | 30 x 50 | 2.39 | | | | |
| | | 30 x 40 | 2.11 | | | | | | |
| | | 35 x 30 | 2.11 | 35 x 40 | 2.42 | | | | |
| 1000 | 108 | 30 x 45 | 2.40 | | | | | | |
| | | 35 x 35 | 2.40 | | | | | | |
| 1200 | 128 | 30 x 50 | 2.69 | | | | | | |
| | | 35 x 40 | 2.65 | | | | | | |

Maximum Allowable Ripple Current (Arms) at 105°C 120Hz

Case Size $\Phi D \times L$ (mm)

DC OVERVOLTAGE TEST CONDITIONS

The vent will operate and the capacitor shall become an open circuit without burning materials when the following test DC voltage is applied.

- Test DC voltage

| Rated voltage | Normal Capacitance | Current Limit | Test Voltage |
|---------------|--------------------|---------------|--------------|
| 200Vdc | <330 | 4A | 300/375Vdc |
| | 330μF ≤ C < 470μF | 5A | |
| | ≥470μF | 7A | |
| 250Vdc | <330μF | 4A | 350/450Vdc |
| | 330μF ≤ C < 470μF | 5A | |
| | <470μF | 7A | |
| 400Vdc | <100μF | 2A | 500/600Vdc |
| | 100μF ≤ C < 220μF | 4A | |
| | ≥220μF | 7A | |
| 450Vdc | <100μF | 2A | 550/675Vdc |
| | 100μF ≤ C < 220μF | 4A | |
| | ≥220μF | 7A | |

• Test circuit



Constant DC voltage/current power supply

Specifications are subject to change without notice. Should a safety or technical concern arise regarding the product, please be sure to contact our sales offices or agents immediately.

FEATURES

- Highly reliable capacitors that withstand under high ripple current.
- Two or three dimensions with same ratings.
- Aluminum case designed explosion-proof vent.
- Best for switching power supplies.
- Load life: 3,000 hours.



SPECIFICATIONS

| Item | Performance Characteristics | |
|---------------------------------|---|---|
| Operating Temperature Range | -40 to +105°C | -25 to +105°C |
| Rated Working Voltage Range | 10 to 100V | 160 to 450V |
| Nominal Capacitance Range | 47 to 56000µF | |
| Capacitance Tolerance | ±20% at 120Hz, +20°C | |
| Leakage Current | $I \leq 3\sqrt{CV}$ (µA) after 5 minutes application of rated working voltage at +20°C | |
| tan δ (120Hz, +20°C) | Working Voltage (V) | 10 16 25 35 50 63 80 100 |
| | tan δ (max.) | 0.55 0.50 0.45 0.40 0.35 0.30 0.25 0.20 |
| | Working Voltage (V) | 160~220 250 315~450 |
| | tan δ (max.) | 0.15 0.15 0.25 |
| | For capacitance value >33000µF, add following calculated value: $\frac{(\text{rated capacitance}) - 33000\mu\text{F}}{10000\mu\text{F}} \times 0.1$ | |
| Low Temperature Characteristics | Impedance ratio max. at 120Hz | |
| | Working Voltage (V) | 10 16 25 35 50 63 80 100 |
| | Z-25°C / Z+20°C | 6 6 6 6 4 3 3 3 |
| | Z-40°C / Z+20°C | 15 15 15 15 15 15 15 15 |
| | Working Voltage (V) | 160 200~220 250 315~385 400~420 450 |
| | Z-25°C / Z+20°C | 8 8 8 8 8 8 |
| High Temperature Loading | Test time | : 3,000 hours |
| | Test temperature | : +105°C |
| | Test conditions | : Rated DC working voltage with rated ripple current |
| | Post test requirements at +20°C | Leakage current : ≤Initial specified value Cap. change : within ±20% of the initial measured value tan δ : ≤200% of the initial specified value |
| Shelf Life | At +105°C no voltage applied after 1,000 hours and then being stabilized at +20°C the capacitors shall meet the following limits | |
| | Leakage current | : ≤Initial specified value |
| | Cap. change | : within ±15% of the initial measured value |
| | tan δ | : ≤150% of the initial specified value |
| Industrial Standard | JIS C - 5101-4 (IEC 60384-4) | |

RIPPLE CURRENT MULTIPLIER

Frequency Coefficient

| Coefficient | Freq. (Hz) | Rated Voltage | | | |
|-------------|------------|---------------|------|------|---------|
| | | 60 | 120 | 1k | 10k~50k |
| 10~100V | | 0.90 | 1.00 | 1.15 | 1.25 |
| 160~250V | | 0.80 | 1.00 | 1.25 | 1.47 |
| 315~450V | | 0.80 | 1.00 | 1.30 | 1.47 |

PART NUMBER SYSTEM (EXAMPLE : 400V 100µF)

| | | | | | | | |
|---|----|-----|---|----|----|------|------|
| 1 | 23 | 456 | 7 | 89 | 10 | 1112 | 1314 |
| E | KP | 107 | M | 2G | O | 25 | S W |

Type (Terminal Code)
 Case Length (25mm)
 Diameter (25mm)
 Voltage (400V)
 Tolerance (±20%)
 Capacitance (100µF)
 Series
 E-CAP

STANDARD RATINGS

| Voltage (Code) | | 10V (1A) | | 16V (1C) | | 25V (1E) | | 35V (1V) | |
|----------------|------|-----------|----------------|-----------|----------------|-----------|----------------|-----------|----------------|
| Cap. (µF) | Code | Case Size | Ripple Current | Case Size | Ripple Current | Case Size | Ripple Current | Case Size | Ripple Current |
| 2700 | 278 | | | | | | | 20 x 25 | 1.62 |
| 3300 | 338 | | | | | | | 20 x 30 | 1.94 |
| | | | | | | | | 22 x 25 | 1.90 |
| 3900 | 398 | | | | | 20 x 25 | 1.72 | 20 x 35 | 2.02 |
| | | | | | | | | 22 x 30 | 2.00 |
| 4700 | 478 | | | | | 20 x 30 | 2.04 | 20 x 40 | 2.21 |
| | | | | | | 22 x 25 | 2.00 | 22 x 35 | 2.20 |
| 5600 | 568 | | | 20 x 25 | 1.89 | 20 x 35 | 2.23 | 22 x 35 | 2.40 |
| | | | | | | 22 x 30 | 2.20 | 25 x 30 | 2.40 |
| 6800 | 688 | 20 x 25 | 1.41 | 20 x 30 | 2.25 | 20 x 40 | 2.72 | 22 x 40 | 2.60 |
| | | | | 22 x 25 | 2.20 | 22 x 30 | 2.40 | 25 x 35 | 2.60 |
| 8200 | 828 | 20 x 30 | 1.67 | 20 x 35 | 2.43 | 22 x 35 | 2.70 | 22 x 50 | 2.90 |
| | | | | 22 x 30 | 2.40 | 25 x 30 | 2.70 | 25 x 40 | 2.90 |
| 10000 | 109 | 20 x 30 | 1.88 | 20 x 40 | 2.79 | 22 x 40 | 3.00 | 25 x 45 | 3.20 |
| | | | | 22 x 30 | 2.60 | 25 x 35 | 3.00 | 30 x 35 | 3.20 |
| 12000 | 129 | 20 x 35 | 2.23 | 22 x 35 | 2.90 | 22 x 50 | 3.20 | 25 x 50 | 3.50 |
| | | | | 22 x 30 | 2.20 | 25 x 40 | 3.20 | 30 x 40 | 3.50 |
| 15000 | 159 | 20 x 40 | 2.31 | 22 x 40 | 3.20 | 25 x 45 | 3.60 | 30 x 45 | 3.90 |
| | | | | 22 x 35 | 2.30 | 30 x 35 | 3.60 | 35 x 35 | 3.90 |
| 18000 | 189 | 25 x 30 | 2.40 | 22 x 45 | 3.50 | 30 x 40 | 3.90 | 35 x 40 | 4.51 |
| | | | | 30 x 25 | 2.49 | 30 x 30 | 3.50 | 35 x 35 | 3.90 |
| 22000 | 229 | 22 x 45 | 2.60 | 25 x 45 | 3.80 | 30 x 45 | 4.30 | 35 x 45 | 5.24 |
| | | | | 25 x 35 | 2.60 | 30 x 30 | 3.80 | | |
| 27000 | 279 | 30 x 25 | 2.60 | 35 x 30 | 3.80 | 35 x 35 | 4.30 | | |
| | | | | 22 x 45 | 3.19 | 25 x 50 | 4.20 | | |
| 33000 | 339 | 25 x 40 | 3.10 | 30 x 35 | 4.20 | 35 x 45 | 4.80 | | |
| | | | | 30 x 30 | 3.10 | 35 x 30 | 4.20 | | |
| 39000 | 399 | 25 x 45 | 3.40 | 30 x 40 | 4.70 | 35 x 50 | 5.55 | | |
| | | | | 30 x 35 | 3.40 | | | 35 x 35 | 4.70 |
| 47000 | 479 | 35 x 30 | 3.70 | 30 x 45 | 4.90 | | | | |
| | | | | 35 x 30 | 3.70 | 35 x 40 | 5.10 | | |
| 56000 | 569 | 30 x 45 | 4.26 | 30 x 50 | 5.27 | | | | |
| | | | | 35 x 35 | 4.20 | 35 x 45 | 5.50 | | |

Maximum Allowable Ripple Current (Arms) at 105°C 120Hz

Case Size Φ D x L (mm)

Specifications are subject to change without notice. Should a safety or technical concern arise regarding the product, please be sure to contact our sales offices or agents immediately.

STANDARD RATINGS

| Voltage (Code) | | 50V (1H) | | 63V (1J) | | 80V (1K) | | 100V (2A) | |
|----------------|------|-----------|----------------|-----------|----------------|-----------|----------------|-----------|----------------|
| Cap. (µF) | Code | Case Size | Ripple Current | Case Size | Ripple Current | Case Size | Ripple Current | Case Size | Ripple Current |
| 560 | 567 | | | | | | | 20 x 25 | 0.95 |
| 680 | 687 | | | | | | | 20 x 30 | 1.15 |
| | | | | | | | | 22 x 25 | 1.09 |
| 820 | 827 | | | | | 20 x 25 | 1.04 | 20 x 35 | 1.31 |
| | | | | | | | | 22 x 30 | 1.40 |
| 1000 | 108 | | | 20 x 25 | 1.21 | 20 x 30 | 1.24 | 20 x 35 | 1.43 |
| | | | | | | 22 x 25 | 1.19 | 22 x 30 | 1.47 |
| | | | | | | | | 25 x 25 | 1.45 |
| 1200 | 128 | | | 20 x 30 | 1.43 | 20 x 35 | 1.43 | 20 x 40 | 1.61 |
| | | | | 22 x 25 | 1.40 | 22 x 30 | 1.50 | 22 x 35 | 1.69 |
| | | | | | | | | 25 x 30 | 1.68 |
| 1500 | 158 | 20 x 25 | 1.29 | 20 x 35 | 1.52 | 20 x 35 | 1.57 | 22 x 40 | 1.97 |
| | | | | 22 x 30 | 1.50 | 22 x 30 | 1.59 | 25 x 35 | 1.98 |
| | | | | | | 25 x 25 | 1.59 | 30 x 25 | 1.95 |
| 1800 | 188 | 20 x 30 | 1.53 | 20 x 35 | 1.72 | 20 x 40 | 1.77 | 22 x 45 | 2.23 |
| | | 22 x 25 | 1.50 | 22 x 30 | 1.70 | 22 x 35 | 1.79 | 25 x 40 | 2.20 |
| | | | | 25 x 25 | 1.70 | 25 x 30 | 1.71 | 30 x 30 | 2.20 |
| 2200 | 228 | 20 x 35 | 1.72 | 20 x 40 | 2.01 | 22 x 40 | 2.03 | 25 x 45 | 2.53 |
| | | 22 x 30 | 1.70 | 22 x 35 | 2.00 | 25 x 35 | 2.10 | 30 x 35 | 2.55 |
| | | | | 25 x 30 | 2.00 | 30 x 25 | 1.98 | 35 x 30 | 2.60 |
| 2700 | 278 | 20 x 35 | 1.82 | 22 x 40 | 2.20 | 22 x 45 | 2.39 | 25 x 50 | 2.82 |
| | | 22 x 30 | 1.80 | 25 x 35 | 2.20 | 25 x 40 | 2.35 | 30 x 40 | 2.86 |
| | | 25 x 25 | 1.80 | 30 x 25 | 2.20 | 30 x 30 | 2.35 | 35 x 35 | 2.90 |
| 3300 | 338 | 20 x 40 | 2.01 | 22 x 45 | 2.60 | 25 x 45 | 2.64 | 30 x 45 | 3.30 |
| | | 22 x 35 | 2.00 | 25 x 35 | 2.39 | 30 x 35 | 2.61 | 35 x 35 | 3.25 |
| | | 25 x 30 | 2.00 | 30 x 30 | 2.50 | 35 x 30 | 2.60 | 35 x 35 | 3.25 |
| 3900 | 398 | 22 x 40 | 2.23 | 25 x 40 | 2.57 | 25 x 50 | 2.92 | 30 x 50 | 3.60 |
| | | 25 x 30 | 2.20 | | | 30 x 40 | 2.82 | | |
| | | 30 x 25 | 2.20 | 30 x 35 | 2.70 | 35 x 30 | 2.97 | 35 x 40 | 3.67 |
| 4700 | 478 | 22 x 45 | 2.50 | 25 x 50 | 3.00 | 30 x 45 | 3.34 | | |
| | | 25 x 35 | 2.43 | 30 x 40 | 3.00 | | | 35 x 45 | 3.80 |
| | | 30 x 30 | 2.50 | 35 x 30 | 3.00 | 35 x 35 | 3.38 | | |
| 5600 | 568 | 22 x 50 | 2.80 | 30 x 40 | 3.22 | 30 x 50 | 3.80 | | |
| | | 25 x 40 | 2.80 | | | | | 35 x 50 | 4.05 |
| | | 30 x 30 | 2.76 | 35 x 35 | 3.30 | 35 x 40 | 3.80 | | |
| 6800 | 688 | 25 x 45 | 3.30 | 30 x 50 | 3.86 | | | | |
| | | 30 x 35 | 3.30 | | | 35 x 45 | 3.90 | | |
| | | 35 x 30 | 3.30 | 35 x 40 | 3.84 | | | | |
| 8200 | 828 | 30 x 40 | 3.71 | | | | | | |
| | | 35 x 35 | 3.85 | 35 x 45 | 4.43 | 35 x 50 | 4.20 | | |
| 10000 | 109 | 30 x 50 | 4.51 | | | | | | |
| | | 35 x 40 | 4.49 | 35 x 50 | 5.11 | | | | |
| 12000 | 129 | 35 x 45 | 4.56 | | | | | | |
| 15000 | 159 | 35 x 50 | 4.80 | | | | | | |

Maximum Allowable Ripple Current (Arms) at 105°C 120Hz

Case Size Φ D x L (mm)

Specifications are subject to change without notice. Should a safety or technical concern arise regarding the product, please be sure to contact our sales offices or agents immediately.

STANDARD RATINGS

| Voltage (Code) | | 160V (2C) | | 180V (2P) | | 200V (2D) | | 220V (2N) | |
|----------------|------|-------------------------------|----------------------|-------------------------------|----------------------|-------------------------------|----------------------|-------------------------------|----------------------|
| Cap. (μF) | Code | Case Size | Ripple Current | Case Size | Ripple Current | Case Size | Ripple Current | Case Size | Ripple Current |
| 180 | 187 | | | | | | | 20 x 25 | 0.90 |
| 220 | 227 | | | 20 x 25 | 1.00 | 20 x 25 | 1.00 | 20 x 30 22 x 25 | 1.00 1.00 |
| 270 | 277 | 20 x 25 | 1.10 | 20 x 30 22 x 25 | 1.10 1.00 | 20 x 30 22 x 25 | 1.10 1.10 | 20 x 35 22 x 30 | 1.15 1.15 |
| 330 | 337 | 20 x 30 22 x 25 | 1.20 1.20 | 20 x 35 22 x 30 | 1.20 1.20 | 20 x 35 22 x 30 25 x 25 | 1.20 1.25 1.25 | 20 x 40 22 x 35 25 x 25 | 1.25 1.25 1.25 |
| 390 | 397 | 20 x 35 22 x 30 | 1.42 1.30 | 20 x 35 22 x 30 25 x 25 | 1.30 1.35 1.35 | 20 x 40 22 x 35 25 x 30 | 1.31 1.35 1.35 | 20 x 45 22 x 35 25 x 25 | 1.40 1.40 1.40 |
| 470 | 477 | 20 x 40 22 x 30 25 x 25 | 1.34 1.55 1.55 | 20 x 40 22 x 35 25 x 30 | 1.40 1.50 1.50 | 22 x 40 25 x 30 30 x 25 | 1.50 1.50 1.50 | 22 x 40 25 x 30 30 x 25 | 1.51 1.44 1.50 |
| 560 | 567 | 22 x 35 25 x 30 | 1.67 1.67 | 22 x 40 25 x 30 30 x 25 | 1.67 1.67 1.67 | 22 x 45 25 x 35 30 x 25 | 1.67 1.70 1.67 | 25 x 35 30 x 30 35 x 25 | 1.64 1.70 1.71 |
| 680 | 687 | 22 x 40 25 x 35 30 x 25 | 1.82 1.85 1.82 | 22 x 45 25 x 35 30 x 30 | 1.78 1.78 1.78 | 22 x 50 25 x 40 30 x 30 | 1.78 1.82 1.78 | 25 x 40 30 x 35 35 x 30 | 1.84 1.93 1.89 |
| 820 | 827 | 22 x 45 25 x 40 30 x 30 | 2.04 2.04 2.04 | 22 x 50 25 x 40 30 x 30 | 2.04 2.04 2.04 | 25 x 45 30 x 35 35 x 30 | 2.10 2.04 2.04 | 25 x 45 30 x 40 35 x 30 | 2.08 2.19 2.16 |
| 1000 | 108 | 25 x 45 30 x 35 | 2.40 2.25 | 25 x 45 30 x 35 35 x 30 | 2.30 2.30 2.30 | 25 x 50 30 x 40 35 x 35 | 2.42 2.30 2.30 | 30 x 45 35 x 35 | 2.50 2.44 |
| 1200 | 128 | 25 x 50 30 x 40 35 x 30 | 2.62 2.49 2.49 | 30 x 40 35 x 35 | 2.55 2.55 | 30 x 45 35 x 35 | 2.65 2.65 | 35 x 40 | 2.79 |
| 1500 | 158 | 30 x 45 35 x 35 | 2.84 2.84 | 30 x 45 35 x 40 | 2.90 2.90 | 35 x 40 | 3.08 | 35 x 45 | 3.22 |
| 1800 | 188 | 30 x 50 35 x 40 | 3.32 3.00 | 35 x 45 | 3.30 | 35 x 45 | 3.48 | | |
| 2200 | 228 | 35 x 45 | 3.50 | 35 x 50 | 3.65 | | | | |

Maximum Allowable Ripple Current (Arms) at 105°C 120Hz

Case Size Φ D x L (mm)

STANDARD RATINGS

| Voltage (Code) | | 250V (2E) | | 315V (2F) | | 350V (2V) | | 385V (2Y) | |
|----------------|------|-------------------------------|----------------------|-------------------------------|----------------------|-------------------------------|----------------------|-------------------------------|----------------------|
| Cap. (μF) | Code | Case Size | Ripple Current | Case Size | Ripple Current | Case Size | Ripple Current | Case Size | Ripple Current |
| 56 | 566 | | | | | | | 20 x 25 | 0.37 |
| 68 | 686 | | | | | 20 x 25 | 0.47 | 20 x 30 22 x 25 | 0.44 0.45 |
| 82 | 826 | | | 20 x 25 | 0.64 | 20 x 30 | 0.54 | 20 x 30 22 x 30 | 0.50 0.52 |
| 100 | 107 | | | 20 x 30 | 0.69 | 20 x 30 22 x 25 | 0.60 0.69 | 20 x 35 22 x 30 25 x 25 | 0.56 0.58 0.57 |
| 120 | 127 | | | 20 x 30 22 x 25 | 0.75 0.75 | 20 x 35 22 x 30 25 x 25 | 0.68 0.75 0.75 | 20 x 40 22 x 35 25 x 30 | 0.66 0.68 0.68 |
| 150 | 157 | 20 x 25 | 0.79 | 20 x 35 22 x 30 25 x 25 | 0.82 0.82 0.82 | 20 x 40 22 x 35 25 x 30 | 0.78 0.82 0.83 | 22 x 40 25 x 30 30 x 25 | 0.79 0.78 0.75 |
| 180 | 187 | 20 x 30 22 x 25 | 0.90 0.88 | 20 x 40 22 x 35 25 x 30 | 0.90 0.92 0.93 | 22 x 40 25 x 30 30 x 25 | 0.92 0.92 0.90 | 22 x 45 25 x 35 30 x 30 | 0.89 0.86 0.88 |
| 220 | 227 | 20 x 35 22 x 30 25 x 25 | 1.00 1.00 1.08 | 22 x 40 25 x 30 30 x 25 | 1.04 1.04 1.04 | 22 x 50 25 x 35 30 x 30 | 1.05 1.04 1.02 | 22 x 50 25 x 40 30 x 30 | 1.01 1.00 1.00 |
| 270 | 277 | 20 x 40 22 x 35 25 x 30 | 1.10 1.18 1.27 | 22 x 45 25 x 35 30 x 25 | 1.16 1.16 1.16 | 22 x 50 25 x 40 30 x 30 | 1.16 1.18 1.17 | 25 x 45 30 x 40 35 x 30 | 1.13 1.14 1.10 |
| 330 | 337 | 22 x 40 25 x 30 30 x 25 | 1.30 1.30 1.35 | 22 x 50 25 x 40 30 x 30 | 1.33 1.33 1.33 | 25 x 45 30 x 35 35 x 30 | 1.29 1.34 1.22 | 30 x 45 35 x 35 | 1.31 1.32 |
| 390 | 397 | 22 x 45 25 x 35 30 x 30 | 1.49 1.49 1.49 | 25 x 45 30 x 35 35 x 30 | 1.47 1.47 1.47 | 25 x 50 30 x 40 35 x 35 | 1.51 1.51 1.47 | 30 x 50 35 x 40 | 1.48 1.48 |
| 470 | 477 | 22 x 50 25 x 40 30 x 30 | 1.65 1.65 1.65 | 30 x 40 35 x 30 | 1.70 1.70 | 30 x 45 35 x 35 | 1.65 1.69 | 35 x 45 | 1.76 |
| 560 | 567 | 25 x 45 30 x 35 25 x 50 | 1.80 1.80 2.03 | 30 x 45 35 x 35 | 2.05 2.05 | 30 x 50 35 x 40 | 1.85 1.90 | 35 x 50 | 1.95 |
| 680 | 687 | 30 x 40 35 x 30 | 2.00 2.00 | 35 x 40 | 2.17 | 35 x 45 | 2.20 | | |
| 820 | 827 | 30 x 45 35 x 35 | 2.30 2.30 | 35 x 45 | 2.20 | | | | |
| 1000 | 108 | 30 x 50 35 x 40 | 2.70 2.69 | | | | | | |
| 1200 | 128 | 35 x 45 | 3.09 | | | | | | |

Maximum Allowable Ripple Current (Arms) at 105°C 120Hz

Case Size Φ D x L (mm)

Specifications are subject to change without notice. Should a safety or technical concern arise regarding the product, please be sure to contact our sales offices or agents immediately.

STANDARD RATINGS

| Voltage (Code) | | 400V (2G) | | 420V (2M) | | 450V (2W) | | | |
|----------------|------|-----------|----------------|-----------|----------------|-----------|----------------|---------|------|
| Cap. (μF) | Code | Case Size | Ripple Current | Case Size | Ripple Current | Case Size | Ripple Current | | |
| 47 | 476 | | | | | 20 x 25 | 0.39 | | |
| 56 | 566 | 20 x 25 | 0.51 | 20 x 25 | 0.51 | 20 x 30 | 0.51 | | |
| | | | | | | 22 x 25 | 0.50 | | |
| 68 | 686 | 20 x 30 | 0.56 | 20 x 30 | 0.56 | 20 x 35 | 0.56 | | |
| | | | | | | 22 x 30 | 0.53 | | |
| | | | | | | 25 x 25 | 0.53 | | |
| 82 | 826 | 20 x 30 | 0.64 | 20 x 35 | 0.64 | 20 x 35 | 0.64 | | |
| | | | | | | 22 x 30 | 0.64 | | |
| | | | | | | 25 x 25 | 0.64 | | |
| 100 | 107 | 20 x 35 | 0.70 | 20 x 35 | 0.70 | 22 x 35 | 0.69 | | |
| | | | | | | 22 x 30 | 0.70 | | |
| | | | | | | 25 x 25 | 0.70 | | |
| 120 | 127 | 20 x 40 | 0.75 | 20 x 40 | 0.75 | 22 x 40 | 0.80 | | |
| | | | | | | 22 x 35 | 0.75 | | |
| | | | | | | 25 x 30 | 0.76 | | |
| 150 | 157 | 22 x 40 | 0.88 | 22 x 40 | 0.88 | 22 x 45 | 0.88 | | |
| | | | | | | 25 x 30 | 0.83 | | |
| | | | | | | 30 x 25 | 0.88 | | |
| 180 | 187 | 22 x 45 | 0.98 | 22 x 45 | 0.95 | 25 x 40 | 1.00 | | |
| | | | | | | | | 25 x 40 | 0.97 |
| | | | | | | 25 x 35 | 0.98 | 30 x 30 | 0.96 |
| 220 | 227 | 30 x 30 | 0.98 | 30 x 30 | 0.94 | 30 x 30 | 1.00 | | |
| | | | | | | | | 22 x 50 | 1.10 |
| | | | | | | | | 25 x 40 | 1.10 |
| 270 | 277 | 30 x 35 | 1.10 | 30 x 35 | 1.10 | 25 x 45 | 1.12 | | |
| | | | | | | 30 x 30 | 1.10 | | |
| | | | | | | 35 x 25 | 1.10 | | |
| 330 | 337 | 25 x 50 | 1.29 | 25 x 50 | 1.37 | 30 x 40 | 1.28 | | |
| | | | | | | 30 x 35 | 1.22 | | |
| | | | | | | 35 x 30 | 1.22 | | |
| 390 | 397 | 30 x 45 | 1.55 | 30 x 45 | 1.49 | 30 x 50 | 1.45 | | |
| | | | | | | 35 x 30 | 1.44 | | |
| 470 | 477 | 30 x 45 | 1.60 | 30 x 50 | 1.67 | 35 x 40 | 1.55 | | |
| | | | | | | | | 35 x 35 | 1.60 |
| 560 | 567 | 35 x 45 | 2.12 | | | | | | |

Maximum Allowable Ripple Current (Arms) at 105°C 120Hz

Case Size ΦD x L (mm)

FEATURES

- High ripple current.
- Two or three dimensions with same ratings.
- Aluminum case designed explosion-proof vent.
- Best for switching power supplies.
- Load life with ripple current : 105°C 5,000 hours.



SPECIFICATIONS

| Item | Performance Characteristics | | | | | | |
|---|--|---|---------|---------------|--|---------|--------|
| Operating Temperature Range | -40 to +105°C | | | -25 to +105°C | | | |
| Rated Working Voltage Range | 10 to 100V | | | 160 to 450V | | | |
| Nominal Capacitance Range | 82 to 47000µF | | | | | | |
| Capacitance Tolerance | ±20% at 120Hz, +20°C | | | | | | |
| Leakage Current | I ≤ 3√CV (µA) after 5 minutes application of rated working voltage at +20°C | | | | | | |
| tan δ (120Hz, +20°C) | Working Voltage (V) | 10 | 16 | 25 | 35 | 50 | 63~100 |
| | tan δ (max.) | 0.60 | 0.45 | 0.30 | 0.25 | 0.20 | 0.15 |
| | Working Voltage (V) | 160~400 | 420~450 | | | | |
| | tan δ (max.) | 0.15 | 0.20 | | | | |
| For capacitance value >33000µF, add following calculated value: $\frac{(\text{rated capacitance}) - 33000\mu\text{F}}{10000\mu\text{F}} \times 0.1$ | | | | | | | |
| Low Temperature Characteristics | Impedance ratio max. at 120Hz | | | | | | |
| | Working Voltage (V) | 10 | 16 | 25 | 35 | 50 | 63~100 |
| | Z-25°C / Z+20°C | 6 | 6 | 6 | 6 | 4 | 3 |
| | Z-40°C / Z+20°C | 15 | 15 | 15 | 15 | 15 | 15 |
| | Working Voltage (V) | 160 | 250 | 315 | 350 | 400~420 | 450 |
| | Z-25°C / Z+20°C | 8 | 8 | 8 | 8 | 8 | 8 |
| High Temperature Loading | Test time | : 5,000 hours | | | Post test requirements at +20°C | | |
| | Test temperature | : +105°C | | | Leakage current : ≤Initial specified value | | |
| | Test conditions | : Rated DC working voltage with rated ripple current | | | Cap. change : within ±20% of the initial measured value | | |
| | | | | | tan δ : ≤200% of the initial specified value | | |
| Shelf Life | At +105°C no voltage applied after 1,000 hours and then being stabilized at +20°C the capacitors shall meet the following limits | | | | | | |
| | Leakage current | : ≤Initial specified value | | | | | |
| | Cap. change | : within ±15% of the initial measured value | | | | | |
| | tan δ | : ≤150% of the initial specified value | | | | | |
| Industrial Standard | JIS C - 5101-4 (IEC 60384-4) | | | | | | |

RIPPLE CURRENT MULTIPLIER

Frequency Coefficient

| Coefficient | Freq. (Hz) | 60 | 120 | 1k | 10k~50k |
|-------------|------------|------|------|------|---------|
| | | | | | |
| | 10~100V | 0.90 | 1.00 | 1.15 | 1.25 |
| | 160~250V | 0.80 | 1.00 | 1.25 | 1.47 |
| | 315~450V | 0.80 | 1.00 | 1.30 | 1.47 |

PART NUMBER SYSTEM (EXAMPLE : 160V 2200µF)

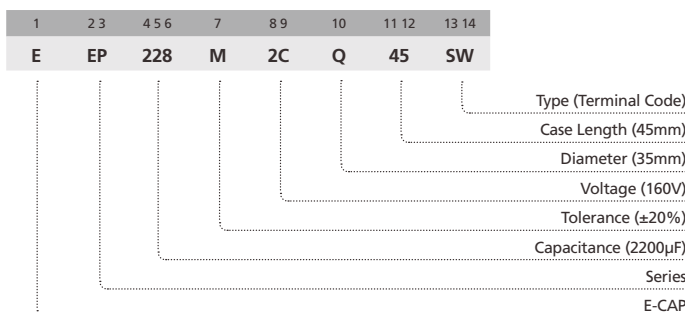

STANDARD RATINGS

| Voltage (Code) | | 10V (1A) | | 16V (1C) | | 25V (1E) | | 35V (1V) | |
|----------------|------|-----------|----------------|-----------|----------------|-----------|----------------|-----------|----------------|
| Cap. (µF) | Code | Case Size | Ripple Current | Case Size | Ripple Current | Case Size | Ripple Current | Case Size | Ripple Current |
| 2200 | 228 | | | | | | | 22 x 25 | 1.10 |
| 3300 | 338 | | | | | | | 22 x 30 | 1.42 |
| | | | | | | | | 25 x 25 | 1.41 |
| 3900 | 398 | | | | | 22 x 25 | 1.31 | 22 x 35 | 1.58 |
| | | | | | | | | 25 x 30 | 1.58 |
| 4700 | 478 | | | | | 22 x 30 | 1.51 | 22 x 40 | 1.78 |
| | | | | | | 25 x 25 | 1.51 | 30 x 25 | 1.77 |
| 5600 | 568 | | | | | | | 25 x 35 | 1.98 |
| | | | | 22 x 25 | 1.44 | 22 x 35 | 1.70 | 30 x 30 | 1.98 |
| | | | | | | | | 35 x 25 | 2.03 |
| 6800 | 688 | 22 x 25 | 1.30 | 22 x 30 | 1.66 | 22 x 40 | 1.92 | 22 x 50 | 2.26 |
| | | | | 25 x 25 | 1.66 | 25 x 30 | 1.87 | 25 x 40 | 2.24 |
| | | | | | | 30 x 25 | 1.90 | 25 x 50 | 2.57 |
| 8200 | 828 | | | 22 x 35 | 1.87 | 25 x 35 | 2.14 | 25 x 50 | 2.57 |
| | | | | | | 30 x 30 | 2.15 | 30 x 35 | 2.50 |
| | | | | | | 35 x 25 | 2.19 | 35 x 30 | 2.55 |
| 10000 | 109 | 22 x 30 | 1.65 | 22 x 40 | 2.12 | 22 x 50 | 2.45 | 30 x 40 | 2.86 |
| | | | | 25 x 30 | 2.07 | | | | |
| | | 25 x 25 | 1.64 | 30 x 25 | 2.11 | 25 x 40 | 2.43 | 35 x 35 | 2.88 |
| 12000 | 129 | 22 x 35 | 1.85 | 25 x 35 | 2.37 | 25 x 50 | 2.78 | 30 x 50 | 3.32 |
| | | 25 x 30 | 1.85 | 30 x 30 | 2.37 | 30 x 35 | 2.70 | 35 x 40 | 3.30 |
| | | 30 x 25 | 1.89 | 35 x 25 | 2.42 | 35 x 30 | 2.76 | | |
| 15000 | 159 | 22 x 40 | 2.12 | 22 x 50 | 2.74 | 30 x 40 | 3.13 | | |
| | | 25 x 35 | 2.16 | 25 x 40 | 2.71 | 35 x 35 | 3.16 | | |
| 18000 | 189 | 22 x 50 | 2.45 | 25 x 50 | 3.11 | 30 x 50 | 3.64 | 35 x 50 | 4.29 |
| | | 25 x 40 | 2.43 | | | | | | |
| | | 30 x 30 | 2.37 | 30 x 35 | 3.02 | | | | |
| | | 35 x 25 | 2.42 | 35 x 30 | 3.09 | 35 x 40 | 3.61 | | |
| 22000 | 229 | 30 x 35 | 2.73 | 30 x 40 | 3.46 | | | | |
| | | 35 x 30 | 2.79 | 35 x 35 | 3.49 | | | | |
| 27000 | 279 | 25 x 50 | 3.11 | 30 x 50 | 4.07 | 35 x 50 | 4.70 | | |
| | | 30 x 40 | 3.13 | 35 x 40 | 4.04 | | | | |
| 33000 | 339 | 35 x 35 | 3.49 | | | | | | |
| 39000 | 399 | 30 x 50 | 3.99 | 35 x 50 | 5.16 | | | | |
| | | 35 x 40 | 3.96 | | | | | | |
| 47000 | 479 | 35 x 50 | 4.62 | | | | | | |

Maximum Allowable Ripple Current (Arms) at 105°C 120Hz

Case Size $\Phi D \times L$ (mm)

Specifications are subject to change without notice. Should a safety or technical concern arise regarding the product, please be sure to contact our sales offices or agents immediately.

STANDARD RATINGS

| Voltage (Code) | | 50V (1H) | | 63V (1J) | | 80V (1K) | | 100V (2A) | |
|----------------|------|-----------|----------------|-----------|----------------|-----------|----------------|-----------|----------------|
| Cap. (μF) | Code | Case Size | Ripple Current | Case Size | Ripple Current | Case Size | Ripple Current | Case Size | Ripple Current |
| 390 | 397 | | | | | | | 22 x 25 | 0.78 |
| 560 | 567 | | | | | | | 22 x 30 | 0.99 |
| | | | | | | | | 25 x 25 | 0.98 |
| 680 | 687 | | | | | 22 x 25 | 0.97 | 22 x 35 | 1.12 |
| | | | | | | | | 22 x 40 | 1.26 |
| 820 | 827 | | | | | 22 x 30 | 1.12 | 25 x 30 | 1.23 |
| | | | | | | | | 30 x 25 | 1.25 |
| 1000 | 108 | | | 22 x 25 | 1.00 | 22 x 35 | 1.70 | 25 x 35 | 1.41 |
| | | | | | | 25 x 25 | 1.92 | 30 x 30 | 1.42 |
| | | | | | | | | 35 x 25 | 1.45 |
| 1200 | 128 | | | 22 x 30 | 1.15 | 22 x 40 | 1.42 | 22 x 50 | 1.60 |
| | | | | | | 25 x 30 | 1.39 | 25 x 40 | 1.59 |
| | | | | 25 x 25 | 1.15 | 30 x 25 | 1.41 | 30 x 35 | 1.61 |
| 1500 | 158 | 22 x 25 | 1.02 | 22 x 35 | 1.32 | 25 x 35 | 1.62 | 25 x 50 | 1.86 |
| | | | | | | | | 30 x 40 | 1.87 |
| | | | | | | | | 35 x 30 | 1.85 |
| 1800 | 188 | 22 x 30 | 1.17 | 22 x 40 | 1.49 | 22 x 50 | 1.84 | | |
| | | | | 25 x 30 | 1.45 | 25 x 40 | 1.82 | 35 x 35 | 2.07 |
| | | 25 x 25 | 1.17 | 30 x 25 | 1.48 | 30 x 30 | 1.78 | | |
| | | | | | | 35 x 25 | 1.82 | | |
| 2200 | 228 | 22 x 35 | 1.33 | 25 x 35 | 1.67 | 25 x 50 | 2.11 | 30 x 50 | 2.40 |
| | | | | 30 x 30 | 1.68 | 30 x 35 | 2.05 | | |
| | | | | 35 x 25 | 1.71 | 35 x 30 | 2.09 | 35 x 40 | 2.39 |
| 2700 | 278 | 22 x 40 | 1.51 | 22 x 50 | 1.92 | 30 x 40 | 2.35 | | |
| | | 25 x 30 | 1.47 | 25 x 40 | 1.90 | | | 35 x 50 | 2.81 |
| | | 30 x 25 | 1.50 | 30 x 35 | 1.93 | 35 x 35 | 2.37 | | |
| 3300 | 338 | 25 x 35 | 1.70 | 25 x 50 | 2.20 | 30 x 50 | 2.75 | | |
| | | 30 x 30 | 1.70 | | | | | | |
| | | 35 x 25 | 1.74 | 35 x 30 | 2.18 | 35 x 40 | 2.73 | | |
| 3900 | 398 | 22 x 50 | 1.91 | 30 x 40 | 2.41 | | | | |
| | | 25 x 40 | 1.89 | 35 x 35 | 2.43 | | | | |
| 4700 | 478 | 30 x 35 | 2.11 | 30 x 50 | 2.80 | 35 x 50 | 3.46 | | |
| | | 35 x 30 | 2.16 | 35 x 40 | 2.78 | | | | |
| 5600 | 568 | 25 x 50 | 2.38 | | | | | | |
| | | 30 x 40 | 2.39 | | | | | | |
| | | 35 x 35 | 2.41 | | | | | | |
| 6800 | 688 | 30 x 50 | 2.79 | 35 x 50 | 3.55 | | | | |
| | | 35 x 40 | 2.78 | | | | | | |
| 10000 | 109 | 35 x 50 | 3.57 | | | | | | |

Maximum Allowable Ripple Current (Arms) at 105°C 120Hz

Case Size ΦD x L (mm)

Specifications are subject to change without notice. Should a safety or technical concern arise regarding the product, please be sure to contact our sales offices or agents immediately.

STANDARD RATINGS

| Voltage (Code) | | 160V (2C) | | 200V (2D) | | 250V (2E) | | 315V (2F) | |
|----------------|------|-----------|----------------|-----------|----------------|-----------|----------------|-----------|----------------|
| Cap. (µF) | Code | Case Size | Ripple Current | Case Size | Ripple Current | Case Size | Ripple Current | Case Size | Ripple Current |
| 150 | 157 | | | | | | | 22 x 30 | 0.86 |
| 180 | 187 | | | | | | | 22 x 35 | 0.98 |
| | | | | | | | | 25 x 30 | 1.01 |
| 220 | 227 | | | | | 22 x 30 | 1.09 | 22 x 40 | 1.10 |
| | | | | | | | | 30 x 25 | 1.17 |
| 270 | 277 | | | 22 x 25 | 1.10 | 22 x 35 | 1.28 | 22 x 45 | 1.24 |
| | | | | | | | | 25 x 35 | 1.27 |
| 330 | 337 | | | | | 25 x 30 | 1.42 | 22 x 50 | 1.39 |
| | | | | | | | | 25 x 40 | 1.45 |
| | | | | | | | | 30 x 30 | 1.40 |
| 390 | 397 | 22 x 30 | 1.42 | 22 x 35 | 1.47 | 22 x 45 | 1.61 | 25 x 45 | 1.60 |
| | | | | 25 x 30 | 1.50 | 25 x 35 | 1.53 | | |
| | | | | | | 30 x 30 | 1.62 | | |
| 470 | 477 | | | 22 x 40 | 1.64 | 22 x 50 | 1.79 | 25 x 50 | 1.78 |
| | | | | | | | | 30 x 40 | 1.81 |
| | | | | | | | | 35 x 30 | 1.82 |
| 560 | 567 | 22 x 35 | 1.77 | 22 x 45 | 1.82 | 25 x 45 | 1.98 | 30 x 45 | 2.02 |
| | | 25 x 30 | 1.81 | 25 x 35 | 1.82 | 30 x 35 | 1.95 | 35 x 35 | 2.00 |
| | | | | 30 x 25 | 1.78 | | | | |
| 680 | 687 | 22 x 40 | 1.98 | 22 x 50 | 1.90 | 25 x 50 | 2.21 | 30 x 50 | 2.21 |
| | | 25 x 35 | 2.01 | 25 x 40 | 1.98 | 30 x 40 | 2.18 | 35 x 40 | 2.29 |
| | | 30 x 25 | 1.96 | 30 x 30 | 1.98 | 35 x 30 | 2.15 | | |
| 820 | 827 | 22 x 45 | 2.20 | 25 x 45 | 2.20 | 30 x 45 | 2.45 | 35 x 45 | 2.57 |
| | | | | 30 x 35 | 2.22 | 35 x 35 | 2.38 | | |
| | | 25 x 45 | 2.65 | 25 x 50 | 2.46 | 30 x 50 | 2.68 | | |
| 1000 | 108 | 30 x 35 | 2.55 | 30 x 40 | 2.53 | 35 x 40 | 2.72 | 35 x 50 | 2.89 |
| | | 35 x 25 | 2.55 | 35 x 35 | 2.77 | | | | |
| | | 25 x 50 | 2.93 | 30 x 45 | 2.84 | | | | |
| 1200 | 128 | 30 x 40 | 2.84 | 35 x 35 | 2.88 | 35 x 45 | 3.05 | | |
| | | 35 x 30 | 2.86 | | | | | | |
| | | 30 x 45 | 3.17 | 35 x 40 | 3.34 | 35 x 50 | 3.49 | | |
| 1500 | 158 | 35 x 35 | 3.22 | | | | | | |
| | | 30 x 50 | 3.53 | 35 x 45 | 3.74 | | | | |
| 2200 | 228 | 35 x 45 | 4.14 | | | | | | |
| 2700 | 278 | 35 x 50 | 4.68 | | | | | | |

Maximum Allowable Ripple Current (Arms) at 105°C 120Hz

Case Size Φ D x L (mm)

Specifications are subject to change without notice. Should a safety or technical concern arise regarding the product, please be sure to contact our sales offices or agents immediately.

STANDARD RATINGS

| Voltage (Code) | | 350V (2V) | | 400V (2G) | | 420V (2M) | | 450V (2W) | |
|----------------|------|-------------------------------|----------------------|-------------------------------|----------------------|-------------------------------|----------------------|-------------------------------|----------------------|
| Cap. (μF) | Code | Case Size | Ripple Current | Case Size | Ripple Current | Case Size | Ripple Current | Case Size | Ripple Current |
| 82 | 826 | | | | | | | 22 x 30 | 0.64 |
| 100 | 107 | | | 22 x 30 | 0.71 | 22 x 30 | 0.71 | 22 x 35 25 x 30 | 0.74 0.75 |
| 120 | 127 | 22 x 30 | 0.78 | 22 x 35 | 0.80 | 22 x 35 25 x 30 | 0.80 0.83 | 22 x 40 | 0.82 |
| 150 | 157 | 22 x 35 | 0.90 | 22 x 40 25 x 35 | 0.91 0.99 | 22 x 40 | 0.91 | 22 x 45 25 x 35 30 x 30 | 0.93 0.94 1.00 |
| 180 | 187 | 25 x 30 | 1.01 | 22 x 45 25 x 35 30 x 30 | 1.01 1.03 1.10 | 22 x 45 25 x 40 30 x 30 | 1.01 1.10 1.10 | 22 x 50 25 x 40 30 x 30 | 1.01 1.03 1.03 |
| 220 | 227 | 22 x 45 25 x 35 30 x 30 | 1.16 1.14 1.21 | 22 x 50 25 x 40 | 1.14 1.19 | 25 x 45 30 x 35 35 x 25 | 1.20 1.21 1.22 | 25 x 45 30 x 35 35 x 30 | 1.16 1.17 1.24 |
| 270 | 277 | 22 x 50 25 x 40 30 x 30 | 1.26 1.31 1.27 | 25 x 50 30 x 35 | 1.39 1.35 | 25 x 50 30 x 40 35 x 30 | 1.35 1.37 1.38 | 25 x 50 30 x 40 35 x 35 | 1.31 1.33 1.39 |
| 330 | 337 | 25 x 45 30 x 35 | 1.46 1.43 | 30 x 45 35 x 30 | 1.59 1.52 | 30 x 45 35 x 35 | 1.50 1.54 | 30 x 50 | 1.58 |
| 390 | 397 | 25 x 50 30 x 40 35 x 35 | 1.62 1.60 1.76 | 30 x 45 35 x 35 | 1.68 1.67 | 30 x 50 35 x 40 | 1.72 1.73 | 35 x 40 | 1.73 |
| 470 | 477 | 30 x 45 35 x 35 | 1.81 1.83 | 30 x 50 35 x 40 | 1.89 1.90 | 35 x 45 | 1.94 | 35 x 50 | 1.98 |
| 560 | 567 | 30 x 50 35 x 40 | 2.00 2.07 | 35 x 45 | 2.12 | 35 x 50 | 2.17 | | |
| 680 | 687 | 35 x 45 | 2.34 | 35 x 50 | 2.39 | | | | |
| 820 | 827 | 35 x 50 | 2.62 | | | | | | |

Maximum Allowable Ripple Current (Arms) at 105°C 120Hz

Case Size ΦD x L (mm)

Specifications are subject to change without notice. Should a safety or technical concern arise regarding the product, please be sure to contact our sales offices or agents immediately.

FEATURES

- High ripple current and high reliability.
- Low equivalent series resistance ESR.
- Different case sizes available for each capacitance value.
- Load life with ripple current : 5,000 hours.



SPECIFICATIONS

| Item | Performance Characteristics | | | | | | | |
|---------------------------------|--|--|-----|-----|---|----|--------|---------|
| Operating Temperature Range | -40 to +105°C | -25 to +105°C | | | | | | |
| Rated Working Voltage Range | 10 to 100V | 200 to 450V | | | | | | |
| Nominal Capacitance Range | 100 to 33000µF | | | | | | | |
| Capacitance Tolerance | ±20% at 120Hz, +20°C | | | | | | | |
| Leakage Current | $I \leq 3\sqrt{CV}$ (µA) after 5 minutes application of rated working voltage at +20°C | | | | | | | |
| tan δ (120Hz, +20°C) | Working Voltage (V) | 10 16 25 35 50 63~100 200~400 450 | | | | | | |
| | tan δ (max.) | 0.60 0.45 0.30 0.25 0.20 0.15 0.15 0.20 | | | | | | |
| Low Temperature Characteristics | Impedance ratio max. at 120Hz | | | | | | | |
| | Working Voltage (V) | 10 | 16 | 25 | 35 | 50 | 63~100 | 200~400 |
| | Z-25°C / Z+20°C | 6 | 6 | 6 | 6 | 6 | 4 | 3 |
| | Z-40°C / Z+20°C | 15 | 15 | 15 | 15 | 15 | 15 | 15 |
| High Temperature Loading | Working Voltage (V) | 200 | 250 | 400 | 450 | | | |
| | Z-25°C / Z+20°C | 8 | 8 | 8 | 8 | | | |
| Shelf Life | Test time | : 5,000 hours | | | Post test requirements at +20°C | | | |
| | Test temperature | : +105°C | | | Leakage current : ≤Initial specified value | | | |
| Industrial Standard | Test conditions | : Rated DC working voltage with rated ripple current | | | Cap. change : within ±20% of the initial measured value | | | |
| | | | | | tan δ : ≤200% of the initial specified value | | | |
| Shelf Life | At +105°C no voltage applied after 1,000 hours and then being stabilized at +20°C the capacitors shall meet the following limits | | | | | | | |
| | Leakage current | : ≤Initial specified value | | | | | | |
| | Cap. change | : within ±15% of the initial measured value | | | | | | |
| Shelf Life | tan δ | : ≤150% of the initial specified value | | | | | | |
| | Industrial Standard | JIS C - 5101-4 (IEC 60384-4) | | | | | | |

RIPPLE CURRENT MULTIPLIER

Frequency Coefficient

| Coefficient | Freq. (Hz) | 60 | 120 | 1k | 10k~50k |
|-------------|------------|------|------|------|---------|
| | | | | | |
| | 10~100V | 0.90 | 1.00 | 1.15 | 1.25 |
| | 160~250V | 0.80 | 1.00 | 1.25 | 1.47 |
| | 315~450V | 0.80 | 1.00 | 1.30 | 1.47 |

PART NUMBER SYSTEM (EXAMPLE : 250V 330µF)

| | | | | | | | |
|---|-----|-------|---|-----|----|-------|-------|
| 1 | 2 3 | 4 5 6 | 7 | 8 9 | 10 | 11 12 | 13 14 |
| E | FP | 337 | M | 2 E | P | 3 0 | S W |

Type (Terminal Code)
 Case Length (30mm)
 Diameter (30mm)
 Voltage (250V)
 Tolerance (±20%)
 Capacitance (330µF)
 Series
 E-CAP

STANDARD RATINGS

| Voltage (Code) | | 10V (1A) | | | 16V (1C) | | | 25V (1E) | | |
|----------------|------|-----------|-----------|----------------|-----------|-----------|----------------|-----------|-----------|----------------|
| Cap. (μF) | Code | Case Size | Impedance | Ripple Current | Case Size | Impedance | Ripple Current | Case Size | Impedance | Ripple Current |
| 4700 | 478 | | | | | | | 22 x 30 | 57 | 1.6 |
| | | | | | | | | 25 x 25 | 57 | 1.6 |
| 6800 | 688 | 22 x 25 | 78 | 1.4 | 22 x 30 | 49 | 1.8 | 25 x 30 | 43 | 1.9 |
| 10000 | 109 | 22 x 30 | 56 | 1.8 | 25 x 30 | 36 | 2.2 | 25 x 40 | 32 | 2.5 |
| 15000 | 159 | 22 x 40 | 39 | 2.3 | 25 x 40 | 26 | 2.8 | 30 x 40 | 23 | 3.2 |
| 22000 | 229 | 30 x 35 | 28 | 3.0 | 30 x 40 | 18 | 3.5 | | | |
| 33000 | 339 | 30 x 45 | 20 | 3.9 | | | | | | |

Maximum Allowable Ripple Current (Arms) at 105°C 120Hz
Maximum Impedance (mΩ) at 20°C 20kHz

Case Size ΦD x L (mm)

| Voltage (Code) | | 35V (1V) | | | 50V (1H) | | | 63V (1J) | | |
|----------------|------|-----------|-----------|----------------|-----------|-----------|----------------|-----------|-----------|----------------|
| Cap. (μF) | Code | Case Size | Impedance | Ripple Current | Case Size | Impedance | Ripple Current | Case Size | Impedance | Ripple Current |
| 1000 | 108 | | | | | | | 22 x 25 | 159 | 1.0 |
| 1500 | 158 | | | | | | | 22 x 35 | 106 | 1.4 |
| 2200 | 228 | 22 x 25 | 90 | 1.1 | 22 x 35 | 90 | 1.4 | 25 x 35 | 72 | 1.7 |
| | | | | | | | | 30 x 30 | 85 | 1.8 |
| 3300 | 338 | 22 x 30 | 60 | 1.5 | 25 x 35 | 60 | 1.8 | 30 x 40 | 56 | 2.3 |
| | | 25 x 25 | 60 | 1.5 | | | | | | |
| 4700 | 478 | 22 x 40 | 48 | 1.9 | 30 x 35 | 45 | 2.2 | 35 x 35 | 45 | 2.7 |
| 6800 | 688 | 25 x 40 | 37 | 2.3 | 30 x 50 | 35 | 2.9 | 35 x 50 | 31 | 3.6 |
| 10000 | 109 | 30 x 40 | 28 | 2.9 | 35 x 45 | 26 | 3.6 | | | |
| 15000 | 159 | 35 x 40 | 20 | 3.8 | | | | | | |
| 18000 | 189 | 35 x 45 | 18 | 4.3 | | | | | | |

Maximum Allowable Ripple Current (Arms) at 105°C 120Hz
Maximum Impedance (mΩ) at 20°C 20kHz

Case Size ΦD x L (mm)

| Voltage (Code) | | 80V (1K) | | | 100V (2A) | | | 200V (2D) | | |
|----------------|------|-----------|-----------|----------------|-----------|-----------|----------------|-----------|-----------|----------------|
| Cap. (μF) | Code | Case Size | Impedance | Ripple Current | Case Size | Impedance | Ripple Current | Case Size | Impedance | Ripple Current |
| 220 | 227 | | | | | | | 22 x 30 | 700 | 0.96 |
| 330 | 337 | | | | | | | 22 x 40 | 470 | 1.3 |
| 470 | 477 | | | | | | | 25 x 40 | 330 | 1.7 |
| | | | | | | | | 30 x 30 | 330 | 1.7 |
| 560 | 567 | | | | 25 x 25 | 190 | 1.0 | | | |
| 680 | 687 | | | | 22 x 35 | 156 | 1.2 | 30 x 40 | 230 | 2.2 |
| 1000 | 108 | 25 x 25 | 133 | 1.3 | 25 x 35 | 106 | 1.4 | 35 x 45 | 160 | 3.1 |
| | | | | | 30 x 30 | 106 | 1.5 | | | |
| 1200 | 128 | 30 x 25 | 110 | 1.5 | | | | | | |
| 1500 | 158 | 25 x 35 | 89 | 1.8 | 30 x 40 | 70 | 1.9 | 35 x 50 | 110 | 3.9 |
| 2200 | 228 | 30 x 35 | 60 | 2.0 | 30 x 50 | 60 | 2.3 | | | |
| 3300 | 338 | 35 x 35 | 48 | 2.8 | 35 x 50 | 40 | 3.0 | | | |
| 4700 | 478 | 35 x 45 | 34 | 3.4 | | | | | | |

Maximum Allowable Ripple Current (Arms) at 105°C 120Hz
Maximum Impedance (mΩ) at 20°C 20kHz

Case Size ΦD x L (mm)

| Voltage (Code) | | 250V (2E) | | | 400V (2G) | | | 450V (2W) | | |
|----------------|------|-----------|-----------|----------------|-----------|-----------|----------------|-----------|-----------|----------------|
| Cap. (μF) | Code | Case Size | Impedance | Ripple Current | Case Size | Impedance | Ripple Current | Case Size | Impedance | Ripple Current |
| 100 | 107 | | | | 25 x 30 | 1090 | 0.7 | 22 x 45 | 1600 | 0.75 |
| | | | | | | | | 30 x 30 | 1600 | 0.76 |
| 150 | 157 | | | | 25 x 40 | 730 | 0.95 | 25 x 45 | 1070 | 1.0 |
| | | | | | 30 x 30 | 730 | 0.94 | 30 x 35 | 1070 | 0.99 |
| 220 | 227 | 25 x 30 | 700 | 1.0 | 30 x 40 | 500 | 1.3 | 30 x 45 | 730 | 1.3 |
| | | | | | 35 x 30 | 500 | 1.3 | 35 x 35 | 730 | 1.3 |
| 330 | 337 | 25 x 40 | 470 | 1.4 | 30 x 50 | 330 | 1.7 | 35 x 50 | 490 | 1.8 |
| | | 30 x 30 | 470 | 1.4 | 35 x 40 | 330 | 1.7 | | | |
| 390 | 397 | | | | 35 x 45 | 280 | 1.9 | 35 x 50 | 410 | 2.0 |
| 470 | 477 | 30 x 35 | 330 | 1.8 | 35 x 50 | 240 | 2.2 | | | |
| 680 | 687 | 30 x 45 | 230 | 2.3 | | | | | | |
| 1000 | 108 | 35 x 45 | 160 | 3.1 | | | | | | |

Maximum Allowable Ripple Current (Arms) at 105°C 120Hz
Maximum Impedance (mΩ) at 20°C 20kHz

Case Size ΦD x L (mm)

Specifications are subject to change without notice. Should a safety or technical concern arise regarding the product, please be sure to contact our sales offices or agents immediately.

FEATURES

- High ripple current and high reliability.
- Two or three dimensions with same ratings.
- Aluminum case designed explosion-proof vent.
- Best for ballast application.
- Load life with ripple current : 105°C 7,000 hours.



SPECIFICATIONS

| Item | Performance Characteristics | | | | | | | | |
|---------------------------------|--|---|------|------|---------------|---|------|------|--|
| Operating Temperature Range | -40 to +105°C | | | | -25 to +105°C | | | | |
| Rated Working Voltage Range | 160 to 250V | | | | 315 to 450V | | | | |
| Nominal Capacitance Range | 39 to 2200µF | | | | | | | | |
| Capacitance Tolerance | ±20% at 120Hz, +20°C | | | | | | | | |
| Leakage Current | I ≤ 3√CV (µA) after 5 minutes application of rated working voltage at +20°C | | | | | | | | |
| tan δ (120Hz, +20°C) | Working Voltage (V) | 160 | 200 | 250 | 315 | 350 | 400 | 450 | |
| | tan δ (max.) | 0.15 | 0.15 | 0.15 | 0.15 | 0.15 | 0.15 | 0.20 | |
| Low Temperature Characteristics | Impedance ratio max. at 120Hz | | | | | | | | |
| | Working Voltage (V) | 160~250 | | | 315~450 | | | | |
| | Z-25°C / Z+20°C | 3 | | | 8 | | | | |
| High Temperature Loading | Z-40°C / Z+20°C | 15 | | | - | | | | |
| | Test time | : 7,000 hours | | | | Post test requirements at +20°C | | | |
| | Test temperature | : +105°C | | | | Leakage current : ≤Initial specified value | | | |
| Shelf Life | Test conditions | : Rated DC working voltage with rated ripple current | | | | Cap. change : within ±20% of the initial measured value | | | |
| | | | | | | tan δ : ≤250% of the initial specified value | | | |
| Industrial Standard | JIS C - 5101-4 (IEC 60384-4) | | | | | | | | |

RIPPLE CURRENT MULTIPLIER

Frequency Coefficient

| Coefficient Rated Voltage | Freq. (Hz) | 60 | 120 | 1k | 10k~50k |
|------------------------------|------------|----------|------|------|---------|
| | | 160~250V | 0.80 | 1.00 | 1.25 |
| 315~450V | 0.80 | 1.00 | 1.30 | 1.47 | |

PART NUMBER SYSTEM (EXAMPLE : 400V 100µF)

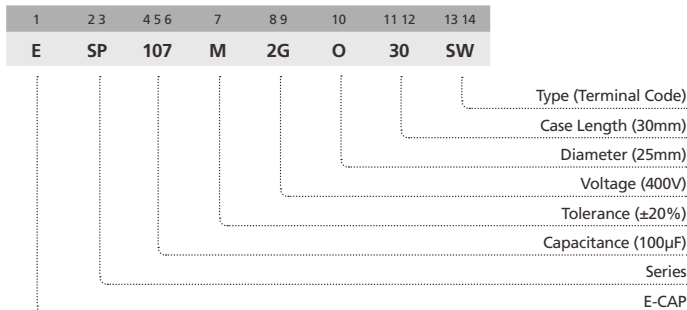

STANDARD RATINGS

| Voltage (Code) | | 160V (2C) | | 200V (2D) | | 250V (2E) | | 315V (2F) | |
|----------------|------|-----------|----------------|-----------|----------------|-----------|----------------|-----------|----------------|
| Cap. (μF) | Code | Case Size | Ripple Current | Case Size | Ripple Current | Case Size | Ripple Current | Case Size | Ripple Current |
| 82 | 826 | | | | | | | 22 x 25 | 0.64 |
| 100 | 107 | | | | | | | 22 x 30 | 0.69 |
| 120 | 127 | | | | | | | 22 x 30 | 0.75 |
| | | | | | | | | 25 x 25 | 0.75 |
| 150 | 157 | | | | | | | 22 x 35 | 0.82 |
| | | | | | | | | 25 x 30 | 0.82 |
| | | | | | | | | 30 x 25 | 0.82 |
| 180 | 187 | | | | | 22 x 30 | 0.90 | 22 x 40 | 0.90 |
| | | | | | | 25 x 25 | 0.90 | 25 x 35 | 0.90 |
| 220 | 227 | | | | | | | 30 x 25 | 0.90 |
| | | | | 22 x 25 | 1.00 | 22 x 30 | 1.00 | 22 x 45 | 1.00 |
| | | | | | | 25 x 25 | 1.00 | 25 x 40 | 1.00 |
| 270 | 277 | 22 x 25 | 1.10 | 22 x 30 | 1.10 | 22 x 35 | 1.10 | 25 x 45 | 1.10 |
| | | | | 25 x 25 | 1.10 | 25 x 30 | 1.10 | 30 x 35 | 1.10 |
| | | | | | | 30 x 25 | 1.10 | 35 x 30 | 1.10 |
| 330 | 337 | 22 x 30 | 1.20 | 22 x 30 | 1.20 | 22 x 40 | 1.20 | 25 x 50 | 1.20 |
| | | | | 25 x 25 | 1.20 | 25 x 35 | 1.20 | 30 x 40 | 1.20 |
| | | | | | | 30 x 25 | 1.20 | 35 x 30 | 1.20 |
| 390 | 397 | 22 x 30 | 1.30 | 22 x 35 | 1.30 | 22 x 45 | 1.30 | 30 x 45 | 1.30 |
| | | | | 25 x 25 | 1.30 | 25 x 30 | 1.30 | 25 x 35 | 1.30 |
| | | | | | | 30 x 25 | 1.30 | 30 x 30 | 1.30 |
| 470 | 477 | 22 x 35 | 1.40 | 22 x 40 | 1.40 | 25 x 45 | 1.40 | 30 x 50 | 1.40 |
| | | | | 25 x 30 | 1.40 | 25 x 35 | 1.40 | 30 x 35 | 1.40 |
| | | | | | | 30 x 30 | 1.40 | 35 x 30 | 1.40 |
| 560 | 567 | 22 x 40 | 1.50 | 22 x 45 | 1.50 | 25 x 50 | 1.50 | 35 x 45 | 1.50 |
| | | | | 25 x 30 | 1.50 | 25 x 35 | 1.50 | | |
| | | | | 30 x 25 | 1.50 | 30 x 30 | 1.50 | | |
| 680 | 687 | 22 x 45 | 1.70 | 25 x 40 | 1.70 | 30 x 45 | 1.70 | 35 x 50 | 1.70 |
| | | | | 25 x 35 | 1.70 | 25 x 40 | 1.70 | | |
| | | | | 30 x 30 | 1.70 | 30 x 35 | 1.70 | | |
| 820 | 827 | 25 x 40 | 2.00 | 25 x 50 | 2.00 | 30 x 50 | 2.00 | | |
| | | | | 30 x 40 | 2.00 | 30 x 40 | 2.00 | | |
| | | | | 30 x 30 | 2.00 | 35 x 30 | 2.00 | | |
| 1000 | 108 | 25 x 45 | 2.20 | 30 x 45 | 2.20 | 35 x 45 | 2.20 | | |
| | | 30 x 35 | 2.20 | 35 x 35 | 2.20 | | | | |
| 1200 | 128 | 25 x 50 | 2.30 | 30 x 50 | 2.30 | 35 x 50 | 2.30 | | |
| | | 30 x 40 | 2.30 | 35 x 40 | 2.30 | | | | |
| | | 35 x 35 | 2.30 | | | | | | |
| 1500 | 158 | 30 x 45 | 2.50 | 35 x 50 | 2.50 | | | | |
| | | 35 x 35 | 2.50 | | | | | | |
| 1800 | 188 | 30 x 50 | 2.70 | | | | | | |
| | | 35 x 40 | 2.70 | | | | | | |
| 2200 | 228 | 35 x 50 | 2.90 | | | | | | |

Maximum Allowable Ripple Current (Arms) at 105°C 120Hz

Case Size ΦD x L (mm)

Specifications are subject to change without notice. Should a safety or technical concern arise regarding the product, please be sure to contact our sales offices or agents immediately.

STANDARD RATINGS

| Voltage (Code) | | 350V (2V) | | 400V (2G) | | 450V (2W) | |
|----------------|------|-----------|----------------|-----------|----------------|-----------|----------------|
| Cap. (µF) | Code | Case Size | Ripple Current | Case Size | Ripple Current | Case Size | Ripple Current |
| 39 | 396 | | | | | 22 x 25 | 0.37 |
| 47 | 476 | | | | | 22 x 30 | 0.40 |
| 56 | 566 | | | | | 22 x 35 | 0.47 |
| | | | | | | 25 x 25 | 0.47 |
| 68 | 686 | | | | | 22 x 40 | 0.53 |
| | | | | | | 25 x 30 | 0.53 |
| 82 | 826 | 22 x 25 | 0.64 | 22 x 35 | 0.64 | 22 x 45 | 0.56 |
| | | | | 25 x 25 | 0.64 | 25 x 35 | 0.56 |
| 100 | 107 | 22 x 30 | 0.69 | 22 x 35 | 0.69 | 22 x 50 | 0.64 |
| | | 25 x 25 | 0.69 | 25 x 30 | 0.69 | 25 x 40 | 0.64 |
| 120 | 127 | 22 x 35 | 0.75 | 22 x 40 | 0.75 | 30 x 30 | 0.64 |
| | | 25 x 30 | 0.75 | 25 x 35 | 0.75 | 25 x 45 | 0.72 |
| 150 | 157 | 22 x 40 | 0.82 | 22 x 50 | 0.82 | 30 x 30 | 0.72 |
| | | 25 x 30 | 0.82 | 25 x 40 | 0.82 | 25 x 50 | 0.79 |
| | | 30 x 25 | 0.82 | 30 x 30 | 0.82 | 30 x 40 | 0.79 |
| 180 | 187 | 22 x 45 | 0.90 | 25 x 45 | 0.90 | 35 x 30 | 0.79 |
| | | 25 x 35 | 0.90 | 30 x 35 | 0.90 | 30 x 45 | 0.87 |
| | | 30 x 30 | 0.90 | 35 x 25 | 0.90 | 35 x 35 | 0.87 |
| 220 | 227 | 22 x 50 | 1.00 | 25 x 50 | 1.00 | 35 x 35 | 0.87 |
| | | 25 x 40 | 1.00 | 30 x 40 | 1.00 | 30 x 50 | 1.00 |
| | | 30 x 30 | 1.00 | 35 x 30 | 1.00 | 35 x 40 | 1.00 |
| 270 | 277 | 25 x 50 | 1.10 | 30 x 45 | 1.10 | 35 x 40 | 1.00 |
| | | 30 x 35 | 1.10 | 35 x 35 | 1.10 | 35 x 45 | 1.19 |
| | | 35 x 30 | 1.10 | | | | |
| 330 | 337 | 30 x 45 | 1.20 | 30 x 50 | 1.20 | 35 x 50 | 1.38 |
| | | 35 x 35 | 1.20 | 35 x 40 | 1.20 | | |
| 390 | 397 | 30 x 50 | 1.30 | 35 x 45 | 1.30 | | |
| | | 35 x 40 | 1.30 | | | | |
| 470 | 477 | 35 x 40 | 1.40 | 35 x 50 | 1.40 | | |
| 560 | 567 | 35 x 50 | 1.50 | | | | |

Maximum Allowable Ripple Current (Arms) at 105°C 120Hz

Case Size Φ D x L (mm)

Specifications are subject to change without notice. Should a safety or technical concern arise regarding the product, please be sure to contact our sales offices or agents immediately.

FEATURES

- Designed for withstanding vibration.
- Suited for washing machines and etc.



SPECIFICATIONS

| Item | Performance Characteristics | | | | | | | |
|---|--|--|---------|---------|---|---------|---------|------|
| Operating Temperature Range | -40 to +105°C | | | | -25 to +105°C | | | |
| Rated Working Voltage Range | 10 to 100V | | | | 160 to 500V | | | |
| Nominal Capacitance Range | 39 to 56000µF | | | | | | | |
| Capacitance Tolerance | ±20% at 120Hz, +20°C | | | | | | | |
| Leakage Current | I ≤ 3√CV (µA) after 5 minutes application of rated working voltage at +20°C | | | | | | | |
| tan δ (120Hz, +20°C) | Working Voltage (V) | 10 | 16 | 25 | 35 | 50 | 63 | 80 |
| | tan δ (max.) | 0.55 | 0.50 | 0.45 | 0.35 | 0.30 | 0.30 | 0.25 |
| | Working Voltage (V) | 100 | 160~250 | 315~450 | 500 | | | |
| | tan δ (max.) | 0.20 | 0.15 | 0.15 | 0.20 | | | |
| For capacitance value >33000µF, add following calculated value: $\frac{(\text{rated capacitance}) - 33000\mu\text{F}}{10000\mu\text{F}} \times 0.1$ | | | | | | | | |
| Low Temperature Characteristics | Impedance ratio max. at 120Hz | | | | | | | |
| | Working Voltage (V) | 10~25 | 35 | 50 | 63~100 | 160~250 | 315~450 | 500 |
| | Z-25°C / Z+20°C | 4 | 6 | 4 | 3 | 8 | 8 | 8 |
| | Z-40°C / Z+20°C | 15 | 15 | 15 | 15 | - | - | - |
| High Temperature Loading | Test time | : 2,000 hours | | | Post test requirements at +20°C | | | |
| | Test temperature | : +105°C | | | Leakage current : ≤Initial specified value | | | |
| | Test conditions | : Rated DC working voltage with rated ripple current | | | Cap. change : within ±20% of the initial measured value | | | |
| | | | | | tan δ : ≤200% of the initial specified value | | | |
| Shelf Life | At +105°C no voltage applied after 1,000 hours and then being stabilized at +20°C the capacitors shall meet the following limits | | | | | | | |
| | Leakage current : ≤Initial specified value | | | | | | | |
| | Cap. change : within ±15% of the initial measured value | | | | | | | |
| | tan δ : ≤150% of the initial specified value | | | | | | | |
| Industrial Standard | JIS C - 5101-4 (IEC 60384-4) | | | | | | | |

RIPPLE CURRENT MULTIPLIER

Frequency Coefficient

| Coefficient | 60 | 120 | 1k | 10k~50k |
|---------------|------|------|------|---------|
| Rated Voltage | | | | |
| 10~100V | 0.90 | 1.00 | 1.15 | 1.25 |
| 160~250V | 0.80 | 1.00 | 1.25 | 1.47 |
| 315~500V | 0.80 | 1.00 | 1.30 | 1.47 |

PART NUMBER SYSTEM (EXAMPLE : 200V 470µF)

| | | | | | | | |
|---|----|-----|---|----|----|------|------|
| 1 | 23 | 456 | 7 | 89 | 10 | 1112 | 1314 |
| E | VP | 477 | M | 2D | O | 30 | SW |

Type (Terminal Code)
 Case Length (30mm)
 Diameter (25mm)
 Voltage (200V)
 Tolerance (±20%)
 Capacitance (470µF)
 Series
 E-CAP

STANDARD RATINGS

| Voltage (Code) | | 10V (1A) | | 16V (1C) | | 25V (1E) | | 35V (1V) | |
|----------------|------|-----------|----------------|-----------|----------------|-----------|----------------|-----------|----------------|
| Cap. (µF) | Code | Case Size | Ripple Current | Case Size | Ripple Current | Case Size | Ripple Current | Case Size | Ripple Current |
| 2700 | 278 | | | | | | | 20 x 25 | 1.29 |
| 3300 | 338 | | | | | | | 20 x 30 | 1.57 |
| 3900 | 398 | | | | | 20 x 25 | 1.58 | 22 x 25 | 1.45 |
| 4700 | 478 | | | | | 20 x 30 | 1.65 | 20 x 35 | 1.78 |
| 5600 | 568 | | | 20 x 25 | 1.68 | 22 x 30 | 1.61 | 22 x 30 | 1.69 |
| 6800 | 688 | 20 x 25 | 1.31 | 20 x 30 | 1.80 | 20 x 35 | 1.85 | 20 x 40 | 2.02 |
| 8200 | 828 | 20 x 30 | 1.59 | 22 x 25 | 1.75 | 22 x 35 | 1.61 | 22 x 35 | 2.02 |
| 10000 | 109 | 20 x 30 | 1.88 | 20 x 35 | 2.08 | 25 x 25 | 1.87 | 25 x 25 | 1.62 |
| 12000 | 129 | 22 x 25 | 1.77 | 22 x 40 | 2.31 | 22 x 40 | 2.31 | 22 x 35 | 2.13 |
| 15000 | 159 | 20 x 35 | 2.18 | 22 x 30 | 2.10 | 25 x 30 | 2.34 | 25 x 30 | 2.00 |
| 18000 | 189 | 22 x 30 | 2.10 | 25 x 25 | 2.05 | 30 x 25 | 2.16 | 25 x 35 | 2.41 |
| 22000 | 229 | 25 x 25 | 1.94 | 22 x 40 | 2.68 | 30 x 30 | 2.65 | 30 x 25 | 2.31 |
| 27000 | 279 | 20 x 40 | 2.27 | 25 x 30 | 2.30 | 35 x 30 | 3.26 | 30 x 25 | 2.31 |
| 33000 | 339 | 22 x 35 | 2.23 | 30 x 25 | 2.30 | 35 x 35 | 3.75 | 22 x 50 | 2.85 |
| 39000 | 399 | 25 x 30 | 2.10 | 22 x 50 | 3.20 | 35 x 40 | 3.56 | 25 x 40 | 2.73 |
| 47000 | 479 | 22 x 40 | 2.41 | 25 x 40 | 3.16 | 35 x 45 | 4.74 | 25 x 40 | 2.73 |
| 56000 | 569 | 25 x 30 | 2.10 | 30 x 30 | 2.57 | 35 x 50 | 5.50 | 30 x 30 | 2.75 |
| | | 22 x 40 | 2.41 | 30 x 30 | 2.57 | | | 30 x 30 | 2.75 |
| | | 25 x 30 | 2.34 | 30 x 30 | 2.57 | | | 30 x 30 | 2.75 |
| | | 30 x 25 | 2.25 | 35 x 30 | 3.25 | | | 30 x 30 | 2.75 |
| | | 22 x 45 | 2.58 | 35 x 30 | 3.25 | | | 30 x 30 | 2.75 |
| | | 25 x 35 | 2.54 | 35 x 30 | 3.25 | | | 30 x 30 | 2.75 |
| | | 30 x 30 | 2.50 | 35 x 30 | 3.25 | | | 30 x 30 | 2.75 |
| | | 22 x 50 | 3.17 | 35 x 35 | 3.93 | | | 30 x 30 | 2.75 |
| | | 25 x 40 | 3.07 | 35 x 35 | 3.93 | | | 30 x 30 | 2.75 |
| | | 30 x 30 | 2.95 | 35 x 35 | 3.93 | | | 30 x 30 | 2.75 |
| | | 25 x 45 | 3.39 | 35 x 35 | 3.93 | | | 30 x 30 | 2.75 |
| | | 30 x 35 | 3.33 | 35 x 35 | 3.93 | | | 30 x 30 | 2.75 |
| | | 35 x 30 | 3.21 | 35 x 35 | 3.93 | | | 30 x 30 | 2.75 |
| | | 30 x 40 | 3.70 | 35 x 35 | 3.93 | | | 30 x 30 | 2.75 |
| | | 35 x 35 | 3.68 | 35 x 35 | 3.93 | | | 30 x 30 | 2.75 |
| | | 30 x 45 | 4.22 | 35 x 35 | 3.93 | | | 30 x 30 | 2.75 |
| | | 35 x 40 | 4.16 | 35 x 35 | 3.93 | | | 30 x 30 | 2.75 |
| | | 35 x 50 | 5.00 | 35 x 35 | 3.93 | | | 30 x 30 | 2.75 |

Maximum Allowable Ripple Current (Arms) at 105°C 120Hz

Case Size ϕ D x L (mm)

STANDARD RATINGS

| Voltage (Code) | | 50V (1H) | | 63V (1J) | | 80V (1K) | | 100V (2A) | |
|----------------|------|-----------|----------------|-----------|----------------|-----------|----------------|-----------|----------------|
| Cap. (μF) | Code | Case Size | Ripple Current | Case Size | Ripple Current | Case Size | Ripple Current | Case Size | Ripple Current |
| 560 | 567 | | | | | | | 20 x 25 | 0.95 |
| 680 | 687 | | | | | | | 20 x 30 | 1.15 |
| | | | | | | | | 22 x 25 | 1.09 |
| 820 | 827 | | | | | 20 x 25 | 1.04 | 20 x 35 | 1.31 |
| | | | | | | | | 22 x 30 | 1.32 |
| 1000 | 108 | | | 20 x 25 | 1.10 | 20 x 30 | 1.24 | 20 x 35 | 1.43 |
| | | | | | | 22 x 25 | 1.19 | 22 x 30 | 1.47 |
| | | | | | | | | 25 x 25 | 1.45 |
| 1200 | 128 | | | 20 x 30 | 1.20 | 20 x 35 | 1.43 | 20 x 40 | 1.61 |
| | | | | 22 x 25 | 1.20 | 22 x 30 | 1.44 | 22 x 35 | 1.69 |
| | | | | | | | | 25 x 30 | 1.68 |
| 1500 | 158 | 20 x 25 | 1.15 | 20 x 35 | 1.47 | 20 x 35 | 1.57 | 22 x 40 | 1.97 |
| | | | | 22 x 30 | 1.47 | 22 x 30 | 1.59 | 25 x 35 | 1.98 |
| | | | | | | 25 x 25 | 1.59 | 30 x 25 | 1.95 |
| 1800 | 188 | 20 x 30 | 1.39 | 20 x 35 | 1.58 | 20 x 40 | 1.77 | 22 x 45 | 2.23 |
| | | 22 x 25 | 1.34 | 22 x 30 | 1.58 | 22 x 35 | 1.79 | 25 x 40 | 2.20 |
| | | | | 25 x 25 | 1.52 | 25 x 30 | 1.71 | 30 x 30 | 2.20 |
| 2200 | 228 | 20 x 35 | 1.60 | 20 x 40 | 1.80 | 22 x 40 | 2.03 | 25 x 45 | 2.53 |
| | | 22 x 30 | 1.60 | 22 x 35 | 1.82 | 25 x 35 | 1.98 | 30 x 35 | 2.55 |
| | | | | 25 x 30 | 1.75 | 30 x 25 | 1.98 | 35 x 30 | 2.50 |
| 2700 | 278 | 20 x 35 | 1.73 | 22 x 40 | 2.07 | 22 x 45 | 2.39 | 25 x 50 | 2.82 |
| | | 22 x 30 | 1.70 | 25 x 35 | 2.11 | 25 x 40 | 2.35 | 30 x 40 | 2.86 |
| | | 25 x 25 | 1.70 | 30 x 25 | 1.72 | 30 x 30 | 2.35 | 35 x 35 | 2.89 |
| 3300 | 338 | 20 x 40 | 1.97 | 22 x 45 | 2.33 | 25 x 45 | 2.64 | 30 x 45 | 3.30 |
| | | 22 x 35 | 1.97 | 25 x 35 | 2.27 | 30 x 35 | 2.61 | 35 x 35 | 3.25 |
| | | 25 x 30 | 1.88 | 30 x 30 | 2.24 | 35 x 30 | 2.47 | | |
| 3900 | 398 | 22 x 40 | 2.22 | 25 x 40 | 2.51 | 25 x 50 | 2.92 | 30 x 50 | 3.60 |
| | | 25 x 30 | 2.20 | | | 30 x 40 | 2.82 | | |
| | | 30 x 25 | 1.95 | 30 x 35 | 2.55 | 35 x 30 | 2.97 | 35 x 40 | 3.67 |
| 4700 | 478 | 22 x 45 | 2.43 | 25 x 50 | 2.91 | 30 x 45 | 3.34 | | |
| | | 25 x 35 | 2.43 | 30 x 40 | 2.86 | | | 35 x 45 | 3.80 |
| | | 30 x 30 | 2.25 | 35 x 30 | 2.80 | 35 x 35 | 3.38 | | |
| 5600 | 568 | 22 x 50 | 2.75 | 30 x 40 | 3.22 | 30 x 50 | 3.80 | | |
| | | 25 x 40 | 2.72 | | | | | 35 x 50 | 4.05 |
| | | 30 x 30 | 2.64 | 35 x 35 | 3.20 | 35 x 40 | 3.80 | | |
| 6800 | 688 | 25 x 45 | 3.30 | 30 x 50 | 3.65 | | | | |
| | | 30 x 35 | 3.30 | | | 35 x 45 | 3.90 | | |
| | | 35 x 30 | 3.25 | 35 x 40 | 3.65 | | | | |
| 8200 | 828 | 30 x 40 | 3.60 | | | | | | |
| | | 35 x 35 | 3.60 | 35 x 45 | 4.04 | 35 x 50 | 4.20 | | |
| 10000 | 109 | 30 x 50 | 4.05 | | | | | | |
| | | 35 x 40 | 4.04 | 35 x 50 | 4.48 | | | | |
| 12000 | 129 | 35 x 45 | 4.56 | | | | | | |
| 15000 | 159 | 35 x 50 | 4.77 | | | | | | |

Maximum Allowable Ripple Current (Arms) at 105°C 120Hz

Case Size φD x L (mm)

Specifications are subject to change without notice. Should a safety or technical concern arise regarding the product, please be sure to contact our sales offices or agents immediately.

STANDARD RATINGS

| Voltage (Code) | | 160V (2C) | | 180V (2P) | | 220V (2D) | | 220V (2N) | |
|----------------|------|-------------------------------|----------------------|-------------------------------|----------------------|-------------------------------|----------------------|--|------------------------------|
| Cap. (µF) | Code | Case Size | Ripple Current | Case Size | Ripple Current | Case Size | Ripple Current | Case Size | Ripple Current |
| 180 | 187 | | | | | | | 20 x 25 | 0.81 |
| 220 | 227 | | | 20 x 25 | 0.81 | 20 x 25 | 0.83 | 20 x 30 22 x 25 | 0.94 0.94 |
| 270 | 277 | 20 x 25 | 0.87 | 20 x 30 22 x 25 | 0.95 0.97 | 20 x 30 22 x 25 | 0.97 0.99 | 20 x 35 22 x 30 | 1.10 1.09 |
| 330 | 337 | 20 x 30 22 x 25 | 1.02 1.03 | 20 x 35 22 x 30 | 1.09 1.13 | 20 x 35 22 x 30 25 x 25 | 1.17 1.20 1.20 | 20 x 40 22 x 35 25 x 25 | 1.18 1.24 1.14 |
| 390 | 397 | 20 x 35 22 x 30 | 1.15 1.17 | 20 x 35 25 x 25 | 1.28 1.33 | 20 x 40 25 x 25 | 1.27 1.34 | 20 x 45 25 x 30 | 1.33 1.26 |
| 470 | 477 | 20 x 40 22 x 30 25 x 25 | 1.25 1.28 1.29 | 20 x 40 22 x 35 25 x 30 | 1.34 1.39 1.43 | 22 x 40 25 x 30 30 x 25 | 1.44 1.44 1.48 | 22 x 40 25 x 30 30 x 25 | 1.41 1.39 1.37 |
| 560 | 567 | 22 x 35 25 x 30 | 1.45 1.49 | 22 x 40 25 x 30 30 x 25 | 1.56 1.53 1.56 | 22 x 45 25 x 35 30 x 30 | 1.60 1.60 1.60 | 22 x 45 25 x 35 30 x 30 35 x 25 | 1.60 1.56 1.61 1.52 |
| 680 | 687 | 22 x 40 25 x 35 30 x 25 | 1.64 1.70 1.63 | 22 x 45 25 x 35 30 x 30 | 1.76 1.76 1.74 | 22 x 50 25 x 40 30 x 30 | 1.75 1.76 1.74 | 25 x 40 30 x 35 35 x 30 | 1.75 1.76 1.72 |
| 820 | 827 | 22 x 45 25 x 40 30 x 30 | 1.85 1.92 1.91 | 22 x 50 25 x 40 30 x 30 | 1.97 1.99 1.93 | 25 x 45 30 x 35 35 x 30 | 2.10 2.11 2.10 | 25 x 45 30 x 40 35 x 30 | 1.97 2.06 1.95 |
| 1000 | 108 | 25 x 45 30 x 35 | 2.17 2.19 | 25 x 45 30 x 35 35 x 30 | 2.24 2.24 2.20 | 25 x 50 30 x 40 35 x 35 | 2.36 2.40 2.30 | 30 x 45 35 x 35 | 2.44 2.20 |
| 1200 | 128 | 25 x 50 30 x 40 35 x 30 | 2.43 2.48 2.25 | 30 x 40 35 x 35 | 2.53 2.54 | 30 x 45 35 x 35 | 2.69 2.53 | 35 x 40 | 2.37 |
| 1500 | 158 | 30 x 45 35 x 35 | 2.82 2.62 | 30 x 50 35 x 40 | 3.03 2.91 | 35 x 40 | 2.97 | 35 x 45 | 2.64 |
| 1800 | 188 | 30 x 50 35 x 40 | 3.13 2.97 | 35 x 45 | 3.25 | 35 x 50 | 3.45 | | |
| 2200 | 228 | 35 x 45 | 3.34 | 35 x 50 | 3.62 | | | | |

Maximum Allowable Ripple Current (Arms) at 105°C 120Hz

Case Size Φ D x L (mm)

STANDARD RATINGS

| Voltage (Code) | | 250V (2E) | | 315V (2F) | | 350V (2V) | | 385V (2Y) | |
|----------------|------|-------------------------------|----------------------|-------------------------------|----------------------|-------------------------------|----------------------|-------------------------------|----------------------|
| Cap. (μF) | Code | Case Size | Ripple Current | Case Size | Ripple Current | Case Size | Ripple Current | Case Size | Ripple Current |
| 56 | 566 | | | | | | | 20 x 25 | 0.37 |
| 68 | 686 | | | | | 20 x 25 | 0.41 | 20 x 30 22 x 25 | 0.44 0.45 |
| 82 | 826 | | | 20 x 25 | 0.39 | 20 x 30 | 0.45 | 20 x 30 22 x 30 | 0.50 0.52 |
| 100 | 107 | | | 20 x 30 | 0.45 | 20 x 30 22 x 25 | 0.51 0.53 | 20 x 35 22 x 30 25 x 25 | 0.56 0.58 0.57 |
| 120 | 127 | | | 20 x 30 22 x 25 | 0.54 0.56 | 20 x 35 22 x 30 25 x 25 | 0.59 0.61 0.62 | 20 x 40 22 x 35 25 x 30 | 0.68 0.68 0.68 |
| 150 | 157 | 20 x 25 | 0.71 | 20 x 35 22 x 30 25 x 25 | 0.64 0.66 0.65 | 20 x 40 22 x 35 25 x 30 | 0.70 0.73 0.73 | 22 x 40 25 x 30 30 x 25 | 0.79 0.78 0.75 |
| 180 | 187 | 20 x 30 22 x 25 | 0.82 0.84 | 20 x 40 22 x 35 25 x 30 | 0.75 0.78 0.71 | 22 x 40 25 x 30 30 x 25 | 0.83 0.80 0.81 | 22 x 45 25 x 35 30 x 30 | 0.89 0.86 0.88 |
| 220 | 227 | 20 x 35 22 x 30 25 x 25 | 0.95 0.97 0.99 | 22 x 40 25 x 30 30 x 25 | 0.89 0.85 0.83 | 22 x 45 25 x 35 30 x 30 | 0.94 0.92 0.98 | 22 x 50 25 x 40 30 x 30 | 1.01 1.00 1.00 |
| 270 | 277 | 20 x 40 22 x 35 25 x 30 | 1.08 1.11 1.15 | 22 x 45 25 x 35 30 x 30 | 1.01 0.98 1.01 | 22 x 50 25 x 40 30 x 30 | 1.07 1.05 1.03 | 25 x 45 30 x 40 35 x 30 | 1.13 1.14 1.10 |
| 330 | 337 | 22 x 40 25 x 30 30 x 25 | 1.26 1.26 1.31 | 22 x 50 25 x 40 30 x 35 | 1.14 1.12 1.21 | 25 x 45 30 x 35 35 x 30 | 1.24 1.24 1.18 | 30 x 45 35 x 35 | 1.31 1.32 |
| 390 | 397 | 22 x 45 25 x 35 30 x 30 | 1.41 1.42 1.50 | 25 x 45 30 x 35 35 x 30 | 1.31 1.30 1.23 | 25 x 50 30 x 40 35 x 35 | 1.38 1.39 1.39 | 30 x 50 35 x 40 | 1.48 1.48 |
| 470 | 477 | 22 x 50 25 x 40 30 x 30 | 1.58 1.61 1.61 | 30 x 40 35 x 35 | 1.53 1.47 | 30 x 45 35 x 35 | 1.57 1.50 | 35 x 45 | 1.76 |
| 560 | 567 | 25 x 45 30 x 35 | 1.80 1.84 | 30 x 45 35 x 40 | 1.65 1.66 | 30 x 50 35 x 40 | 1.75 1.69 | 35 x 50 | 1.95 |
| 680 | 687 | 25 x 50 30 x 40 35 x 30 | 2.03 2.09 1.96 | 35 x 45 | 1.96 | 35 x 45 | 1.96 | | |
| 820 | 827 | 30 x 45 35 x 35 | 2.35 2.26 | 35 x 50 | 2.19 | | | | |
| 1000 | 108 | 30 x 50 35 x 40 | 2.64 2.57 | | | | | | |
| 1200 | 128 | 35 x 45 | 2.88 | | | | | | |

Maximum Allowable Ripple Current (Arms) at 105°C 120Hz

Case Size φD x L (mm)

Specifications are subject to change without notice. Should a safety or technical concern arise regarding the product, please be sure to contact our sales offices or agents immediately.

STANDARD RATINGS

| Voltage (Code) | | 400V (2G) | | 420V (2M) | | 450V (2W) | | 500V (2H) | |
|----------------|------|-----------|----------------|-----------|----------------|-----------|----------------|-----------|----------------|
| Cap. (µF) | Code | Case Size | Ripple Current | Case Size | Ripple Current | Case Size | Ripple Current | Case Size | Ripple Current |
| 39 | 396 | | | | | | | 22 x 30 | 0.35 |
| 47 | 476 | | | | | 20 x 25 | 0.36 | 22 x 35 | 0.41 |
| 56 | 566 | 20 x 25 | 0.40 | 20 x 25 | 0.40 | 20 x 30 | 0.41 | 22 x 40 | 0.47 |
| | | | | | | 22 x 25 | 0.42 | | |
| 68 | 686 | 20 x 30 | 0.48 | 20 x 30 | 0.48 | 20 x 35 | 0.47 | 22 x 45 | 0.54 |
| | | 22 x 25 | 0.49 | 22 x 25 | 0.50 | 22 x 30 | 0.50 | | |
| 82 | 826 | 20 x 30 | 0.54 | 20 x 35 | 0.53 | 20 x 40 | 0.53 | 25 x 40 | 0.62 |
| | | 22 x 30 | 0.56 | 22 x 30 | 0.56 | 22 x 35 | 0.56 | | |
| 100 | 107 | 20 x 35 | 0.60 | 20 x 35 | 0.58 | 22 x 40 | 0.64 | 25 x 45 | 0.67 |
| | | 22 x 30 | 0.62 | 22 x 30 | 0.63 | 25 x 30 | 0.63 | | |
| | | 25 x 25 | 0.61 | 25 x 25 | 0.63 | 30 x 25 | 0.67 | | |
| 120 | 127 | 20 x 40 | 0.71 | 20 x 45 | 0.71 | 22 x 45 | 0.72 | 25 x 50 | 0.77 |
| | | 22 x 35 | 0.73 | 22 x 35 | 0.73 | 25 x 35 | 0.71 | 35 x 30 | 0.72 |
| | | 25 x 30 | 0.73 | 25 x 30 | 0.72 | 30 x 30 | 0.77 | | |
| 150 | 157 | 22 x 40 | 0.85 | 22 x 45 | 0.86 | 22 x 50 | 0.80 | 30 x 40 | 0.82 |
| | | 25 x 35 | 0.85 | 25 x 35 | 0.83 | 25 x 40 | 0.82 | | |
| | | 30 x 25 | 0.79 | 30 x 25 | 0.83 | 30 x 30 | 0.85 | | |
| 180 | 187 | 22 x 45 | 0.95 | 22 x 50 | 1.02 | 25 x 45 | 0.93 | 30 x 50 | 1.01 |
| | | 25 x 35 | 0.92 | 25 x 40 | 0.94 | 30 x 35 | 0.97 | | |
| | | 30 x 30 | 0.95 | 30 x 30 | 0.95 | | | | |
| 220 | 227 | 22 x 50 | 1.08 | 25 x 45 | 1.13 | 25 x 50 | 1.05 | 35 x 45 | 1.12 |
| | | 25 x 40 | 1.05 | 30 x 35 | 1.09 | 30 x 40 | 1.10 | | |
| | | 30 x 35 | 1.24 | 35 x 30 | 1.05 | 35 x 30 | 1.01 | | |
| 270 | 277 | 25 x 50 | 1.29 | 25 x 50 | 1.37 | 30 x 45 | 1.25 | 35 x 50 | 1.29 |
| | | 30 x 40 | 1.30 | 30 x 40 | 1.25 | 35 x 35 | 1.26 | | |
| | | 35 x 30 | 1.18 | 35 x 35 | 1.25 | | | | |
| 330 | 337 | 30 x 45 | 1.47 | 30 x 45 | 1.49 | 30 x 50 | 1.42 | | |
| | | 35 x 35 | 1.41 | 35 x 35 | 1.42 | 35 x 40 | 1.44 | | |
| 390 | 397 | 30 x 50 | 1.64 | 30 x 50 | 1.67 | 35 x 45 | 1.61 | | |
| | | 35 x 40 | 1.59 | 35 x 40 | 1.61 | | | | |
| 470 | 477 | 35 x 45 | 1.87 | 35 x 45 | 1.86 | 35 x 50 | 1.80 | | |
| 560 | 567 | 35 x 50 | 2.09 | | | | | | |

Maximum Allowable Ripple Current (Arms) at 105°C 120Hz

Case Size ϕ D x L (mm)

Specifications are subject to change without notice. Should a safety or technical concern arise regarding the product, please be sure to contact our sales offices or agents immediately.

FEATURES

- One rank smaller case sized than HP series.
- Suited for equipment down sizing.



SPECIFICATIONS

| Item | Performance Characteristics | |
|---------------------------------|--|---|
| Operating Temperature Range | -40 to +105°C | -25 to +105°C |
| Rated Working Voltage Range | 160 to 250V | 400 to 450V |
| Nominal Capacitance Range | 100 to 3300µF | |
| Capacitance Tolerance | ±20% at 120Hz, +20°C | |
| Leakage Current | I ≤ 3√CV (µA) after 5 minutes application of rated working voltage at +20°C | |
| tan δ (120Hz, +20°C) | Working Voltage (V) | 160 180 200 220 250 400 420 450 |
| | tan δ (max.) | 0.15 0.15 0.15 0.15 0.15 0.15 0.15 0.20 |
| Low Temperature Characteristics | Impedance ratio max. at 120Hz | |
| | Working Voltage (V) | 160~250 400~450 |
| | Z-25°C / Z+20°C | 4 8 |
| | Z-40°C / Z+20°C | 15 - |
| High Temperature Loading | Test time : 2,000 hours | Post test requirements at +20°C |
| | Test temperature : +105°C | Leakage current : ≤Initial specified value |
| | Test conditions : Rated DC working voltage with rated ripple current | Cap. change : within ±20% of the initial measured value |
| | | tan δ : ≤200% of the initial specified value |
| Shelf Life | At +105°C no voltage applied after 1,000 hours and then being stabilized at +20°C the capacitors shall meet the following limits | |
| | Leakage current : ≤Initial specified value | |
| | Cap. change : within ±15% of the initial measured value | |
| | tan δ : ≤150% of the initial specified value | |
| Industrial Standard | JIS C - 5101-4 (IEC 60384-4) | |

RIPPLE CURRENT MULTIPLIER

Frequency Coefficient

| Coefficient | Freq. (Hz) | | | |
|---------------|------------|------|------|---------|
| Rated Voltage | 60 | 120 | 1k | 10k~50k |
| 160~250V | 0.85 | 1.00 | 1.32 | 1.45 |
| 400~450V | 0.82 | 1.00 | 1.30 | 1.41 |

PART NUMBER SYSTEM (EXAMPLE : 250V 560µF)

| 1 | 2 3 | 4 5 6 | 7 | 8 9 | 10 | 11 12 | 13 14 |
|---|-----|-------|---|-----|----|-------|-------|
| E | GP | 567 | M | 2 E | O | 3 5 | S W |

Type (Terminal Code)
 Case Length (35mm)
 Diameter (25mm)
 Voltage (250V)
 Tolerance (±20%)
 Capacitance (560µF)
 Series
 E-CAP

STANDARD RATINGS

| Voltage (Code) | | 160V (2C) | | 180V (2P) | | 200V (2D) | | 220V (2N) | |
|----------------|------|-----------|----------------|-----------|----------------|-----------|----------------|-----------|----------------|
| Cap. (µF) | Code | Case Size | Ripple Current | Case Size | Ripple Current | Case Size | Ripple Current | Case Size | Ripple Current |
| 330 | 337 | | | | | | | 22 x 25 | 1.26 |
| 390 | 397 | | | | | | | 22 x 30 | 1.34 |
| 470 | 477 | | | 22 x 25 | 1.30 | 22 x 25 | 1.20 | 22 x 35 | 1.48 |
| | | | | | | | | 25 x 25 | 1.40 |
| 560 | 567 | 22 x 25 | 1.40 | 22 x 30 | 1.50 | 22 x 30 | 1.48 | 22 x 35 | 1.45 |
| | | | | | | 25 x 25 | 1.48 | 25 x 30 | 1.45 |
| 680 | 687 | 22 x 30 | 1.50 | 22 x 35 | 1.70 | 22 x 35 | 1.60 | 22 x 40 | 1.65 |
| | | 25 x 25 | 1.70 | 25 x 30 | 1.70 | 25 x 30 | 1.60 | 25 x 35 | 1.78 |
| 820 | 827 | | | 22 x 40 | 2.00 | 22 x 40 | 1.75 | 30 x 25 | 1.65 |
| | | | | 25 x 35 | 2.00 | 25 x 35 | 1.75 | 22 x 50 | 1.93 |
| | | 25 x 30 | 2.00 | 30 x 25 | 2.00 | 30 x 25 | 1.75 | 25 x 40 | 1.93 |
| 1000 | 108 | 22 x 40 | 2.10 | 22 x 45 | 2.10 | 22 x 45 | 2.04 | 30 x 30 | 1.85 |
| | | 25 x 35 | 2.20 | 25 x 35 | 2.05 | 25 x 40 | 2.04 | 35 x 25 | 1.93 |
| | | 30 x 25 | 2.20 | 30 x 30 | 2.20 | 30 x 30 | 2.04 | 25 x 45 | 2.15 |
| 1200 | 128 | 25 x 40 | 2.30 | 22 x 50 | 2.15 | 25 x 45 | 2.30 | 30 x 35 | 2.33 |
| | | | | 25 x 40 | 2.15 | 30 x 35 | 2.30 | 35 x 30 | 2.50 |
| | | 30 x 30 | 2.30 | 30 x 35 | 2.30 | 35 x 25 | 2.30 | 30 x 40 | 2.50 |
| 1500 | 158 | 35 x 25 | 2.30 | 35 x 25 | 2.15 | 35 x 25 | 2.30 | 35 x 30 | 2.35 |
| | | 25 x 45 | 2.50 | 25 x 50 | 2.40 | 25 x 50 | 2.57 | 30 x 45 | 2.55 |
| | | 30 x 35 | 2.50 | 30 x 40 | 2.50 | 30 x 40 | 2.57 | 30 x 45 | 2.55 |
| 1800 | 188 | 35 x 30 | 2.50 | 35 x 30 | 2.35 | 35 x 30 | 2.57 | 35 x 35 | 2.50 |
| | | 30 x 40 | 2.70 | 30 x 45 | 2.70 | 30 x 45 | 2.68 | 35 x 40 | 2.70 |
| | | 35 x 30 | 2.55 | 35 x 35 | 2.70 | 35 x 35 | 2.68 | 35 x 40 | 2.70 |
| 2200 | 228 | 30 x 45 | 2.90 | 30 x 50 | 2.90 | 30 x 50 | 2.92 | 35 x 50 | 2.95 |
| | | 35 x 35 | 2.90 | 35 x 40 | 2.90 | 35 x 40 | 2.92 | | |
| 2700 | 278 | 35 x 40 | 3.00 | 35 x 45 | 3.00 | 35 x 45 | 3.27 | | |
| 3300 | 338 | 35 x 45 | 3.10 | 35 x 50 | 3.10 | | | | |

Maximum Allowable Ripple Current (Arms) at 105°C 120Hz

Case Size Φ D x L (mm)

Specifications are subject to change without notice. Should a safety or technical concern arise regarding the product, please be sure to contact our sales offices or agents immediately.

STANDARD RATINGS

| Voltage (Code) | | 250V (2E) | | 400V (2G) | | 420V (2M) | | 450V (2W) | |
|----------------|------|-----------|----------------|-----------|----------------|-----------|----------------|-----------|----------------|
| Cap. (μF) | Code | Case Size | Ripple Current | Case Size | Ripple Current | Case Size | Ripple Current | Case Size | Ripple Current |
| 100 | 107 | | | | | | | 22 x 25 | 0.64 |
| 120 | 127 | | | 22 x 25 | 0.68 | 22 x 30 | 0.81 | 22 x 30 | 0.69 |
| | | | | | | | | 25 x 25 | 0.69 |
| 150 | 157 | | | | | 22 x 35 | 0.84 | 22 x 35 | 0.72 |
| | | | | | | 25 x 25 | 0.82 | 25 x 30 | 0.79 |
| 180 | 187 | | | 22 x 30 | 0.73 | 22 x 35 | 0.85 | 22 x 40 | 0.79 |
| | | | | 25 x 25 | 0.73 | 25 x 30 | 0.91 | 25 x 30 | 0.79 |
| 220 | 227 | | | 22 x 35 | 0.85 | 22 x 40 | 0.95 | 22 x 45 | 0.87 |
| | | | | 25 x 30 | 0.85 | 25 x 35 | 1.05 | 25 x 35 | 0.87 |
| 270 | 277 | | | 30 x 25 | 0.95 | 30 x 25 | 0.95 | 30 x 30 | 0.79 |
| | | | | 22 x 40 | 1.00 | 22 x 50 | 1.15 | 25 x 50 | 1.20 |
| | | | | 25 x 35 | 1.00 | 25 x 40 | 1.25 | 30 x 35 | 1.20 |
| 330 | 337 | | | 30 x 25 | 1.00 | 30 x 30 | 1.25 | 35 x 35 | 1.20 |
| | | | | 22 x 50 | 1.15 | 25 x 45 | 1.35 | 25 x 50 | 1.20 |
| | | | | 25 x 40 | 1.15 | 30 x 35 | 1.42 | 30 x 35 | 1.20 |
| | | | | 30 x 30 | 1.15 | 35 x 30 | 1.42 | 35 x 30 | 1.20 |
| 390 | 397 | 22 x 30 | 1.20 | 25 x 45 | 1.40 | 25 x 50 | 1.45 | 30 x 40 | 1.38 |
| | | 25 x 25 | 1.20 | 30 x 35 | 1.40 | 30 x 40 | 1.61 | 35 x 35 | 1.38 |
| | | | | 35 x 30 | 1.55 | 35 x 30 | 1.45 | | |
| 470 | 477 | 22 x 35 | 1.30 | 25 x 50 | 1.55 | 30 x 45 | 1.86 | 30 x 45 | 1.55 |
| | | 25 x 30 | 1.30 | 30 x 40 | 1.55 | 35 x 35 | 1.70 | 35 x 40 | 1.55 |
| | | | | 35 x 30 | 1.55 | | | | |
| 560 | 567 | 22 x 40 | 1.40 | 30 x 45 | 1.63 | | | | |
| | | 25 x 35 | 1.50 | | | 35 x 40 | 1.90 | 35 x 45 | 1.70 |
| | | 30 x 25 | 1.40 | 35 x 35 | 1.63 | | | | |
| 680 | 687 | 22 x 45 | 1.50 | 30 x 50 | 1.80 | | | | |
| | | 25 x 40 | 1.70 | | | 35 x 45 | 2.05 | 35 x 50 | 1.91 |
| | | 30 x 30 | 1.70 | 35 x 40 | 1.80 | | | | |
| 820 | 827 | 25 x 45 | 2.00 | | | | | | |
| | | 30 x 35 | 2.00 | 35 x 45 | 2.00 | | | | |
| | | 35 x 30 | 2.00 | | | | | | |
| 1000 | 108 | 25 x 50 | 2.20 | | | | | | |
| | | 30 x 40 | 2.20 | 35 x 50 | 2.14 | | | | |
| | | 35 x 30 | 2.00 | | | | | | |
| 1200 | 128 | 30 x 45 | 2.30 | | | | | | |
| | | 35 x 35 | 2.20 | | | | | | |
| 1500 | 158 | 30 x 50 | 2.30 | | | | | | |
| | | 35 x 40 | 2.30 | | | | | | |
| 1800 | 188 | 35 x 45 | 2.50 | | | | | | |

Maximum Allowable Ripple Current (Arms) at 105°C 120Hz

Case Size φD x L (mm)

Specifications are subject to change without notice. Should a safety or technical concern arise regarding the product, please be sure to contact our sales offices or agents immediately.

CASE SIZE TABLE

O-Type



Unit : mm

D-Type



Unit : mm



FEATURES

- Small case size, high rated voltage, capacitance and ripple current, stable and reliable performance, forming complete sets of unclear electric station.
- Suitable for use in electronic and industrial equipments such as computer, programming control exchanger for power supplies filtering and energy storing.

SPECIFICATIONS

| Item | Performance Characteristics | |
|---------------------------------|---|---|
| Operating Temperature Range | -40 to +85°C | -25 to +85°C |
| Rated Working Voltage Range | 10 to 100V | 160 to 630V |
| Nominal Capacitance Range | 100 to 680000μF | |
| Capacitance Tolerance | ±20% at 120Hz, +20°C | |
| Leakage Current | I ≤ 0.02CV (μA) or 5 (mA) whichever is smaller measured after 5 minutes application of rated working voltage at +20°C | |
| tan δ (120Hz, +20°C) | The values shown in the STANDARD RATINGS tables | |
| Low Temperature Characteristics | Impedance ratio max. at 120Hz | |
| | Working Voltage (V) | 10~100 160~630 |
| | Z-25°C / Z+20°C | — 8 |
| | Z-40°C / Z+20°C | 15 — |
| High Temperature Loading | Test time : 2,000 hours | Post test requirements at +20°C |
| | Test temperature : +85°C | Leakage current : ≤ Initial specified value |
| | Test conditions : Rated DC working voltage with rated ripple current | Cap. change : within ±20% of the initial measured value |
| | | tan δ : ≤ 200% of the initial specified value |
| Shelf Life | At +85°C no voltage applied after 1,000 hours and then being stabilized at +20°C the capacitors shall meet the following limits | |
| | Leakage current : ≤ Initial specified value | |
| | Cap. change : within ±20% of the initial measured value | |
| | tan δ : ≤ 175% of the initial specified value | |
| Industrial Standard | JIS C - 5101-4 (IEC 60384-4) | |

RIPPLE CURRENT MULTIPLIER

Frequency Coefficient

| Coefficient | Freq. (Hz) | | | | |
|---------------|------------|------|------|------|------|
| | 50 | 120 | 300 | 1k | 10k~ |
| Rated Voltage | | | | | |
| <160V | 0.80 | 1.00 | 1.08 | 1.15 | 1.15 |
| ≥160V | 0.80 | 1.00 | 1.08 | 1.15 | 1.20 |

PART NUMBER SYSTEM (EXAMPLE : 160V 6800μF)

| 1 | 2 3 | 4 5 6 | 7 | 8 9 | 10 | 11 12 | 13 14 |
|---|-----|-------|---|-----|----|-------|-------|
| E | WR | 688 | M | 2C | S | 1L | OO |

Type (Terminal Code)
 Case Length (100mm)
 Diameter (51mm)
 Voltage (160V)
 Tolerance (±20%)
 Capacitance (6800μF)
 Series
 E-CAP

CASE SIZE TABLE



Dimensions of mounting bracket

| Voltage (Code) | | 3 - Leg | | | | 2 - Leg | | | | |
|----------------|----------|---------|------|------|------|---------|------|------|------|-----|
| Symbol | ϕD | 51 | 63.5 | 76 | 90 | 35 | 51 | 63.5 | 76 | 90 |
| P | | 32.5 | 38.1 | 44.5 | 50.8 | 24 | 33.2 | 40.5 | 46.5 | 53 |
| A | | 38.5 | 43 | 49.2 | 58.5 | 29 | 40 | 46.5 | 53 | 59 |
| T | | 7.5 | 8.0 | 7.0 | 8.0 | 6.0 | 6.0 | 7.0 | 6.0 | 6.0 |
| S | | 5.0 | 5.0 | 5.0 | 5.0 | 3.5 | 4.5 | 4.5 | 4.5 | 4.5 |
| U | | 12 | 14 | 14 | 18 | 10 | 14 | 14 | 14 | 14 |
| θ° | | 60 | 60 | 60 | 60 | 30 | 30 | 30 | 30 | 30 |
| H | | 20 | 25 | 30 | 35 | 15 | 25 | 35 | 35 | 35 |
| h | | 15 | 20 | 24 | 25 | 10 | 15 | 20 | 20 | 20 |

STANDARD RATINGS

| Voltage (Code) | | 10V (1A) | | | 16V (1C) | | | 25V (1E) | | |
|----------------|------|------------|-------|----------------|------------|-------|----------------|------------|-------|----------------|
| SV | | 13 | | | 20 | | | 32 | | |
| Cap. (μF) | Code | Case Size | tan δ | Ripple Current | Case Size | tan δ | Ripple Current | Case Size | tan δ | Ripple Current |
| 18000 | 189 | | | | | | | 35 x 50 | 0.35 | 4.0 |
| 27000 | 279 | | | | 35 x 50 | 0.45 | 4.2 | | | |
| 39000 | 399 | 35 x 50 | 0.60 | 4.7 | | | | 35 x 80 | 0.40 | 6.2 |
| 47000 | 479 | | | | | | | 35 x 100 | 0.40 | 7.4 |
| 56000 | 569 | | | | 35 x 80 | 0.60 | 6.5 | 35 x 120 | 0.45 | 8.3 |
| 82000 | 829 | 35 x 80 | 0.60 | 7.0 | 35 x 100 | 0.70 | 8.0 | 51 x 80 | 0.50 | 9.7 |
| 100000 | 10T | 35 x 100 | 0.70 | 8.0 | 35 x 120 | 0.70 | 9.6 | 51 x 100 | 0.60 | 10.8 |
| 120000 | 12T | 35 x 120 | 0.70 | 9.4 | 51 x 80 | 0.80 | 9.6 | 51 x 120 | 0.60 | 12.0 |
| 150000 | 15T | 51 x 80 | 0.90 | 9.8 | 51 x 100 | 0.90 | 11.2 | | | |
| 180000 | 18T | | | | | | | 63.5 x 100 | 0.75 | 14.7 |
| 220000 | 22T | 51 x 100 | 1.00 | 10.3 | 51 x 120 | 1.00 | 14.2 | 63.5 x 100 | 0.80 | 15.0 |
| 270000 | 27T | 51 x 120 | 1.20 | 12.8 | 63.5 x 100 | 1.20 | 15.3 | 76 x 100 | 0.90 | 18.3 |
| 330000 | 33T | | | | 63.5 x 120 | 1.30 | 17.1 | 76 x 120 | 1.00 | 20.7 |
| 390000 | 39T | 63.5 x 100 | 1.50 | 15.3 | 76 x 100 | 1.60 | 18.0 | 76 x 140 | 1.20 | 22.1 |
| 470000 | 47T | 63.5 x 120 | 2.00 | 16.0 | 76 x 100 | 1.80 | 19.3 | | | |
| 560000 | 56T | 76 x 120 | 2.50 | 17.3 | 76 x 140 | 2.00 | 20.7 | 90 x 140 | 1.50 | 25.8 |
| 680000 | 68T | 76 x 120 | 3.00 | 18.7 | | | | | | |

Maximum Allowable Ripple Current (Arms) at 85°C 120Hz
tan δ at 20°C 120Hz

Case Size ΦD x L (mm)

| Voltage (Code) | | 35V (1V) | | | 50V (1H) | | | 63V (1J) | | |
|----------------|------|------------|-------|----------------|------------|-------|----------------|------------|-------|----------------|
| SV | | 44 | | | 63 | | | 79 | | |
| Cap. (μF) | Code | Case Size | tan δ | Ripple Current | Case Size | tan δ | Ripple Current | Case Size | tan δ | Ripple Current |
| 5600 | 568 | | | | | | | 35 x 50 | 0.20 | 3.0 |
| 10000 | 109 | | | | 35 x 50 | 0.25 | 3.9 | 35 x 80 | 0.25 | 4.0 |
| 15000 | 159 | 35 x 50 | 0.30 | 3.9 | | | | 35 x 100 | 0.25 | 5.3 |
| 18000 | 189 | | | | 35 x 80 | 0.25 | 5.2 | 35 x 120 | 0.25 | 6.2 |
| 22000 | 229 | | | | 35 x 100 | 0.30 | 5.7 | 51 x 80 | 0.30 | 6.5 |
| 27000 | 279 | | | | 35 x 120 | 0.35 | 6.6 | | | |
| 33000 | 339 | 35 x 80 | 0.40 | 6.0 | | | | 51 x 100 | 0.35 | 8.1 |
| 39000 | 399 | 35 x 100 | 0.40 | 6.7 | 51 x 80 | 0.40 | 7.4 | 51 x 120 | 0.35 | 9.5 |
| 47000 | 479 | 35 x 120 | 0.45 | 8.0 | | | | 63.5 x 100 | 0.40 | 10.2 |
| 56000 | 569 | | | | 51 x 100 | 0.40 | 9.8 | | | |
| 68000 | 689 | 51 x 80 | 0.50 | 8.5 | 51 x 120 | 0.45 | 11.1 | 63.5 x 120 | 0.45 | 12.7 |
| 82000 | 829 | 51 x 100 | 0.55 | 10.3 | 63.5 x 100 | 0.50 | 12.2 | | | |
| 100000 | 10T | 51 x 120 | 0.60 | 11.3 | | | | 76 x 120 | 0.45 | 16.7 |
| 120000 | 12T | 51 x 120 | 0.60 | 12.8 | 63.5 x 120 | 0.50 | 15.0 | 76 x 140 | 0.50 | 19.0 |
| 150000 | 15T | 63.5 x 100 | 0.70 | 13.2 | 76 x 115 | 0.60 | 17.7 | 90 x 140 | 0.55 | 22.0 |
| 180000 | 18T | 63.5 x 120 | 0.70 | 15.3 | 76 x 120 | 0.60 | 18.1 | | | |
| 220000 | 22T | 76 x 100 | 0.75 | 17.8 | 76 x 140 | 0.70 | 19.5 | | | |
| 270000 | 27T | 76 x 120 | 0.80 | 18.4 | 90 x 140 | 0.80 | 23.2 | | | |
| 330000 | 33T | 76 x 140 | 0.90 | 22.0 | | | | | | |
| 470000 | 47T | 90 x 140 | 1.00 | 28.0 | | | | | | |

Maximum Allowable Ripple Current (Arms) at 85°C 120Hz
tan δ at 20°C 120Hz

Case Size ΦD x L (mm)

Specifications are subject to change without notice. Should a safety or technical concern arise regarding the product, please be sure to contact our sales offices or agents immediately.

STANDARD RATINGS

| Voltage (Code) | | 80V (1K) | | | 100V (2A) | | | 160V (2C) | | |
|----------------|------|------------|-------|----------------|------------|-------|----------------|------------|-------|----------------|
| SV | | 100 | | | 125 | | | 200 | | |
| Cap. (μF) | Code | Case Size | tan δ | Ripple Current | Case Size | tan δ | Ripple Current | Case Size | tan δ | Ripple Current |
| 1200 | 128 | | | | | | | 35 x 50 | 0.15 | 2.0 |
| 2200 | 228 | | | | 35 x 50 | 0.10 | 2.1 | 35 x 80 | 0.15 | 3.4 |
| 2700 | 278 | | | | | | | 35 x 100 | 0.15 | 3.7 |
| 3300 | 338 | 35 x 50 | 0.15 | 2.5 | | | | 35 x 120 | 0.15 | 4.5 |
| 4700 | 478 | | | | 35 x 80 | 0.15 | 3.4 | 51 x 80 | 0.20 | 5.6 |
| 6800 | 688 | 35 x 80 | 0.20 | 3.7 | 35 x 100 | 0.15 | 4.2 | 51 x 100 | 0.20 | 7.5 |
| 8200 | 828 | | | | 35 x 120 | 0.15 | 5.0 | 51 x 120 | 0.20 | 8.1 |
| 10000 | 109 | 35 x 100 | 0.20 | 4.9 | 51 x 80 | 0.20 | 5.2 | 63.5 x 100 | 0.20 | 9.8 |
| 12000 | 129 | 35 x 120 | 0.20 | 5.4 | | | | 63.5 x 120 | 0.20 | 10.8 |
| 15000 | 159 | 51 x 80 | 0.25 | 6.0 | | | | 76 x 100 | 0.20 | 12.7 |
| 18000 | 189 | | | | 51 x 120 | 0.20 | 8.1 | 76 x 120 | 0.20 | 14.0 |
| 22000 | 229 | 51 x 100 | 0.30 | 7.1 | 63.5 x 100 | 0.25 | 8.6 | 76 x 130 | 0.20 | 16.6 |
| 27000 | 279 | 51 x 120 | 0.30 | 8.6 | 63.5 x 120 | 0.25 | 10.3 | 76 x 140 | 0.20 | 16.6 |
| 33000 | 339 | 63.5 x 100 | 0.35 | 9.3 | 76 x 100 | 0.25 | 11.1 | 90 x 140 | 0.25 | 18.9 |
| 39000 | 399 | | | | 76 x 120 | 0.25 | 12.4 | | | |
| 47000 | 479 | 63.5 x 120 | 0.35 | 12.0 | 76 x 140 | 0.25 | 14.3 | | | |
| 68000 | 689 | 76 x 120 | 0.35 | 15.4 | 90 x 140 | 0.30 | 18.0 | | | |
| 82000 | 829 | 76 x 140 | 0.35 | 18.1 | | | | | | |
| 100000 | 10T | 90 x 140 | 0.40 | 21.0 | | | | | | |

Maximum Allowable Ripple Current (Arms) at 85°C 120Hz
tan δ at 20°C 120Hz

Case Size ΦD x L (mm)

| Voltage (Code) | | 200V (2D) | | | 250V (2E) | | | 350V (2V) | | |
|----------------|------|------------|-------|----------------|------------|-------|----------------|------------|-------|----------------|
| SV | | 250 | | | 300 | | | 400 | | |
| Cap. (μF) | Code | Case Size | tan δ | Ripple Current | Case Size | tan δ | Ripple Current | Case Size | tan δ | Ripple Current |
| 390 | 397 | | | | | | | 35 x 50 | 0.25 | 1.9 |
| 560 | 567 | | | | 35 x 50 | 0.15 | 1.3 | | | |
| 680 | 687 | | | | | | | 35 x 80 | 0.25 | 2.9 |
| 820 | 827 | 35 x 50 | 0.15 | 1.6 | | | | | | |
| 1000 | 108 | | | | | | | 35 x 100 | 0.25 | 3.8 |
| 1200 | 128 | | | | 35 x 80 | 0.15 | 2.3 | 35 x 120 | 0.25 | 4.2 |
| 1500 | 158 | | | | 35 x 100 | 0.15 | 3.0 | 51 x 80 | 0.25 | 4.5 |
| 1800 | 188 | 35 x 80 | 0.15 | 2.8 | 35 x 120 | 0.15 | 3.3 | | | |
| 2200 | 228 | 35 x 100 | 0.15 | 3.6 | 51 x 80 | 0.15 | 3.7 | 51 x 90 | 0.25 | 5.8 |
| 2700 | 278 | 35 x 120 | 0.15 | 4.0 | | | | | | |
| 3300 | 338 | 51 x 80 | 0.15 | 4.5 | 51 x 100 | 0.15 | 5.1 | 51 x 130 | 0.25 | 8.3 |
| 3900 | 398 | | | | 51 x 120 | 0.15 | 5.9 | 63.5 x 110 | 0.25 | 9.2 |
| 4700 | 478 | 51 x 100 | 0.15 | 6.5 | 63.5 x 95 | 0.20 | 6.7 | 63.5 x 130 | 0.25 | 10.9 |
| 5600 | 568 | 51 x 120 | 0.15 | 7.6 | 63.5 x 100 | 0.20 | 6.9 | 76 x 90 | 0.25 | 10.3 |
| 6800 | 688 | | | | 63.5 x 120 | 0.20 | 8.7 | 76 x 115 | 0.25 | 11.7 |
| 8200 | 828 | 63.5 x 100 | 0.20 | 9.5 | | | | 76 x 130 | 0.25 | 14.0 |
| 10000 | 109 | 63.5 x 120 | 0.20 | 11.0 | 76 x 120 | 0.20 | 11.1 | 76 x 155 | 0.25 | 15.6 |
| 12000 | 129 | 76 x 100 | 0.20 | 11.5 | 76 x 150 | 0.20 | 12.2 | | | |
| 15000 | 159 | 76 x 120 | 0.20 | 12.8 | 76 x 140 | 0.20 | 13.0 | 90 x 150 | 0.25 | 20.0 |
| 18000 | 189 | 76 x 140 | 0.20 | 15.0 | 76 x 155 | 0.25 | 16.1 | | | |
| 22000 | 229 | 90 x 140 | 0.25 | 15.6 | 90 x 140 | 0.20 | 14.9 | | | |
| | | | | | 90 x 150 | 0.20 | 18.5 | | | |
| | | | | | 90 x 155 | 0.20 | 19.0 | | | |

Maximum Allowable Ripple Current (Arms) at 85°C 120Hz
tan δ at 20°C 120Hz

Case Size ΦD x L (mm)

Specifications are subject to change without notice. Should a safety or technical concern arise regarding the product, please be sure to contact our sales offices or agents immediately.

STANDARD RATINGS

| Voltage (Code) | | 400V (2G) | | | 450V (2W) | | | 500V (2H) | | |
|----------------|------|------------|-------|----------------|------------|-------|----------------|------------|-------|----------------|
| SV | | 450 | | | 500 | | | 550 | | |
| Cap. (μF) | Code | Case Size | tan δ | Ripple Current | Case Size | tan δ | Ripple Current | Case Size | tan δ | Ripple Current |
| 470 | 477 | | | | | | | 51 x 80 | 0.25 | 1.8 |
| 680 | 687 | | | | | | | 51 x 105 | 0.25 | 2.5 |
| 820 | 827 | | | | | | | 51 x 105 | 0.25 | 2.8 |
| 1000 | 108 | 51 x 80 | 0.25 | 3.4 | 51 x 80 | 0.25 | 3.5 | 51 x 115 | 0.25 | 3.2 |
| 1200 | 128 | 51 x 80 | 0.25 | 3.8 | 51 x 100 | 0.25 | 4.5 | | | |
| 1500 | 158 | 51 x 105 | 0.25 | 4.5 | 51 x 105 | 0.25 | 5.0 | 51 x 115 | 0.25 | 4.0 |
| 1800 | 188 | 51 x 105 | 0.25 | 5.2 | 51 x 115 | 0.25 | 5.6 | 63.5 x 115 | 0.25 | 4.8 |
| | | 63.5 x 95 | 0.25 | 6.4 | 51 x 130 | 0.25 | 6.5 | | | |
| 2200 | 228 | 51 x 100 | 0.25 | 5.6 | | | | 63.5 x 130 | 0.25 | 5.7 |
| | | 51 x 140 | 0.25 | 6.5 | 63.5 x 95 | 0.25 | 6.5 | | | |
| 2700 | 278 | 51 x 130 | 0.25 | 7.1 | 63.5 x 115 | 0.25 | 7.8 | 76 x 115 | 0.25 | 6.5 |
| 3300 | 338 | 63.5 x 115 | 0.25 | 8.5 | 63.5 x 130 | 0.25 | 9.1 | | | |
| | | | | | 76 x 115 | 0.25 | 9.0 | | | |
| 3900 | 398 | 63.5 x 130 | 0.25 | 9.7 | 63.5 x 160 | 0.25 | 9.5 | 76 x 130 | 0.25 | 8.4 |
| | | | | | 76 x 115 | 0.25 | 9.7 | | | |
| 4700 | 478 | 63.5 x 160 | 0.25 | 10.5 | 76 x 130 | 0.25 | 11.2 | | | |
| | | 76 x 105 | 0.25 | 10.3 | | | | | | |
| | | 76 x 115 | 0.25 | 10.7 | 90 x 120 | 0.25 | 11.5 | | | |
| 5600 | 568 | 63.5 x 190 | 0.25 | 12.0 | | | | | | |
| | | 76 x 115 | 0.25 | 11.5 | 76 x 155 | 0.25 | 13.3 | | | |
| | | 76 x 130 | 0.25 | 12.2 | | | | | | |
| 6800 | 688 | 76 x 150 | 0.25 | 14.4 | 76 x 155 | 0.25 | 14.4 | | | |
| | | 76 x 155 | 0.25 | 14.6 | 76 x 170 | 0.25 | 15.0 | | | |
| | | | | | 90 x 155 | 0.25 | 15.3 | | | |
| 8200 | 828 | 76 x 155 | 0.25 | 14.6 | | | | | | |
| | | 76 x 170 | 0.25 | 15.0 | 90 x 155 | 0.25 | 17.0 | | | |
| | | 90 x 150 | 0.25 | 16.5 | | | | | | |
| | | 90 x 155 | 0.25 | 16.8 | | | | | | |
| 10000 | 109 | 76 x 170 | 0.25 | 17.5 | | | | | | |
| | | 90 x 130 | 0.25 | 17.1 | 90 x 170 | 0.25 | 18.5 | | | |
| | | 90 x 150 | 0.25 | 18.2 | | | | | | |
| | | 90 x 155 | 0.25 | 18.5 | | | | | | |
| | | 90 x 160 | 0.25 | 18.7 | | | | | | |
| 12000 | 129 | 90 x 170 | 0.25 | 20.5 | 90 x 230 | 0.25 | 23.5 | | | |
| 15000 | 159 | 90 x 230 | 0.25 | 26.5 | | | | | | |

Maximum Allowable Ripple Current (Arms) at 85°C 120Hz
tan δ at 20°C 120Hz

Case Size ΦD x L (mm)

| Voltage (Code) | | 550V (25) | | | 600V (26) | | | 630V (2J) | | |
|----------------|------|------------|-------|----------------|------------|-------|----------------|------------|-------|----------------|
| SV | | 600 | | | 650 | | | 680 | | |
| Cap. (μF) | Code | Case Size | tan δ | Ripple Current | Case Size | tan δ | Ripple Current | Case Size | tan δ | Ripple Current |
| 100 | 107 | 35 x 50 | 0.25 | 0.6 | | | | | | |
| 180 | 187 | 35 x 80 | 0.25 | 1.0 | | | | | | |
| 270 | 277 | 35 x 100 | 0.25 | 1.3 | | | | | | |
| 330 | 337 | 35 x 120 | 0.25 | 1.6 | | | | | | |
| 390 | 397 | 51 x 80 | 0.25 | 1.7 | | | | | | |
| 560 | 567 | 51 x 100 | 0.25 | 2.1 | | | | | | |
| | | 63.5 x 120 | 0.25 | 2.5 | | | | | | |
| 680 | 687 | 51 x 130 | 0.25 | 2.7 | | | | | | |
| | | 63.5 x 130 | 0.25 | 3.0 | | | | | | |
| 820 | 827 | 51 x 130 | 0.25 | 3.1 | | | | | | |
| | | 63.5 x 100 | 0.25 | 3.5 | | | | | | |
| 1000 | 108 | | | | 63.5 x 120 | 0.30 | 5.3 | 63.5 x 130 | 0.30 | 5.9 |
| 1200 | 128 | 76 x 100 | 0.25 | 4.2 | 76 x 100 | 0.30 | 6.0 | 76 x 110 | 0.30 | 6.7 |
| 1500 | 158 | 76 x 100 | 0.25 | 4.6 | 76 x 120 | 0.30 | 7.3 | 76 x 130 | 0.30 | 8.1 |
| 1800 | 188 | 76 x 100 | 0.25 | 5.2 | 76 x 140 | 0.30 | 8.6 | 76 x 150 | 0.30 | 9.6 |
| 2200 | 228 | 76 x 110 | 0.25 | 5.9 | 90 x 120 | 0.30 | 9.6 | 90 x 130 | 0.30 | 10.7 |
| 2700 | 278 | | | | 90 x 140 | 0.30 | 11.3 | 90 x 150 | 0.30 | 12.6 |
| 3300 | 338 | 76 x 140 | 0.25 | 8.0 | 90 x 160 | 0.30 | 13.2 | 90 x 170 | 0.30 | 14.7 |
| 3900 | 398 | | | | 90 x 180 | 0.30 | 15.6 | 90 x 190 | 0.30 | 17.3 |

Maximum Allowable Ripple Current (Arms) at 85°C 120Hz
tan δ at 20°C 120Hz

Case Size ΦD x L (mm)

Specifications are subject to change without notice. Should a safety or technical concern arise regarding the product, please be sure to contact our sales offices or agents immediately.

FEATURES

- Load life of 2,000 hours application of ripple current at 85°C.
- Higher ripple current than WR series, high reliability type.
- Inverter-use.



SPECIFICATIONS

| Item | Performance Characteristics |
|---------------------------------|--|
| Operating Temperature Range | -25 to +85°C |
| Rated Working Voltage Range | 350 to 450V |
| Nominal Capacitance Range | 390 to 22000μF |
| Capacitance Tolerance | ±20% at 120Hz, +20°C |
| Leakage Current | I ≤ 0.02CV (μA) or 5 (mA) whichever is smaller measured after 5 minutes application of rated working voltage at +20°C |
| tan δ (120Hz, +20°C) | 0.25 |
| Low Temperature Characteristics | Impedance ratio max. at 120Hz |
| | Working Voltage (V) : 350~450 Z-25°C / Z+20°C : 8 |
| High Temperature Loading | Test time : 2,000 hours Test temperature : +85°C Test conditions : Rated DC working voltage with rated ripple current |
| | Post test requirements at +20°C Leakage current : ≤ Initial specified value Cap. change : within ±20% of the initial measured value tan δ : ≤ 200% of the initial specified value |
| Shelf Life | At +85°C no voltage applied after 1,000 hours and then being stabilized at +20°C the capacitors shall meet the following limits Leakage current : ≤ Initial specified value Cap. change : within ±20% of the initial measured value tan δ : ≤ 175% of the initial specified value |
| Industrial Standard | JIS C - 5101-4 (IEC 60384-4) |

RIPPLE CURRENT MULTIPLIER

Frequency Coefficient

| Coefficient | Freq. (Hz) | Rated Voltage | | | | |
|-------------|------------|---------------|------|------|------|------|
| | | 50 | 120 | 300 | 1k | 10k~ |
| <160V | | 0.80 | 1.00 | 1.08 | 1.15 | 1.15 |
| ≥160V | | 0.80 | 1.00 | 1.08 | 1.15 | 1.20 |

PART NUMBER SYSTEM (EXAMPLE : 350V 2200μF)

| 1 | 2 3 | 4 5 6 | 7 | 8 9 | 10 | 11 12 | 13 14 |
|---|-----|-------|---|-----|----|-------|-------|
| E | WI | 228 | M | 2V | S | 95 | O5 |

Type (Terminal Code)
 Case Length (95mm)
 Diameter (51mm)
 Voltage (350V)
 Tolerance (±20%)
 Capacitance (2200μF)
 Series
 E-CAP

CASE SIZE TABLE



Dimensions of mounting bracket

| Voltage (Code) | | 3-Leg | | | | 2-Leg | | | | |
|----------------|----|-------|------|------|------|-------|------|------|------|-----|
| Symbol | φD | 51 | 63.5 | 76 | 90 | 35 | 51 | 63.5 | 76 | 90 |
| P | | 32.5 | 38.1 | 44.5 | 50.8 | 24 | 33.2 | 40.5 | 46.5 | 53 |
| A | | 38.5 | 43 | 49.2 | 58.5 | 29 | 40 | 46.5 | 53 | 59 |
| T | | 7.5 | 8.0 | 7.0 | 8.0 | 6.0 | 6.0 | 7.0 | 6.0 | 6.0 |
| S | | 5.0 | 5.0 | 5.0 | 5.0 | 3.5 | 4.5 | 4.5 | 4.5 | 4.5 |
| U | | 12 | 14 | 14 | 18 | 10 | 14 | 14 | 14 | 14 |
| θ° | | 60 | 60 | 60 | 60 | 30 | 30 | 30 | 30 | 30 |
| H | | 20 | 25 | 30 | 35 | 15 | 25 | 35 | 35 | 35 |
| h | | 15 | 20 | 24 | 25 | 10 | 15 | 20 | 20 | 20 |

STANDARD RATINGS

| Voltage (Code) | | 350V (2V) | | 400V (2G) | | 450V (2W) | |
|----------------|------|------------|----------------|------------|----------------|------------|----------------|
| SV | | 400 | | 450 | | 500 | |
| Cap. (μF) | Code | Case Size | Ripple Current | Case Size | Ripple Current | Case Size | Ripple Current |
| 390 | 397 | 35 x 50 | 1.9 | | | | |
| 560 | 567 | | | 35 x 80 | 2.8 | | |
| 680 | 687 | 35 x 80 | 3.1 | | | | |
| 820 | 827 | | | 35 x 100 | 3.8 | | |
| 1000 | 108 | 35 x 100 | 4.2 | 35 x 120 | 4.5 | 51 x 75 | 5.4 |
| 1200 | 128 | 35 x 120 | 4.8 | 51 x 75 | 4.9 | 51 x 95 | 6.6 |
| 1500 | 158 | 51 x 75 | 5.3 | | | 51 x 115 | 7.6 |
| 1800 | 188 | | | 51 x 95 | 6.4 | 51 x 130 | 8.3 |
| 2200 | 228 | 51 x 95 | 7.1 | 51 x 130 | 8.1 | 63.5 x 95 | 10.0 |
| 2700 | 278 | | | 63.5 x 96 | 8.9 | 63.5 x 115 | 11.7 |
| 3300 | 338 | 51 x 130 | 10.0 | 63.5 x 115 | 11.3 | 63.5 x 130 | 12.0 |
| 3900 | 398 | 63.5 x 115 | 11.7 | 63.5 x 130 | 12.3 | 76 x 115 | 13.3 |
| 4700 | 478 | 63.5 x 130 | 13.5 | 76 x 106 | 13.8 | 76 x 130 | 15.4 |
| | | | | 76 x 115 | 14.3 | | |
| 5600 | 568 | 76 x 115 | 15.5 | 76 x 130 | 16.5 | 76 x 155 | 18.2 |
| 6800 | 688 | 76 x 130 | 17.9 | 76 x 144 | 19.0 | 90 x 155 | 20.6 |
| | | | | 76 x 155 | 19.6 | | |
| 8200 | 828 | 76 x 155 | 20.4 | 90 x 155 | 22.0 | 90 x 155 | 22.1 |
| 10000 | 109 | 90 x 130 | 21.7 | 90 x 155 | 23.6 | 90 x 195 | 27.2 |
| 12000 | 129 | 90 x 155 | 24.7 | 90 x 195 | 27.5 | 90 x 235 | 32.1 |
| 15000 | 159 | 90 x 195 | 28.6 | 90 x 235 | 32.1 | | |
| 18000 | 189 | 90 x 235 | 34.1 | | | | |
| 22000 | 229 | | | 90 x 235 | 38.9 | | |

Maximum Allowable Ripple Current (Arms) at 85°C 120Hz

Case Size Φ D x L (mm)

Specifications are subject to change without notice. Should a safety or technical concern arise regarding the product, please be sure to contact our sales offices or agents immediately.

FEATURES

- Load life of 2,000 hours application of ripple current at 105°C.
- Suitable for use in electronic and industrial equipments such as computer, programming control exchanger for power supplies filtering and energy storing.



SPECIFICATIONS

| Item | Performance Characteristics | |
|---------------------------------|--|---|
| Operating Temperature Range | -40 to +105°C | -25 to +105°C |
| Rated Working Voltage Range | 10 to 100V | 160 to 500V |
| Nominal Capacitance Range | 180 to 680000μF | |
| Capacitance Tolerance | ±20% at 120Hz, +20°C | |
| Leakage Current | I ≤ 0.02CV (μA) or 5 (mA) whichever is smaller measured after 5 minutes application of rated working voltage at +20°C | |
| tan δ (120Hz, +20°C) | The values shown in the STANDARD RATINGS tables | |
| Low Temperature Characteristics | Impedance ratio max. at 120Hz | |
| | Working Voltage (V) | 10~100 160~500 |
| | Z-25°C / Z+20°C | - 8 |
| | Z-40°C / Z+20°C | 15 - |
| High Temperature Loading | Test time : 2,000 hours | Post test requirements at +20°C |
| | Test temperature : +105°C | Leakage current : ≤ Initial specified value |
| | Test conditions : Rated DC working voltage with rated ripple current | Cap. change : within ±20% of the initial measured value |
| | | tan δ : ≤ 200% of the initial specified value |
| Shelf Life | At +105°C no voltage applied after 1,000 hours and then being stabilized at +20°C the capacitors shall meet the following limits | |
| | Leakage current : ≤ Initial specified value | |
| | Cap. change : within ±20% of the initial measured value | |
| | tan δ : ≤ 200% of the initial specified value | |
| Industrial Standard | JIS C - 5101-4 (IEC 60384-4) | |

RIPPLE CURRENT MULTIPLIER

Frequency Coefficient

| Coefficient | Freq. (Hz) | Rated Voltage | | | | |
|-------------|------------|---------------|------|------|------|------|
| | | 50 | 120 | 300 | 1k | 10k~ |
| <160V | | 0.80 | 1.00 | 1.08 | 1.15 | 1.15 |
| ≥160V | | 0.80 | 1.00 | 1.08 | 1.15 | 1.20 |

PART NUMBER SYSTEM (EXAMPLE : 350V 2700μF)

| 1 | 2 3 | 4 5 6 | 7 | 8 9 | 10 | 11 12 | 13 14 |
|---|-----|-------|---|-----|----|-------|-------|
| E | WT | 278 | M | 2V | T | 1L | OO |

Type (Terminal Code)
 Case Length (100mm)
 Diameter (63.5mm)
 Voltage (350V)
 Tolerance (±20%)
 Capacitance (2700μF)
 Series
 E-CAP

CASE SIZE TABLE



Dimensions of mounting bracket

| Voltage (Code) | | 3 - Leg | | | | 2 - Leg | | | | |
|----------------|----------|---------|------|------|------|---------|------|------|------|-----|
| Symbol | ϕD | 51 | 63.5 | 76 | 90 | 35 | 51 | 63.5 | 76 | 90 |
| P | | 32.5 | 38.1 | 44.5 | 50.8 | 24 | 33.2 | 40.5 | 46.5 | 53 |
| A | | 38.5 | 43 | 49.2 | 58.5 | 29 | 40 | 46.5 | 53 | 59 |
| T | | 7.5 | 8.0 | 7.0 | 8.0 | 6.0 | 6.0 | 7.0 | 6.0 | 6.0 |
| S | | 5.0 | 5.0 | 5.0 | 5.0 | 3.5 | 4.5 | 4.5 | 4.5 | 4.5 |
| U | | 12 | 14 | 14 | 18 | 10 | 14 | 14 | 14 | 14 |
| θ° | | 60 | 60 | 60 | 60 | 30 | 30 | 30 | 30 | 30 |
| H | | 20 | 25 | 30 | 35 | 15 | 25 | 35 | 35 | 35 |
| h | | 15 | 20 | 24 | 25 | 10 | 15 | 20 | 20 | 20 |

STANDARD RATINGS

| Voltage (Code) | | 10V (1A) | | | 16V (1C) | | | 25V (1E) | | |
|----------------|------|------------|-------|----------------|------------|-------|----------------|------------|-------|----------------|
| SV | | 13 | | | 20 | | | 32 | | |
| Cap. (μF) | Code | Case Size | tan δ | Ripple Current | Case Size | tan δ | Ripple Current | Case Size | tan δ | Ripple Current |
| 12000 | 129 | | | | | | | 35 x 50 | 0.35 | 3.7 |
| 15000 | 159 | | | | | | | 35 x 50 | 0.35 | 4.1 |
| 18000 | 189 | | | | 35 x 50 | 0.40 | 4.2 | 35 x 60 | 0.35 | 4.8 |
| 22000 | 229 | | | | 35 x 50 | 0.40 | 4.7 | 35 x 60 | 0.35 | 5.3 |
| 27000 | 279 | 35 x 50 | 0.45 | 4.9 | 35 x 60 | 0.40 | 5.5 | 35 x 80 | 0.35 | 6.4 |
| 33000 | 339 | 35 x 50 | 0.50 | 5.1 | 35 x 60 | 0.45 | 5.7 | 35 x 80 | 0.40 | 6.7 |
| 39000 | 399 | 35 x 60 | 0.50 | 5.9 | 35 x 80 | 0.45 | 6.8 | 35 x 100 | 0.40 | 7.8 |
| 47000 | 479 | 35 x 80 | 0.50 | 7.1 | 35 x 80 | 0.50 | 7.1 | 35 x 120 | 0.40 | 9.3 |
| 56000 | 569 | 35 x 80 | 0.60 | 7.1 | 35 x 100 | 0.50 | 8.4 | 51 x 80 | 0.45 | 9.7 |
| 68000 | 689 | 35 x 100 | 0.60 | 8.5 | 35 x 100 | 0.55 | 8.8 | 51 x 100 | 0.45 | 11.2 |
| 82000 | 829 | 35 x 100 | 0.65 | 8.9 | 51 x 80 | 0.55 | 10.7 | 51 x 100 | 0.50 | 11.2 |
| 100000 | 10T | 35 x 120 | 0.65 | 10.7 | 51 x 80 | 0.65 | 10.8 | 51 x 120 | 0.50 | 14.8 |
| 120000 | 12T | 51 x 80 | 0.75 | 11.0 | 51 x 100 | 0.65 | 13.1 | 63.5 x 100 | 0.65 | 14.9 |
| 150000 | 15T | 51 x 100 | 0.80 | 13.2 | 51 x 120 | 0.70 | 15.3 | 63.5 x 120 | 0.65 | 17.9 |
| 180000 | 18T | 51 x 120 | 0.80 | 15.7 | 51 x 120 | 0.80 | 15.7 | 63.5 x 120 | 0.80 | 17.9 |
| 220000 | 22T | 51 x 120 | 0.85 | 16.8 | 63.5 x 120 | 0.85 | 19.2 | 76 x 120 | 0.85 | 21.3 |
| 270000 | 27T | 63.5 x 120 | 1.00 | 19.6 | 63.5 x 120 | 1.00 | 19.6 | 76 x 120 | 1.00 | 21.7 |
| 330000 | 33T | 63.5 x 120 | 1.20 | 19.7 | 76 x 120 | 1.30 | 21.1 | 76 x 140 | 1.20 | 23.4 |
| 390000 | 39T | 76 x 120 | 1.50 | 21.3 | 76 x 120 | 1.50 | 21.3 | 90 x 140 | 1.50 | 24.9 |
| 470000 | 47T | 76 x 120 | 1.80 | 21.4 | 76 x 140 | 1.60 | 24.2 | | | |
| 560000 | 56T | 76 x 140 | 2.00 | 23.6 | 90 x 140 | 2.00 | 28.1 | | | |
| 680000 | 68T | 90 x 140 | 2.40 | 26.0 | 90 x 140 | 2.40 | 28.5 | | | |

Maximum Allowable Ripple Current (Arms) at 105°C 120Hz
tan δ at 20°C 120Hz

Case Size ΦD x L (mm)

| Voltage (Code) | | 35V (1V) | | | 50V (1H) | | | 63V (1J) | | |
|----------------|------|------------|-------|----------------|------------|-------|----------------|------------|-------|----------------|
| SV | | 44 | | | 63 | | | 79 | | |
| Cap. (μF) | Code | Case Size | tan δ | Ripple Current | Case Size | tan δ | Ripple Current | Case Size | tan δ | Ripple Current |
| 2700 | 278 | | | | | | | 35 x 50 | 0.20 | 2.3 |
| 3300 | 338 | | | | | | | 35 x 50 | 0.20 | 2.5 |
| 3900 | 398 | | | | 35 x 50 | 0.20 | 2.8 | 35 x 50 | 0.20 | 2.8 |
| 4700 | 478 | | | | 35 x 50 | 0.20 | 3.1 | 35 x 50 | 0.20 | 3.1 |
| 5600 | 568 | | | | 35 x 50 | 0.20 | 3.3 | 35 x 60 | 0.20 | 3.5 |
| 6800 | 688 | | | | 35 x 50 | 0.25 | 3.3 | 35 x 60 | 0.20 | 3.9 |
| 8200 | 828 | 35 x 50 | 0.30 | 3.3 | 35 x 60 | 0.25 | 3.8 | 35 x 80 | 0.20 | 4.7 |
| 10000 | 109 | 35 x 50 | 0.30 | 3.6 | 35 x 80 | 0.25 | 4.6 | 35 x 80 | 0.25 | 4.7 |
| 12000 | 129 | 35 x 60 | 0.30 | 4.2 | 35 x 80 | 0.25 | 5.1 | 35 x 100 | 0.25 | 5.5 |
| 15000 | 159 | 35 x 60 | 0.30 | 4.7 | 35 x 80 | 0.25 | 5.7 | 35 x 120 | 0.25 | 6.6 |
| 18000 | 189 | 35 x 80 | 0.30 | 5.7 | 35 x 100 | 0.25 | 6.7 | 51 x 80 | 0.25 | 7.4 |
| 22000 | 229 | 35 x 80 | 0.30 | 6.3 | 35 x 120 | 0.25 | 8.1 | 51 x 100 | 0.25 | 9.0 |
| 27000 | 279 | 35 x 100 | 0.30 | 7.5 | 51 x 80 | 0.25 | 9.1 | 51 x 120 | 0.25 | 10.9 |
| 33000 | 339 | 35 x 120 | 0.30 | 9.0 | 51 x 100 | 0.25 | 11.1 | 51 x 120 | 0.25 | 12.0 |
| 39000 | 399 | 51 x 80 | 0.35 | 9.2 | 51 x 120 | 0.25 | 13.1 | 63.5 x 100 | 0.30 | 12.5 |
| 47000 | 479 | 51 x 100 | 0.35 | 11.2 | 51 x 120 | 0.30 | 13.9 | 63.5 x 120 | 0.30 | 14.9 |
| 56000 | 569 | 51 x 100 | 0.40 | 11.4 | 63.5 x 100 | 0.35 | 13.9 | 63.5 x 120 | 0.30 | 16.3 |
| 68000 | 689 | 51 x 120 | 0.40 | 13.6 | 63.5 x 120 | 0.35 | 16.6 | 76 x 120 | 0.35 | 18.4 |
| 82000 | 829 | 63.5 x 100 | 0.45 | 14.8 | 76 x 120 | 0.40 | 18.9 | 76 x 140 | 0.40 | 20.0 |
| 100000 | 10T | 63.5 x 120 | 0.45 | 17.6 | 76 x 120 | 0.45 | 19.5 | 76 x 140 | 0.50 | 20.0 |
| 120000 | 12T | 63.5 x 120 | 0.55 | 17.6 | 76 x 120 | 0.55 | 19.5 | 90 x 140 | 0.60 | 21.8 |
| 150000 | 15T | 76 x 120 | 0.65 | 19.8 | 90 x 140 | 0.60 | 23.9 | | | |
| 180000 | 18T | 76 x 120 | 0.80 | 19.8 | 90 x 140 | 0.75 | 23.9 | | | |
| 220000 | 22T | 76 x 140 | 0.80 | 23.4 | | | | | | |
| 270000 | 27T | 90 x 140 | 1.00 | 25.5 | | | | | | |

Maximum Allowable Ripple Current (Arms) at 105°C 120Hz
tan δ at 20°C 120Hz

Case Size ΦD x L (mm)

Specifications are subject to change without notice. Should a safety or technical concern arise regarding the product, please be sure to contact our sales offices or agents immediately.

STANDARD RATINGS

| Voltage (Code) | | 80V (1K) | | | 100V (2A) | | | 160V (2C) | | |
|----------------|------|------------|-------|----------------|------------|-------|----------------|------------|-------|----------------|
| SV | | 100 | | | 125 | | | 200 | | |
| Cap. (μF) | Code | Case Size | tan δ | Ripple Current | Case Size | tan δ | Ripple Current | Case Size | tan δ | Ripple Current |
| 560 | 567 | | | | | | | 35 x 50 | 0.15 | 1.2 |
| 680 | 687 | | | | | | | 35 x 50 | 0.15 | 1.3 |
| 820 | 827 | | | | | | | 35 x 50 | 0.15 | 1.4 |
| 1000 | 108 | | | | | | | 35 x 50 | 0.15 | 1.6 |
| 1200 | 128 | | | | | | | 35 x 60 | 0.15 | 1.9 |
| 1500 | 158 | | | | | | | 35 x 60 | 0.15 | 2.1 |
| 1800 | 188 | | | | 35 x 50 | 0.10 | 2.7 | 35 x 80 | 0.15 | 2.5 |
| 2200 | 228 | 35 x 50 | 0.15 | 2.4 | 35 x 50 | 0.10 | 3.0 | 35 x 80 | 0.15 | 2.8 |
| 2700 | 278 | 35 x 50 | 0.15 | 2.7 | 35 x 60 | 0.10 | 3.5 | 35 x 100 | 0.15 | 3.3 |
| 3300 | 338 | 35 x 50 | 0.15 | 3.0 | 35 x 80 | 0.10 | 4.2 | 35 x 120 | 0.15 | 3.8 |
| 3900 | 398 | 35 x 60 | 0.15 | 3.4 | 35 x 80 | 0.12 | 4.2 | 51 x 80 | 0.20 | 3.8 |
| 4700 | 478 | 35 x 60 | 0.15 | 3.7 | 35 x 100 | 0.12 | 5.0 | 51 x 100 | 0.20 | 4.6 |
| 5600 | 568 | 35 x 80 | 0.15 | 4.5 | 35 x 100 | 0.12 | 5.4 | 51 x 100 | 0.20 | 5.1 |
| 6800 | 688 | 35 x 80 | 0.15 | 4.9 | 35 x 120 | 0.15 | 5.8 | 51 x 120 | 0.20 | 6.1 |
| 8200 | 828 | 35 x 100 | 0.20 | 5.1 | 51 x 80 | 0.15 | 6.4 | 63.5 x 100 | 0.20 | 7.0 |
| 10000 | 109 | 35 x 120 | 0.20 | 6.1 | 51 x 100 | 0.15 | 7.8 | 63.5 x 120 | 0.20 | 8.4 |
| 12000 | 129 | 51 x 80 | 0.20 | 6.7 | 51 x 120 | 0.15 | 9.3 | 76 x 100 | 0.20 | 9.4 |
| 15000 | 159 | 51 x 100 | 0.20 | 8.3 | 51 x 120 | 0.15 | 10.4 | 76 x 120 | 0.20 | 11.4 |
| 18000 | 189 | 51 x 120 | 0.20 | 9.9 | 63.5 x 100 | 0.20 | 10.4 | 76 x 140 | 0.20 | 13.4 |
| 22000 | 229 | 51 x 120 | 0.20 | 11.0 | 63.5 x 120 | 0.20 | 12.5 | 90 x 140 | 0.25 | 14.5 |
| 27000 | 279 | 63.5 x 100 | 0.25 | 11.4 | 76 x 120 | 0.25 | 13.7 | 90 x 140 | 0.25 | 16.0 |
| 33000 | 339 | 76 x 100 | 0.25 | 13.9 | 76 x 120 | 0.25 | 15.2 | | | |
| 39000 | 399 | 76 x 100 | 0.30 | 13.9 | 76 x 140 | 0.30 | 16.1 | | | |
| 47000 | 479 | 76 x 120 | 0.30 | 16.5 | 90 x 140 | 0.30 | 19.3 | | | |
| 56000 | 569 | 76 x 120 | 0.30 | 18.1 | 90 x 140 | 0.30 | 21.1 | | | |
| 68000 | 689 | 76 x 140 | 0.35 | 19.7 | | | | | | |
| 82000 | 829 | 90 x 140 | 0.40 | 22.1 | | | | | | |

Maximum Allowable Ripple Current (Arms) at 105°C 120Hz
tan δ at 20°C 120Hz

Case Size φD x L (mm)

| Voltage (Code) | | 200V (2D) | | | 250V (2E) | | | 315V (2F) | | |
|----------------|------|------------|-------|----------------|------------|-------|----------------|------------|-------|----------------|
| SV | | 250 | | | 300 | | | 365 | | |
| Cap. (μF) | Code | Case Size | tan δ | Ripple Current | Case Size | tan δ | Ripple Current | Case Size | tan δ | Ripple Current |
| 180 | 187 | | | | | | | 35 x 50 | 0.10 | 0.8 |
| 220 | 227 | | | | | | | 35 x 50 | 0.10 | 0.9 |
| 270 | 277 | | | | 35 x 50 | 0.15 | 0.8 | 35 x 50 | 0.10 | 1.0 |
| 330 | 337 | 35 x 50 | 0.15 | 0.9 | 35 x 50 | 0.15 | 0.9 | 35 x 50 | 0.10 | 1.1 |
| 390 | 397 | 35 x 50 | 0.15 | 1.0 | 35 x 50 | 0.15 | 1.0 | 35 x 50 | 0.10 | 1.2 |
| 470 | 477 | 35 x 50 | 0.15 | 1.1 | 35 x 50 | 0.15 | 1.1 | 35 x 60 | 0.10 | 1.4 |
| 560 | 567 | 35 x 50 | 0.15 | 1.2 | 35 x 50 | 0.15 | 1.2 | 35 x 60 | 0.10 | 1.5 |
| 680 | 687 | 35 x 50 | 0.15 | 1.3 | 35 x 60 | 0.15 | 1.4 | 35 x 80 | 0.10 | 1.7 |
| 820 | 827 | 35 x 50 | 0.15 | 1.4 | 35 x 80 | 0.15 | 1.6 | 35 x 80 | 0.15 | 1.7 |
| 1000 | 108 | 35 x 60 | 0.15 | 1.7 | 35 x 80 | 0.20 | 1.6 | 35 x 100 | 0.15 | 2.0 |
| 1200 | 128 | 35 x 60 | 0.15 | 1.9 | 35 x 80 | 0.20 | 1.8 | 35 x 120 | 0.15 | 2.4 |
| 1500 | 158 | 35 x 80 | 0.15 | 2.3 | 35 x 100 | 0.20 | 2.1 | 51 x 80 | 0.15 | 2.7 |
| 1800 | 188 | 35 x 80 | 0.15 | 2.5 | 35 x 120 | 0.20 | 2.5 | 51 x 100 | 0.15 | 3.3 |
| 2200 | 228 | 35 x 100 | 0.15 | 3.0 | 51 x 80 | 0.20 | 2.9 | 51 x 120 | 0.15 | 4.0 |
| 2700 | 278 | 35 x 120 | 0.15 | 3.6 | 51 x 100 | 0.20 | 3.5 | 51 x 120 | 0.15 | 4.4 |
| 3300 | 338 | 51 x 80 | 0.15 | 4.1 | 51 x 120 | 0.20 | 4.2 | 63.5 x 100 | 0.15 | 5.1 |
| 3900 | 398 | 51 x 100 | 0.15 | 4.9 | 51 x 120 | 0.20 | 4.6 | 63.5 x 120 | 0.15 | 6.0 |
| 4700 | 478 | 63.5 x 100 | 0.20 | 5.3 | 63.5 x 120 | 0.20 | 5.7 | 76 x 100 | 0.15 | 6.8 |
| 5600 | 568 | 63.5 x 100 | 0.20 | 5.8 | 63.5 x 120 | 0.20 | 6.3 | 76 x 120 | 0.15 | 8.0 |
| 6800 | 688 | 63.5 x 120 | 0.20 | 6.9 | 76 x 120 | 0.20 | 7.7 | 76 x 130 | 0.15 | 9.2 |
| 8200 | 828 | 63.5 x 120 | 0.20 | 7.6 | 76 x 120 | 0.20 | 8.4 | 90 x 140 | 0.15 | 11.4 |
| 10000 | 109 | 76 x 120 | 0.20 | 9.3 | 76 x 140 | 0.20 | 10.0 | 90 x 140 | 0.15 | 12.6 |
| 12000 | 129 | 76 x 120 | 0.20 | 10.2 | 90 x 140 | 0.20 | 11.9 | | | |
| 15000 | 159 | 76 x 140 | 0.20 | 12.2 | | | | | | |
| 18000 | 189 | 90 x 140 | 0.25 | 13.1 | | | | | | |

Maximum Allowable Ripple Current (Arms) at 105°C 120Hz
tan δ at 20°C 120Hz

Case Size φD x L (mm)

Specifications are subject to change without notice. Should a safety or technical concern arise regarding the product, please be sure to contact our sales offices or agents immediately.

STANDARD RATINGS

| Voltage (Code) | | 350V (2V) | | | 400V (2G) | | | 450V (2W) | | |
|----------------|------|-----------|-------|----------------|------------|-------|----------------|------------|-------|----------------|
| SV | | 400 | | | 450 | | | 500 | | |
| Cap. (μF) | Code | Case Size | tan δ | Ripple Current | Case Size | tan δ | Ripple Current | Case Size | tan δ | Ripple Current |
| 470 | 477 | | | | | | | 51 x 80 | 0.15 | 1.4 |
| 680 | 687 | | | | | | | 51 x 80 | 0.15 | 1.6 |
| 1000 | 108 | | | | 51 x 80 | 0.15 | 2.2 | 51 x 80 | 0.15 | 1.8 |
| 1200 | 128 | 51 x 80 | 0.15 | 2.4 | 51 x 80 | 0.15 | 2.5 | | | |
| 1500 | 158 | 51 x 80 | 0.15 | 2.8 | 51 x 115 | 0.15 | 3.0 | 51 x 115 | 0.15 | 3.5 |
| 1800 | 188 | 51 x 105 | 0.15 | 3.2 | | | | | | |
| 2200 | 228 | 51 x 115 | 0.15 | 3.8 | 63.5 x 95 | 0.15 | 4.0 | 63.5 x 115 | 0.15 | 5.0 |
| 2700 | 278 | 63.5 x 95 | 0.15 | 4.5 | | | | 76 x 100 | 0.15 | 5.8 |
| 3300 | 338 | | | | 63.5 x 115 | 0.15 | 5.0 | 76 x 100 | 0.15 | 6.5 |
| 3900 | 398 | 76 x 90 | 0.15 | 6.0 | | | | | | |
| 4700 | 478 | | | | 76 x 115 | 0.15 | 7.0 | 76 x 130 | 0.15 | 8.0 |
| 5600 | 568 | 76 x 130 | 0.15 | 8.3 | 76 x 140 | 0.15 | 8.5 | 76 x 155 | 0.15 | 9.0 |
| 6800 | 688 | 76 x 140 | 0.15 | 9.5 | 90 x 130 | 0.15 | 10.0 | 90 x 155 | 0.15 | 10.5 |
| 8200 | 828 | 90 x 140 | 0.15 | 11.4 | | | | 90 x 195 | 0.15 | 13.0 |
| 10000 | 109 | | | | | | | 90 x 195 | 0.15 | 14.0 |
| 12000 | 129 | | | | | | | 90 x 230 | 0.15 | 15.7 |
| 15000 | 159 | | | | | | | 90 x 250 | 0.15 | 18.2 |

Maximum Allowable Ripple Current (Arms) at 105°C 120Hz
tan δ at 20°C 120Hz

Case Size ΦD x L (mm)

| Voltage (Code) | | 500V (2H) | | |
|----------------|------|------------|-------|----------------|
| SV | | 550 | | |
| Cap. (μF) | Code | Case Size | tan δ | Ripple Current |
| 330 | 337 | 51 x 80 | 0.15 | 1.1 |
| 470 | 477 | 51 x 80 | 0.15 | 1.3 |
| 680 | 687 | 51 x 105 | 0.15 | 1.8 |
| 1000 | 108 | 51 x 115 | 0.15 | 2.1 |
| 1500 | 158 | 63.5 x 115 | 0.15 | 3.0 |
| 2200 | 228 | 63.5 x 130 | 0.15 | 3.7 |
| 2700 | 278 | 63.5 x 150 | 0.15 | 4.4 |
| | | 76 x 115 | 0.15 | 4.4 |
| 3300 | 338 | 63.5 x 170 | 0.15 | 5.2 |
| | | 76 x 155 | 0.15 | 5.2 |
| 3900 | 398 | 76 x 155 | 0.15 | 5.8 |
| 4700 | 478 | 76 x 190 | 0.15 | 6.9 |
| | | 90 x 155 | 0.15 | 6.9 |
| 5600 | 568 | 90 x 155 | 0.15 | 7.2 |
| 6800 | 688 | 90 x 170 | 0.15 | 8.3 |
| 8200 | 828 | 90 x 220 | 0.15 | 10.2 |
| 10000 | 109 | 90 x 250 | 0.15 | 12.0 |

Maximum Allowable Ripple Current (Arms) at 105°C 120Hz
tan δ at 20°C 120Hz

Case Size ΦD x L (mm)

Specifications are subject to change without notice. Should a safety or technical concern arise regarding the product, please be sure to contact our sales offices or agents immediately.

FEATURES

- High voltage and capacitance, high ripple, high reliability, guarantee 5,000 hours load life at 85°C.
- Suitable for use in changeable current circuits in changeable frequencies air-condition etc.



SPECIFICATIONS

| Item | Performance Characteristics | | | | | | | | | | |
|---------------------------------|---|--------------|--|---------|---|---------|-----|-----|-----|-----|-----|
| Operating Temperature Range | -40 to +85°C | -25 to +85°C | | | | | | | | | |
| Rated Working Voltage Range | 10 to 100V | 160 to 550V | | | | | | | | | |
| Nominal Capacitance Range | 1000 to 1500000µF | | | | | | | | | | |
| Capacitance Tolerance | ±20% at 120Hz, +20°C | | | | | | | | | | |
| Leakage Current | I ≤ 0.02CV (µA) or 5 (mA) whichever is smaller measured after 5 minutes application of rated working voltage at +20°C | | | | | | | | | | |
| tan δ (120Hz, +20°C) | Φ D | L | V | 10 | 16 | 25 | 35 | 50 | 63 | 80 | 100 |
| | 35 | 80~100 | 120 | 0.6 | 0.4 | 0.4 | 0.3 | 0.3 | 0.3 | 0.2 | 0.1 |
| | | | | 0.7 | 0.6 | 0.4 | 0.3 | 0.3 | 0.2 | 0.2 | |
| | 51 | 70~100 | 120~140 | 0.9 | 0.6 | 0.5 | 0.4 | 0.3 | 0.3 | 0.2 | 0.2 |
| | | | | 1 | 0.8 | 0.5 | 0.4 | 0.3 | 0.3 | 0.2 | 0.2 |
| | 63.5 | 100 | 105~220 | 0.9 | — | — | 0.5 | 0.4 | 0.3 | 0.3 | — |
| | | | | 1.2 | 0.8 | 0.7 | — | — | 0.3 | 0.3 | 0.2 |
| | 76 | 100 | 120~140 | 1.6 | — | — | 0.7 | — | — | — | — |
| | | | | 1.6 | 1.1 | 0.8 | 0.8 | 0.6 | 0.5 | 0.4 | 0.3 |
| | 90 | 140~220 | 2 | 1.5 | 1 | 0.9 | 0.8 | 0.6 | 0.4 | 0.3 | |
| | | | | 2 | 1.5 | 1 | 0.9 | 0.8 | 0.6 | 0.4 | 0.3 |
| | 100 | 250 | 2.4 | 1.5 | 1 | 0.9 | 0.8 | 0.6 | 0.4 | 0.3 | |
| 1.5 | | | | 1 | 0.9 | 0.8 | 0.6 | 0.4 | 0.3 | | |
| Low Temperature Characteristics | Φ D | L | V | 160~250 | 350~450 | | | | | | |
| | 35 | 80~120 | 120 | 0.15 | 0.25 | | | | | | |
| | | | | 0.15 | 0.25 | | | | | | |
| | 51 | 70~140 | 120 | 0.15 | 0.25 | | | | | | |
| | | | | 0.20 | 0.25 | | | | | | |
| | 63.5 | 90~190 | 120 | 0.20 | 0.25 | | | | | | |
| | | | | 0.20 | 0.25 | | | | | | |
| | 76 | 90~220 | 120 | 0.20 | 0.25 | | | | | | |
| | | | | 0.20 | 0.25 | | | | | | |
| | 90 | 130~230 | 120 | 0.20 | 0.25 | | | | | | |
| 0.25 | | | | 0.25 | | | | | | | |
| 100 | 250 | 120 | 0.25 | 0.25 | | | | | | | |
| | | | 0.25 | 0.25 | | | | | | | |
| High Temperature Loading | Impedance ratio max. at 120Hz | | Working Voltage (V) | | 10~100 | 160~500 | | | | | |
| | Z-25°C / Z+20°C | | Z-40°C / Z+20°C | | — | 8 | | | | | |
| | Z-40°C / Z+20°C | | Z-40°C / Z+20°C | | 15 | — | | | | | |
| Shelf Life | Test time : 5,000 hours | | Post test requirements at +20°C | | Leakage current : ≤ Initial specified value | | | | | | |
| | Test temperature : +85°C | | Test conditions : Rated DC working voltage with rated ripple current | | Cap. change : within ±20% of the initial measured value | | | | | | |
| Industrial Standard | At +85°C no voltage applied after 1,000 hours and then being stabilized at +20°C the capacitors shall meet the following limits | | tan δ : ≤ 200% of the initial specified value | | Leakage current : ≤ Initial specified value | | | | | | |
| | Cap. change : within ±20% of the initial measured value | | tan δ : ≤ 200% of the initial specified value | | JIS C - 5101-4 (IEC 60384-4) | | | | | | |

RIPPLE CURRENT MULTIPLIER

Frequency Coefficient

| Coefficient | Rated Voltage | 50 | 120 | 300 | 1k | 10k~ |
|-------------|---------------|------|------|------|------|------|
| <160V | 0.80 | 1.00 | 1.08 | 1.15 | 1.15 | |
| ≥160V | 0.80 | 1.00 | 1.08 | 1.15 | 1.20 | |

PART NUMBER SYSTEM (EXAMPLE : 400V 2200µF)

| | | | | | | | |
|---|----|-----|---|----|----|-------|-------|
| 1 | 23 | 456 | 7 | 89 | 10 | 11 12 | 13 14 |
| E | WX | 228 | M | 2G | S | 1M | OO |

Type (Terminal Code)
 Case Length (110mm)
 Diameter (51mm)
 Voltage (400V)
 Tolerance (±20%)
 Capacitance (2200µF)
 Series
 E-CAP

CASE SIZE TABLE



Dimensions of mounting bracket

| Voltage (Code) | | 3 - Leg | | | | 2 - Leg | | | | |
|----------------|----------|---------|------|------|------|---------|------|------|------|-----|
| Symbol | ΦD | 51 | 63.5 | 76 | 90 | 35 | 51 | 63.5 | 76 | 90 |
| P | | 32.5 | 38.1 | 44.5 | 50.8 | 24 | 33.2 | 40.5 | 46.5 | 53 |
| A | | 38.5 | 43 | 49.2 | 58.5 | 29 | 40 | 46.5 | 53 | 59 |
| T | | 7.5 | 8.0 | 7.0 | 8.0 | 6.0 | 6.0 | 7.0 | 6.0 | 6.0 |
| S | | 5.0 | 5.0 | 5.0 | 5.0 | 3.5 | 4.5 | 4.5 | 4.5 | 4.5 |
| U | | 12 | 14 | 14 | 18 | 10 | 14 | 14 | 14 | 14 |
| θ° | | 60 | 60 | 60 | 60 | 30 | 30 | 30 | 30 | 30 |
| H | | 20 | 25 | 30 | 35 | 15 | 25 | 35 | 35 | 35 |
| h | | 15 | 20 | 24 | 25 | 10 | 15 | 20 | 20 | 20 |

STANDARD RATINGS

| Voltage (Code) | | 10V (1A) | | 16V (1C) | | 25V (1E) | | 35V (1V) | |
|----------------|------|------------|----------------|------------|----------------|------------|----------------|------------|----------------|
| SV | | 13 | | 20 | | 32 | | 44 | |
| Cap. (µF) | Code | Case Size | Ripple Current | Case Size | Ripple Current | Case Size | Ripple Current | Case Size | Ripple Current |
| 33000 | 339 | | | | | 35 x 80 | 6.2 | 35 x 80 | 6.2 |
| 47000 | 479 | 35 x 80 | 6.0 | 35 x 80 | 6.4 | 35 x 100 | 8.2 | 35 x 120 | 8.2 |
| 68000 | 689 | 35 x 80 | 7.2 | 35 x 100 | 7.9 | 35 x 120 | 9.4 | 51 x 80 | 9.3 |
| 100000 | 10T | 35 x 100 | 8.8 | 35 x 120 | 10.6 | 51 x 100 | 12.0 | 51 x 120 | 13.6 |
| 150000 | 15T | 51 x 80 | 10.7 | 51 x 100 | 11.5 | 51 x 120 | 15.3 | 63.5 x 100 | 14.5 |
| 220000 | 22T | 51 x 100 | 13.0 | 51 x 120 | 15.6 | 63.5 x 120 | 18.9 | 76 x 100 | 16.8 |
| 330000 | 33T | 63.5 x 100 | 15.9 | 63.5 x 120 | 25.1 | 76 x 120 | 24.8 | 76 x 140 | 24.8 |
| 470000 | 47T | 63.5 x 120 | 19.0 | 76 x 120 | 30.5 | 90 x 170 | 30.8 | 90 x 170 | 32.6 |
| 680000 | 68T | 76 x 120 | 22.8 | 90 x 170 | 33.0 | 90 x 220 | 33.3 | 90 x 220 | 35.2 |
| 1000000 | 10M | 90 x 170 | 27.7 | 90 x 220 | 36.0 | | | | |
| 1500000 | 15M | 90 x 220 | 33.9 | | | | | | |

Maximum Allowable Ripple Current (Arms) at 85°C 120Hz

Case Size Φ D x L (mm)

| Voltage (Code) | | 50V (1H) | | 63V (1J) | | 80V (1K) | | 100V (2A) | |
|----------------|------|------------|----------------|------------|----------------|------------|----------------|------------|----------------|
| SV | | 63 | | 79 | | 100 | | 125 | |
| Cap. (µF) | Code | Case Size | Ripple Current | Case Size | Ripple Current | Case Size | Ripple Current | Case Size | Ripple Current |
| 4700 | 478 | | | | | | | 35 x 80 | 3.8 |
| 6800 | 688 | | | | | | | 35 x 100 | 4.5 |
| 10000 | 109 | | | 35 x 80 | 4.1 | 35 x 100 | 4.6 | 51 x 80 | 5.4 |
| 15000 | 159 | 35 x 80 | 5.4 | 35 x 100 | 5.5 | 35 x 120 | 6.0 | 51 x 100 | 6.6 |
| 22000 | 229 | 35 x 100 | 6.1 | 35 x 120 | 7.1 | 51 x 100 | 7.2 | 63.5 x 100 | 7.7 |
| 33000 | 339 | 51 x 70 | 7.0 | 51 x 100 | 9.7 | 51 x 120 | 9.2 | 76 x 100 | 10.8 |
| 47000 | 479 | 51 x 90 | 8.6 | 51 x 120 | 11.7 | 63.5 x 120 | 13.8 | 76 x 120 | 14.9 |
| 68000 | 689 | 51 x 120 | 11.9 | 63.5 x 120 | 16.2 | 63.5 x 140 | 15.5 | 76 x 150 | 18.8 |
| 100000 | 10T | 63.5 x 100 | 14.2 | 63.5 x 140 | 20.8 | 90 x 140 | 23.4 | 90 x 170 | 22.1 |
| 150000 | 15T | 76 x 120 | 18.6 | 90 x 140 | 28.6 | 90 x 170 | 26.5 | 90 x 220 | 27.0 |
| 220000 | 22T | 90 x 140 | 20.3 | 90 x 170 | 28.3 | 90 x 220 | 28.9 | | |
| 330000 | 33T | 90 x 170 | 25.3 | 90 x 220 | 31.2 | | | | |
| 470000 | 47T | 90 x 220 | 33.2 | | | | | | |

Maximum Allowable Ripple Current (Arms) at 85°C 120Hz

Case Size Φ D x L (mm)

| Voltage (Code) | | 160V (2C) | | 200V (2D) | | 250V (2E) | | 350V (2V) | |
|----------------|------|------------|----------------|------------|----------------|------------|----------------|------------|----------------|
| SV | | 200 | | 250 | | 300 | | 400 | |
| Cap. (µF) | Code | Case Size | Ripple Current | Case Size | Ripple Current | Case Size | Ripple Current | Case Size | Ripple Current |
| 1000 | 108 | | | | | 35 x 80 | 2.4 | | |
| 1500 | 158 | | | 35 x 80 | 2.9 | 35 x 100 | 3.0 | | |
| 2200 | 228 | 35 x 80 | 3.2 | 35 x 100 | 3.5 | 51 x 80 | 4.0 | 51 x 100 | 7.7 |
| 2700 | 278 | | | | | | | 51 x 120 | 9.3 |
| 3300 | 338 | 35 x 120 | 4.7 | 51 x 80 | 4.8 | 51 x 100 | 5.4 | 51 x 130 | 10.8 |
| 3900 | 398 | | | | | | | 63.5 x 120 | 12.1 |
| 4700 | 478 | 51 x 80 | 5.0 | 51 x 100 | 6.3 | 63.5 x 100 | 7.3 | 63.5 x 130 | 14.0 |
| 5600 | 568 | | | | | | | 63.5 x 160 | 16.6 |
| | | | | | | | | 76 x 120 | 16.1 |
| 6800 | 688 | 51 x 100 | 6.4 | 51 x 140 | 7.3 | 63.5 x 120 | 8.9 | 63.5 x 190 | 20.0 |
| | | | | | | | | 76 x 130 | 18.6 |
| 8200 | 828 | | | | | | | 76 x 160 | 22.2 |
| 10000 | 109 | 63.5 x 100 | 9.1 | 63.5 x 120 | 9.8 | 76 x 120 | 11.8 | 76 x 170 | 25.2 |
| 12000 | 129 | | | | | | | 90 x 160 | 29.1 |
| 15000 | 159 | 76 x 100 | 12.0 | 76 x 120 | 13.0 | 90 x 140 | 16.4 | 90 x 190 | 35.7 |
| 22000 | 229 | 76 x 140 | 16.9 | 90 x 140 | 15.9 | 90 x 170 | 17.9 | | |
| 33000 | 339 | 90 x 140 | 19.2 | 90 x 170 | 19.5 | 90 x 220 | 19.7 | | |
| 47000 | 479 | 90 x 170 | 20.6 | 90 x 220 | 20.9 | | | | |
| 68000 | 689 | 90 x 220 | 22.3 | | | | | | |

Maximum Allowable Ripple Current (Arms) at 85°C 120Hz

Case Size Φ D x L (mm)

Specifications are subject to change without notice. Should a safety or technical concern arise regarding the product, please be sure to contact our sales offices or agents immediately.

STANDARD RATINGS

| Voltage (Code) | | 400V (2G) | | 450V (2W) | | 500V (2H) | | 550V (25) | |
|----------------|------|------------|----------------|------------|----------------|------------|----------------|------------|----------------|
| SV | | 450 | | 500 | | 550 | | 600 | |
| Cap. (μF) | Code | Case Size | Ripple Current | Case Size | Ripple Current | Case Size | Ripple Current | Case Size | Ripple Current |
| 1000 | 108 | 51 x 80 | 5.0 | 51 x 80 | 5.0 | 51 x 110 | 4.2 | 51 x 130 | 4.3 |
| 1200 | 128 | 51 x 80 | 5.8 | 51 x 100 | 5.7 | 63.5 x 90 | 4.8 | 63.5 x 110 | 5.0 |
| 1500 | 158 | 51 x 100 | 6.4 | 51 x 100 | 6.3 | 63.5 x 90 | 5.5 | 63.5 x 130 | 6.0 |
| 1800 | 188 | 51 x 100 | 7.0 | 51 x 120 | 7.6 | 63.5 x 110 | 6.5 | 76 x 100 | 6.4 |
| 2200 | 228 | 63.5 x 90 | 8.3 | 51 x 130 | 8.8 | 63.5 x 130 | 7.7 | 76 x 110 | 7.4 |
| | | 51 x 140 | 8.5 | 63.5 x 100 | 8.5 | | | | |
| 2700 | 278 | 51 x 130 | 9.8 | 63.5 x 120 | 10.1 | 76 x 110 | 8.8 | 76 x 120 | 8.5 |
| 3300 | 338 | 63.5 x 120 | 11.1 | 63.5 x 130 | 11.7 | 76 x 130 | 10.4 | 76 x 140 | 10.1 |
| | | | | 76 x 110 | 12.0 | | | | |
| 3900 | 398 | 63.5 x 130 | 12.7 | 63.5 x 160 | 13.8 | 76 x 130 | 11.4 | 76 x 160 | 11.7 |
| | | | | 76 x 120 | 13.4 | | | | |
| 4700 | 478 | 63.5 x 130 | 13.8 | 76 x 130 | 15.5 | 90 x 130 | 13.7 | 90 x 150 | 13.7 |
| | | 63.5 x 160 | 15.2 | 90 x 120 | 15.0 | | | | |
| | | 76 x 120 | 14.7 | | | | | | |
| 5600 | 568 | 63.5 x 190 | 18.2 | 76 x 155 | 18.0 | 90 x 150 | 15.9 | 90 x 170 | 15.8 |
| | | 76 x 130 | 16.9 | 90 x 155 | 18.3 | | | | |
| 6800 | 688 | 76 x 150 | 18.2 | 76 x 170 | 20.7 | 90 x 170 | 18.5 | 90 x 200 | 18.6 |
| | | | | 90 x 150 | 21.0 | | | | |
| | | | | 76 x 155 | 21.8 | | | | |
| 8200 | 828 | 76 x 170 | 22.8 | 90 x 160 | 24.1 | 90 x 190 | 21.4 | | |
| | | 90 x 150 | 23.0 | | | | | | |
| | | | | | | | | | |
| 10000 | 109 | 90 x 160 | 26.6 | 90 x 155 | 26.7 | | | | |
| | | | | 90 x 170 | 27.8 | | | | |
| 12000 | 129 | 90 x 170 | 30.0 | 90 x 230 | 29.5 | | | | |
| 15000 | 159 | 90 x 230 | 32.0 | | | | | | |

Maximum Allowable Ripple Current (Arms) at 85°C 120Hz

Case Size Φ D x L (mm)

Specifications are subject to change without notice. Should a safety or technical concern arise regarding the product, please be sure to contact our sales offices or agents immediately.

FEATURES

- Load life of 5,000 hours application of ripple current at +105°C.
- High reliability products.



SPECIFICATIONS

| Item | Performance Characteristics | |
|---------------------------------|--|---|
| Operating Temperature Range | -40 to +105°C | -25 to +105°C |
| Rated Working Voltage Range | 10 to 100V | 160 to 500V |
| Nominal Capacitance Range | 330 to 390000µF | |
| Capacitance Tolerance | ±20% at 120Hz, +20°C | |
| Leakage Current | I ≤ 0.02CV (µA) or 5 (mA) whichever is smaller measured after 5 minutes application of rated working voltage at +20°C | |
| tan δ (120Hz, +20°C) | The values shown in the STANDARD RATINGS tables | |
| Low Temperature Characteristics | Impedance ratio max. at 120Hz | |
| | Working Voltage (V) | 10~100 160~500 |
| | Z-25°C / Z+20°C | - 8 |
| | Z-40°C / Z+20°C | 15 - |
| High Temperature Loading | Test time : 5,000 hours | Post test requirements at +20°C |
| | Test temperature : +105°C | Leakage current : ≤ Initial specified value |
| | Test conditions : Rated DC working voltage with rated ripple current | Cap. change : within ±20% of the initial measured value |
| | | tan δ : ≤ 200% of the initial specified value |
| Shelf Life | At +105°C no voltage applied after 1,000 hours and then being stabilized at +20°C the capacitors shall meet the following limits | |
| | Leakage current : ≤ Initial specified value | |
| | Cap. change : within ±20% of the initial measured value | |
| | tan δ : ≤ 200% of the initial specified value | |
| Industrial Standard | JIS C - 5101-4 (IEC 60384-4) | |

RIPPLE CURRENT MULTIPLIER

Frequency Coefficient

| Coefficient | Freq. (Hz) | | | | | |
|---------------|------------|------|------|------|------|--|
| Rated Voltage | 50 | 120 | 300 | 1k | 10k~ | |
| <160V | 0.80 | 1.00 | 1.08 | 1.15 | 1.15 | |
| ≥160V | 0.80 | 1.00 | 1.08 | 1.15 | 1.20 | |

PART NUMBER SYSTEM (EXAMPLE : 350V 6800µF)

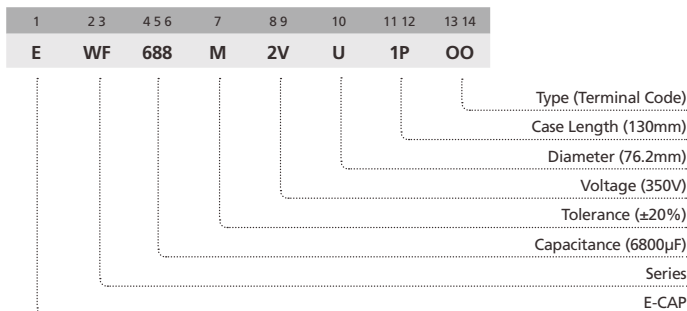

CASE SIZE TABLE

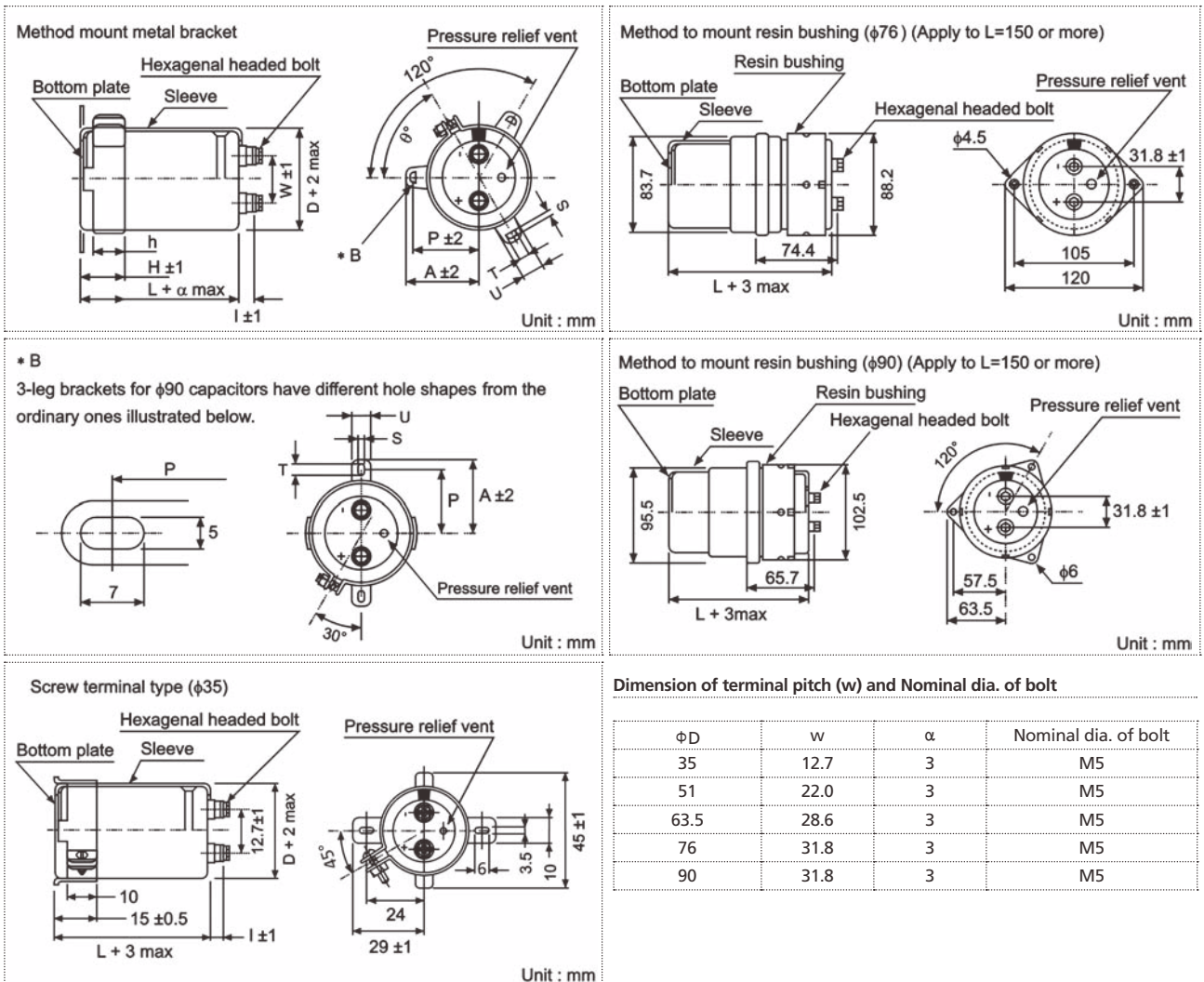

Dimensions of mounting bracket

| Voltage (Code) | | 3 - Leg | | | | 2 - Leg | | | | |
|----------------|----|---------|------|------|------|---------|------|------|------|-----|
| Symbol | φD | 51 | 63.5 | 76 | 90 | 35 | 51 | 63.5 | 76 | 90 |
| P | | 32.5 | 38.1 | 44.5 | 50.8 | 24 | 33.2 | 40.5 | 46.5 | 53 |
| A | | 38.5 | 43 | 49.2 | 58.5 | 29 | 40 | 46.5 | 53 | 59 |
| T | | 7.5 | 8.0 | 7.0 | 8.0 | 6.0 | 6.0 | 7.0 | 6.0 | 6.0 |
| S | | 5.0 | 5.0 | 5.0 | 5.0 | 3.5 | 4.5 | 4.5 | 4.5 | 4.5 |
| U | | 12 | 14 | 14 | 18 | 10 | 14 | 14 | 14 | 14 |
| θ° | | 60 | 60 | 60 | 60 | 30 | 30 | 30 | 30 | 30 |
| H | | 20 | 25 | 30 | 35 | 15 | 25 | 35 | 35 | 35 |
| h | | 15 | 20 | 24 | 25 | 10 | 15 | 20 | 20 | 20 |

STANDARD RATINGS

| Voltage (Code) | | 10V (1A) | | | 16V (1C) | | | 25V (1E) | | |
|----------------|------|------------|-------|----------------|------------|-------|----------------|------------|-------|----------------|
| SV | | 13 | | | 20 | | | 32 | | |
| Cap. (µF) | Code | Case Size | tan δ | Ripple Current | Case Size | tan δ | Ripple Current | Case Size | tan δ | Ripple Current |
| 12000 | 129 | | | | | | | 35 x 80 | 0.35 | 3.3 |
| 15000 | 159 | | | | 35 x 50 | 0.45 | 2.9 | 35 x 80 | 0.35 | 3.7 |
| 18000 | 189 | | | | 35 x 80 | 0.45 | 3.5 | 35 x 80 | 0.35 | 4.0 |
| 22000 | 229 | | | | 35 x 80 | 0.45 | 3.9 | 35 x 80 | 0.35 | 4.5 |
| 27000 | 279 | 35 x 80 | 0.45 | 4.3 | 35 x 80 | 0.45 | 4.3 | 35 x 100 | 0.40 | 5.0 |
| 33000 | 339 | 35 x 80 | 0.45 | 4.7 | 35 x 100 | 0.50 | 4.8 | 35 x 120 | 0.40 | 5.9 |
| 39000 | 399 | 35 x 80 | 0.45 | 5.3 | 35 x 100 | 0.50 | 5.3 | 51 x 80 | 0.40 | 6.5 |
| 47000 | 479 | 35 x 100 | 0.45 | 6.1 | 35 x 120 | 0.50 | 6.2 | 51 x 100 | 0.40 | 7.9 |
| 56000 | 569 | 35 x 100 | 0.50 | 6.2 | 51 x 80 | 0.60 | 6.3 | 51 x 120 | 0.40 | 8.8 |
| 68000 | 689 | 35 x 120 | 0.60 | 6.8 | 51 x 100 | 0.60 | 7.6 | 51 x 120 | 0.50 | 9.1 |
| 82000 | 829 | 51 x 80 | 0.60 | 7.8 | 51 x 120 | 0.70 | 8.3 | 63.5 x 100 | 0.50 | 10.6 |
| 100000 | 10T | 51 x 100 | 0.70 | 8.5 | 51 x 120 | 0.70 | 9.2 | 63.5 x 120 | 0.60 | 11.4 |
| 120000 | 12T | 51 x 100 | 0.70 | 9.5 | 63.5 x 100 | 0.80 | 9.9 | 76 x 100 | 0.60 | 12.8 |
| 150000 | 15T | 63.5 x 100 | 0.80 | 11.0 | 76 x 100 | 0.80 | 12.3 | 76 x 120 | 0.75 | 13.7 |
| 180000 | 18T | 63.5 x 100 | 0.80 | 12.1 | 76 x 120 | 0.80 | 14.5 | 76 x 140 | 0.76 | 16.1 |
| 220000 | 22T | 76 x 100 | 1.00 | 13.2 | 76 x 140 | 1.00 | 15.2 | 90 x 140 | 1.00 | 16.6 |
| 270000 | 27T | 76 x 120 | 1.20 | 14.4 | 90 x 140 | 1.20 | 16.8 | | | |
| 330000 | 33T | 76 x 140 | 1.20 | 17.0 | | | | | | |
| 390000 | 39T | 90 x 140 | 1.40 | 18.6 | | | | | | |

Maximum Allowable Ripple Current (Arms) at 105°C 120Hz
tan δ at 20°C 120Hz

Case Size ΦD x L (mm)

| Voltage (Code) | | 35V (1V) | | | 50V (1H) | | | 63V (1J) | | |
|----------------|------|------------|-------|----------------|------------|-------|----------------|------------|-------|----------------|
| SV | | 44 | | | 63 | | | 79 | | |
| Cap. (µF) | Code | Case Size | tan δ | Ripple Current | Case Size | tan δ | Ripple Current | Case Size | tan δ | Ripple Current |
| 2700 | 278 | | | | | | | 35 x 50 | 0.19 | 1.9 |
| 3300 | 338 | | | | | | | 35 x 50 | 0.15 | 2.1 |
| 3900 | 398 | | | | 35 x 50 | 0.20 | 2.0 | 35 x 80 | 0.20 | 2.7 |
| 4700 | 478 | | | | 35 x 50 | 0.25 | 2.2 | 35 x 80 | 0.20 | 2.9 |
| 5600 | 568 | | | | 35 x 80 | 0.25 | 2.8 | 35 x 80 | 0.20 | 3.2 |
| 6800 | 688 | | | | 35 x 80 | 0.25 | 3.0 | 35 x 80 | 0.20 | 3.5 |
| 8200 | 828 | 35 x 80 | 0.30 | 3.0 | 35 x 80 | 0.25 | 3.3 | 35 x 100 | 0.25 | 4.2 |
| 10000 | 109 | 35 x 80 | 0.30 | 3.3 | 35 x 80 | 0.25 | 3.7 | 35 x 120 | 0.25 | 4.3 |
| 12000 | 129 | 35 x 80 | 0.30 | 3.6 | 35 x 100 | 0.25 | 4.4 | 51 x 80 | 0.25 | 4.8 |
| 15000 | 159 | 35 x 80 | 0.30 | 4.1 | 35 x 120 | 0.30 | 4.7 | 51 x 100 | 0.25 | 5.9 |
| 18000 | 189 | 35 x 100 | 0.30 | 4.8 | 51 x 80 | 0.35 | 4.8 | 51 x 120 | 0.30 | 6.3 |
| 22000 | 229 | 35 x 120 | 0.35 | 5.2 | 51 x 100 | 0.35 | 5.9 | 51 x 120 | 0.30 | 6.7 |
| 27000 | 279 | 51 x 80 | 0.40 | 5.9 | 51 x 120 | 0.35 | 7.0 | 63.5 x 120 | 0.30 | 8.8 |
| 33000 | 339 | 51 x 100 | 0.40 | 6.6 | 63.5 x 100 | 0.40 | 7.6 | 76 x 120 | 0.35 | 10.0 |
| 39000 | 399 | 51 x 120 | 0.40 | 7.8 | 63.5 x 120 | 0.40 | 8.9 | 76 x 140 | 0.35 | 12.5 |
| 47000 | 479 | 51 x 120 | 0.45 | 8.0 | 63.5 x 120 | 0.40 | 9.8 | 90 x 140 | 0.40 | 13.8 |
| 56000 | 569 | 63.5 x 100 | 0.45 | 9.2 | 76 x 120 | 0.40 | 11.9 | | | |
| 68000 | 689 | 63.5 x 120 | 0.45 | 11.0 | 76 x 140 | 0.45 | 13.1 | | | |
| 82000 | 829 | 76 x 120 | 0.50 | 12.7 | 90 x 140 | 0.50 | 14.8 | | | |
| 100000 | 10T | 76 x 140 | 0.60 | 13.5 | | | | | | |
| 120000 | 12T | 90 x 140 | 0.60 | 16.1 | | | | | | |

Maximum Allowable Ripple Current (Arms) at 105°C 120Hz
tan δ at 20°C 120Hz

Case Size ΦD x L (mm)

Specifications are subject to change without notice. Should a safety or technical concern arise regarding the product, please be sure to contact our sales offices or agents immediately.

STANDARD RATINGS

| Voltage (Code) | | 80V (1K) | | | 100V (2A) | | | 160V (2C) | | |
|----------------|------|------------|-------|----------------|------------|-------|----------------|------------|-------|----------------|
| SV | | 100 | | | 125 | | | 200 | | |
| Cap. (μF) | Code | Case Size | tan δ | Ripple Current | Case Size | tan δ | Ripple Current | Case Size | tan δ | Ripple Current |
| 680 | 687 | | | | | | | 35 x 50 | 0.15 | 1.1 |
| 820 | 827 | | | | | | | 35 x 80 | 0.15 | 1.2 |
| 1000 | 108 | | | | | | | 35 x 80 | 0.15 | 1.3 |
| 1200 | 128 | | | | 35 x 50 | 0.15 | 1.4 | 35 x 80 | 0.15 | 1.5 |
| 1500 | 158 | | | | 35 x 80 | 0.15 | 1.6 | 35 x 80 | 0.15 | 1.7 |
| 1800 | 188 | | | | 35 x 80 | 0.15 | 1.8 | 35 x 100 | 0.15 | 2.0 |
| 2200 | 228 | 35 x 50 | 0.15 | 1.9 | 35 x 80 | 0.15 | 2.0 | 35 x 120 | 0.15 | 2.3 |
| 2700 | 278 | 35 x 80 | 0.15 | 2.2 | 35 x 80 | 0.15 | 2.4 | 35 x 120 | 0.15 | 2.7 |
| 3300 | 338 | 35 x 80 | 0.15 | 2.5 | 35 x 100 | 0.15 | 2.8 | 51 x 100 | 0.15 | 3.3 |
| 3900 | 398 | 35 x 80 | 0.15 | 2.9 | 35 x 120 | 0.15 | 3.1 | 51 x 120 | 0.15 | 3.8 |
| 4700 | 478 | 35 x 100 | 0.15 | 3.1 | 51 x 80 | 0.15 | 3.6 | 51 x 120 | 0.15 | 4.2 |
| 5600 | 568 | 35 x 100 | 0.15 | 3.6 | 51 x 100 | 0.15 | 4.3 | 51 x 120 | 0.15 | 4.7 |
| 6800 | 688 | 35 x 120 | 0.20 | 4.1 | 51 x 120 | 0.15 | 5.0 | 63.5 x 120 | 0.15 | 5.7 |
| 8200 | 828 | 51 x 80 | 0.20 | 4.8 | 51 x 120 | 0.15 | 5.5 | 76 x 100 | 0.20 | 6.4 |
| 10000 | 109 | 51 x 100 | 0.20 | 5.6 | 63.5 x 100 | 0.15 | 6.4 | 76 x 120 | 0.20 | 6.6 |
| 12000 | 129 | 51 x 100 | 0.20 | 6.1 | 63.5 x 120 | 0.20 | 6.6 | 76 x 140 | 0.20 | 7.8 |
| 15000 | 159 | 51 x 120 | 0.20 | 7.4 | 76 x 100 | 0.20 | 7.5 | 90 x 140 | 0.20 | 9.5 |
| 18000 | 189 | 63.5 x 120 | 0.25 | 8.0 | 76 x 120 | 0.25 | 8.0 | | | |
| 22000 | 229 | 76 x 100 | 0.25 | 9.1 | 76 x 140 | 0.25 | 9.4 | | | |
| 27000 | 279 | 76 x 120 | 0.30 | 9.7 | 90 x 140 | 0.30 | 10.4 | | | |
| 33000 | 339 | 76 x 140 | 0.30 | 11.5 | | | | | | |
| 39000 | 399 | 90 x 140 | 0.30 | 12.5 | | | | | | |

Maximum Allowable Ripple Current (Arms) at 105°C 120Hz
tan δ at 20°C 120Hz

Case Size ΦD x L (mm)

| Voltage (Code) | | 200V (2G) | | | 250V (2W) | | | 350V (2H) | | |
|----------------|------|------------|-------|----------------|------------|-------|----------------|------------|-------|----------------|
| SV | | 250 | | | 300 | | | 400 | | |
| Cap. (μF) | Code | Case Size | tan δ | Ripple Current | Case Size | tan δ | Ripple Current | Case Size | tan δ | Ripple Current |
| 330 | 337 | | | | 35 x 50 | 0.15 | 0.7 | | | |
| 390 | 397 | | | | 35 x 80 | 0.15 | 0.8 | | | |
| 470 | 477 | 35 x 50 | 0.15 | 0.9 | 35 x 80 | 0.15 | 0.9 | | | |
| 560 | 567 | 35 x 80 | 0.15 | 1.0 | 35 x 80 | 0.15 | 1.0 | | | |
| 680 | 687 | 35 x 80 | 0.15 | 1.1 | 35 x 100 | 0.15 | 1.2 | | | |
| 820 | 827 | 35 x 80 | 0.15 | 1.3 | 35 x 100 | 0.15 | 1.4 | 51 x 80 | 0.25 | 3.3 |
| 1000 | 108 | 35 x 80 | 0.15 | 1.5 | 35 x 120 | 0.15 | 1.6 | | | |
| 1200 | 128 | 35 x 100 | 0.15 | 1.7 | 51 x 80 | 0.15 | 1.8 | | | |
| 1500 | 158 | 35 x 120 | 0.15 | 1.9 | 51 x 90 | 0.15 | 2.1 | 51 x 90 | 0.25 | 5.2 |
| 1800 | 188 | 35 x 120 | 0.15 | 2.2 | 51 x 100 | 0.15 | 2.4 | | | |
| 2200 | 228 | 51 x 80 | 0.15 | 2.7 | 51 x 110 | 0.15 | 2.7 | 51 x 110 | 0.25 | 7.0 |
| 2700 | 278 | 51 x 100 | 0.15 | 3.2 | 63.5 x 90 | 0.15 | 3.2 | 51 x 130 | 0.25 | 8.4 |
| 3300 | 338 | 51 x 120 | 0.15 | 3.5 | 63.5 x 120 | 0.15 | 4.0 | 63.5 x 90 | 0.25 | 8.1 |
| 3900 | 398 | 63.5 x 100 | 0.15 | 4.0 | 76 x 90 | 0.15 | 4.2 | 51 x 150 | 0.25 | 9.9 |
| 4700 | 478 | 63.5 x 120 | 0.15 | 4.7 | 76 x 120 | 0.15 | 5.2 | 63.5 x 130 | 0.25 | 11.5 |
| 5600 | 568 | 76 x 100 | 0.15 | 5.3 | 76 x 140 | 0.15 | 6.1 | 76 x 90 | 0.25 | 10.8 |
| 6800 | 688 | 76 x 120 | 0.15 | 6.3 | 76 x 140 | 0.15 | 6.7 | 63.5 x 150 | 0.25 | 14.7 |
| 8200 | 828 | 76 x 140 | 0.20 | 6.4 | | | | 76 x 140 | 0.25 | 17.4 |
| 10000 | 109 | 90 x 140 | 0.20 | 7.7 | | | | 76 x 150 | 0.25 | 19.6 |
| 15000 | 159 | | | | | | | 76 x 190 | 0.25 | 23.0 |
| 22000 | 229 | | | | | | | 90 x 190 | 0.25 | 30.6 |
| | | | | | | | | 90 x 260 | 0.25 | 42.7 |

Maximum Allowable Ripple Current (Arms) at 105°C 120Hz
tan δ at 20°C 120Hz

Case Size ΦD x L (mm)

Specifications are subject to change without notice. Should a safety or technical concern arise regarding the product, please be sure to contact our sales offices or agents immediately.

STANDARD RATINGS

| Voltage (Code) | | 400 (2G) | | | 450V (2W) | | | 500V (2H) | | |
|----------------|------|------------|-------|----------------|------------|-------|----------------|------------|-------|----------------|
| SV | | 450 | | | 500 | | | 550 | | |
| Cap. (μF) | Code | Case Size | tan δ | Ripple Current | Case Size | tan δ | Ripple Current | Case Size | tan δ | Ripple Current |
| 470 | 477 | | | | | | | 51 x 80 | 0.25 | 2.4 |
| 560 | 567 | | | | 51 x 80 | 0.25 | 2.6 | | | |
| 680 | 687 | 51 x 80 | 0.25 | 3.0 | | | | | | |
| 820 | 827 | | | | | | | 51 x 90 | 0.25 | 3.6 |
| 1000 | 108 | | | | 51 x 90 | 0.25 | 4.0 | 51 x 110 | 0.25 | 4.4 |
| 1200 | 128 | 51 x 90 | 0.25 | 4.7 | 51 x 110 | 0.25 | 4.8 | 51 x 130 | 0.25 | 5.2 |
| 1500 | 158 | | | | | | | 63.5 x 90 | 0.25 | 5.0 |
| 1800 | 188 | 51 x 110 | 0.25 | 6.3 | 51 x 130 | 0.25 | 6.4 | 51 x 150 | 0.25 | 6.3 |
| | | | | | 63.5 x 90 | 0.25 | 6.2 | 63.5 x 110 | 0.25 | 6.8 |
| 2200 | 228 | 51 x 130 | 0.25 | 7.5 | 51 x 150 | 0.25 | 7.6 | | | |
| | | 63.5 x 90 | 0.25 | 7.3 | 63.5 x 110 | 0.25 | 7.5 | | | |
| 2700 | 278 | 51 x 150 | 0.25 | 8.9 | 63.5 x 130 | 0.25 | 8.9 | 63.5 x 150 | 0.25 | 9.6 |
| | | 63.5 x 110 | 0.25 | 8.8 | 76 x 110 | 0.25 | 9.1 | 76 x 110 | 0.25 | 9.2 |
| 3300 | 338 | 63.5 x 130 | 0.25 | 10.5 | 63.5 x 150 | 0.25 | 10.6 | | | |
| | | 76 x 90 | 0.25 | 9.9 | 76 x 110 | 0.25 | 10.6 | | | |
| 3900 | 398 | | | | 76 x 130 | 0.25 | 11.9 | 76 x 150 | 0.25 | 12.7 |
| | | | | | | | | 90 x 130 | 0.25 | 11.9 |
| 4700 | 478 | 63.5 x 150 | 0.25 | 13.4 | 76 x 140 | 0.25 | 13.6 | | | |
| | | 76 x 130 | 0.25 | 13.9 | | | | | | |
| 5600 | 568 | | | | 76 x 150 | 0.25 | 13.8 | | | |
| 6800 | 688 | 76 x 150 | 0.25 | 17.9 | 76 x 190 | 0.25 | 17.3 | 90 x 190 | 0.25 | 18.8 |
| | | 90 x 130 | 0.25 | 17.2 | 90 x 150 | 0.25 | 16.7 | | | |
| 8200 | 828 | 76 x 190 | 0.25 | 20.8 | | | | | | |
| | | 90 x 150 | 0.25 | 20.1 | | | | | | |
| 10000 | 109 | | | | 90 x 200 | 0.25 | 23.3 | 90 x 260 | 0.25 | 26.3 |
| 12000 | 129 | 90 x 190 | 0.25 | 27.4 | | | | | | |
| 15000 | 159 | | | | 90 x 250 | 0.25 | 31.7 | | | |

Maximum Allowable Ripple Current (Arms) at 105°C 120Hz
tan δ at 20°C 120Hz

Case Size ΦD x L (mm)

FEATURES

- Load life of 10,000 hours application of ripple current at 85°C.
- High ripple, high reliability.
- Best for use in industrial power supplies for inverter circuitry.



SPECIFICATIONS

| Item | Performance Characteristics | |
|---------------------------------|---|--|
| Operating Temperature Range | -25 to +85°C | |
| Rated Working Voltage Range | 350 to 500V | |
| Nominal Capacitance Range | 470 to 22000µF | |
| Capacitance Tolerance | ±20% at 120Hz, +20°C | |
| Leakage Current | I ≤ 0.02CV (µA) or 5 (mA) whichever is smaller measured after 5 minutes application of rated working voltage at +20°C | |
| tan δ (120Hz, +20°C) | Working Voltage (V) | 350~500 |
| | tan δ (max.) | 0.2 |
| Low Temperature Characteristics | Impedance ratio max. at 120Hz | |
| | Working Voltage (V) Z-25°C / Z+20°C | 350~500 8 |
| High Temperature Loading | Test time : 10,000 hours Test temperature : +85°C Test conditions : Rated DC working voltage with rated ripple current | Post test requirements at +20°C Leakage current : ≤ Initial specified value Cap. change : within ±20% of the initial measured tan δ : value ≤ 300% of the initial specified value |
| | Shelf Life | At +85°C no voltage applied after 1,000 hours and then being stabilized at +20°C the capacitors shall meet the following limits Leakage current : ≤ Initial specified value Cap. change : within ±20% of the initial measured value tan δ : ≤ 300% of the initial specified value |
| Industrial Standard | JIS C - 5101-4 (IEC 60384-4) | |

RIPPLE CURRENT MULTIPLIER

Frequency Coefficient

| Coefficient Rated Voltage | Freq. (Hz) | Frequency Coefficient | | | | |
|------------------------------|------------|-----------------------|------|------|------|------|
| | | 50 | 120 | 300 | 1k | 10k~ |
| <160V | | 0.80 | 1.00 | 1.08 | 1.15 | 1.15 |
| ≥160V | | 0.80 | 1.00 | 1.08 | 1.15 | 1.20 |

PART NUMBER SYSTEM (EXAMPLE : 400V 3300µF)

| 1 | 2 3 | 4 5 6 | 7 | 8 9 | 10 | 11 12 | 13 14 |
|---|-----|-------|---|-----|----|-------|-------|
| E | WH | 338 | M | 2G | U | 90 | OO |

Type (Terminal Code)
 Case Length (90mm)
 Diameter (76.2mm)
 Voltage (400V)
 Tolerance (±20%)
 Capacitance (3300µF)
 Series
 E-CAP

CASE SIZE TABLE

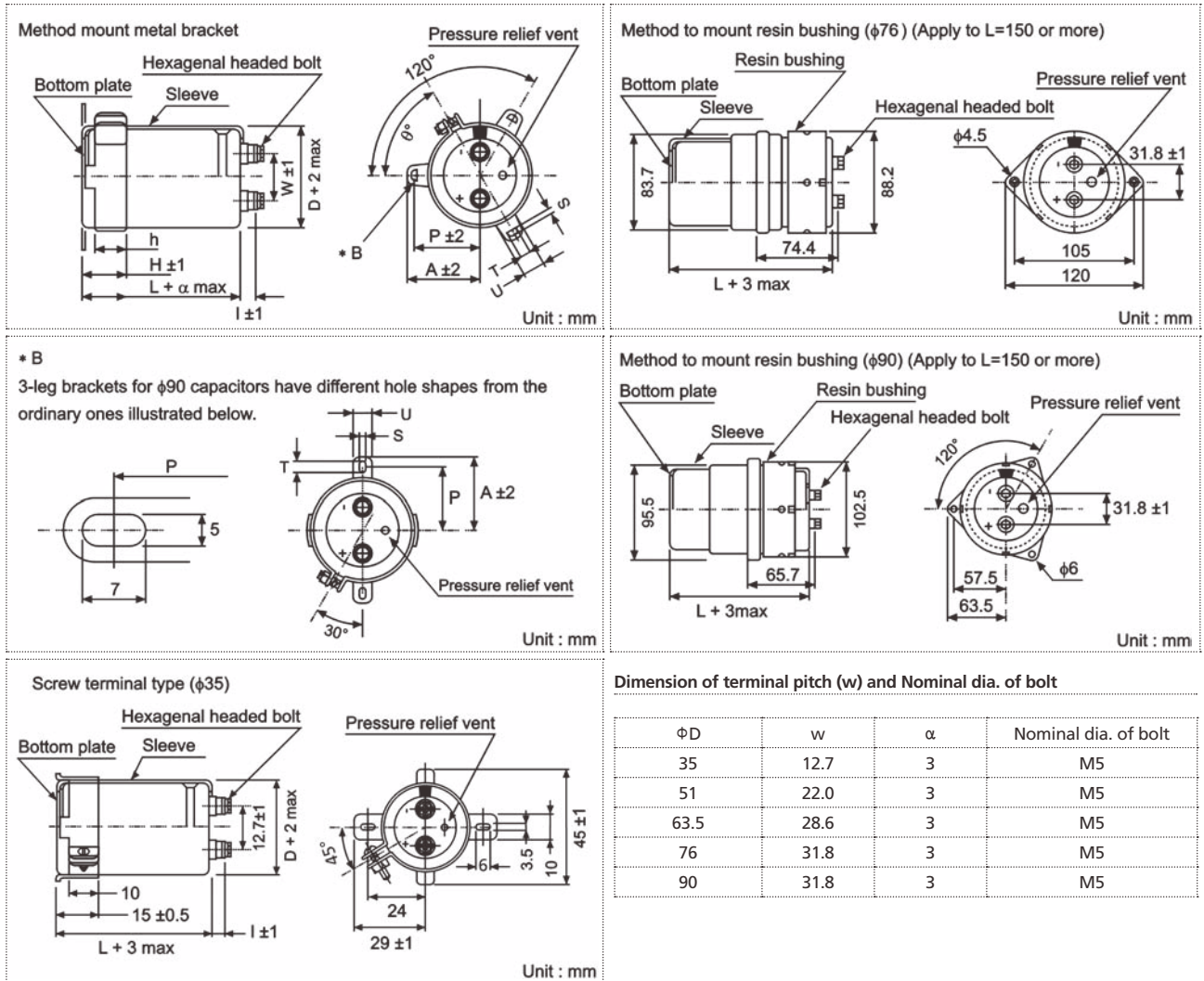

Dimensions of mounting bracket

| Voltage (Code) | | 3 - Leg | | | | 2 - Leg | | | |
|----------------|----------|---------|------|------|------|---------|------|------|-----|
| Symbol | ϕD | 51 | 63.5 | 76 | 90 | 51 | 63.5 | 76 | 90 |
| P | | 32.5 | 38.1 | 44.5 | 50.8 | 33.2 | 40.5 | 46.5 | 53 |
| A | | 38.5 | 43 | 49.2 | 58.5 | 40 | 46.5 | 53 | 59 |
| T | | 7.5 | 8.0 | 7.0 | 8.0 | 6.0 | 7.0 | 6.0 | 6.0 |
| S | | 5.0 | 5.0 | 5.0 | 5.0 | 4.5 | 4.5 | 4.5 | 4.5 |
| U | | 12 | 14 | 14 | 18 | 14 | 14 | 14 | 14 |
| θ° | | 60 | 60 | 60 | 60 | 30 | 30 | 30 | 30 |
| H | | 20 | 25 | 30 | 35 | 25 | 35 | 35 | 35 |
| h | | 15 | 20 | 24 | 25 | 15 | 20 | 20 | 20 |

STANDARD RATINGS

| Voltage (Code) | | 350V (2V) | | 400V (2G) | | 450V (2W) | | 500V (2H) | |
|----------------|------|------------|----------------|------------|----------------|------------|----------------|------------|----------------|
| SV | | 400 | | 450 | | 500 | | 550 | |
| Cap. (µF) | Code | Case Size | Ripple Current | Case Size | Ripple Current | Case Size | Ripple Current | Case Size | Ripple Current |
| 470 | 477 | | | | | | | 51 x 80 | 2.4 |
| 560 | 567 | | | | | 51 x 80 | 2.6 | | |
| 680 | 687 | | | 51 x 80 | 3.0 | | | | |
| 820 | 827 | 51 x 80 | 3.3 | | | | | 51 x 90 | 3.6 |
| 1000 | 108 | | | | | 51 x 90 | 4.0 | 51 x 110 | 4.4 |
| 1200 | 128 | | | 51 x 90 | 4.7 | 51 x 110 | 4.8 | 51 x 130 | 5.2 |
| 1500 | 158 | 51 x 90 | 5.2 | | | | | 63.5 x 90 | 5.0 |
| 1800 | 188 | | | 51 x 110 | 6.3 | 51 x 130 | 6.4 | 63.5 x 110 | 6.8 |
| | | | | | | 63.5 x 90 | 6.2 | | |
| 2200 | 228 | 51 x 110 | 7.0 | 51 x 130 | 7.5 | 51 x 150 | 7.6 | | |
| | | | | 63.5 x 90 | 7.3 | 63.5 x 110 | 7.5 | | |
| 2700 | 278 | 51 x 130 | 8.4 | 51 x 150 | 8.9 | 63.5 x 130 | 8.9 | 63.5 x 150 | 9.6 |
| | | 63.5 x 90 | 8.1 | 63.5 x 110 | 8.8 | 76 x 90 | 8.4 | 76 x 110 | 9.2 |
| 3300 | 338 | 51 x 150 | 9.9 | 63.5 x 130 | 10.5 | 63.5 x 150 | 10.6 | | |
| | | | | 76 x 90 | 9.9 | 76 x 110 | 10.2 | | |
| 3900 | 398 | 63.5 x 130 | 11.5 | | | | | 76 x 150 | 12.7 |
| | | 76 x 90 | 10.8 | | | 76 x 130 | 11.9 | 90 x 130 | 11.9 |
| 4700 | 478 | | | 63.5 x 150 | 13.4 | 76 x 115 | 12.4 | | |
| | | | | 76 x 130 | 13.9 | 76 x 150 | 14.0 | | |
| 5600 | 568 | 63.5 x 150 | 14.7 | | | 90 x 130 | 14.2 | | |
| 6800 | 688 | 76 x 130 | 16.8 | 76 x 150 | 17.9 | 76 x 190 | 17.3 | 90 x 190 | 18.8 |
| | | | | 90 x 130 | 17.2 | 90 x 150 | 16.7 | | |
| 8200 | 828 | 76 x 150 | 19.6 | 76 x 190 | 20.8 | | | | |
| | | | | 90 x 150 | 20.1 | | | | |
| 10000 | 109 | 76 x 190 | 23.0 | | | 90 x 190 | 22.8 | 90 x 270 | 26.8 |
| 12000 | 129 | | | 90 x 190 | 27.4 | | | | |
| 15000 | 159 | 90 x 190 | 30.6 | | | 90 x 270 | 32.8 | | |
| 22000 | 229 | 90 x 270 | 43.5 | 90 x 270 | 39.4 | | | | |

Maximum Allowable Ripple Current (Arms) at 85°C 120Hz

Case Size Φ D x L (mm)

Specifications are subject to change without notice. Should a safety or technical concern arise regarding the product, please be sure to contact our sales offices or agents immediately.

FEATURES

- Load life of 20,000 hours application of ripple current at 85°C.
- High ripple, high reliability.
- Best for use in industrial power supplies for inverter circuitry.



SPECIFICATIONS

| Item | Performance Characteristics | |
|---------------------------------|---|--|
| Operating Temperature Range | -25 to +85°C | |
| Rated Working Voltage Range | 350 to 450V | |
| Nominal Capacitance Range | 2200 to 12000µF | |
| Capacitance Tolerance | ±20% at 120Hz, +20°C | |
| Leakage Current | I ≤ 0.02CV (µA) or 5 (mA) whichever is smaller measured after 5 minutes application of rated working voltage at +20°C | |
| tan δ (120Hz, +20°C) | Working Voltage (V) | 350~450 |
| | tan δ (max.) | 0.25 |
| Low Temperature Characteristics | Impedance ratio max. at 120Hz | |
| | Working Voltage (V) Z-25°C / Z+20°C | 350~450 8 |
| High Temperature Loading | Test time : 20,000 hours Test temperature : +85°C Test conditions : Rated DC working voltage with rated ripple current | Post test requirements at +20°C Leakage current : ≤ Initial specified value Cap. change : within ±30% of the initial measured value tan δ : ≤ 300% of the initial specified value |
| | Shelf Life | At +85°C no voltage applied after 1,000 hours and then being stabilized at +20°C the capacitors shall meet the following limits Leakage current : ≤ Initial specified value Cap. change : within ±20% of the initial measured value tan δ : ≤ 200% of the initial specified value |
| Industrial Standard | JIS C - 5101-4 (IEC 60384-4) | |

RIPPLE CURRENT MULTIPLIER

Frequency Coefficient

| Coefficient Rated Voltage | Freq. (Hz) | | | | | |
|------------------------------|------------|------|------|------|------|--|
| | 50 | 120 | 300 | 1k | 10k~ | |
| < 160V | 0.80 | 1.00 | 1.08 | 1.15 | 1.15 | |
| ≥ 160V | 0.80 | 1.00 | 1.08 | 1.15 | 1.20 | |

PART NUMBER SYSTEM (EXAMPLE : 350V 4700µF)

| 1 | 2 3 | 4 5 6 | 7 | 8 9 | 10 | 11 12 | 13 14 |
|---|-----|-------|---|-----|----|-------|-------|
| E | WL | 478 | M | 2V | U | 1N | OO |

Type (Terminal Code)
 Case Length (120mm)
 Diameter (76.2mm)
 Voltage (350V)
 Tolerance (±20%)
 Capacitance (4700µF)
 Series
 E-CAP

CASE SIZE TABLE



Dimensions of mounting bracket

| Voltage (Code) | | 3 - Leg | | | 2 - Leg | | |
|----------------|----------|---------|------|------|---------|------|-----|
| Symbol | ϕD | 63.5 | 76 | 90 | 63.5 | 76 | 90 |
| P | | 38.1 | 44.5 | 50.8 | 40.5 | 46.5 | 53 |
| A | | 43 | 49.2 | 58.5 | 46.5 | 53 | 59 |
| T | | 8.0 | 7.0 | 8.0 | 7.0 | 6.0 | 6.0 |
| S | | 5.0 | 5.0 | 5.0 | 4.5 | 4.5 | 4.5 |
| U | | 14 | 14 | 18 | 14 | 14 | 14 |
| θ° | | 60 | 60 | 60 | 30 | 30 | 30 |
| H | | 25 | 30 | 35 | 35 | 35 | 35 |
| h | | 20 | 24 | 25 | 20 | 20 | 20 |

STANDARD RATINGS

| Voltage (Code) | | 350V (2V) | | 400V (2G) | | 450V (2W) | |
|----------------|------|------------|----------------|------------|----------------|------------|----------------|
| SV | | 400 | | 450 | | 500 | |
| Cap. (μF) | Code | Case Size | Ripple Current | Case Size | Ripple Current | Case Size | Ripple Current |
| 2200 | 228 | | | | | 63.5 x 120 | 9.1 |
| 2700 | 278 | | | 63.5 x 120 | 10.1 | 63.5 x 130 | 10.6 |
| | | | | | | 76 x 120 | 11.2 |
| 3300 | 338 | 63.5 x 120 | 11.1 | 63.5 x 130 | 11.7 | 63.5 x 160 | 12.7 |
| | | | | | | 76 x 130 | 13.0 |
| 3900 | 398 | 63.5 x 130 | 12.8 | 63.5 x 160 | 13.8 | 63.5 x 170 | 14.4 |
| | | | | 76 x 120 | 14.7 | | |
| 4700 | 478 | 63.5 x 160 | 15.2 | 63.5 x 170 | 15.8 | 76 x 160 | 16.7 |
| | | 76 x 120 | 14.7 | 76 x 130 | 15.5 | | |
| 5600 | 568 | 63.5 x 170 | 17.3 | 63.5 x 190 | 18.2 | 76 x 190 | 20.1 |
| | | 76 x 130 | 16.9 | 76 x 160 | 18.3 | 90 x 160 | 19.9 |
| 6800 | 688 | 63.5 x 190 | 20.0 | 76 x 170 | 21.0 | 90 x 170 | 23.0 |
| | | 76 x 160 | 20.2 | | | | |
| 8200 | 828 | 76 x 170 | 23.1 | 90 x 160 | 24.1 | 90 x 190 | 26.4 |
| 10000 | 109 | 90 x 160 | 26.6 | 90 x 190 | 29.1 | 90 x 190 | 29.1 |
| 12000 | 129 | 90 x 190 | 32.0 | | | | |

Maximum Allowable Ripple Current (Arms) at 85°C 120Hz

Case Size Φ D x L (mm)

FEATURES

- +125°C, high temperature.
- High reliability equipment in automotive power electronics, e.g. integrated starter alternator.



SPECIFICATIONS

| Item | Performance Characteristics | | | |
|---------------------------------|---|---|---------|-----------------|
| Operating Temperature Range | -25 to +125°C | | | |
| Rated Working Voltage Range | 160 to 400V | | | |
| Nominal Capacitance Range | 330 to 15000μF | | | |
| Capacitance Tolerance | ±20% at 120Hz, +20°C | | | |
| Leakage Current | I ≤ 0.02CV (μA) or 5 (mA) whichever is smaller measured after 5 minutes application of rated working voltage at +20°C | | | |
| tan δ (120Hz, +20°C) | The values shown in the STANDARD RATINGS tables | | | |
| Low Temperature Characteristics | Impedance ratio max. at 120Hz | | | |
| | <table border="1"> <tr> <td>Working Voltage (V)</td> <td>160~400</td> </tr> <tr> <td>Z-25°C / Z+20°C</td> <td>8</td> </tr> </table> | Working Voltage (V) | 160~400 | Z-25°C / Z+20°C |
| Working Voltage (V) | 160~400 | | | |
| Z-25°C / Z+20°C | 8 | | | |
| High Temperature Loading | Test time : 3,000 hours | Post test requirements at +20°C | | |
| | Test temperature : +125°C | Leakage current : ≤ Initial specified value | | |
| | Test conditions : Rated DC working voltage with rated ripple current | Cap. change : within ±30% of the initial measured value | | |
| | | tan δ : ≤ 300% of the initial specified value | | |
| Shelf Life | At +125°C no voltage applied after 1,000 hours and then being stabilized at +20°C the capacitors shall meet the following limits | | | |
| | Leakage current : ≤ Initial specified value | | | |
| | Cap. change : within ±20% of the initial measured value | | | |
| | tan δ : ≤ 200% of the initial specified value | | | |
| Industrial Standard | JIS C - 5101-4 (IEC 60384-4) | | | |

RIPPLE CURRENT MULTIPLIER

Frequency Coefficient

| Coefficient Rated Voltage | Freq. (Hz) | Coefficient | | | | |
|------------------------------|------------|-------------|------|------|------|------|
| | | 50 | 120 | 300 | 1k | 10k~ |
| <160V | | 0.80 | 1.00 | 1.08 | 1.15 | 1.15 |
| ≥160V | | 0.80 | 1.00 | 1.08 | 1.15 | 1.20 |

PART NUMBER SYSTEM (EXAMPLE : 200V 1000μF)

| 1 | 2 3 | 4 5 6 | 7 | 8 9 | 10 | 11 12 | 13 14 | |
|---|-----|-------|---|-----|----|-------|-------|----------------------|
| E | WB | 108 | M | 2D | Q | 80 | OO | |
| | | | | | | | | Type (Terminal Code) |
| | | | | | | | | Case Length (80mm) |
| | | | | | | | | Diameter (35mm) |
| | | | | | | | | Voltage (200V) |
| | | | | | | | | Tolerance (±20%) |
| | | | | | | | | Capacitance (1000μF) |
| | | | | | | | | Series |
| | | | | | | | | E-CAP |

CASE SIZE TABLE



Dimensions of mounting bracket

| Voltage (Code) | | 3 - Leg | | | | 2 - Leg | | | | |
|----------------|----------|---------|------|------|------|---------|------|------|------|-----|
| Symbol | ϕD | 51 | 63.5 | 76 | 90 | 35 | 51 | 63.5 | 76 | 90 |
| P | | 32.5 | 38.1 | 44.5 | 50.8 | 24 | 33.2 | 40.5 | 46.5 | 53 |
| A | | 38.5 | 43 | 49.2 | 58.5 | 29 | 40 | 46.5 | 53 | 59 |
| T | | 7.5 | 8.0 | 7.0 | 8.0 | 6.0 | 6.0 | 7.0 | 6.0 | 6.0 |
| S | | 5.0 | 5.0 | 5.0 | 5.0 | 3.5 | 4.5 | 4.5 | 4.5 | 4.5 |
| U | | 12 | 14 | 14 | 18 | 10 | 14 | 14 | 14 | 14 |
| θ° | | 60 | 60 | 60 | 60 | 30 | 30 | 30 | 30 | 30 |
| H | | 20 | 25 | 30 | 35 | 15 | 25 | 35 | 35 | 35 |
| h | | 15 | 20 | 24 | 25 | 10 | 15 | 20 | 20 | 20 |

STANDARD RATINGS

| Voltage (Code) | | 160V (2C) | | | 200V (2D) | | | 250V (2E) | | |
|----------------|------|------------|-------|----------------|------------|-------|----------------|------------|-------|----------------|
| SV | | 200 | | | 250 | | | 300 | | |
| Cap. (μF) | Code | Case Size | tan δ | Ripple Current | Case Size | tan δ | Ripple Current | Case Size | tan δ | Ripple Current |
| 330 | 337 | | | | | | | 35 x 50 | 0.15 | 0.7 |
| 390 | 397 | | | | | | | 35 x 80 | 0.15 | 0.8 |
| 470 | 477 | | | | 35 x 50 | 0.15 | 0.9 | 35 x 80 | 0.15 | 0.9 |
| 560 | 567 | | | | 35 x 80 | 0.15 | 1.0 | 35 x 80 | 0.15 | 1.0 |
| 680 | 687 | 35 x 50 | 0.15 | 1.1 | 35 x 80 | 0.15 | 1.1 | 35 x 100 | 0.15 | 1.2 |
| 820 | 827 | 35 x 80 | 0.15 | 1.2 | 35 x 80 | 0.15 | 1.3 | 35 x 100 | 0.15 | 1.4 |
| 1000 | 108 | 35 x 80 | 0.15 | 1.3 | 35 x 80 | 0.15 | 1.5 | 35 x 120 | 0.15 | 1.6 |
| 1200 | 128 | 35 x 80 | 0.15 | 1.5 | 35 x 100 | 0.15 | 1.7 | 51 x 80 | 0.15 | 1.8 |
| 1500 | 158 | 35 x 80 | 0.15 | 1.7 | 35 x 120 | 0.15 | 1.9 | 51 x 100 | 0.15 | 2.2 |
| 1800 | 188 | 35 x 100 | 0.15 | 2.0 | 35 x 120 | 0.15 | 2.2 | 51 x 120 | 0.15 | 2.6 |
| 2200 | 228 | 35 x 120 | 0.15 | 2.3 | 51 x 80 | 0.15 | 2.7 | 51 x 120 | 0.15 | 2.8 |
| 2700 | 278 | 35 x 120 | 0.15 | 2.7 | 51 x 100 | 0.15 | 3.2 | 63.5 x 100 | 0.15 | 3.3 |
| 3300 | 338 | 51 x 100 | 0.15 | 3.3 | 51 x 120 | 0.15 | 3.5 | 63.5 x 120 | 0.15 | 4.0 |
| 3900 | 398 | 51 x 120 | 0.15 | 3.8 | 63.5 x 100 | 0.15 | 4.0 | 76 x 100 | 0.15 | 4.4 |
| 4700 | 478 | 51 x 120 | 0.15 | 4.2 | 63.5 x 120 | 0.15 | 4.7 | 76 x 120 | 0.15 | 5.2 |
| 5600 | 568 | 51 x 120 | 0.15 | 4.7 | 76 x 100 | 0.15 | 5.3 | 76 x 140 | 0.15 | 6.1 |
| 6800 | 688 | 63.5 x 120 | 0.15 | 5.7 | 76 x 120 | 0.15 | 6.3 | 90 x 140 | 0.15 | 7.4 |
| 8200 | 828 | 76 x 100 | 0.20 | 6.4 | 76 x 140 | 0.20 | 6.4 | | | |
| 10000 | 109 | 76 x 120 | 0.20 | 6.6 | 90 x 140 | 0.20 | 7.7 | | | |
| 12000 | 129 | 76 x 140 | 0.20 | 7.8 | | | | | | |
| 15000 | 159 | 90 x 140 | 0.20 | 9.5 | | | | | | |

Maximum Allowable Ripple Current (Arms) at 125°C 120Hz
tan δ at 20°C 120Hz

Case Size ΦD x L (mm)

| Voltage (Code) | | 350V (2V) | | | 400V (2G) | | |
|----------------|------|------------|-------|----------------|------------|-------|----------------|
| SV | | 400 | | | 450 | | |
| Cap. (μF) | Code | Case Size | tan δ | Ripple Current | Case Size | tan δ | Ripple Current |
| 680 | 687 | | | | 51 x 80 | 0.25 | 3.0 |
| 820 | 827 | 51 x 80 | 0.25 | 3.3 | | | |
| 1200 | 128 | | | | 51 x 100 | 0.25 | 4.7 |
| 1500 | 158 | 51 x 100 | 0.25 | 5.2 | | | |
| 1800 | 188 | | | | 63.5 x 90 | 0.25 | 6.3 |
| 2200 | 228 | 63.5 x 90 | 0.25 | 7.0 | 63.5 x 110 | 0.25 | 7.5 |
| 2700 | 278 | 63.5 x 110 | 0.25 | 8.4 | 63.5 x 120 | 0.25 | 8.8 |
| 3300 | 338 | 63.5 x 120 | 0.25 | 9.9 | 63.5 x 140 | 0.25 | 10.5 |
| | | | | | 76 x 110 | 0.25 | 9.9 |
| 3900 | 398 | 63.5 x 140 | 0.25 | 11.5 | | | |
| | | 76 x 110 | 0.25 | 10.8 | | | |
| 4700 | 478 | | | | 63.5 x 150 | 0.25 | 13.4 |
| 5600 | 568 | 76 x 150 | 0.25 | 14.7 | | | |
| 6800 | 688 | 76 x 170 | 0.25 | 16.8 | 76 x 190 | 0.25 | 17.9 |
| | | | | | 90 x 160 | 0.25 | 17.2 |
| 8200 | 828 | 76 x 190 | 0.25 | 19.6 | 90 x 190 | 0.25 | 20.1 |
| 10000 | 109 | 90 x 190 | 0.25 | 23.0 | | | |

Maximum Allowable Ripple Current (Arms) at 125°C 120Hz
tan δ at 20°C 120Hz

Case Size ΦD x L (mm)

Specifications are subject to change without notice. Should a safety or technical concern arise regarding the product, please be sure to contact our sales offices or agents immediately.

PACKAGING SPECIFICATIONS

| | | | | | | | | | | | |
|--|---|---|----|----|-----|----|----|----|----|--|--|
| | Specifications | Quantity | | | | | | | | | |
| | $\phi 4 \times 5.4$ $\phi 5 \sim 6.3 \times 5.4 \sim 7.7$ $\phi 8 \times 6.2$ $\phi 8 \sim 10 \times 10.2$ $\phi 12.5 \times 13.5$ $\phi 12.5 \times 16$ $\phi 16 \times 16.5$ $\phi 16 \times 21.5$ | 2,000 pcs 1,000 pcs 1,000 pcs 500 pcs 200 pcs 150 pcs 125 pcs 75 pcs | | | | | | | | | |
| | | ϕD | 4 | 5 | 6.3 | 8 | 10 | 12 | 16 | | |
| | | A | 14 | 14 | 18 | 26 | 26 | 34 | 46 | | |

TAPING DIMENSIONS



| Specifications | W ± 0.30 | A | B | P ₁ ± 0.10 | F ± 0.10 | t ₂ |
|-------------------------|-----------------|------|------|------------------------------|-----------------|----------------|
| $\phi 4 \times 5.4$ | 12.0 | 4.7 | 4.7 | 8.0 | 5.5 | 5.8 |
| $\phi 5 \times 5.4$ | 12.0 | 6.0 | 6.0 | 12.0 | 5.5 | 5.8 |
| $\phi 6.3 \times 5.4$ | 16.0 | 7.0 | 7.0 | 12.0 | 7.5 | 5.8 |
| $\phi 6.3 \times 7.7$ | 16.0 | 7.0 | 7.0 | 12.0 | 7.5 | 8.3 |
| $\phi 8 \times 6.2$ | 16.0 | 8.7 | 8.7 | 12.0 | 7.5 | 6.8 |
| $\phi 8 \times 10.2$ | 24.0 | 8.7 | 8.7 | 16.0 | 11.5 | 11.0 |
| $\phi 10 \times 10.2$ | 24.0 | 10.7 | 10.7 | 16.0 | 11.5 | 11.0 |
| $\phi 12.5 \times 13.5$ | 32.0 | 13.4 | 13.4 | 24 | 14.2 | 14.4 |
| $\phi 12.5 \times 16$ | 32.0 | 13.4 | 13.4 | 24 | 14.2 | 16.3 |
| $\phi 16 \times 16.5$ | 44.0 | 17.5 | 17.5 | 28 | 20.2 | 17.4 |
| $\phi 16 \times 21.2$ | 44.0 | 17.5 | 17.5 | 28 | 20.2 | 22.4 |

REFLOW SOLDERING FOR CHIP CAPACITORS



ALLOWABLE RANGE OF PEAK TEMPERATURE

| Size | T (°C) | t (second) | t ₁ (second) |
|-------------------|--------|------------|-------------------------|
| $\phi 4 \phi 6.3$ | 255 | 100 | 50 |
| $\phi 8$ | 245 | 100 | 40 |
| $\phi 10 \phi 16$ | 245 | 100 | 40 |

RECOMMENDED LAND SIZE

| Size | mm | | |
|-------------|-----|-----|-----|
| | X | Y | a |
| $\phi 4$ | 1.6 | 2.6 | 1.0 |
| $\phi 5$ | 1.6 | 3.0 | 1.4 |
| $\phi 6.3$ | 1.6 | 3.5 | 2.1 |
| $\phi 8$ | 2.5 | 3.5 | 3.0 |
| $\phi 10$ | 2.5 | 4.0 | 4.5 |
| $\phi 12.5$ | 2.5 | 6.0 | 5.0 |
| $\phi 16$ | 3.0 | 6.5 | 8.0 |

- Preheat shall be done 100°C-200°C and for maximum 180 seconds.
- The temperature at capacitor top shall not exceed +255°C.
- The duration for over +200°C temperature at capacitor top shall not exceed 110 seconds.
- If capacitors are subject to the conditions other than the allowable range of reflow. Please contact us.

FEATURES

- Reflow soldering is available
- Available for high density surface mounting
- High stability and reliability
- Life time: 85°C, 2,000Hrs



SPECIFICATIONS

| Item | Performance Characteristics | | | | | | |
|---------------------------------|---|---|------|---|------|------|------|
| Operating Temperature Range | -40 to +85°C | | | | | | |
| Rated Working Voltage Range | 6.3 to 50V | | | | | | |
| Nominal Capacitance Range | 0.1 to 1500μF | | | | | | |
| Capacitance Tolerance | ±20% at 120Hz, +20°C | | | | | | |
| Leakage Current | I ≤ 0.01CV or 3(μA) whichever is greater measure after 2 minutes application of rated working voltage at +20°C | | | | | | |
| tanδ (120Hz, +20°C) | Working Voltage (V) | 6.3 | 10 | 16 | 25 | 35 | 50 |
| | tanδ (max.) φ4-6.3 | 0.26 | 0.22 | 0.18 | 0.16 | 0.13 | 0.12 |
| | φ8-10 | 0.35 | 0.26 | 0.20 | 0.16 | 0.14 | 0.12 |
| Low Temperature Characteristics | Impedance ratio max. at 120Hz | | | | | | |
| | Working Voltage (V) | 6.3 | 10 | 16 | 25 | 35 | 50 |
| | Z-40°C / Z+20°C | 8 | 8 | 4 | 4 | 3 | 3 |
| High Temperature Loading | Test time | : 2,000 hours | | Post test requirements at +20°C | | | |
| | Test temperature | : +85°C | | Leakage current : ≤ Initial specified value | | | |
| | Test conditions | : Rated DC working voltage | | Cap. change : within ±20% of the initial measured value | | | |
| | | | | tanδ : ≤ 200% of the initial specified value | | | |
| Shelf Life | At +85°C no voltage applied after 1,000 hours and then being stabilized at +20°C the capacitors shall meet the following limits | | | | | | |
| | Leakage current | : ≤ 200% of initial specified value | | | | | |
| | Cap. change | : within ±20% of the initial measured value | | | | | |
| | tanδ | : ≤ 200% of the initial specified value | | | | | |
| Industrial Standard | JIS C - 5101-4 (IEC 60384-4) | | | | | | |

DIMENSIONS & MARKING



| Size | φ4 x 5.4 | φ5 x 5.4 | φ6.3 x 5.4 | φ6.3 x 7.7 | φ8 x 10.2 | φ10 x 10.2 |
|------|-----------|----------|------------|------------|-----------|------------|
| A | 1.8 | 2.1 | 2.4 | 2.5 | 2.9 | 3.2 |
| B | 4.3 | 5.3 | 6.6 | 6.6 | 8.3 | 10.3 |
| C | 4.3 | 5.3 | 6.6 | 6.6 | 8.3 | 10.3 |
| E | 1.0 | 1.3 | 2.2 | 2.2 | 3.1 | 4.5 |
| L | 5.4 | 5.4 | 5.4 | 7.7 | 10.2 | 10.2 |
| H | 0.5 - 0.9 | | | | 0.9 - 1.1 | |



PART NUMBER SYSTEM (EXAMPLE: 16V 470µF)



STANDARD RATINGS

| Voltage (Code) | | 6.3V (0J) | | 10V (1A) | | 16V (1C) | | 25V (1E) | |
|----------------|------|-----------|----------------|-----------|----------------|-----------|----------------|-----------|----------------|
| Cap. (µF) | Code | Case Size | Ripple Current | Case Size | Ripple Current | Case Size | Ripple Current | Case Size | Ripple Current |
| 4.7 | 475 | | | | | | | 4 x 5.4 | 16 |
| 10 | 106 | | | | | 4 x 5.4 | 23 | 4 x 5.4 | 24 |
| 22 | 226 | 4 x 5.4 | 28 | 4 x 5.4 | 30 | 5 x 5.4 | 37 | 5 x 5.4 | 38 |
| 33 | 336 | 5 x 5.4 | 37 | 5 x 5.4 | 41 | 5 x 5.4 | 44 | 6.3 x 5.4 | 52 |
| 47 | 476 | 5 x 5.4 | 45 | 6.3 x 5.4 | 52 | 5 x 5.4 | 48 | 6.3 x 5.4 | 60 |
| | | | | | | 6.3 x 5.4 | 58 | | |
| 100 | 107 | 5 x 5.4 | 50 | 6.3 x 5.4 | 76 | 6.3 x 5.4 | 86 | 6.3 x 7.7 | 130 |
| | | 6.3 x 5.4 | 70 | | | | | | |
| 220 | 227 | 6.3 x 5.4 | 95 | 6.3 x 7.7 | 150 | 6.3 x 7.7 | 150 | 8 x 10.2 | 232 |
| 330 | 337 | 6.3 x 7.7 | 150 | 8 x 10.2 | 240 | 8 x 10.2 | 270 | 10 x 10.2 | 305 |
| 470 | 477 | 8 x 10.2 | 265 | 8 x 10.2 | 290 | 8 x 10.2 | 280 | 10 x 10.2 | 393 |
| | | | | | | 10 x 10.2 | 330 | | |
| 1000 | 108 | 10 x 10.2 | 400 | 10 x 10.2 | 454 | | | | |
| 1500 | 158 | 10 x 10.2 | 489 | | | | | | |

Maximum Allowable Ripple Current (mA rms) at 85°C 120Hz

Case Size Φ D x L (mm)

| Voltage (Code) | | 35V (1V) | | 50V (1H) | |
|----------------|------|-----------|----------------|-----------|----------------|
| Cap. (µF) | Code | Case Size | Ripple Current | Case Size | Ripple Current |
| 0.1 | 104 | | | 4 x 5.4 | 1.0 |
| 0.22 | 224 | | | 4 x 5.4 | 2.0 |
| 0.33 | 334 | | | 4 x 5.4 | 2.8 |
| 0.47 | 474 | | | 4 x 5.4 | 4.0 |
| 1 | 105 | | | 4 x 5.4 | 8.4 |
| 2.2 | 225 | | | 4 x 5.4 | 13 |
| 3.3 | 335 | 4 x 5.4 | 18 | 4 x 5.4 | 17 |
| 4.7 | 475 | 4 x 5.4 | 20 | 5 x 5.4 | 20 |
| 10 | 106 | 5 x 5.4 | 29 | 6.3 x 5.4 | 33 |
| 22 | 226 | 6.3 x 5.4 | 46 | 6.3 x 5.4 | 43 |
| 33 | 336 | 6.3 x 5.4 | 53 | 6.3 x 7.7 | 85 |
| 47 | 476 | 6.3 x 5.4 | 55 | 6.3 x 7.7 | 90 |
| | | 6.3 x 7.7 | 70 | 8 x 10.2 | 140 |
| 100 | 107 | 6.3 x 7.7 | 80 | 8 x 10.2 | 145 |
| | | 8 x 10.2 | 175 | 10 x 10.2 | 195 |
| 220 | 227 | 8 x 10.2 | 185 | 10 x 10.2 | 415 |
| | | 10 x 10.2 | 265 | | |
| 330 | 337 | 10 x 10.2 | 324 | | |
| 470 | 477 | 10 x 10.2 | 395 | | |

Maximum Allowable Ripple Current (mA rms) at 85°C 120Hz

Case Size Φ D x L (mm)

Specifications are subject to change without notice. Should a safety or technical concern arise regarding the product, please be sure to contact our sales offices or agents immediately.

FEATURES

- Operating over wide temperature range
- Reflow soldering is available
- Available for high density surface mounting
- High stability and reliability



SPECIFICATIONS

| Item | Performance Characteristics | | | | | | | |
|---------------------------------|---|----------------------------|------|------|------|------|---|--|
| Operating Temperature Range | -55 to +105°C | | | | | | | |
| Rated Working Voltage Range | 6.3 to 50V | | | | | | | |
| Nominal Capacitance Range | 0.1 to 220μF | | | | | | | |
| Capacitance Tolerance | ±20% at 120Hz, +20°C | | | | | | | |
| Leakage Current | I ≤ 0.01CV or 3(μA) whichever is greater measure after 2 minutes application of rated working voltage at +20°C | | | | | | | |
| tan δ (120Hz, +20°C) | Working Voltage (V) | 6.3 | 10 | 16 | 25 | 35 | 50 | |
| | tanδ | 0.26 | 0.20 | 0.16 | 0.14 | 0.12 | 0.12 | |
| Low Temperature Characteristics | Impedance ratio max. at 120Hz | | | | | | | |
| | Working Voltage (V) | 6.3 | 10 | 16 | 25 | 35 | 50 | |
| | Z-25°C / Z+20°C | 4 | 3 | 2 | 2 | 2 | 2 | |
| High Temperature Loading | Test time | : 1,000 hours | | | | | Post test requirements at +20°C | |
| | Test temperature | : +105°C | | | | | Leakage current : ≤ Initial specified value | |
| Shelf Life | Test conditions | : Rated DC working voltage | | | | | Cap. change : within ±20% of the initial measured value | |
| | | | | | | | tan δ : ≤ 200% of the initial specified value | |
| Industrial Standard | JIS C - 5101-4 (IEC 60384-4) | | | | | | | |

DIMENSIONS & MARKING



| Size | Φ4 x 5.4 | Φ5 x 5.4 | Φ6.3 x 5.4 |
|------|-----------|----------|------------|
| A | 1.8 | 2.1 | 2.4 |
| B | 4.3 | 5.3 | 6.6 |
| C | 4.3 | 5.3 | 6.6 |
| E | 1.0 | 1.3 | 2.2 |
| L | 5.4 | 5.4 | 5.4 |
| H | 0.5 ~ 0.9 | | |

PART NUMBER SYSTEM (EXAMPLE: 16V 100μF)

| | | | | | | | |
|---|----|-----|---|----|----|-------|-------|
| 1 | 23 | 456 | 7 | 89 | 10 | 11 12 | 13 14 |
| V | T1 | 107 | M | 1C | E | 54 | TR |



STANDARD RATINGS

| Voltage (Code) | | 6.3V (0J) | | 10V (1A) | | 16V (1C) | | 25V (1E) | |
|----------------|------|-----------|----------------|-----------|----------------|-----------|----------------|-----------|----------------|
| Cap. (μF) | Code | Case Size | Ripple Current | Case Size | Ripple Current | Case Size | Ripple Current | Case Size | Ripple Current |
| 4.7 | 475 | | | | | 4 x 5.4 | 12 | 4 x 5.4 | 13 |
| 10 | 106 | | | | | 4 x 5.4 | 20 | 4 x 5.4 | 14 |
| | | | | | | 5 x 5.4 | 20 | 5 x 5.4 | 20 |
| 22 | 226 | 4 x 5.4 | 20 | 4 x 5.4 | 21 | 4 x 5.4 | 22 | 5 x 5.4 | 25 |
| | | | | 5 x 5.4 | 27 | 5 x 5.4 | 31 | 6.3 x 5.4 | 36 |
| 33 | 336 | 4 x 5.4 | 22 | 4 x 5.4 | 23 | 5 x 5.4 | 28 | 5 x 5.4 | 29 |
| | | 5 x 5.4 | 27 | 5 x 5.4 | 34 | 6.3 x 5.4 | 40 | 6.3 x 5.4 | 44 |
| 47 | 476 | 4 x 5.4 | 25 | 5 x 5.4 | 30 | 5 x 5.4 | 31 | 6.3 x 5.4 | 48 |
| | | 5 x 5.4 | 37 | 6.3 x 5.4 | 41 | 6.3 x 5.4 | 56 | | |
| 100 | 107 | 5 x 5.4 | 39 | 6.3 x 5.4 | 53 | 6.3 x 5.4 | 75 | | |
| | | 6.3 x 5.4 | 57 | | | | | | |
| 220 | 227 | 6.3 x 5.4 | 67 | | | | | | |

Maximum Allowable Ripple Current (mA rms) at 105°C 120Hz

Case Size Φ D x L (mm)

| Voltage (Code) | | 35V (1V) | | 50V (1H) | |
|----------------|------|-----------|----------------|-----------|----------------|
| Cap. (μF) | Code | Case Size | Ripple Current | Case Size | Ripple Current |
| 0.1 | 104 | | | 4 x 5.4 | 1.0 |
| 0.22 | 224 | | | 4 x 5.4 | 2.0 |
| 0.33 | 334 | | | 4 x 5.4 | 3.0 |
| 0.47 | 474 | | | 4 x 5.4 | 4.0 |
| 1 | 105 | | | 4 x 5.4 | 8.0 |
| 2.2 | 225 | | | 4 x 5.4 | 11 |
| 3.3 | 335 | | | 4 x 5.4 | 13 |
| 4.7 | 475 | 4 x 5.4 | 14 | 5 x 5.4 | 18 |
| 10 | 106 | 5 x 5.4 | 24 | 6.3 x 5.4 | 28 |
| | | 5 x 5.4 | 27 | | |
| 22 | 226 | 6.3 x 5.4 | 40 | 6.3 x 5.4 | 42 |
| 33 | 336 | 6.3 x 5.4 | 50 | | |

Maximum Allowable Ripple Current (mArms) at 105°C 120Hz

Case Size Φ D x L (mm)

Specifications are subject to change without notice. Should a safety or technical concern arise regarding the product, please be sure to contact our sales offices or agents immediately.

FEATURES

- Life time: 105°C, 2,000Hrs
- Reflow soldering is available
- Available for high density surface mounting
- High stability and reliability



SPECIFICATIONS

| Item | Performance Characteristics |
|---------------------------------|--|
| Operating Temperature Range | -55 to +105°C |
| Rated Working Voltage Range | 6.3 to 100V |
| Nominal Capacitance Range | 4.7 to 1500μF |
| Capacitance Tolerance | ±20% at 120Hz, +20°C |
| Leakage Current | I ≤ 0.01CV or 3(μA) whichever is greater measure after 2 minutes application of rated working voltage at +20°C |
| tanδ (120Hz, +20°C) | Working Voltage (V) |
| | tanδ (max.) |
| Low Temperature Characteristics | Impedance ratio max. at 120Hz |
| | Working Voltage (V) |
| | Z-25°C / Z+20°C |
| High Temperature Loading | Test time : 2,000 hours |
| | Test temperature : +105°C |
| Shelf Life | At +105°C no voltage applied after 1,000 hours and then being stabilized at +20°C the capacitors shall meet the following limits |
| | Leakage current : ≤ Initial specified value |
| Industrial Standard | JIS C - 5101-4 (IEC 60384-4) |

DIMENSIONS & MARKING

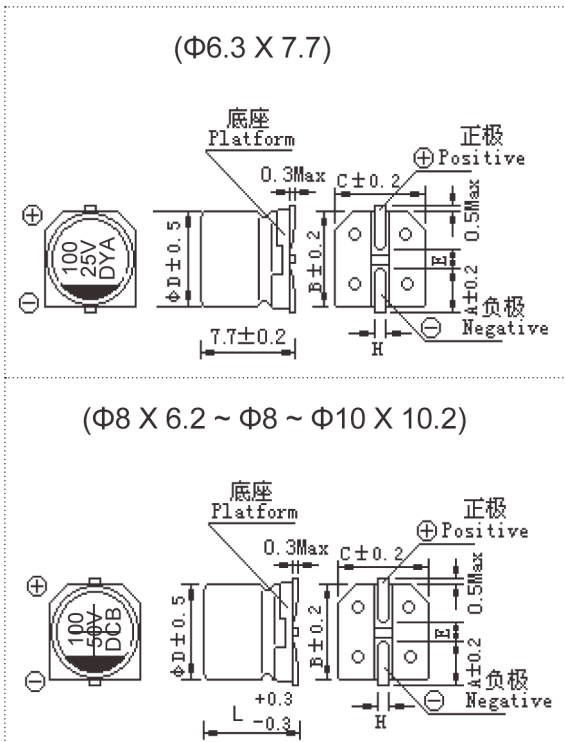

| Size | Φ6.3 x 7.7 | Φ8 x 6.2 | Φ8 x 10.2 | Φ10 x 10.2 |
|------|------------|----------|-----------|------------|
| A | 2.5 | 2.9 | 2.9 | 3.2 |
| B | 6.6 | 8.3 | 8.3 | 10.3 |
| C | 6.6 | 8.3 | 8.3 | 10.3 |
| E | 2.2 | 3.1 | 3.1 | 4.5 |
| L | 7.7 | 6.2 | 10.2 | 10.2 |
| H | 0.5 - 0.9 | | 0.8 ~ 1.1 | |

PART NUMBER SYSTEM (EXAMPLE: 25V 470µF)

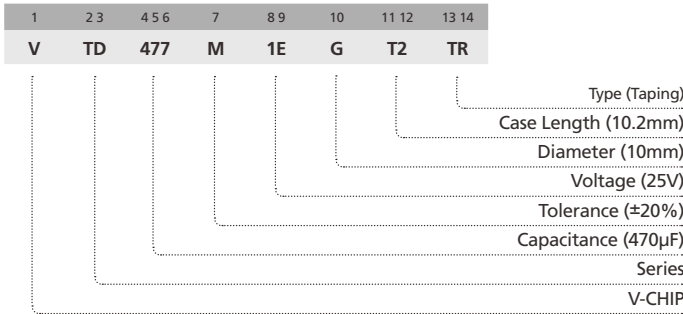

STANDARD RATINGS

| Voltage (Code) | | 6.3V (0J) | | 10V (1A) | | 16V (1C) | | 25V (1E) | |
|----------------|------|-----------|----------------|-----------|----------------|-----------|----------------|-----------|----------------|
| Cap. (µF) | Code | Case Size | Ripple Current | Case Size | Ripple Current | Case Size | Ripple Current | Case Size | Ripple Current |
| 100 | 107 | | | | | | | 6.3 x 7.7 | 91 |
| | | | | | | | | 8 x 6.2 | 105 |
| 220 | 227 | 6.3 x 7.7 | 105 | 6.3 x 7.7 | 110 | 6.3 x 7.7 | 105 | 8 x 10.2 | 175 |
| | | 8 x 6.2 | 115 | 8 x 6.2 | 120 | 8 x 6.2 | 125 | | |
| 330 | 337 | 6.3 x 7.7 | 110 | 8 x 10.2 | 196 | 8 x 10.2 | 195 | 10 x 10.2 | 240 |
| | | 8 x 6.2 | 120 | | | | | 8 x 10.2 | 220 |
| 470 | 477 | 8 x 10.2 | 210 | 8 x 10.2 | 210 | 10 x 10.2 | 295 | 10 x 10.2 | 280 |
| | | | | | | 8 x 10.2 | 230 | | |
| 1000 | 108 | 10 x 10.2 | 300 | 10 x 10.2 | 315 | 10 x 10.2 | 340 | | |
| | | 8 x 10.2 | 230 | | | | | | |
| 1500 | 158 | 10 x 10.2 | 315 | 10 x 12 | 350 | | | | |

Maximum Allowable Ripple Current (mA rms) at 105°C 120Hz

Case Size Φ D x L (mm)

| Voltage (Code) | | 35V (1V) | | 50V (1H) | | 63V (1J) | | 100V (2A) | |
|----------------|------|-----------|----------------|-----------|----------------|-----------|----------------|-----------|----------------|
| Cap. (µF) | Code | Case Size | Ripple Current | Case Size | Ripple Current | Case Size | Ripple Current | Case Size | Ripple Current |
| 4.7 | 475 | | | | | | | 6.3 x 7.7 | 35 |
| | | | | | | | | 8 x 6.2 | 40 |
| 10 | 106 | | | | | 6.3 x 7.7 | 39 | 8 x 10.2 | 77 |
| | | | | | | 8 x 6.2 | 45 | 6.3 x 7.7 | 35 |
| 22 | 226 | | | 6.3 x 7.7 | 51 | 6.3 x 7.7 | 48 | 10 x 10.2 | 126 |
| | | | | 8 x 6.2 | 54 | | | 8 x 10.2 | 84 |
| 33 | 336 | 8 x 6.2 | 50 | 6.3 x 7.7 | 60 | 8 x 10.2 | 98 | 10 x 10.2 | 133 |
| | | | | | | 6.3 x 7.7 | 49 | | |
| 47 | 476 | 6.3 x 7.7 | 70 | 8 x 10.2 | 120 | 10 x 10.2 | 160 | 10 x 10.2 | 140 |
| | | 8 x 6.2 | 78 | 6.3 x 7.7 | 75 | 8 x 10.2 | 119 | | |
| 100 | 107 | 8 x 10.2 | 120 | 10 x 10.2 | 170 | 10 x 10.2 | 196 | | |
| | | 6.3 x 7.7 | 84 | 8 x 10.2 | 140 | | | | |
| 220 | 227 | 10 x 10.2 | 220 | 10 x 10.2 | 220 | | | | |
| | | 8 x 10.2 | 190 | | | | | | |
| 330 | 337 | 10 x 10.2 | 245 | | | | | | |
| 470 | 477 | 10 x 12 | 280 | | | | | | |

Maximum Allowable Ripple Current (mA rms) at 105°C 120Hz

Case Size Φ D x L (mm)

Specifications are subject to change without notice. Should a safety or technical concern arise regarding the product, please be sure to contact our sales offices or agents immediately.

FEATURES

- Life time: 105°C, 3,000Hrs
- Small size, large capacity
- High stability and reliability with high ripple current



SPECIFICATIONS

| Item | Performance Characteristics |
|---------------------------------|--|
| Operating Temperature Range | -25 to +105°C |
| Rated Working Voltage Range | 400V.DC |
| Nominal Capacitance Range | 2.2 ~ 4.7μF |
| Capacitance Tolerance | ±20% at 120Hz, +20°C |
| Leakage Current | $I \leq 0.04CV + 100(\mu A)$ after 1 minute application of rated working voltage at +20°C |
| tanδ (120Hz, +20°C) | Working Voltage (V) 400 |
| | tanδ 0.22 |
| Low Temperature Characteristics | Impedance ratio max. at 120Hz |
| | Working Voltage (V) 400 Z-25°C / Z+20°C 6 |
| High Temperature Loading | Test time : 3,000 hours Test temperature : +105°C Test conditions : Rated DC working voltage |
| | Post test requirements at +20°C Leakage current : ≤Initial specified value Cap. change : within ±20% of the initial measured value tan δ : ≤200% of the initial specified value |
| Shelf Life | At +105°C no voltage applied after 1,000 hours and then being stabilized at +20°C the capacitors shall meet the following limits |
| | Leakage current : ≤200% of initial specified value Cap. change : within ±20% of the initial measured value tanδ : ≤200% of the initial specified value |
| Industrial Standard | JIS C - 5101-4 (IEC 60384-4) |

DIMENSIONS & MARKING



| Size | Φ8 x 10.2 | Φ10 x 10.2 |
|------|-----------|------------|
| A | 2.9 | 3.2 |
| B | 8.3 | 10.3 |
| C | 8.3 | 10.3 |
| E | 3.1 | 4.5 |
| L | 10.2 | 10.2 |
| H | 0.8 ~ 1.1 | |

PART NUMBER SYSTEM (EXAMPLE: 400V 2.2μF)

| | | | | | | | |
|---|----|-----|---|----|----|-------|-------|
| 1 | 23 | 456 | 7 | 89 | 10 | 11 12 | 13 14 |
| V | TG | 225 | M | 2G | F | T2 | TR |



STANDARD RATINGS

| Voltage (Code) | | 400V (2G) | |
|----------------|------|-----------|----------------|
| Cap. (μF) | Code | Case Size | Ripple Current |
| 2.2 | 225 | 8 x 10.2 | 26 |
| 3.3 | 335 | 10 x 10.2 | 37 |
| 4.7 | 475 | 10 x 10.2 | 39 |

Maximum Allowable Ripple Current (mA rms) at 105°C 120Hz

Case Size Φ D x L (mm)

FEATURES

- Life time: 105°C, 2,000Hrs
- Reflow soldering is available
- Available for high density surface mounting
- High stability and reliability
- Low impedance



SPECIFICATIONS

| Item | Performance Characteristics | | | | | | | | | | |
|---------------------------------|--|----------------------------|------|------|------|------|---|------|------|------|--|
| Operating Temperature Range | -55 to +105°C | | | | | | | | | | |
| Rated Working Voltage Range | 6.3 to 100V | | | | | | | | | | |
| Nominal Capacitance Range | 1 to 1500μF | | | | | | | | | | |
| Capacitance Tolerance | ±20% at 120Hz, +20°C | | | | | | | | | | |
| Leakage Current | I ≤ 0.01CV or 3(μA) whichever is greater measure after 2 minutes application of rated working voltage at +20°C | | | | | | | | | | |
| tanδ (120Hz, +20°C) | Working Voltage (V) | 6.3 | 10 | 16 | 25 | 35 | 50 | 63 | 80 | 100 | |
| | tanδ (max.) | 0.22 | 0.19 | 0.16 | 0.14 | 0.12 | 0.10 | 0.08 | 0.08 | 0.08 | |
| Low Temperature Characteristics | Impedance ratio max. at 120Hz | | | | | | | | | | |
| | Working Voltage (V) | 6.3 | 10 | 16 | 25 | 35 | 50 | 63 | 80 | 100 | |
| | Z-25°C / Z+20°C | 2 | 2 | 2 | 2 | 2 | 2 | 2 | 2 | 2 | |
| | Z-40°C / Z+20°C | 3 | 3 | 3 | 3 | 3 | 3 | 3 | 3 | 3 | |
| High Temperature Loading | Test time | : 2,000 hours | | | | | Post test requirements at +20°C | | | | |
| | Test temperature | : +105°C | | | | | Leakage current : ≤ Initial specified value | | | | |
| Shelf Life | Test conditions | : Rated DC working voltage | | | | | Cap. change : within ±20% of the initial measured value (≤16V: within ±25%) | | | | |
| | | | | | | | tanδ : ≤200% of the initial specified value | | | | |
| Industrial Standard | At +105°C no voltage applied after 1,000 hours and then being stabilized at +20°C the capacitors shall meet the following limits Leakage current : ≤200% of initial specified value Cap. change : within ±20% of the initial measured value tanδ : ≤120% of the initial specified value | | | | | | | | | | |
| | JIS C - 5101-4 (IEC 60384-4) | | | | | | | | | | |

DIMENSIONS & MARKING



| Size | Φ4x5.4 | Φ5x5.4 | Φ6.3x5.4 | Φ6.3x7.7 | Φ8x6.2 | Φ8x10.2 | Φ10x10.2 |
|------|-----------|--------|----------|-----------|--------|---------|----------|
| A | 1.8 | 2.2 | 2.6 | 2.6 | 2.9 | 2.9 | 3.3 |
| B | 4.3 | 5.3 | 6.6 | 6.6 | 8.3 | 8.3 | 10.3 |
| C | 4.3 | 5.3 | 6.6 | 6.6 | 8.3 | 8.3 | 10.3 |
| L | 5.4 | 5.4 | 5.4 | 7.7 | 6.2 | 10.2 | 10.2 |
| H | 0.5 - 0.9 | | | 0.9 - 1.1 | | | |

PART NUMBER SYSTEM (EXAMPLE: 25V 470µF)



STANDARD RATINGS

| Voltage (Code) | | 6.3V (0J) | | | 10V (1A) | | | 16V (1C) | | | 25V (1E) | | | 35V (1V) | | |
|----------------|------|-----------|-----------|----------------|-----------|-----------|----------------|-----------|-----------|----------------|-----------|-----------|----------------|-----------|-----------|----------------|
| Cap. (µF) | Code | Case Size | Impedance | Ripple Current | Case Size | Impedance | Ripple Current | Case Size | Impedance | Ripple Current | Case Size | Impedance | Ripple Current | Case Size | Impedance | Ripple Current |
| 4.7 | 475 | | | | | | | | | | 4 x 5.4 | 2.2 | 80 | 4 x 5.4 | 2.2 | 80 |
| 10 | 106 | | | | | | | 4 x 5.4 | 2.2 | 80 | 4 x 5.4 | 2.2 | 80 | 5 x 5.4 | 1.2 | 150 |
| 22 | 226 | 4 x 5.4 | 2.2 | 80 | 4 x 5.4 | 2.2 | 80 | 5 x 5.4 | 1.2 | 150 | 6.3 x 5.4 | 0.58 | 230 | 6.3 x 5.4 | 0.58 | 230 |
| 33 | 336 | 5 x 5.4 | 1.2 | 150 | 5 x 5.4 | 1.2 | 150 | 6.3 x 5.4 | 0.58 | 230 | 6.3 x 5.4 | 0.58 | 230 | 6.3 x 5.4 | 0.58 | 230 |
| 47 | 476 | 5 x 5.4 | 1.2 | 150 | 6.3 x 5.4 | 0.58 | 230 | 6.3 x 5.4 | 0.58 | 230 | 6.3 x 7.7 | 0.34 | 280 | 6.3 x 7.7 | 0.34 | 280 |
| 100 | 107 | 6.3 x 5.4 | 0.58 | 230 | 6.3 x 7.7 | 0.34 | 280 | 6.3 x 5.4 | 0.52 | 230 | 6.3 x 7.7 | 0.34 | 280 | 8 x 10.2 | 0.17 | 450 |
| | | | | | | | | 6.3 x 7.7 | 0.34 | 280 | 8 x 6.2 | 0.26 | 300 | | | |
| 150 | 157 | 6.3 x 5.4 | 0.58 | 230 | 6.3 x 7.7 | 0.34 | 280 | 6.3 x 7.7 | 0.34 | 280 | 8 x 10.2 | 0.17 | 450 | 10 x 10.2 | 0.1 | 670 |
| | | | | | | | | 6.3 x 5.4 | 0.58 | 243 | 6.3 x 7.7 | 0.34 | 280 | 6.3 x 7.7 | 0.34 | 384 |
| 220 | 227 | 6.3 x 7.7 | 0.34 | 280 | 8 x 10.2 | 0.17 | 450 | 8 x 10.2 | 0.17 | 450 | | | | 10 x 10.2 | 0.1 | 670 |
| 330 | 337 | 6.3 x 7.7 | 0.34 | 280 | 8 x 10.2 | 0.17 | 450 | 8 x 10.2 | 0.17 | 450 | 10 x 10.2 | 0.1 | 670 | 10 x 10.2 | 0.1 | 670 |
| 470 | 477 | 8 x 10.2 | 0.17 | 450 | 8 x 10.2 | 0.17 | 450 | 8 x 10.2 | 0.17 | 450 | 10 x 10.2 | 0.1 | 670 | 10 x 10.2 | 0.1 | 670 |
| | | | | | | | | 10 x 10.2 | 0.1 | 670 | | | | | | |
| 1000 | 108 | 8 x 10.2 | 0.17 | 450 | 10 x 10.2 | 0.1 | 670 | 10 x 10.2 | 0.1 | 670 | | | | | | |
| | | 10 x 10.2 | 0.1 | 670 | | | | | | | | | | | | |
| 1500 | 158 | 10 x 10.2 | 0.1 | 670 | | | | | | | | | | | | |

Maximum Allowable Ripple Current (mA rms) at 105°C 100kHz

Case Size Φ D x L (mm)

Maximum ESR (Ω) at 20°C 100kHz

| Voltage (Code) | | 50V (1H) | | | 63V (1J) | | | 80V(1K) | | | 100V (2A) | | |
|----------------|------|-----------|-----------|----------------|-----------|-----------|----------------|-----------|-----------|----------------|-----------|-----------|----------------|
| Cap. (µF) | Code | Case Size | Impedance | Ripple Current | Case Size | Impedance | Ripple Current | Case Size | Impedance | Ripple Current | Case Size | Impedance | Ripple Current |
| 1 | 105 | 4 x 5.4 | 4.5 | 60 | | | | | | | | | |
| 2.2 | 225 | 4 x 5.4 | 4.5 | 60 | | | | | | | | | |
| 3.3 | 335 | 4 x 5.4 | 4.5 | 60 | | | | 5 x 5.4 | 5 | 25 | | | |
| 4.7 | 475 | 5 x 5.4 | 3.5 | 85 | 5 x 5.4 | 3 | 50 | 6.3 x 5.4 | 3 | 40 | | | |
| 10 | 106 | 6.3 x 5.4 | 1.8 | 165 | 6.3 x 5.4 | 1.5 | 80 | 6.3 x 7.7 | 2.4 | 60 | | | |
| | | | | | 6.3 x 7.7 | 1.2 | 120 | | | | | | |
| 22 | 226 | 6.3 x 7.7 | 1.6 | 185 | 6.3 x 7.7 | 1.2 | 120 | 8 x 10.2 | 1.3 | 130 | 8 x 10.2 | 1.3 | 130 |
| | | | | | 8 x 6.2 | 1.2 | 120 | | | | | | |
| 33 | 336 | 6.3 x 7.7 | 1.6 | 185 | 8 x 10.2 | 0.65 | 250 | 8 x 10.2 | 1.3 | 130 | 10 x 10.2 | 0.7 | 200 |
| 47 | 476 | 8 x 10.2 | 0.4 | 300 | 8 x 10.2 | 0.65 | 250 | 10 x 10.2 | 0.7 | 200 | | | |
| | | 10 x 10.2 | 0.3 | 342 | | | | | | | | | |
| 68 | 686 | 10 x 10.2 | 0.3 | 342 | 8 x 10.2 | 0.65 | 250 | | | | | | |
| 100 | 107 | 10 x 10.2 | 0.22 | 670 | 10 x 10.2 | 0.35 | 400 | | | | | | |
| 150 | 157 | 10 x 10.2 | 0.2 | 670 | | | | | | | | | |
| 220 | 227 | 10 x 10.2 | 0.18 | 670 | | | | | | | | | |

Maximum Allowable Ripple Current (mA rms) at 105°C 100kHz

Case Size Φ D x L (mm)

Maximum ESR (Ω) at 20°C 100kHz

Specifications are subject to change without notice. Should a safety or technical concern arise regarding the product, please be sure to contact our sales offices or agents immediately.

FEATURES

- Load life of 3,000/5,000 hours at 105°C
- Reflow soldering is available
- Available for high density surface mounting



SPECIFICATIONS

| Item | Performance Characteristics | | | | | | | |
|---------------------------------|--|---|------|------|------|------|---|--|
| Operating Temperature Range | -40 to +105°C | | | | | | | |
| Rated Working Voltage Range | 6.3 to 50V | | | | | | | |
| Nominal Capacitance Range | 0.1 to 1000μF | | | | | | | |
| Capacitance Tolerance | ±20% at 120Hz, +20°C | | | | | | | |
| Leakage Current | I ≤ 0.01CV or 3(μA) whichever is greater measure after 2 minutes application of rated working voltage at +20°C | | | | | | | |
| tanδ (120Hz, +20°C) | Working Voltage (V) | 6.3 | 10 | 16 | 25 | 35 | 50 | |
| | tanδ | 0.30 | 0.24 | 0.20 | 0.16 | 0.14 | 0.14 | |
| Low Temperature Characteristics | Impedance ratio max. at 120Hz | | | | | | | |
| | Working Voltage (V) | 6.3 | 10 | 16 | 25 | 35 | 50 | |
| | Z-25°C / Z+20°C | 4 | 3 | 2 | 2 | 2 | 2 | |
| | Z-40°C / Z+20°C | 12 | 8 | 6 | 4 | 3 | 3 | |
| High Temperature Loading | Test time | : 3,000 hours (Φ4~6.3); 5,000 hours (Φ8~10) | | | | | Post test requirements at +20°C | |
| | Test temperature | : +105°C | | | | | Leakage current : ≤Initial specified value | |
| | Test conditions | : Rated DC working voltage | | | | | Cap. change : within ±30% of the initial measured value | |
| | | | | | | | tanδ : ≤300% of the initial specified value | |
| Shelf Life | At +105°C no voltage applied after 1,000 hours and then being stabilized at +20°C the capacitors shall meet the following limits | | | | | | | |
| | Leakage current | : ≤Initial specified value | | | | | | |
| | Cap. change | : within ±30% of the initial measured value | | | | | | |
| | tanδ | : ≤300% of the initial specified value | | | | | | |
| Industrial Standard | JIS C - 5101-4 (IEC 60384-4) | | | | | | | |

DIMENSIONS & MARKING

| Size | Φ4 x 6.0 | Φ5 x 6.0 | Φ6.3 x 6.0 | Φ6.3 x 8.0 | Φ8 x 10.5 | Φ10 x 10.5 |
|------|-----------|----------|------------|------------|-----------|------------|
| A | 1.8 | 2.1 | 2.4 | 2.5 | 2.9 | 3.2 |
| B | 4.3 | 5.3 | 6.6 | 6.6 | 8.3 | 10.3 |
| C | 4.3 | 5.3 | 6.6 | 6.6 | 8.3 | 10.3 |
| D | 4.0 | 5.0 | 6.3 | 6.3 | 8.0 | 10.0 |
| E | 1.0 | 1.3 | 2.2 | 2.2 | 3.1 | 4.5 |
| L | 6.0 | 6.0 | 6.0 | 8.0 | 10.5 | 10.5 |
| H | 0.5 ~ 0.9 | | | | 0.9 ~ 1.1 | |

(Φ4 ~ Φ6.3 × 6.0)

(Φ6.3 × 8.0)

(Φ8 ~ Φ10 × 10.5)

PART NUMBER SYSTEM (EXAMPLE: 25V 470µF)



STANDARD RATINGS

| Voltage (Code) | | 6.3V (0J) | | 10V (1A) | | 16V (1C) | | 25V (1E) | |
|----------------|------|-----------|----------------|-----------|----------------|-----------|----------------|-----------|----------------|
| Cap. (µF) | Code | Case Size | Ripple Current | Case Size | Ripple Current | Case Size | Ripple Current | Case Size | Ripple Current |
| 4.7 | 475 | | | | | | | 4 x 6.0 | 13 |
| 10 | 106 | | | | | 4 x 6.0 | 18 | 4 x 6.0 | 20 |
| 22 | 226 | 4 x 6.0 | 22 | 4 x 6.0 | 27 | 5 x 6.0 | 30 | 6.3 x 6.0 | 34 |
| 33 | 336 | 5 x 6.0 | 30 | 5 x 6.0 | 35 | 6.3 x 6.0 | 40 | 6.3 x 6.0 | 50 |
| 47 | 476 | 5 x 6.0 | 38 | 6.3 x 6.0 | 48 | 6.3 x 6.0 | 50 | 6.3 x 8.0 | 63 |
| 100 | 107 | 6.3 x 6.0 | 69 | 6.3 x 8.0 | 80 | 6.3 x 8.0 | 81 | 6.3 x 8.0 | 90 |
| 220 | 227 | 6.3 x 8.0 | 120 | 6.3 x 8.0 | 130 | 8 x 10.5 | 115 | 8 x 10.5 | 170 |
| 330 | 337 | 6.3 x 8.0 | 130 | 8 x 10.5 | 180 | 8 x 10.5 | 195 | 10 x 10.5 | 230 |
| 470 | 477 | 8 x 10.5 | 210 | 8 x 10.5 | 210 | 10 x 10.5 | 260 | 10 x 10.5 | 280 |
| 1000 | 108 | 10 x 10.5 | 300 | 10 x 10.5 | 300 | | | | |

Maximum Allowable Ripple Current (mA rms) at 105°C 120Hz

Case Size Φ D x L (mm)

| Voltage (Code) | | 35V (1V) | | 50V (1H) | |
|----------------|------|-----------|----------------|-----------|----------------|
| Cap. (µF) | Code | Case Size | Ripple Current | Case Size | Ripple Current |
| 0.1 | 104 | | | 4 x 6.0 | 1.0 |
| 0.22 | 224 | | | 4 x 6.0 | 2.6 |
| 0.33 | 334 | | | 4 x 6.0 | 3.2 |
| 0.47 | 474 | | | 4 x 6.0 | 4.0 |
| 1 | 105 | | | 4 x 6.0 | 8.0 |
| 2.2 | 225 | | | 4 x 6.0 | 11 |
| 3.3 | 335 | | | 4 x 6.0 | 14 |
| 4.7 | 475 | 4 x 6.0 | 16 | 5 x 6.0 | 19 |
| 10 | 106 | 5 x 6.0 | 27 | 6.3 x 6.0 | 32 |
| 22 | 226 | 6.3 x 6.0 | 44 | 6.3 x 8.0 | 58 |
| 33 | 336 | 6.3 x 8.0 | 57 | 6.3 x 8.0 | 70 |
| 47 | 476 | 6.3 x 8.0 | 68 | 8 x 10.5 | 124 |
| 100 | 107 | 8 x 10.5 | 120 | 10 x 10.5 | 200 |
| 220 | 227 | 10 x 10.5 | 220 | 10 x 10.5 | 230 |
| 330 | 337 | 10 x 10.5 | 260 | | |

Maximum Allowable Ripple Current (mA rms) at 105°C 120Hz

Case Size Φ D x L (mm)

Specifications are subject to change without notice. Should a safety or technical concern arise regarding the product, please be sure to contact our sales offices or agents immediately.



MEMO

總公司 HEAD OFFICE

香港

HONG KONG

萬裕電子有限公司

香港九龍紅磡鶴翔街8號

維港中心二期6樓03室

Man Yue Electronics Co., Ltd.

Unit 03, 6/F., Harbour Centre Tower 2,

8 Hok Cheung Street, Hung Hom,

Kowloon, Hong Kong

電話 TEL: (852) 2897 5277

傳真 FAX: (852) 2558 6299

分公司 BRANCH OFFICE

香港

HONG KONG

三信電子零件有限公司

香港九龍紅磡鶴翔街8號

維港中心二期6樓03室

Samxon Electronic Components Ltd.

Unit 03, 6/F., Harbour Centre Tower 2,

8 Hok Cheung Street, Hung Hom,

Kowloon, Hong Kong

電話 TEL: (852) 2897 5277

傳真 FAX: (852) 2558 6299

台灣

TAIWAN

香港商萬裕國際電子有限公司台灣分公司

台灣新北市23553中和區

連城路258號13樓之1

郵政編碼：23553

Man Yue Electronics Company Limited

Taiwan Branch (H.K.)

13F-1, No. 258 Liancheng Road,

Zhonghe District, New Taipei City,

Taiwan 23553, R.O.C.

Postal Code: 23553

電話 TEL: 886 (02) 8227 2227

傳真 FAX: 886 (02) 8227 2226

www.samxon.com

中國深圳 SHENZHEN, CHINA

萬晉電子(深圳)有限公司

中國深圳市羅湖區

中國深圳市羅湖區寶安南路2014號

振業大廈B座913·915房

郵政編碼：518000

Man Jin Electronics (Shenzhen) Co., Ltd.

Rm 913 & 915, Block B, 9/F., Zhenye Tower,

2014 Baoan South Road,

Luohu, Shenzhen City,

Guangdong Province, PR China

Postal Code: 518000

電話 TEL: 86 (755) 2586 2216

傳真 FAX: 86 (755) 2586 2239

中國上海 SHANGHAI, CHINA

萬發國際貿易(上海)有限公司

中國江蘇省無錫市錫山經濟開發區

東亭鎮春暉東路148號

郵政編碼：214101

Man Fat International Trading

(Shanghai) Co., Ltd.

148 Chunhui East Road, Dongting Town,

Xishan Economic Development Zone,

Wuxi, Jiangsu Province, PR China

Postal Code: 214101

電話 TEL: 86 (510) 8866 2688

傳真 FAX: 86 (510) 8865 2933

中國上海市寶山區

共和新路4995號611室

郵政編碼：200435

Room 611,

No.4995 Gong He Xin Road,

Baoshan District,

Shanghai, PR China

Postal Code: 200435

電話 TEL: 86 (021) 6639 2180

傳真 FAX: 86 (021) 6639 2180

中國廠址 PRC MANUFACTURING PLANTS

中國東莞

DONGGUAN, CHINA

萬裕三信電子(東莞)有限公司

中國廣東省東莞市長安鎮烏沙村

興發南路新星工業園

郵政編碼：523857

Samxon Electronics (Dongguan) Co., Ltd.

Xin Xing Industrial Area,

Xing Fa South Road, Wu Sha Village,

Changan Town, Dongguan,

Guangdong Province, PR China

Postal Code: 523857

電話 TEL: 86 (769) 8228 6000 / 8532 3339

傳真 FAX: 86 (769) 8541 6401

中國無錫

WUXI, CHINA

無錫萬裕電子有限公司

中國江蘇省無錫市錫山經濟開發區

東亭鎮春暉東路148號

郵政編碼：214101

Wuxi Man Yue Electronics Co., Ltd.

148 Chunhui East Road, Dongting Town,

Xishan Economic Development Zone,

Wuxi, Jiangsu Province, PR China

Postal Code: 214101

電話 TEL: 86 (510) 8866 2688

傳真 FAX: 86 (510) 8865 0388

X-ON Electronics

Largest Supplier of Electrical and Electronic Components

Click to view similar products for [Aluminium Electrolytic Capacitors - Radial Leaded](#) category:

Click to view products by [Man Yue](#) manufacturer:

Other Similar products are found below :

[LXY50VB4.7M-5X11](#) [RFO-100V471MJ7P#](#) [ECE-A1EGE220](#) [1814181](#) [NCD681K10KVY5PF](#) [NEV1000M25EF-BULK](#) [NEV100M35DC](#)
[NEV100M63DE](#) [NEV220M25DD-BULK](#) [NEV.33M100AA](#) [NEV4700M50HB](#) [NEV.47M100AA](#) [NEVH1.0M250AB](#) [NEVH3.3M250BB](#)
[NEVH3.3M450CC](#) [KME50VB100M-8X11.5](#) [SG220M1CSA-0407](#) [ES5107M016AE1DA](#) [ESX472M16B](#) [476CKH100MSA](#) [477RZS050M](#)
[UVX1V101KPA1FA](#) [UVX1V222MHA1CA](#) [KME25VB100M-6.3X11](#) [VTL100S10](#) [VTL470S10](#) [511D336M250EK5D](#) [052687X](#) [ECE-](#)
[A1CF471](#) [EKXG451ELL820MM30S](#) [686CKR050M](#) [NRE-S560M16V6.3X7TBSTF](#) [ERZA630VHN182UP54N](#) [UPL1A331MPH](#)
[NEV1000M6.3DE](#) [NEV100M16CB](#) [NEV100M50DD-BULK](#) [NEV2200M16FF](#) [NEV220M50EE](#) [NEV2.2M50AA](#) [NEV330M63EF](#)
[NEV4700M35HI](#) [NEV4.7M100BA](#) [NEV47M16BA](#) [NEV47M50CB-BULK](#) [NEVH1.0M350AB](#) [NEVH2.2M160AB](#) [NEVH3.3M350BC](#)
[TER330M50GM](#) [477KXM035MGBWSA](#)