



SAMXON

ALUMINUM ELECTROLYTIC CAPACITORS

2017-2018



QC 080000



ISO 9001

ISO 14001



ACCREDITED

002	Series Chart 產品體系圖
004	Series Table 產品一覽表
006	Application Guidelines 應用指引
015	Part Number System 產品編碼
016	Taping Specifications 編帶產品規格
017	Packing Specifications 包裝規格
018	Lead Forming Specifications 成型產品規格

Miniature Aluminum Electrolytic Capacitors 小型鋁電解電容器

019	Miniature Type 小型品
023	General Purpose 普通品
034	Low Impedance Type 低阻抗品
061	High Reliability Type 高可靠品
072	High Temperature Type 高溫度品
081	For Audio Type 音響用品
083	Non-polarized Type 無極性品
087	Pen Cap Type 筆型電容

Large Can Aluminum Electrolytic Capacitors 大型鋁電解電容器

093	Lug / Snap-in Terminal Type Case Size Table 插入/自立型產品圖解
095	Lug / Snap-in Terminal Standard Type 插入/自立型標準品
113	Lug / Snap-in Terminal High Reliability Type 插入/自立型高可靠品
146	Screw Terminal Type Case Size Table 螺釘型產品圖解
147	Screw Terminal Type 螺釘型

V-Chip Aluminum Electrolytic Capacitors 貼片式鋁電解電容器

178	Surface Mount Type Packing Specifications 貼片品包裝規格
179	Surface Mount Type 貼片品



Series Chart (產品體系圖)

Radial Lead Type

導針型

Index



Lug / Snap-in Terminal Type 插入/自立型



Screw Terminal Type 螺釘型



Surface Mount Type 貼片型



Series Table (產品一覽表)

Series	Features (特點)	Letter Color	Sleeve Color	Temp. (°C)	Voltage (VDC)	Cap. (µF)	Load Life	Page
Miniature Aluminum Electrolytic Capacitors								小型鋁電解電容器
Miniature Type								小型品
KF	5mmL (高), +105°C	White (白)	Black (黑)	-40 ~ +105	4 ~ 50	3.3 ~ 330	1,000 Hrs.	P.19
KS	7mmL (高), -40°C ~ +105°C	White (白)	Black (黑)	-40 ~ +105	6.3 ~ 50	3.3 ~ 330	1,000 Hrs.	P.21
General Purpose								普通品
GS	+85°C, General (普通品)	White (白)	Dark Blue (深藍)	-40(-25) ~ +85	6.3 ~ 450	2.2 ~ 22000	2,000 Hrs.	P.23
KM	+105°C, General (普通品)	White (白)	Black (黑)	-40(-25) ~ +105	6.3 ~ 450	0.47 ~ 33000	2,000 Hrs.	P.26
KG	-55 ~ +105°C, Wide Temperature (寬溫度)	White (白)	Black (黑)	-55 ~ +105	6.3 ~ 100	2.2 ~ 22000	1,000 ~ 2,000 Hrs.	P.30
OM	+105°C, Withstanding Overvoltage (耐過電壓品)	White (白)	Black (黑)	-25 ~ +105	200 & 400	22 ~ 330	2,000 Hrs.	P.32
Low Impedance Type								低阻抗品
GF	+105°C, High Ripple Current, Low Impedance (高紋波, 低阻抗)	White (白)	Sea Green (海綠)	-40 ~ +105	6.3 ~ 100	3.3 ~ 4700	1,000 ~ 4,000 Hrs.	P.34
SF	+105°C, High Ripple Current, Long Life Assurance, Low Impedance (高紋波, 長壽命, 低阻抗)	White (白)	Black (黑)	-40 ~ +105	6.3 ~ 100	15 ~ 3900	3,000 ~ 6,000 Hrs.	P.38
GT	+105°C, High Ripple Current, Longer Life Assurance, Low Impedance (高紋波, 較長壽命, 低阻抗)	Silver (銀)	Black (黑)	-40 ~ +105	6.3 ~ 100	15 ~ 3900	4,000 ~ 10,000 Hrs.	P.40
GK	+105°C, Higher Ripple Current, Lower Impedance (較高紋波, 較低阻抗)	White (白)	Sea Green (海綠)	-40 ~ +105	6.3 ~ 25	100 ~ 3900	2,000 ~ 5,000 Hrs.	P.43
SH	+105°C, Highest Ripple Current, Lowest Impedance, Long Life Assurance (更高紋波, 更低阻抗, 長壽命)	White (白)	Black (黑)	-40 ~ +105	6.3 ~ 50	100 ~ 8200	5,000 ~ 6,000 Hrs.	P.45
SK	+105°C, Highest Ripple Current, Longest Life Assurance, Lower Impedance (更高紋波, 更長壽命, 較低阻抗)	Silver (銀)	Black (黑)	-40 ~ +105	6.3 ~ 100	33 ~ 8200	6,000 ~ 10,000 Hrs.	P.47
RS	+105°C, High Ripple Current, Longer Life Assurance, Low Impedance (高紋波, 較長壽命, 低阻抗)	White (白)	Black (黑)	-40 ~ +105	6.3 ~ 100	15 ~ 4700	3,000 ~ 7,000 Hrs.	P.51
GY	+105°C, Longer Life Assurance, Low Impedance (較長壽命, 低阻抗)	White (白)	Black (黑)	-40 ~ +105	6.3 ~ 100	3.3 ~ 15000	4,000 ~ 10,000 Hrs.	P.55
RF	-55 ~ +105°C, Wide Temperature, High Ripple Current, Low Impedance (寬溫度, 高紋波, 低阻抗)	White (白)	Black (黑)	-55 ~ +105	6.3 ~ 100	22 ~ 4700	1,000 ~ 4,000 Hrs.	P.57
High Reliability Type								高可靠品
RR	Long Life Assurance, High Ripple Current (長壽命, 高紋波)	White (白)	Black (黑)	-40(-25) ~ +105	160 ~ 450	1 ~ 220	3,000 Hrs.	P.61
RT	Long Life Assurance, High Ripple Current (長壽命, 高紋波)	White (白)	Black (黑)	-40(-25) ~ +105	160 ~ 450	1 ~ 220	5,000 Hrs.	P.63
RE	Longer Life Assurance (較長壽命)	White (白)	Black (黑)	-25 ~ +105	160 ~ 450	1 ~ 220	8,000 ~ 10,000 Hrs.	P.66
RD	Longer Life Assurance, High Ripple Current (較長壽命, 高紋波)	White (白)	Black (黑)	-40(-25) ~ +105	160 ~ 500	1 ~ 330	8,000 ~ 10,000 Hrs.	P.68
RH	Longest Life Assurance, High Ripple Current (更長壽命, 高紋波)	White (白)	Black (黑)	-40(-25) ~ +105	160 ~ 500	1 ~ 220	10,000 ~ 12,000 Hrs.	P.70
High Temperature Type								高溫品
BD	+125°C, High Temperature (高溫度)	White (白)	Black (黑)	-40 ~ +125	10 ~ 50	3.3 ~ 3900	1,000 ~ 2,000 Hrs.	P.72
RA	+130°C, High Temperature, High Ripple Current (高溫度, 高紋波)	White (白)	Black (黑)	-40(-25) ~ +130	10 ~ 450	1 ~ 4700	1,000 ~ 4,000 Hrs.	P.74
RB	+130°C, High Temperature, High Ripple Current, Long Life Assurance (高溫度, 高紋波, 長壽命)	White (白)	Black (黑)	-40(-25) ~ +130	160 ~ 450	1.5 ~ 100	3,000 ~ 4,000 Hrs.	P.77
RC	+130°C, High Temperature, High Ripple Current, Longer Life Assurance (高溫度, 高紋波, 較長壽命)	White (白)	Black (黑)	-25 ~ +130	160 ~ 450	1.5 ~ 100	5,000 ~ 6,000 Hrs.	P.79
For Audio Type								音響用品
FA	Standard, For Audio (標準品, 音響電容)	White (白)	Coffee (咖啡)	-40 ~ +85	6.3 ~ 100	2.2 ~ 10000	1,000 Hrs.	P.81
Non-polarized Type								無極性品
NP	+85°C, Non-polar (無極性)	Black (黑)	Green (綠)	-40 ~ +85	6.3 ~ 100	2.2 ~ 6800	1,000 Hrs.	P.83
NH	+105°C, Non-polar (無極性)	White (白)	Black (黑)	-40 ~ +105	6.3 ~ 100	2.2 ~ 1000	1,000 Hrs.	P.85
Pen Cap Type								筆型電容
KM	+105°C, Pen Cap (筆型電容)	White (白)	Black (黑)	-25 ~ +105	200 ~ 450	22 ~ 270	2,000 Hrs.	P.87
RW	+105°C, Pen Cap, Long Life Assurance (筆型電容, 長壽命)	White (白)	Black (黑)	-25 ~ +105	200 ~ 450	22 ~ 220	5,000 Hrs.	P.89
RY	+105°C, Pen Cap, Longer Life Assurance (筆型電容, 較長壽命)	White (白)	Black (黑)	-25 ~ +105	200 ~ 450	22 ~ 220	10,000 Hrs.	P.91
Large Can Aluminum Electrolytic Capacitors								大型鋁電解電容器
Standard Type								標準品
LP	Lug / Snap-in Terminal Type, Standard (插入/自立型, 標準品)	White (白)	Black (黑)	-40(-25) ~ +85	10 ~ 500	56 ~ 82000	2,000 Hrs.	P.95
AP	Lug / Snap-in Terminal Type, For Audio (插入/自立型, 音響電容)	White (白)	Coffee (咖啡)	-40 ~ +85	16 ~ 100	680 ~ 10000	1,000 Hrs.	P.101
QP	Lug / Snap-in Terminal Type, Withstanding Vibration (插入/自立型, 耐振動)	White (白)	Black (黑)	-40(-25) ~ +85	10 ~ 500	56 ~ 82000	2,000 Hrs.	P.103
DP	Lug / Snap-in Terminal Type, Long Life Assurance, Low Impedance (插入/自立型, 長壽命, 低阻抗)	White (白)	Black (黑)	-40(-25) ~ +85	160 ~ 450	47 ~ 2200	5,000 Hrs.	P.109
TP	Lug / Snap-in Terminal Type, Ultra Long Life Assurance (插入/自立型, 超長壽命)	White (白)	Black (黑)	-25 ~ +85	200 ~ 450	56 ~ 2200	10,000 Hrs.	P.111

Series Table (產品一覽表)

Series	Features (特點)	Letter Color	Sleeve Color	Temp. (°C)	Voltage (VDC)	Cap. (µF)	Load Life	Page
Large Can Aluminum Electrolytic Capacitors								大型鋁電解電容器
High Reliability Type								高可靠品
HP	Lug / Snap-in Terminal Type, Wide Temperature (插入/自立型, 寬溫度)	White (白)	Black (黑)	-40(-25) ~ +105	10 ~ 500	47 ~ 56000	2,000 Hrs.	P.113
UP	Lug / Snap-in Terminal Type, Withstanding Overvoltage (插入/自立型, 耐過電壓品)	White (白)	Black (黑)	-25 ~ +105	200 ~ 450	56 ~ 1200	2,000 Hrs.	P.119
KP	Lug / Snap-in Terminal Type, Long Life Assurance (插入/自立型, 長壽命)	White (白)	Black (黑)	-40(-25) ~ +105	10 ~ 450	47 ~ 56000	3,000 Hrs.	P.121
EP	Lug / Snap-in Terminal Type, Long Life Assurance (插入/自立型, 長壽命)	White (白)	Black (黑)	-40(-25) ~ +105	10 ~ 450	82 ~ 47000	5,000 Hrs.	P.127
FP	Lug / Snap-in Terminal Type, Long Life Assurance, Low Impedance (插入/自立型, 長壽命, 低阻抗)	Silver (銀)	Black (黑)	-40(-25) ~ +105	10 ~ 450	100 ~ 33000	5,000 Hrs.	P.132
SP	Lug / Snap-in Terminal Type, Longer Life Assurance (插入/自立型, 較長壽命)	White (白)	Black (黑)	-40(-25) ~ +105	160 ~ 450	39 ~ 2200	7,000 Hrs.	P.134
VP	Lug / Snap-in Terminal Type, Withstanding Vibration (插入/自立型, 耐振動)	White (白)	Black (黑)	-40(-25) ~ +105	10 ~ 500	39 ~ 56000	2,000 Hrs.	P.137
GP	Lug / Snap-in Terminal Type, Ultra Small Size (插入/自立型, 超小體積)	White (白)	Black (黑)	-40(-25) ~ +105	160 ~ 450	100 ~ 3300	2,000 Hrs.	P.143
Screw Terminal Type								螺釘型
WR	+85°C, Screw Terminal Type, Standard (螺釘型, 標準品)	Silver (銀)	Black (黑)	-40(-25) ~ +85	10 ~ 630	100 ~ 680000	2,000 Hrs.	P.147
WI	+85°C, Screw Terminal Type, High Ripple Current (螺釘型, 高紋波)	Silver (銀)	Black (黑)	-25 ~ +85	350 ~ 450	390 ~ 22000	2,000 Hrs.	P.152
WT	+105°C, Screw Terminal Type, Standard (螺釘型, 標準品)	Silver (銀)	Black (黑)	-40(-25) ~ +105	10 ~ 500	180 ~ 680000	2,000 Hrs.	P.155
WX	+85°C, Screw Terminal Type, Long Life Assurance (螺釘型, 長壽命)	Silver (銀)	Black (黑)	-40(-25) ~ +85	10 ~ 550	1000 ~ 1500000	5,000 Hrs.	P.160
WF	+105°C, Screw Terminal Type, Long Life Assurance (螺釘型, 長壽命)	Silver (銀)	Black (黑)	-40(-25) ~ +105	10 ~ 500	330 ~ 390000	5,000 Hrs.	P.164
WH	+85°C, Screw Terminal Type, Longer Life Assurance (螺釘型, 較長壽命)	Silver (銀)	Black (黑)	-25 ~ +85	350 ~ 500	470 ~ 22000	10,000 Hrs.	P.169
WL	+85°C, Screw Terminal Type, Ultra Long Life Assurance (螺釘型, 超長壽命)	Silver (銀)	Black (黑)	-25 ~ +85	350 ~ 450	2200 ~ 12000	20,000 Hrs.	P.172
WB	+125°C, Screw Terminal Type, High Temperature (螺釘型, 高溫度)	Silver (銀)	Black (黑)	-25 ~ +125	160 ~ 400	330 ~ 15000	3,000 Hrs.	P.175
V-Chip Aluminum Electrolytic Capacitors								貼片式鋁電解電容器
Surface Mount Type								貼片品
VS1	+85°C, Surface Mount Type, General Purpose (貼片普通品)			-40 ~ +85	6.3 ~ 50	0.1 ~ 1500	2,000 Hrs.	P.179
VT1	+105°C, Surface Mount Type, General Purpose, 1,000 Hours (貼片普通品)			-55 ~ +105	6.3 ~ 50	0.1 ~ 220	1,000 Hrs.	P.181
VTD	+105°C, Surface Mount Type, General Purpose, 2,000 Hours (貼片普通品)			-55 ~ +105	25 ~ 100	4.7 ~ 1500	2,000 Hrs.	P.183
VTG	+105°C, Surface Mount Type, High Voltage, 3,000 Hours (高壓貼片品)			-25 ~ +105	400	2.2 ~ 4.7	3,000 Hrs.	P.185
VZ2	+105°C, Surface Mount Type, Low Impedance (低阻抗貼片品)			-55 ~ +105	6.3 ~ 100	1 ~ 1500	2,000 Hrs.	P.187
VTL	+105°C, Surface Mount Type, Long Life, 3,000/5,000 Hours (長壽命貼片品)			-40 ~ +105	10 ~ 50	0.1 ~ 1000	3,000/5,000Hrs.	P.189



Application Guidelines (應用指引)

1. Circuit Design

- 1.1 Please make sure the environment and mounting conditions to which the capacitor will be exposed are within the conditions specified in this catalog (or alternate SAMXON'S specifications, such as series drawings).
- 1.2 Operating temperature and applied ripple current must be within SAMXON'S specification.
 - The capacitor must not be used in an ambient temperature which exceeds the operating temperature specified in this catalog.
 - Do not apply excessive current which exceeds the allowable ripple current.
- 1.3 Appropriate capacitors which comply with the life requirement of the products should be selected when designing the circuit.
- 1.4 Aluminum electrolytic capacitors are polarized. Do not apply reverse voltage or AC voltage. Please use non-polar capacitors for a circuit that can possibly see reversed polarity. Note: Even non-polar capacitors cannot be used for AC voltage application.
- 1.5 Do not use aluminum electrolytic capacitors in a circuit that requires rapid and very frequent charge/discharge. In this type of circuit, it is necessary to use a special design capacitor with extended life characteristics.
- 1.6 Do not apply excess voltage.
 - Please pay attention so that the peak voltage, which is DC voltage overlapped by ripple current, will not exceed the rated voltage.
 - In the case where more than 2 aluminum electrolytic capacitors are used in series , please make sure that applied voltage will be lower than rated voltage and the voltage will be applied to each capacitor equally using a balancing resistor in parallel with the capacitor.
- 1.7 Outer sleeve of the capacitor is not guaranteed as an electrical insulator.
 - Do not use a standard sleeve on a capacitor in applications that require the electrical insulation. When the application requires special insulation, please contact our sales office for details.
 - Do not connect the blank terminal (reinforcing terminal) of a multi-terminal (three- or four-terminal) product of the snap-in type to another circuit it may cause a short circuit.
- 1.8 Capacitors must not be used under the following conditions:
 - Capacitors must not be exposed to water (including condensation), brine or oil.
 - Ambient conditions that include toxic gases such as hydrogen sulfide, sulfurous acid, nitrous acid, chlorine, ammonium, etc.
 - Ambient conditions that expose the capacitor to ozone, ultraviolet ray and radiation.
 - Severe vibration and physical shock conditions that exceed SAMXON'S specifications.
- 1.9 When designing a circuit board, please pay attention to following:
 - Make the hole spacing on the P.C. board match the lead spacing of the capacitor.
 - There should not be any circuit pattern or circuit wire above the capacitor safety vent.
 - Unless otherwise specified, following clearance should be mad above the safely vent.

Case Diameter	Gap Required
Φ6.3~16	2mm or more
Φ18~35	3mm or more
Φ40 or more	5mm or more

- In case the vent side is placed toward P.C. board (such as end seal vented parts), make a corresponding hole on the P.C. board to release the gas when vent is operated. The hole should be made to match the capacitor vent position.
- Do not install screw terminal capacitor with end seal side down. When you install a screw terminal capacitor in a horizontal mount, the positive terminal must be in the upper position.

- 1.10 The main chemical solution of the electrolyte and the separator paper used in the capacitors are combustible. The electrolyte is conductive. When it comes in contact with the P.C. board, there is a possibility of pattern corrosion or short circuit between the circuit pattern which could in result of smoking or catching fire. Do not locate any circuit pattern beneath the capacitor end seal.
- 1.11 Do not design a circuit board so that heat generating components such as resistor and transistors are placed near an aluminum capacitor or reverse side of P.C. board (under the capacitor).
- 1.12 Electrical characteristics may vary depending on changes in temperature and frequency. Please consider this variation when you design circuits.
- 1.13 When you are designing capacitors for use on double-sided P.C. boards, do not place capacitors on circuit patterns or over the unused holes.
- 1.14 The torque for terminal screw or brackets screws must be within the specified value on SAMXON's drawings.
- 1.15 When you install more than 2 capacitors in parallel, consider the balance of current flowing into the capacitors.

2. Mounting

- 2.1 Once a capacitor has been assembled in the set and power applied, do not attempt to reuse the capacitor in other circuits or application.
- 2.2 Electric potential between positive and negative terminal may exist as a result or returned electromotive force, so please discharge the capacitor using a 1k Ω resistor.
- 2.3 Leakage current of the parts that have been stored for more than 6 months may increase. When leakage current has increased, please perform a voltage treatment using 1k Ω resistor.
- 2.4 Please confirm ratings before installing capacitors on the P.C. board.
- 2.5 Please confirm polarity before installing capacitors on the P.C. board.
- 2.6 Do not drop capacitors on the floor, nor use a capacitor that was dropped.
- 2.7 Be careful not to deform the capacitor during installation.
- 2.8 Please confirm that the lead spacing of the capacitor matches the hole spacing of the P.C. board prior to installation.
- 2.9 Snap-in can type capacitor such as JIS configuration 692, 693, 694 and 695 type should be installed tightly to the P.C. board (allow no gap between the P.C. board and bottom of the capacitor).
- 2.10 Please pay attention that the clinch force is not too strong when capacitors are placed and fixed by an automatic insertion machine.



Application Guidelines (應用指引)

- 2.11 Please pay attention to that the mechanical shock to the capacitor by suction nozzle of the automatic insertion machine or automatic mounter, or by product checker, or by centering mechanism.
- 2.12 Soldering condition must be confirmed to be within SAMXON'S specification.
- Pb/Sn Type
Flow Soldering: $235 \pm 5^{\circ}\text{C}$ ≤ 10 sec.
Hand Soldering (Soldering iron tip): $350 \pm 10^{\circ}\text{C}$ ≤ 3 sec.
 - Pb-free Type
Flow Soldering: $260 \pm 5^{\circ}\text{C}$ ≤ 10 sec.
Hand Soldering (Soldering iron tip): $400 \pm 10^{\circ}\text{C}$ ≤ 3 sec.
- 2.13 Do not tilt lay down or twist the capacitor body after the capacitor are soldered to the P.C. board.
- 2.14 Do not carry the P.C. board by grasping the soldered capacitor.
- 2.15 Please do not allow anything to touch the capacitor after soldering. If P.C. board are stored in stack, please make sure P.C. board or the other components do not touch the capacitor. The capacitors shall not be effected by any radiated heat from the soldered P.C. board or other components after soldering.
- 2.16 Do not clean capacitors with halogenated cleaning agent.
- 2.17 Precautions on fixing materials and coating materials.
- Do not use any ingredients which contain halogen.
 - Please pay attention to remove flux and any contamination which remains in the gap between the end seal and P.C. board and dry that portion well before coating.
 - Please do not apply any material all around the capacitor body but apply it partially.
 - Please contact our sales office to make sure whether the curing condition of coating material would cause any problems.
- 2.18 Do not install screw terminal capacitor with end seal side down. When you install a screw terminal capacitor in a horizontal position, the positive terminal must be in the upper position.

3. Storage

- 3.1 The characteristics of aluminum electrolytic capacitors degrade when stored in a static condition for long period of time. The rate of deterioration depends upon temperature and humidity.
- 3.2 Capacitors should be stored at the temperature of 5°C to 35°C , the humidity of less than 75% RH and out of direct sunlight.
- 3.3 Capacitors that have been stored for long periods normally over one year should be subjected to a "voltage aging" treatment before use. This will reform and repair the oxide dielectric.
- 3.4 Suggested aging procedure is gradually applying the rated voltage to the capacitor(s) for 30 to 60 minutes. If the capacitance still exceeds the specified leakage current value, please do not use it.

4. Disposal

- 4.1 Dispose of capacitors as industrial waste.
- 4.2 Consignment to the waste disposal specialists to handle it professionally.

The above mentioned material according to EIAJ RCR-2367B (issued in March, 2002), titled "Guideline of notabilia for aluminum electrolytic capacitors for use in electronic equipment". Please refer to the book for details.

5. Printed Circuit Board Cleaning

5.1 Foreword

It had been generally accepted that halogen type organic solvents were hazardous to aluminum electrolytic capacitors. This is because an organic solvent can permeate the capacitor through the end seal. Then, the solvent dissolves and free chlorine ion (Cl⁻ion), which can corrode the aluminum electrodes. The following measures were previously the only way to avoid this phenomenon.

- Use of cleaning agents, not hazardous to capacitors such as water or alcohol.
- Mount capacitors on PC boards cleaned with a halogen type solvent beforehand.
- Use of epoxy end seals

These measures have disadvantages with respect to working efficiency, cleaning capability, cost etc. Therefore, aluminum electrolytic capacitors which can withstand halogen type cleaning agents are desirable.

5.2 Types of Cleaning Agents

Generally there are three types of cleaning agents.

- Water type
- Alcohol type
- Halogen type

Of these, water and alcohol will have little effect even if they permeate the capacitor. However, halogens can cause corrosion of aluminum foil and tab. Common types of halogen cleaning agents are listed in Table below:

Chemical Name	Structural Formula	Representative Brand Name
Trichlorotrifluoroethane	C ₂ Cl ₃ F ₃	Freon TF, Daiflon S-3
Fluorotrichloromethane	CCl ₃ F	Freon-11, Daiflon S-1
Trichloroethane	C ₂ H ₃ Cl ₃	Chloroethene
Trichloroethylene	C ₂ HCl ₃	Trichlene
Methyl Chloride	CH ₃ Cl	MC

The last four solvents listed above are particularly corrosive to aluminum and are not recommended to use as cleaning solvents.

5.3 Penetration Channel of Solvent and Corrosion Mechanism

The three channels by which solvents can penetrate into the capacitor are illustrated:

- ① Penetration through a clearance between the rubber and the aluminum case (curled section)
- ② Penetration through a clearance between the rubber and the lead wires
- ③ Permeation through the rubber end seal



To reduce the possibility of solvents entering a capacitor, tight sealing is required to eliminate clearances between the rubber and the aluminum case/lead wires. A solvent resistant rubber material is also a necessity.

When a solvent, for example, trichlorotrifluoroethane gets inside a non anti-solvent capacitor, the chlorine ion is free as shown by the following reaction formula.



This chlorine ion reacts with aluminum as follows:



Then AlCl₃ resolves in water, and it becomes:



Thus, the Cl⁻ion is free again and repeats the corrosion of aluminum. The degree of this reaction depends on the volume of solvent, the ambient temperature of the capacitor in service, the applied voltage and time etc.

Application Guidelines (應用指引)

6. Basic Electrical Characteristics Capacitance:

The capacitance of capacitor is determined as AC capacitance by measuring its impedance. As the AC capacitance depends on frequency, voltage and other measuring methods, JIS C 5102 prescribes that the series capacitive component of an equivalent series circuit (○—R—L—C—○) shall be considered as the capacitance by measuring it at a frequency of 120Hz and a maximum AC voltage of 0.5Vrms with a DC bias voltage of 1.5 to 2.0V applied for aluminum electrolytic capacitors.

The capacitance of an aluminum electrolytic capacitor shows smaller values as a measuring frequency increases. See the typical behavior shown as right chart.



Measuring temperature as well as frequency effects the capacitance. As the measuring temperature decreases, the capacitance shows smaller values. See the typical behavior shown as right chart.



On one hand, DC capacitance, which can be determined by measuring the charge when a DC voltage is applied, shows a slightly larger value than the AC capacitance at a normal temperature and has the flatter characteristic over the temperature range.

Tan δ (tangent of loss angle or dissipation factor):

The tan δ is the ratio of the resistive component (ESR) to the capacitive reactance (1/ωC) in the equivalent series circuit, and its measuring conditions are the same as the capacitance.



The tan δ show higher values as a measuring frequency increases and a measuring temperature decreases, as follows:



Equivalent Series Resistance (ESR)

The ESR is comprised of the resistance due to aluminum oxide layer and electrolyte/separator combination and other resistance effected with foil length, foil surface area, etc.

The ESR value depends on the temperature. Decreasing the temperature makes the resistivity of the electrolyte increase with the result of the ESR increasing.

As the measuring frequency increases, the ESR decreases and reaches an almost constant value that is mainly the frequency-independent resistance due to electrolyte/separator combination.

Impedance (Z):

The impedance is the resistance which oppose the flow of alternating current at a specific frequency. It is related to capacitance (C) and inductance (L) in terms of capacitive and inductive reactance, and also related to the ESR. It is expressed as follows:

$$Z = \sqrt{ESR^2 + (X_L - X_C)^2}$$

Where: $X_C = 1/\omega C = 1/2\pi f C$
 $X_L = \omega L = 2\pi f L$

As shown as right chart, the capacitive reactance (Xc) predominates at the range of low frequencies, and the impedance decreases with increasing frequency until it reaches the ESR in the middle frequency range. At the range of the higher frequencies the inductive reactance (Xl) comes to predominate, so that the impedance increases with increasing the measuring frequency.

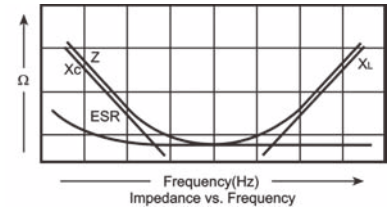

As shown as right chart, the impedance value varies with temperature, because the resistance of the electrolyte strongly changes with temperature.



Leakage Current:

The dielectric of a capacitor has a very high resistance which prevents the flow of DC current. However, due to the characteristics of the aluminum oxide layer that functions as a dielectric in contact with electrolyte, a small amount of current, called leakage current, will flow to reform and repair the oxide layer while a voltage is being applied. As shown below, a high leakage current flows in the first minutes as a voltage is applied to the capacitor, and then the leakage current will decrease and reach an almost steady-state value with time.



Measuring temperature and voltage effect the leakage current. The leakage current shows higher values as the temperature and voltage increase.



In general, the leakage current is measured at 20°C by applying the rated voltage, which is applied through a resistor of 1,000Ω connected in series with the capacitor, and several minutes after the capacitor reached the rated voltage. The catalog prescribes the measuring temperature and time.

LIFE ESTIMATION CHART

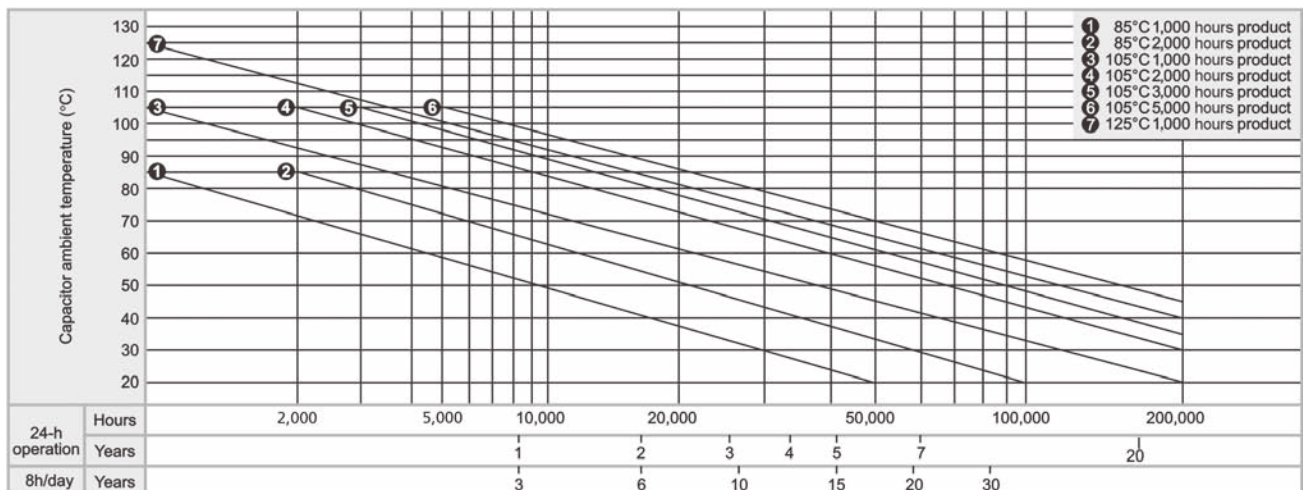



Application Guidelines (應用指引)

7. Quality Policy

7.1 General

Our basic corporate goals and commitment to total quality are set down in our quality policy. The quality of our products and services is an essential part of our corporate strategy, whose paramount aim is total customer satisfaction. Consistent application of quality management system results in flawless products and a high level of user benefit from our components. Our quality management system always reflects the most stringent international standards.

Our corporate goals is to play a leading role among the world's most competitive companies in electronic components. All quality management measures are geared to optimum customer benefit.

They include:

- Mastery of processes
- Continuous improvement programs to narrow process tolerances, and to increase quality and yield.
- Enhanced productivity
- Continuous optimization of material, capital and human resources.
- Promotion of innovation
- Putting customer benefit first in every product we design. Determining customer needs in partnership with customers, and rapid implementation of agreements.

The SAMXON quality management system, which is documented in the new edition of the company-wide SAMXON Quality Management Handbook, is designed to support this strategy.

7.2 Quality assurance

The required measures and regulations for quality assurance are documented in instructions on operations and procedures; the effectiveness and adequacy of the QA system are regularly checked in internal audits.

7.3 Quality programs

Project-oriented improvement programs pursuing the strategic objective of zero defects are set up and conducted by specialist teams.

7.4 Process assurance

Assurance of production processes starts as early as the planning and development phase. Quality tools like FMEA and SVP help detect and avoid potential errors, and safeguard process capability and product quality. Documentation of all production and testing steps as well as training of personnel are essential to flawless production. Statistical process control (SPC) is used wherever applicable. Permanent availability of plant is ensured by preventive maintenance.

7.5 Incoming inspection

Raw materials, parts and consumable undergo incoming inspection appropriate to their significance in the end product, unless this responsibility has been transferred to the supplier under a quality assurance agreement or similar.

7.6 In-process inspection

Wherever possible, in-process inspection is conducted to certify the conformity not only of intermediate products, but also of process supervision and control (e.g. SPC). It is generally integrated into the process steps and designed to be as preventive as possible, i.e. to avoid errors.

7.7 Final inspection/approval for shipment

Final inspection verifies the major properties of the end products batch by batch, usually by means of fully automated selection tests.

Approval for shipment helps certify that products shipped comply with specifications. It includes:

- Testing of principal parameter,
- Identification check and visual assessment,
- Examination of papers accompanying the batch.

8. Manufacturing and quality assurance procedures for Al electrolytic capacitors





Application Guidelines (應用指引)

9. Environmental

Environmental policy

Our fundamental commitment to protection of the environment is laid down in SAMXON environmental policy:

- We work continuously to lighten the burden on the environment and to reduce consumption of energy and resources beyond statutory requirements.
- We take all precautions to avoid environmental hazards and to prevent damage to the environment.
- Potential impact on the environment is assessed and flows into product and process planning at the earliest possible stage.
- Our environmental management system ensures that our environmental policy is effectively implemented. The technical and organizational procedures required are regularly monitored and constantly upgraded.
- Every employee is required to act in an environmentally conscious manner. It is a permanent task of management to promote awareness of responsibility for the environment at all levels.
- We seek to influence our business associates to follow environmental guidelines similar to ours. We supply our customers with information on environmentally friendly use of our products. We work in a spirit of cooperation with the authorities.
- We inform the public of the environmental impact of our activities and the environmental achievements of our company.

10. Compliance with RoHS Directive

The company is committed to compliance with the European Union Restriction of Hazardous Substance (RoHS) Directive. We hereby guarantee that our products do not contain following materials exceeding the RoHS Directive (2011/65/EU).

- | | |
|---|----------|
| ■ Lead (Pb) and its compounds | ≤1000ppm |
| ■ Mercury (Hg) and its compounds | ≤1000ppm |
| ■ Cadmium (Cd) and its compounds | ≤100ppm |
| ■ Hexavalent chromium, Cr ⁶⁺ , Cr VI | ≤1000ppm |
| ■ Polybrominated biphenyls, PBBs | ≤1000ppm |
| ■ Polybrominated diphenyls, PBDEs | ≤1000ppm |

11. Halogen Free Compliant

The products identified in the catalogue, and their homogeneous subcomponents, do not contain any of the following substances in concentrations greater than the listed maximum limits.

Substance	Maximum Limit (ppm)
Bromine (Br)	900 ppm (0.09%)
Chlorine (Cl)	900 ppm (0.09%)
Total concentration of Chlorine (Cl) + Bromine (Br)	1500 ppm (0.15%)

Part Number System (產品編碼)

1 2 3			4 5 6			7	8 9		10 11 12			13 14		15 16		17	
EGS			105			M	1H		D11			TC		SA		P	
SERIES			CAPACITANCE			TOLERANCE		VOLTAGE		CASE SIZE			TYPE		SAMXON PRODUCT LINE		SLEEVE MATERIAL
Series	Cap (uF)	Code	Tol. (%)	Code	Vol. (W.V)	Code	Case Size		Feature	Code	SAMXON Product Line		Sleeve Material	Code			
EKF	0.1	104	±5	J	2	0D	Diameter(φ)		Radial bulk	RR	For internal use only (The product lines we have H,A,B,C,D,E,M or 0,1,2,3,4,5,9).		PET	P			
EKS					2.5	0E	3	B									
EGS					4	0G	3.5	1									
EKM	0.22	224	±10	K	6.3	0J	Code		Ammo Taping		If the sleeve material is PVC, there will be blank in seventeenth digit.		PVC				
EKG					8	0K	5	D									
EOM					10	1A	6.3	E									
EGF	0.33	334	±15	L	12.5	1B	Len. (mm)		2.0mm Pitch	TT	If the sleeve material is PVC, there will be blank in seventeenth digit.		PVC				
ESF					16	1C	4.5	45									
EGT					20	1D	5	05									
EGK	0.47	474	±20	M	25	1E	Code		2.5mm Pitch	TU	If the sleeve material is PVC, there will be blank in seventeenth digit.		PVC				
ESK					30	1I	5.4	54									
ESH					32	13	7	07									
ESK	2.2	225	-20	0	35	1V	Code		3.5mm Pitch	TV	If the sleeve material is PVC, there will be blank in seventeenth digit.		PVC				
ERS					40	1G	7.7	77									
EGY					42	1M	11	11									
ERF	3.3	335	-20	+10	50	1H	Code		5.0mm Pitch	TC	If the sleeve material is PVC, there will be blank in seventeenth digit.		PVC				
ERR					57	1L	11.5	11A									
ERT					63	1J	12	12									
ERE	4.7	475	-20	+40	71	1S	Code		Lead Cut & Form		If the sleeve material is PVC, there will be blank in seventeenth digit.		PVC				
ERD					75	1T	12.5	12									
ERH					80	1K	13	13									
EBD	22	226	-20	+50	85	1R	Code		CB-Type	CB	If the sleeve material is PVC, there will be blank in seventeenth digit.		PVC				
ERA					90	19	13.5	13									
ERB					90	19	13.5	13									
ERC	33	336	-10	0	90	19	Code		CE-Type	CE	If the sleeve material is PVC, there will be blank in seventeenth digit.		PVC				
EFA					100	2A	13.5	13									
ENP					120	2O	13.5	13									
ENH	47	476	-10	+20	125	2B	Code		HE-Type	HE	If the sleeve material is PVC, there will be blank in seventeenth digit.		PVC				
ERW					150	2Z	13.5	13									
ERY					160	2C	13.5	13									
ELP	220	227	-10	+50	180	2P	Code		KD-Type	KD	If the sleeve material is PVC, there will be blank in seventeenth digit.		PVC				
EAP					200	2D	13.5	13									
EQP					215	22	13.5	13									
EDP	330	337	+13	+50	215	22	Code		FD-Type	FD	If the sleeve material is PVC, there will be blank in seventeenth digit.		PVC				
ETP					220	2N	13.5	13									
EHP					230	23	13.5	13									
EUP	470	477	-5	+15	250	2E	Code		EH-Type	EH	If the sleeve material is PVC, there will be blank in seventeenth digit.		PVC				
EKP					275	2T	13.5	13									
EPK					300	2I	13.5	13									
EEP	22000	229	-5	+20	310	2R	Code		PCB Terminal		If the sleeve material is PVC, there will be blank in seventeenth digit.		PVC				
EFP					315	2F	13.5	13									
ESP					330	2U	13.5	13									
EVP	33000	339	0	+20	330	2U	Code		Snap-in	SW	If the sleeve material is PVC, there will be blank in seventeenth digit.		PVC				
EGP					350	2V	13.5	13									
EWR					350	2V	13.5	13									
EWI	47000	479	0	+30	360	2X	Code		Snap-in	SX	If the sleeve material is PVC, there will be blank in seventeenth digit.		PVC				
EWT					375	2Y	13.5	13									
EWX					400	2G	13.5	13									
EWX	100000	10T	0	+50	420	2M	Code		Snap-in	SZ	If the sleeve material is PVC, there will be blank in seventeenth digit.		PVC				
EWX					420	2M	13.5	13									
EWX					450	2W	13.5	13									
EWX	150000	15T	+5	+15	450	2W	Code		Lug	SG	If the sleeve material is PVC, there will be blank in seventeenth digit.		PVC				
EWX					500	2H	13.5	13									
EWX					550	25	13.5	13									
EWX	220000	22T	+5	+20	600	26	Code		Lug	SG	If the sleeve material is PVC, there will be blank in seventeenth digit.		PVC				
EWX					600	26	13.5	13									
EWX					630	2J	13.5	13									
EWX	330000	33T	+10	+50	630	2J	Code		Screw	O5	If the sleeve material is PVC, there will be blank in seventeenth digit.		PVC				
EWX					630	2J	13.5	13									
EWX					630	2J	13.5	13									
EWX	1000000	10M	+10	+50	630	2J	Code		Screw	O6	If the sleeve material is PVC, there will be blank in seventeenth digit.		PVC				
EWX					630	2J	13.5	13									
EWX					630	2J	13.5	13									
EWX	1500000	15M	+10	+50	630	2J	Code		Screw	O5	If the sleeve material is PVC, there will be blank in seventeenth digit.		PVC				
EWX					630	2J	13.5	13									
EWX					630	2J	13.5	13									
EWX	2200000	22M	+10	+50	630	2J	Code		Screw	O6	If the sleeve material is PVC, there will be blank in seventeenth digit.		PVC				
EWX					630	2J	13.5	13									
EWX					630	2J	13.5	13									
EWX	3300000	33M	+10	+50	630	2J	Code		Screw	O6	If the sleeve material is PVC, there will be blank in seventeenth digit.		PVC				
EWX					630	2J	13.5	13									
EWX					630	2J	13.5	13									

Taping Specifications (編帶產品規格)



Fig-1



Fig-2



Fig-3

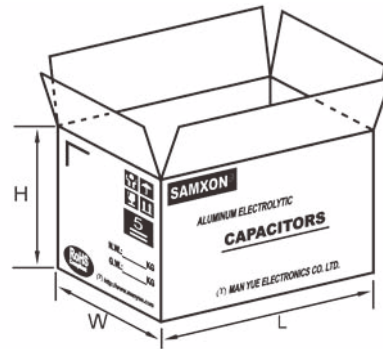

Fig-4

SPECIFICATIONS

Item	Reference figure	Dimensions (mm)												Tol.	
		Fig 1			Fig 2			Fig 3		Fig 4					
Diameter	D	3	4 ~ 5	5	6.3	8	10	12.5	16, 18	4, 5, 6.3	5, 6.3	8			
Height	A	5	5 ~ 7	9 ~ 15	5 ~ 7	9 ~ 15	11 ~ 20	9 ~ 21	15 ~ 35	15 ~ 40	5 ~ 7	9 ~ 15	5 ~ 9	11 ~ 20	
Lead Diameter	d	0.4	0.45	0.5	0.45	0.5	0.5	0.6	0.6	0.8	0.45	0.5	0.45	0.5	±0.05
Component Spacing	P	12.7			12.7	12.7	12.7	12.7	15	30	12.7		12.7	12.7	±1.0
Pitch of sprocket holes	P ₀	12.7			12.7	12.7	12.7	12.7	15	15	12.7		12.7	12.7	±0.2
Distance between centres of component leads	F	2.5			2.5	3.5	5.0	5.0	7.5	7.5	5.0		5.0	5.0	±0.05
Carrier tape width	W	18.0			18.0	18.0	18.0	18.0	18.0	18.0	18.0		18.0	18.0	±0.5
Distance between the center of upper edge of carrier tape and sprocket holes	W ₁	9.0			9.0	9.0	9.0	9.0	9.0	9.0	9.0		9.0	9.0	±0.5
Distance between the abscissa and the bottom of the components body	H	18.5			18.5	18.5	18.5	18.5	18.5	18.5	17.5	18.5	17.5	20.0	±0.75
Distance between the abscissa and the reference plane of the components with crimped leads	H ₀	-			-	-	-	-	-	-	16.0		16.0	16.0	±0.5
Hold down tape width	W ₀	7.0			7.0	7.0	7.0	7.0	12	12	7.0		7.0	7.0	Min.
Max. lateral deviation of the component body vertical to the tape plane	Δh	0			0	0	0	0	0	0	0		0	0	±1.0
Distance between the upper edges of the carrier tape and the hold down tape	W ₂	0 ~ 3			0 ~ 3	0 ~ 3	0 ~ 3	0 ~ 3	0 ~ 3	0 ~ 3	0 ~ 3		0 ~ 3	0 ~ 3	-
Distance between center of terminal and the sprocket holes	P ₁	5.1			5.1	4.6	3.85	3.85	5.0	3.75	3.85		3.85	3.85	±0.5
Distance between center of the component and sprocket holes	P ₂	6.35			6.35	6.35	6.35	6.35	7.5	7.5	6.35		6.35	6.35	±1.0

Packing Specifications (包裝規格)



PACKING QUANTITY (TAPING TYPE)

ΦD x L (mm)	L (mm)	W (mm)	H (mm)	Inner Box Quantity	Outer Box Quantity
3 x 5	330	229	51	3,000	30,000
4 x 5 ~ 7	330	229	51	2,500	25,000
5 x 5 ~ 11	330	229	51	2,000	20,000
6.3 x 5 ~ 12	330	229	51	1,500	15,000
8 x 5 ~ 12	330	229	51	1,000	10,000
8 x 14 ~ 20	330	229	64	1,000	8,000
10 x 12.5	330	191	51	500	5,000
10 x 16	330	191	56	500	5,000
10 x 20 ~ 25	323	191	64	500	4,000
10 x 30	330	191	69	500	4,000
12.5 x 20	325	267	58	500	2,000
12.5 x 25	325	270	63	500	2,000
12.5 x 35	325	270	74	500	2,000
16 x 25	315	221	63	250	1,000
16 x 30 ~ 35	315	221	76	250	1,500
18 x 20 ~ 25	343	275	63	250	1,000
18 x 30 ~ 35	343	275	73	250	500
18 x 40	343	275	73	250	500

PACKING QUANTITY (BULK TYPE)

Long Lead Wire Product					
ΦD x L (mm)	Plastic Bag Quantity	Inner Box Quantity	Outer Box Quantity	Inner Box Quantity	Outer Box Quantity
3 x 5	1,000	24,000	96,000		
4 x 5	1,000	16,000	64,000		
4 x 7	1,000	14,000	56,000		
5 x 5	1,000	12,000	48,000		
5 x 7	1,000	10,000	40,000		
5 x 11	1,000	8,000	32,000		
6.3 x 5 ~ 7	1,000	8,000	32,000		
6.3 x 11	1,000	6,000	24,000		
8 x 5 ~ 7	1,000	6,000	24,000		
8 x 9	500	4,000	16,000		
8 x 10 ~ 16	500	3,000	12,000		
8 x 20	200	1,600	6,400		
8 x 25	200	1,200	4,800		
10 x 12.5	400	2,400	9,600		
10 x 15 ~ 20	200	1,200	7,200		
10 x 25 ~ 30	200	1,200	4,800		
12.5 x 20	150	1,200	4,800		
12.5 x 25	150	900	3,600		
12.5 x 30 ~ 35	100	600	2,400		
12.5 x 40	-	300	1,800		
16 x 20	-	200	2,000		
16 x 25 ~ 30	-	200	1,600		
16 x 35 ~ 40	-	200	1,200		
18 x 15 ~ 20	-	150	1,500		
18 x 25 ~ 30	-	150	1,200		
18 x 35 ~ 50	-	150	900		

PACKING QUANTITY (SNAP-IN)

Snap-in Terminal Product					
ΦD x L (mm)	Inner Box Quantity	Outer Box Quantity	ΦD x L (mm)	Inner Box Quantity	Outer Box Quantity
20 x 25	100	1,200	25 x 30 ~ 35	100	800
20 x 30 ~ 40	100	1,000	25 x 40 ~ 50	100	600
22 x 25	100	1,200	30 x 30 ~ 35	50	500
22 x 30 ~ 40	100	1,000	30 x 40 ~ 50	50	400
22 x 45 ~ 50	100	800	35 x 30 ~ 35	40	400
25 x 25	100	1,000	35 x 40 ~ 50	40	320

Lead Forming Specifications (成型產品規格)



TYPE CB



TYPE KD

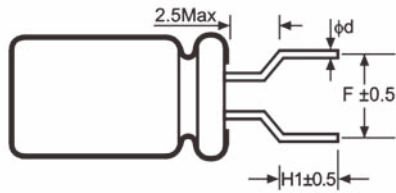

TYPE HE

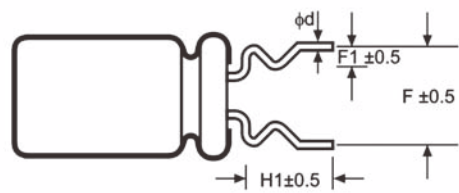

TYPE EC



TYPE FD



TYPE PC

SHAPE CODE	ϕD	4	5	6.3	8 (L > 5mm)	10	13	16	18
CB	F	1.5	2.0	2.5	3.5	5.0	5.0	7.5	7.5
	H	3.5	3.5	3.5	3.5	3.5	3.5	3.5	3.5
	$\phi d \pm 0.05$	0.45	0.5	0.5	0.5	0.6	0.6	0.8	0.8
HE	F	5.0	5.0	5.0	5.0	-	-	-	-
	H1	5.0	5.0	5.0	5.0	-	-	-	-
	$\phi d \pm 0.05$	0.45	0.5	0.5	0.5	-	-	-	-
FD	F	5.0	5.0	5.0	5.0	-	-	-	-
	H1	4.5	4.5	4.5	4.5	-	-	-	-
	H2	1.8	1.8	1.8	1.8	-	-	-	-
	$\phi d \pm 0.05$	0.45	0.5	0.5	0.5	-	-	-	-
KD	E	1.12	1.12	1.12	1.30	-	-	-	-
	F	-	-	-	-	5.0	5.0	7.5	7.5
	H1	-	-	-	-	4.5	4.5	4.5	4.5
	H2	-	-	-	-	2.0	2.0	2.0	2.0
	$\phi d \pm 0.05$	-	-	-	-	0.6	0.6	0.8	0.8
EC	E	-	-	-	-	1.30	1.30	1.30	1.30
	F	5.0	5.0	5.0	5.0	-	-	-	-
	F1	1.2	1.2	1.2	1.2	-	-	-	-
	H1	4.0	4.0	4.0	4.0	-	-	-	-
PC	$\phi d \pm 0.05$	0.45	0.5	0.5	0.5	-	-	-	-
	F	-	2.0	2.5	3.5	5.0	5.0	7.5	7.5
	H	-	4.0	4.0	4.0	4.0	4.0	4.0	4.0
	H1	-	3.0	3.0	3.0	3.0	3.0	3.0	3.0
	$\phi d \pm 0.05$	-	0.5	0.5	0.5	0.6	0.6	0.8	0.8

FEATURES

- Super miniature, 5mmL, high temperature, suitable for use in electronic circuit of high density assembly of video recorder, remote controller, VCD etc.



SPECIFICATIONS

Item	Performance Characteristics							
Operating Temperature Range	-40 to +105°C							
Rated Working Voltage Range	4 to 50V							
Nominal Capacitance Range	3.3 to 330μF							
Capacitance Tolerance	±20% at 120Hz, +20°C							
Leakage Current	I ≤ 0.01CV or 3 (μA) whichever is greater measured after 2 minutes application of rated working voltage at +20°C							
tan δ (120Hz, +20°C)	Working Voltage (V)	4	6.3	10	16	25	35	50
	tan δ (max.)	0.37	0.28	0.24	0.20	0.16	0.13	0.12
Low Temperature Characteristics	Impedance ratio max. at 120Hz							
	Working Voltage (V)	4	6.3	10	16	25	35	50
	Z-25°C / Z+20°C	6	3	3	2	2	2	2
	Z-40°C / Z+20°C	12	8	5	4	3	3	3
High Temperature Loading	Test time	: 1,000 hours			Post test requirements at +20°C			
	Test temperature	: +105°C			Leakage current : ≤ initial specified value			
	Test conditions	: Rated DC working voltage with rated ripple current			Cap. change : within ±20% of the initial measured value (4V: within ±30%)			
					tan δ : ≤ 200% of the initial specified value			
Shelf Life	At +105°C no voltage applied after 1,000 hours and then being stabilized at +20°C the capacitors shall meet the following limits							
	Leakage current	: ≤ initial specified value						
	Cap. change	: within ±20% of the initial measured value (4V: within ±30%)						
	tan δ	: ≤ 200% of the initial specified value						
Industrial Standard	JIS C - 5101-4 (IEC 60384-4)							

CASE SIZE TABLE



φD	4	5	6.3	8
F	1.5	2.0	2.5	2.5
φd	0.45			

RIPPLE CURRENT MULTIPLIER

Frequency Coefficient

Coefficient	Cap (μF)	50	120	300	1k	10k~
≤47		0.75	1.00	1.35	1.57	2.00
68~330		0.80	1.00	1.23	1.34	1.50

PART NUMBER SYSTEM (EXAMPLE : 16V 33μF)

1	2 3	4 5 6	7	8 9	10	11 12	13 14
E	KF	336	M	1C	E	05	RR



STANDARD RATINGS

Voltage (Code)		4V (0G)		6.3V (0J)		10V (1A)		16V (1C)	
Cap. (μF)	Code	Case Size	Ripple Current	Case Size	Ripple Current	Case Size	Ripple Current	Case Size	Ripple Current
10	106							4 x 5	18
22	226	4 x 5	22	4 x 5	22	4 x 5	24	5 x 5	30
33	336	5 x 5	30	5 x 5	30	5 x 5	35	6.3 x 5	40
47	476	5 x 5	36	5 x 5	36	6.3 x 5	46	6.3 x 5	50
100	107	6.3 x 5	60	6.3 x 5	60	6.3 x 5	67	6.3 x 5	73
220	227			8 x 5	103	8 x 5	116	8 x 5	126
330	337			8 x 5	127				

Maximum Allowable Ripple Current (mArms) at 105°C 120Hz

Case Size ΦD x L (mm)

Voltage (Code)		25V (1E)		35V (1V)		50V (1H)	
Cap. (μF)	Code	Case Size	Ripple Current	Case Size	Ripple Current	Case Size	Ripple Current
3.3	335			4 x 5	11	4 x 5	14
4.7	475	4 x 5	13	4 x 5	15	5 x 5	19
10	106	4 x 5	20	5 x 5	25	6.3 x 5	30
22	226	6.3 x 5	38	6.3 x 5	48	8 x 5	52
33	336	6.3 x 5	48	6.3 x 5	59	8 x 5	63
47	476	6.3 x 5	58	8 x 5	82		
100	107	8 x 5	97				

Maximum Allowable Ripple Current (mArms) at 105°C 120Hz

Case Size ΦD x L (mm)

Specifications are subject to change without notice. Should a safety or technical concern arise regarding the product, please be sure to contact our sales offices or agents immediately.

FEATURES

- Rated working voltage range 6.3 to 50V DC operation temperature range -40 to +105°C.
- This series is for communication equipments, switching power supply, industrial measuring instruments, automotive electric products, etc.



SPECIFICATIONS

Item	Performance Characteristics						
Operating Temperature Range	-40 to +105°C						
Rated Working Voltage Range	6.3 to 50V						
Nominal Capacitance Range	3.3 to 330μF						
Capacitance Tolerance	±20% at 120Hz, +20°C						
Leakage Current	I ≤ 0.01CV or 3 (μA) whichever is greater measured after 2 minutes application of rated working voltage at +20°C						
tan δ (120Hz, +20°C)	Working Voltage (V)	6.3	10	16	25	35	50
	tan δ (max.)	0.24	0.21	0.18	0.15	0.13	0.12
Low Temperature Characteristics	Impedance ratio max. at 120Hz						
	Working Voltage (V)	6.3	10	16	25	35	50
	Z-25°C / Z+20°C	4	2	2	2	2	2
	Z-40°C / Z+20°C	8	5	4	3	3	3
High Temperature Loading	Test time	: 1,000 hours		Post test requirements at +20°C			
	Test temperature	: +105°C		Leakage current : ≤ Initial specified value			
	Test conditions	: Rated DC working voltage with rated ripple current		Cap. change : within ±20% of the initial measured value			
				tan δ : ≤ 200% of the initial specified value			
Shelf Life	At +105°C no voltage applied after 1,000 hours and then being stabilized at +20°C the capacitors shall meet the following limits						
	Leakage current	: ≤ Initial specified value					
	Cap. change	: within ±20% of the initial measured value					
	tan δ	: ≤ 200% of the initial specified value					
Industrial Standard	JIS C - 5101-4 (IEC 60384-4)						

CASE SIZE TABLE



ΦD	4	5	6.3	8
F	1.5	2.0	2.5	3.5
Φd	0.45			
α	(L ≤ 7) 1		(L ≥ 9) 1.5	

RIPPLE CURRENT MULTIPLIER

Frequency Coefficient

Coefficient	Cap (μF)	50	120	300	1k	10k~
≤47		0.75	1.00	1.35	1.57	2.00
68~220		0.80	1.00	1.23	1.34	1.50

PART NUMBER SYSTEM (EXAMPLE : 6.3V 47μF)

1	2 3	4 5 6	7	8 9	10	11 12	13 14
E	KS	476	M	OJ	D	07	RR



STANDARD RATINGS

Voltage (Code)		6.3V (0J)		10V (1A)		16V (1C)		25V (1E)	
Cap. (μF)	Code	Case Size	Ripple Current	Case Size	Ripple Current	Case Size	Ripple Current	Case Size	Ripple Current
10	106					4 x 7	29	4 x 7	29
22	226	4 x 7	34	4 x 7	34	4 x 7	38	5 x 7	45
33	336	4 x 7	37	4 x 7	40	5 x 7	50	5 x 7	55
47	476	4 x 7	44	5 x 7	50	5 x 7	60	6.3 x 7	67
100	107	5 x 7	67	5 x 7	72	6.3 x 7	92	6.3 x 7	97
				6.3 x 7	83	8 x 7	106	8 x 7	113
220	227	6.3 x 7	112	8 x 7	140	8 x 9	174		
330	337	8 x 7	158						

Maximum Allowable Ripple Current (mArms) at 105°C 120Hz

Case Size ΦD x L (mm)

Voltage (Code)		35V (1V)		50V (1H)	
Cap. (μF)	Code	Case Size	Ripple Current	Case Size	Ripple Current
3.3	335			4 x 7	24
4.7	475	4 x 7	24	5 x 7	29
10	106	5 x 7	36	5 x 7	38
				6.3 x 7	44
22	226	6.3 x 7	57	8 x 7	65
33	336	6.3 x 7	62		
47	476	6.3 x 7	74		
100	107	8 x 9	65		

Maximum Allowable Ripple Current (mArms) at 105°C 120Hz

Case Size ΦD x L (mm)

Specifications are subject to change without notice. Should a safety or technical concern arise regarding the product, please be sure to contact our sales offices or agents immediately.

FEATURES

- High CV value, guarantee 2,000 hours load life at 85°C.
- Suitable for use in electronic circuits in colour TV receiver, video recorder etc.



SPECIFICATIONS

Item	Performance Characteristics	
Operating Temperature Range	-40 to +85°C	-25 to +85°C
Rated Working Voltage Range	6.3 to 100V	160 to 450V
Nominal Capacitance Range	2.2 to 22000µF	
Capacitance Tolerance	±20% at 120Hz, +20°C	
Leakage Current	I ≤ 0.01CV or 3 (µA) whichever is greater measured after 2 minutes application of rated working voltage at +20°C	
tan δ (120Hz, +20°C)	Working Voltage (V)	6.3 10 16 25 35 50 63 100
	tan δ (max.)	0.28 0.24 0.20 0.16 0.14 0.12 0.10 0.08
	Working Voltage (V)	160 200 250 350 400 450
	tan δ (max.)	0.20 0.20 0.20 0.25 0.25 0.25
Low Temperature Characteristics	For capacitance value >1000µF, add 0.02 per another 1000µF	
	Impedance ratio max. at 120Hz	
	Working Voltage (V)	6.3 10 16 25 35 50 63 100
	Z-25°C / Z+20°C	5 4 3 2 2 2 2 2
	Z-40°C / Z+20°C	12 10 8 5 4 3 3 3
	Working Voltage (V)	160 200 250 350 400 450
High Temperature Loading	Test time : 2,000 hours	
	Test temperature : +85°C	
	Test conditions : Rated DC working voltage with rated ripple current	
	Post test requirements at +20°C Leakage current : ≤Initial specified value Cap. change : within ±20% of the initial measured value tan δ : ≤200% of the initial specified value	
Shelf Life	At +85°C no voltage applied after 1,000 hours and then being stabilized at +20°C the capacitors shall meet the following limits	
	Leakage current : ≤Initial specified value	
	Cap. change : within ±20% of the initial measured value	
	tan δ : ≤200% of the initial specified value	
Industrial Standard	JIS C - 5101-4 (IEC 60384-4)	

CASE SIZE TABLE



ΦD	8 (L <20)	8 (L ≥20)	10	12.5	16	18	22	25
F	3.5	3.5	5.0	5.0	7.5	7.5	10.0	12.5
Φd	0.5	0.6	0.6	0.6	0.8	0.8	0.8	1.0
α	(L <20) 1.5				(L ≥20) 2.0			
β	(D <20) 0.5				(D ≥20) 1.0			

PART NUMBER SYSTEM (EXAMPLE : 16V 470µF)



STANDARD RATINGS

Voltage (Code)		6.3V (0J)		10V (1A)		16V (1C)		25V (1E)	
Cap. (µF)	Code	Case Size	Ripple Current	Case Size	Ripple Current	Case Size	Ripple Current	Case Size	Ripple Current
220	227							8 x 12	370
330	337							8 x 12	453
470	477					8 x 12	499	10 x 12.5	628
680	687	8 x 12	503	8 x 12	546	10 x 12.5	690	10 x 16	826
1000	108	8 x 12	610	10 x 12.5	791	10 x 16	928	10 x 20	1094
1500	158	10 x 12.5	780	10 x 16	875	10 x 20	1025	12.5 x 20	1210
2200	228	10 x 16	890	10 x 20	1226	12.5 x 20	1555	12.5 x 25	1800
3300	338	10 x 20	1350	12.5 x 20	1685	12.5 x 25	1990	16 x 25	2304
4700	478	12.5 x 20	1822	12.5 x 25	2103	16 x 25	2487	16 x 30	2854
6800	688	12.5 x 25	1930	16 x 25	2606	16 x 30	3010	16 x 40	3528
								18 x 35	3546
10000	109	16 x 25	2760	16 x 30	2960	16 x 35	3490		
15000	159	16 x 35	2860	16 x 40	3100				
22000	229	18 x 40	3400						

Maximum Allowable Ripple Current (mArms) at 85°C 120Hz

Case Size Φ D x L (mm)

Voltage (Code)		35V (1V)		50V (1H)		63V (1J)		100V (2A)	
Cap. (µF)	Code	Case Size	Ripple Current	Case Size	Ripple Current	Case Size	Ripple Current	Case Size	Ripple Current
33	336							8 x 12	187
47	476							10 x 12.5	259
68	686					8 x 12	220	10 x 16	290
100	107			8 x 12	306	8 x 12	321	10 x 20	453
220	227	8 x 12	405	10 x 12.5	506	10 x 16	615	12.5 x 20	742
330	337	10 x 12.5	576	10 x 16	706	10 x 20	823	12.5 x 25	987
470	477	10 x 16	753	10 x 20	811	12.5 x 20	1153	16 x 25	1394
680	687	10 x 20	988	12.5 x 20	988	12.5 x 25	1512	16 x 30	1400
1000	108	12.5 x 20	1407	12.5 x 25	1715	16 x 25	2037	18 x 35	1995
2200	228	16 x 25	2134	16 x 30	2320	18 x 35	2300		
3300	338	16 x 30	2338	18 x 35	3218	18 x 40	2500		
4700	478	18 x 35	3400	18 x 40	3336				
5600	568	18 x 40	3411						
6800	688	18 x 40	3500						

Maximum Allowable Ripple Current (mArms) at 85°C 120Hz

Case Size Φ D x L (mm)

Specifications are subject to change without notice. Should a safety or technical concern arise regarding the product, please be sure to contact our sales offices or agents immediately.

STANDARD RATINGS

Voltage (Code)		160V (2C)		200V (2D)		250V (2E)		350V (2V)	
Cap. (μF)	Code	Case Size	Ripple Current	Case Size	Ripple Current	Case Size	Ripple Current	Case Size	Ripple Current
3.3	335							8 x 12	56
4.7	475							10 x 12.5	77
10	106	8 x 12	82	8 x 12	90	10 x 12.5	113	10 x 16	120
22	226	10 x 16	150	10 x 16	168	10 x 20	185	12.5 x 20	233
33	336	10 x 20	243	10 x 20	245	10 x 20	198	16 x 25	312
47	476	10 x 20	307	12.5 x 20	343	12.5 x 20	235	16 x 25	413
68	686	12.5 x 20	350	12.5 x 25	350	16 x 25	380	16 x 25	450
100	107	12.5 x 25	541	16 x 25	601	16 x 25	572	18 x 35	518
220	227	16 x 30	976	16 x 35	1138				
330	337	18 x 35	1346	18 x 35	1324				

Maximum Allowable Ripple Current (mArms) at 85°C 120Hz

Case Size Φ D x L (mm)

Voltage (Code)		400V (2G)		450V (2W)	
Cap. (μF)	Code	Case Size	Ripple Current	Case Size	Ripple Current
2.2	225	8 x 12	47	8 x 12	40
3.3	335	8 x 12	55	10 x 12.5	54
4.7	475	10 x 12.5	73	10 x 16	72
10	106	10 x 16	120	10 x 20	98
22	226	12.5 x 20	230	12.5 x 25	202
33	336	16 x 25	345	16 x 25	271
47	476	16 x 25	437	16 x 30	355
68	686	16 x 30	500	18 x 35	360
82	826	16 x 30	550	18 x 40	385
100	107	18 x 35	720		

Maximum Allowable Ripple Current (mArms) at 85°C 120Hz

Case Size Φ D x L (mm)

RIPPLE CURRENT MULTIPLIER

Frequency Coefficient

Rated Voltage	Coefficient		Freq. (Hz)				
	Cap. (μF)		50	120	300	1k	10k~
6.3~100V	≤47		0.75	1.00	1.35	1.57	2.00
	68~470		0.80	1.00	1.23	1.34	1.50
	≥560		0.85	1.00	1.10	1.13	1.15
160~450V	2.2~220		0.80	1.00	1.25	1.40	1.60
	≥270		0.90	1.00	1.10	1.13	1.15

Specifications are subject to change without notice. Should a safety or technical concern arise regarding the product, please be sure to contact our sales offices or agents immediately.

FEATURES

- Rated working voltage range 6.3 to 100V DC / 160 to 450V DC at operation temperature range -40 to +105°C / -25 to +105°C.
- This series is for communication equipments, switching power supply, industrial measuring instruments, automotive electric products, etc.



SPECIFICATIONS

Item	Performance Characteristics	
Operating Temperature Range	-40 to +105°C	-25 to +105°C
Rated Working Voltage Range	6.3 to 100V	160 to 450V
Nominal Capacitance Range	0.47 to 33000µF	
Capacitance Tolerance	±20% at 120Hz, +20°C	
Leakage Current	I ≤0.01CV or 3 (µA) whichever is greater measured after 2 minutes application of rated working voltage at +20°C	
tan δ (120Hz, +20°C)	Working Voltage (V)	6.3 10 16 25 35 50 63 100
	tan δ (max.)	0.26 0.22 0.18 0.16 0.14 0.12 0.10 0.08
	Working Voltage (V)	160 200 220 250 350 400 420 450
	tan δ (max.)	0.20 0.20 0.20 0.20 0.24 0.24 0.24 0.24
For capacitance value >1000µF, add 0.02 per another 1000µF		
Low Temperature Characteristics	Impedance ratio max. at 120Hz	
	Working Voltage (V)	6.3 10 16 25 35 50 63 100
	Z-25°C / Z+20°C	5 4 3 2 2 2 2 2
	Z-40°C / Z+20°C	10 8 6 4 3 3 3 3
Working Voltage (V)	160 200 220 250 350 400 420 450	
Z-25°C / Z+20°C	3 3 3 4 4 6 6 15	
For capacitance value >1000µF, add 0.5 per another 1000µF for Z-25°C / Z+20°C add 1.0 per another 1000µF for Z-40°C / Z+20°C		
High Temperature Loading	Test time	: 2,000 hours
	Test temperature	: +105°C
	Test conditions	: Rated DC working voltage with rated ripple current.
	Post test requirements at +20°C	Leakage current : ≤Initial specified value Cap. change : within ±20% of the initial measured value tan δ : ≤200% of the initial specified value
Shelf Life	At +105°C no voltage applied after 1,000 hours and then being stabilized at +20°C the capacitors shall meet the following limits	
	Leakage current	: ≤Initial specified value
	Cap. change	: within ±20% of the initial measured value
	tan δ	: ≤200% of the initial specified value
Industrial Standard	JIS C - 5101-4 (IEC 60384-4)	

CASE SIZE TABLE

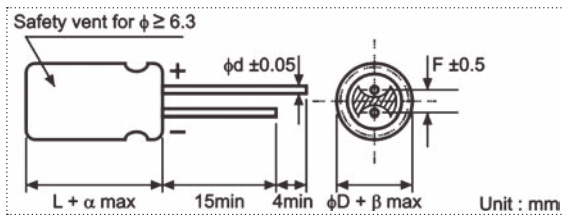

φD	5	6.3	8 (L < 20)	8 (L ≥ 20)	10	12.5	16	18	22	25
F	2.0	2.5	3.5	3.5	5.0	5.0	7.5	7.5	10.0	12.5
φd	0.5	0.5	0.5	0.6	0.6	0.6	0.8	0.8	0.8	1.0
α	(L < 20) 1.5				(L ≥ 20) 2.0					
β	(D < 20) 0.5				(D ≥ 20) 1.0					

PART NUMBER SYSTEM (EXAMPLE : 25V 330µF)



STANDARD RATINGS

Voltage (Code)		6.3V (0J)		10V (1A)		16V (1C)		25V (1E)	
Cap. (μF)	Code	Case Size	Ripple Current	Case Size	Ripple Current	Case Size	Ripple Current	Case Size	Ripple Current
4.7	475							5 x 11	26
10	106					5 x 11	35	5 x 11	38
22	226			5 x 11	49	5 x 11	54	5 x 11	57
33	336	5 x 11	54	5 x 11	60	5 x 11	64	5 x 11	75
47	476	5 x 11	65	5 x 11	70	5 x 11	80	5 x 11	84
68	686	5 x 11	70	5 x 11	75	5 x 11	90	5 x 11	92
100	107	5 x 11	95	5 x 11	105	5 x 11	125	5 x 11	140
						6.3 x 11	142	6.3 x 11	159
220	227	5 x 11	153	5 x 11	170	6.3 x 11	213	8 x 12	285
				6.3 x 11	193				
330	337	6.3 x 11	216	6.3 x 11	239	8 x 12	315	8 x 12	340
470	477	6.3 x 11	258	6.3 x 11	285	8 x 12	366	8 x 12	406
680	687	8 x 12	365	8 x 12	408	10 x 12.5	480	10 x 12.5	471
								10 x 16	620
1000	108	8 x 12	443	10 x 12.5	571	8 x 20	663	10 x 20	821
						10 x 16	680		
2200	228	10 x 16	740	10 x 20	886	12.5 x 20	1108	12.5 x 20	1176
								12.5 x 25	1296
3300	338	10 x 20	1032	12.5 x 20	1205	12.5 x 25	1389	16 x 25	1646
4700	478	12.5 x 20	1280	12.5 x 25	1492	16 x 25	1740	16 x 30	2012
6800	688	12.5 x 25	1554	16 x 25	1824	16 x 30	2081	16 x 35	2308
10000	109	16 x 25	1897	16 x 30	1980	16 x 35	2379	18 x 35	2500
15000	159	16 x 30	2188	16 x 40	2180	18 x 35	2600		
22000	229	18 x 35	2400	18 x 40	2407				
33000	339	18 x 40	2555						

Maximum Allowable Ripple Current (mArms) at 105°C 120Hz

Case Size Φ D x L (mm)

Voltage (Code)		35V (1V)		50V (1H)		63V (1J)		100V (2A)	
Cap. (μF)	Code	Case Size	Ripple Current	Case Size	Ripple Current	Case Size	Ripple Current	Case Size	Ripple Current
1	105			5 x 11	13			5 x 11	16
2.2	225			5 x 11	20			5 x 11	23
3.3	335			5 x 11	30			5 x 11	34
4.7	475	5 x 11	28	5 x 11	37	5 x 11	40	5 x 11	40
10	106	5 x 11	41	5 x 11	54	5 x 11	59	6.3 x 11	61
22	226	5 x 11	67	5 x 11	79	5 x 11	79	6.3 x 11	92
33	336	5 x 11	80	5 x 11	101	6.3 x 11	122	8 x 12	144
47	476	5 x 11	101	6.3 x 11	133	6.3 x 11	146	10 x 12.5	199
68	686	6.3 x 11	138	6.3 x 11	160	8 x 12	155	10 x 16	240
100	107	6.3 x 11	168	8 x 12	229	10 x 12.5	251	10 x 20	349
220	227	8 x 12	294	10 x 16	509	10 x 20	504	12.5 x 25	662
330	337	10 x 12.5	419	10 x 16	589	12.5 x 20	688	12.5 x 25	800
470	477	10 x 16	547	10 x 20	707	12.5 x 20	810	16 x 25	990
680	687	10 x 20	682	12.5 x 20	923	12.5 x 25	1160	16 x 30	1289
1000	108	12.5 x 20	1023	12.5 x 25	1287	16 x 25	1448	18 x 35	1903
				16 x 25	1478			18 x 40	2020
2200	228	16 x 25	1497	16 x 30	1759	18 x 35	1781		
				16 x 35	1884				
3300	338	16 x 30	1808	18 x 35	2167				
4700	478	18 x 35	2335						
6800	688	18 x 40	2400						

Maximum Allowable Ripple Current (mArms) at 105°C 120Hz

Case Size Φ D x L (mm)

Specifications are subject to change without notice. Should a safety or technical concern arise regarding the product, please be sure to contact our sales offices or agents immediately.

STANDARD RATINGS

Voltage (Code)		160V (2C)		200V (2D)		220V (2N)		250V (2E)	
Cap. (μF)	Code	Case Size	Ripple Current	Case Size	Ripple Current	Case Size	Ripple Current	Case Size	Ripple Current
0.47	474							6.3 x 11	8
1	105							6.3 x 11	17
2.2	225							6.3 x 11	27
3.3	335			6.3 x 11	30	6.3 x 11	30	6.3 x 11	35
4.7	475	6.3 x 11	41	6.3 x 11	40	8 x 12	40	8 x 12	45
10	106	8 x 12	60	10 x 12.5	72	10 x 12.5	70	10 x 12.5	75
				10 x 16	79				
22	226	10 x 16	110	10 x 16	113	10 x 20	125	10 x 20	130
33	336	10 x 20	156	10 x 20	165	12.5 x 20	165	12.5 x 20	184
47	476	10 x 20	195	10 x 20	194	12.5 x 20	220	12.5 x 25	238
68	686	12.5 x 20	250	12.5 x 20	226	12.5 x 25	245	16 x 20	246
				12.5 x 25	250				
82	826	12.5 x 25	310	10 x 30	320	12.5 x 30	280	16 x 25	351
100	107	12.5 x 25	360	16 x 25	386	16 x 25	335	16 x 25	390
								16 x 30	422
								18 x 30	440
150	157	12.5 x 30	380	16 x 25	525	16 x 30	365	18 x 30	440
180	187	12.5 x 35	420	12.5 x 35	560	16 x 35	500	18 x 35	469
220	227	16 x 30	680	16 x 30	643	16 x 40	615	18 x 35	485
				18 x 25	635				
270	277	16 x 30	728	18 x 30	740				
330	337	18 x 35	830	18 x 30	808				
				18 x 35	864				
390	397	18 x 35	850	18 x 35	904	18 x 40	959		
470	477	18 x 40	880	18 x 40	1016				
560	567	18 x 45	925	18 x 45	1112				

Maximum Allowable Ripple Current (mArms) at 105°C 120Hz

Case Size ΦD x L (mm)

STANDARD RATINGS

Voltage (Code)		350V (2V)		400V (2G)		420V (2M)		450V (2W)	
Cap. (μF)	Code	Case Size	Ripple Current	Case Size	Ripple Current	Case Size	Ripple Current	Case Size	Ripple Current
0.47	474	6.3 x 11	8	6.3 x 11	8	6.3 x 11	8		
1	105	6.3 x 11	18	6.3 x 11	19	6.3 x 11	15	6.3 x 11	16
2.2	225	6.3 x 11	25	6.3 x 11	25	8 x 12	29	8 x 12	24
3.3	335	8 x 12	40	8 x 12	35	8 x 12	35	8 x 12	29
4.7	475	8 x 12	43	8 x 12	40	10 x 12.5	46	10 x 12.5	37
				10 x 12.5	46	10 x 16	52	10 x 16	42
				8 x 16	68	10 x 16	77	10 x 20	74
10	106	10 x 16	73	10 x 12.5	70	10 x 20	85	12.5 x 20	84
				10 x 16	78				
18	186	12.5 x 20	100	12.5 x 20	105	12.5 x 25	124	10 x 30	108
				12.5 x 20	148	12.5 x 20	126	12.5 x 20	118
22	226	12.5 x 20	150	12.5 x 25	163	12.5 x 25	140	12.5 x 25	131
				10 x 30	192				
27	276	12.5 x 25	177	12.5 x 20	181	12.5 x 25	170	12.5 x 30	164
				12.5 x 20	175			16 x 20	215
33	336	16 x 25	200	12.5 x 25	193	16 x 25	200	16 x 25	237
39	396	16 x 25	258	16 x 25	251	12.5 x 30	248	12.5 x 35	256
				12.5 x 25	245	12.5 x 35	288	16 x 25	281
47	476	16 x 25	265	12.5 x 30	266			16 x 30	305
				16 x 20	256	18 x 20	277		
				12.5 x 30	313				
56	566	16 x 30	280	12.5 x 35	336	12.5 x 40	344	16 x 30	352
				16 x 25	365			16 x 30	342
68	686	16 x 30	288	16 x 30	396	16 x 30	408	18 x 30	366
				18 x 20	356				
				16 x 30	414	16 x 35	456		
82	826	18 x 30	372	18 x 25	409			18 x 30	440
				18 x 30	443	18 x 25	420		
				16 x 30	457			16 x 35	459
100	107	18 x 35	460	18 x 25	452	18 x 35	488	18 x 30	457
				18 x 30	489			18 x 35	490
				16 x 40	567	18 x 30	464		
120	127			18 x 30	532	18 x 40	528	18 x 40	592
				18 x 35	570				
				16 x 40	577	18 x 35	507	18 x 40	606
150	157			18 x 35	580				
				18 x 40	616	18 x 45	568	18 x 45	640
				18 x 40	636				
180	187			18 x 40	636	18 x 40	573		
				18 x 50	704	18 x 45	622		

Maximum Allowable Ripple Current (mArms) at 105°C 120Hz

Case Size Φ D x L (mm)

RIPPLE CURRENT MULTIPLIER

Frequency Coefficient

Rated Voltage	Coefficient		Freq. (Hz)				
	Cap. (μF)		50	120	300	1k	10k~
6.3~100V	≤47		0.75	1.00	1.35	1.57	2.00
	68~470		0.80	1.00	1.23	1.34	1.50
	≥560		0.85	1.00	1.10	1.13	1.15
160~450V	0.47~220		0.80	1.00	1.25	1.40	1.60
	≥270		0.90	1.00	1.10	1.13	1.15

Specifications are subject to change without notice. Should a safety or technical concern arise regarding the product, please be sure to contact our sales offices or agents immediately.

FEATURES

- For general purpose, -55°C to +105°C, 1,000 to 2,000 hours.
- Wide CV value range.
- Safety vent construction products.



SPECIFICATIONS

Item	Performance Characteristics									
Operating Temperature Range	-55 to +105°C									
Rated Working Voltage Range	6.3 to 100V									
Nominal Capacitance Range	2.2 to 22000µF									
Capacitance Tolerance	±20% at 120Hz, +20°C									
Leakage Current	I ≤ 0.01CV or 3 (µA) whichever is greater measured after 2 minutes application of rated working voltage at +20°C									
tan δ (120Hz, +20°C)	Working Voltage (V)	6.3	10	16	25	35	50	63	100	
	tan δ (max.)	0.28	0.24	0.20	0.16	0.14	0.12	0.10	0.08	
	For capacitance value >1000µF, add 0.02 per another 1000µF									
Low Temperature Characteristics	Impedance ratio max. at 120Hz									
	Working Voltage (V)	6.3	10	16	25	35	50	63	100	
	Z-25°C / Z+20°C	4	3	2	2	2	2	2	2	
	Z-40°C / Z+20°C	10	8	6	4	3	3	3	3	
For capacitance value >1000µF, add 0.5 per another 1000µF for Z-25°C / Z+20°C add 1.0 per another 1000µF for Z-40°C / Z+20°C										
High Temperature Loading	Test time	ΦD	5 ~ 8	10 ~ 18	Post test requirements at +20°C					
	Load life		1,000h	2,000h	Leakage current : ≤ Initial specified value					
	Test temperature		+105°C		Cap. change : within ±20% of the initial measured value					
Test conditions : Rated DC working voltage with rated ripple current										
tan δ : ≤ 200% of the initial specified value										
Shelf Life	At +105°C no voltage applied after 1,000 hours and then being stabilized at +20°C the capacitors shall meet the following limits									
	Leakage current : ≤ Initial specified value									
	Cap. change : within ±20% of the initial measured value									
tan δ : ≤ 200% of the initial specified value										
Industrial Standard	JIS C - 5101-4 (IEC 60384-4)									

CASE SIZE TABLE



	5	6.3	8 (L < 20)	8 (L ≥ 20)	10	12.5	16	18
F	2.0	2.5	3.5	3.5	5.0	5.0	7.5	7.5
φd	0.5	0.5	0.5	0.6	0.6	0.6	0.8	0.8
α	(L < 20) 1.5			(L ≥ 20) 2.0				
β	(D < 20) 0.5			(D ≥ 20) 1.0				

PART NUMBER SYSTEM (EXAMPLE : 16V 470µF)



STANDARD RATINGS

Voltage (Code)		6.3V (0J)		10V (1A)		16V (1C)		25V (1E)	
Cap. (µF)	Code	Case Size	Ripple Current	Case Size	Ripple Current	Case Size	Ripple Current	Case Size	Ripple Current
47	476							5 x 11	91
100	107					5 x 11	110	6.3 x 11	130
220	227	5 x 11	140			6.3 x 11	180	8 x 12	230
330	337			6.3 x 11	200	8 x 12	260	8 x 12	310
470	477	6.3 x 11	230	6.3 x 11	240	8 x 12	310	10 x 12.5	380
1000	108	8 x 12	380	10 x 12.5	460	10 x 16	560	10 x 20	680
2200	228	10 x 16	710	10 x 20	760	12.5 x 20	920	12.5 x 20	988
3300	338	10 x 20	840	12.5 x 20	1000	12.5 x 25	1170	16 x 25	1400
4700	478	12.5 x 20	1090	12.5 x 25	1260	16 x 25	1480	16 x 30	1750
6800	688	12.5 x 25	1350	16 x 25	1570	16 x 30	1780	16 x 35	1910
10000	109	16 x 25	1650	16 x 30	1890	16 x 35	1930		
15000	159	16 x 30	2010	16 x 40	2170				
22000	229	18 x 35	2350						

Maximum Allowable Ripple Current (mArms) at 105°C 120Hz

Case Size ΦD x L (mm)

Voltage (Code)		35V (1V)		50V (1H)		63V (1J)		100V (2A)	
Cap. (µF)	Code	Case Size	Ripple Current	Case Size	Ripple Current	Case Size	Ripple Current	Case Size	Ripple Current
2.2	225			5 x 11	18			5 x 11	21
3.3	335			5 x 11	22			5 x 11	31
4.7	475			5 x 11	26			5 x 11	38
10	106			5 x 11	39	5 x 11	46	6.3 x 11	54
22	226			5 x 11	65	5 x 11	71	6.3 x 11	93
33	336			5 x 11	90	6.3 x 11	100	8 x 12	130
47	476	5 x 11	90	6.3 x 11	110	6.3 x 11	120	10 x 12.5	165
100	107	6.3 x 11	150	8 x 12	180	10 x 12.5	215	10 x 20	265
220	227	8 x 12	270	10 x 16	330	10 x 20	370	12.5 x 25	440
330	337	10 x 12.5	350	10 x 16	410	12.5 x 20	578	12.5 x 25	600
470	477	10 x 16	460	10 x 20	530	12.5 x 20	640	16 x 25	715
1000	108	12.5 x 20	810	12.5 x 25	950	16 x 25	930	18 x 40	1040
2200	228	16 x 25	1260	16 x 35	1570	18 x 35	1610		
3300	338	16 x 30	1610	18 x 35	1770				
4700	478	18 x 35	1910						

Maximum Allowable Ripple Current (mArms) at 105°C 120Hz

Case Size ΦD x L (mm)

RIPPLE CURRENT MULTIPLIER

Frequency Coefficient

Coefficient Cap. (µF)	Freq. (Hz)	60	120	1k	10k	100k
0.1~33		0.75	1.00	1.55	1.80	2.00
47~470		0.80	1.00	1.35	1.50	1.50
1000~22000		0.85	1.00	1.10	1.15	1.15

Specifications are subject to change without notice. Should a safety or technical concern arise regarding the product, please be sure to contact our sales offices or agents immediately.

FEATURES

- Doesn't spark with DC over voltage.
- Load life: 2,000 hours at 105°C.



SPECIFICATIONS

Item	Performance Characteristics		
Operating Temperature Range	-25 to +105°C		
Rated Working Voltage Range	200 & 400V		
Nominal Capacitance Range	22 to 330µF		
Capacitance Tolerance	±20% at 120Hz, +20°C		
Leakage Current	I ≤ 0.03CV + 40 (µA) after 2 minutes application of rated working voltage at +20°C		
tan δ (120Hz, +20°C)	Working Voltage (V)	200	400
	tan δ (max.)	0.20	0.24
Low Temperature Characteristics	Impedance ratio max. at 120Hz		
	Rated Voltage (V)	200	400
High Temperature Loading	Z-25°C / Z+20°C	3	6
	Test time	: 2,000 hours	Post test requirements at +20°C
	Test temperature	: +105°C	Leakage current : ≤ Initial specified value
	Test conditions	: Rated DC working voltage with rated ripple current	Cap. change : within ±20% of the initial measured value tan δ : ≤ 200% of the initial specified value
Shelf Life	At +105°C no voltage applied after 1,000 hours and then being stabilized at +20°C the capacitors shall meet the following limits		
	Leakage current	: ≤ Initial specified value	
	Cap. change	: within ±20% of the initial measured value	
	tan δ	: ≤ 200% of the initial specified value	
Industrial Standard	JIS C - 5101-4 (IEC 60384-4)		

CASE SIZE TABLE



φ D	16	18
F	7.5	7.5
φ d	0.8	0.8
α	(L < 20) 1.5	(L ≥ 20) 2.0
β	(D < 20) 0.5	(D ≥ 20) 1.0

RIPPLE CURRENT MULTIPLIER

Frequency Coefficient

Coefficient	50	120	300	1k	10k~
Cap (µF)					
22~220	0.80	1.00	1.25	1.40	1.60
270~330	0.90	1.00	1.10	1.13	1.15

PART NUMBER SYSTEM (EXAMPLE : 200V 100µF)



STANDARD RATINGS

Voltage (Code)		200V (2D)		400V (2G)	
Cap. (µF)	Code	Case Size	Ripple Current	Case Size	Ripple Current
22	226			16 x 20	145
33	336			16 x 25	220
				18 x 20	225
39	396			16 x 30	245
				18 x 25	250
47	476			16 x 30	275
				18 x 25	280
56	566			16 x 40	350
				18 x 30	315
68	686			18 x 35	350
82	826	16 x 20	230	18 x 40	395
100	107	16 x 25	425		
		18 x 20	250	18 x 40	450
120	127	16 x 30	500		
		18 x 25	475		
150	157	16 x 30	560		
		18 x 25	530		
180	187	16 x 40	645		
		18 x 30	630		
220	227	18 x 35	725		
270	277	18 x 45	830		
330	337	18 x 45	920		

Maximum Allowable Ripple Current (mArms) at 105°C 120Hz

Case Size Φ D x L (mm)

DC OVERVOLTAGE TEST CONDITIONS

They vent will operate and the capacitor shall become an open circuit without buming materials when the following excess DC voltage is applied.

● Test DC voltage

Rated voltage	Current limit	Test DC voltage
200Vdc	4A	300 / 375Vdc
400Vdc	2A	500 / 600Vdc

● Test circuit



Constant DC voltage / current power supply

Specifications are subject to change without notice. Should a safety or technical concern arise regarding the product, please be sure to contact our sales offices or agents immediately.

FEATURES

- Low impedance for high frequency.
- Life time: 1,000~4,000 hours at 105°C.



SPECIFICATIONS

Item	Performance Characteristics																				
Operating Temperature Range	-40 to +105°C																				
Rated Working Voltage Range	6.3 to 100V																				
Nominal Capacitance Range	3.3 to 4700µF																				
Capacitance Tolerance	±20% at 120Hz, +20°C																				
Leakage Current	I ≤ 0.01CV or 3 (µA) whichever is greater measured after 2 minutes application of rated working voltage at +20°C																				
tan δ (120Hz, +20°C)	Working Voltage (V)	6.3	10	16	25	35	50	63	100												
	tan δ (max.)	0.22	0.19	0.16	0.14	0.12	0.10	0.09	0.08												
For capacitance value >1000µF, add 0.02 per another 1000µF																					
Low Temperature Characteristics	Impedance ratio max. at 120Hz																				
	Working Voltage (V)	6.3	10	16	25	35	50	63	100												
	Z-25°C / Z+20°C	4	3	2	2	2	2	2	2												
Z-40°C / Z+20°C																					
8 6 4 3 3 3 3 3 3																					
High Temperature Loading	Test time	<table border="1"> <tr> <td>φD</td> <td>L ≤ 7</td> <td>D5-6.3</td> <td>D8-10</td> <td>D12.5</td> </tr> <tr> <td>Load life</td> <td>1,000h</td> <td>2,000h</td> <td>3,000h</td> <td>4,000h</td> </tr> </table>				φD	L ≤ 7	D5-6.3	D8-10	D12.5	Load life	1,000h	2,000h	3,000h	4,000h	Post test requirements at +20°C					
	φD	L ≤ 7	D5-6.3	D8-10	D12.5																
Load life	1,000h	2,000h	3,000h	4,000h																	
Test temperature	+105°C				Leakage current : ≤ Initial specified value																
Test conditions	Rated DC working voltage with rated ripple current				Cap. change : within ±25% of the initial measured value																
tan δ : ≤ 150% of the initial specified value																					
Shelf Life	At +105°C no voltage applied after 1,000 hours and then being stabilized at +20°C the capacitors shall meet the following limits																				
Leakage current : ≤ Initial specified value																					
Cap. change : within ±25% of the initial measured value																					
tan δ : ≤ 150% of the initial specified value																					
Industrial Standard	JIS C - 5101-4 (IEC 60384-4)																				

CASE SIZE TABLE



φD	4	5	6.3	8 (L < 20)	8 (L ≥ 20)	10	12.5
F	1.5	2.0	2.5	3.5	3.5	5.0	5.0
φd	0.45	(L ≤ 7) 0.45	(L ≥ 9) 0.50	0.6	0.6	0.6	0.6
α	(L ≤ 7) 1		(L ≤ 9 < 20) 1.5		(L ≥ 20) 2.0		
β	(D < 20) 0.5				(D ≥ 20) 1.0		

PART NUMBER SYSTEM (EXAMPLE : 6.3V 1000µF)



STANDARD RATINGS

Voltage (Code)		6.3V (0J)			10V (1A)			16V (1C)		
Cap. (μF)	Code	Case Size	Impedance	Ripple Current	Case Size	Impedance	Ripple Current	Case Size	Impedance	Ripple Current
10	106							4 x 5	5.000	50
15	156							4 x 7	3.300	70
								5 x 5	2.600	80
22	226	4 x 5	5.000	50	4 x 7	3.300	70	5 x 7	1.700	110
					5 x 5	2.600	80	5 x 5	2.600	80
33	336	5 x 5	2.600	80	5 x 5	2.600	80	6.3 x 5	1.300	115
		5 x 7	1.700	110	5 x 7	1.700	110	6.3 x 7	0.800	160
47	476	5 x 5	2.600	80	6.3 x 5	1.300	115	6.3 x 5	1.300	115
		5 x 7	1.700	110	6.3 x 7	0.800	160	6.3 x 7	0.800	160
68	686	6.3 x 5	1.300	115	6.3 x 7	0.800	160	8 x 7	0.500	200
		6.3 x 7	0.800	160						
100	107	6.3 x 5	1.300	115	8 x 7	0.500	200	6.3 x 11	0.220	340
		6.3 x 7	0.800	160				8 x 7	0.500	200
120	127							6.3 x 11	0.220	340
150	157	8 x 7	0.500	200	6.3 x 11	0.220	340	6.3 x 11	0.220	340
					8 x 7	0.500	200	8 x 12	0.130	640
180	187	6.3 x 11	0.220	340	6.3 x 11	0.220	340	6.3 x 11	0.220	340
								8 x 12	0.130	640
220	227	8 x 7	0.500	200	6.3 x 11	0.220	340	6.3 x 11	0.220	340
		6.3 x 11	0.220	340				8 x 12	0.130	640
270	277	6.3 x 11	0.220	340	6.3 x 11	0.220	340	8 x 12	0.130	640
					8 x 12	0.130	640			
330	337	6.3 x 11	0.220	340	6.3 x 11	0.220	340	6.3 x 11	0.220	340
		8 x 12	0.130	640	8 x 12	0.130	640	8 x 12	0.130	640
390	397	8 x 12	0.130	640	8 x 12	0.130	640	8 x 12	0.130	640
470	477	8 x 12	0.130	640	6.3 x 11	0.220	340	8 x 12	0.130	640
					8 x 12	0.130	640	10 x 12.5	0.080	865
560	567	8 x 12	0.130	640	8 x 12	0.130	640	10 x 12.5	0.080	865
680	687	8 x 12	0.130	640	8 x 12	0.130	640	8 x 16	0.087	840
								10 x 12.5	0.080	865
820	827	8 x 12	0.130	640	10 x 12.5	0.080	865	10 x 16	0.060	1210
		10 x 12.5	0.080	865						
1000	108	8 x 12	0.130	640	8 x 16	0.087	840	8 x 16	0.087	840
		10 x 12.5	0.080	865	10 x 16	0.060	1210	10 x 16	0.060	1210
1200	128	8 x 16	0.087	840	10 x 20	0.046	1400	10 x 20	0.046	1400
		10 x 12.5	0.080	865						
1500	158	8 x 20	0.069	1050	10 x 20	0.046	1400	10 x 20	0.046	1400
		10 x 16	0.060	1210						
1800	188	10 x 20	0.046	1400	10 x 20	0.046	1400	10 x 25	0.042	1650
								12.5 x 20	0.035	1900
2200	228	10 x 20	0.046	1400	10 x 20	0.046	1400	10 x 25	0.042	1650
								12.5 x 20	0.035	1900
2700	278	10 x 25	0.042	1650	10 x 25	0.042	1650	12.5 x 25	0.030	2124
		12.5 x 20	0.035	1900	12.5 x 20	0.035	1900			
3300	338	10 x 25	0.042	1650	12.5 x 25	0.030	2124	12.5 x 25	0.030	2124
		12.5 x 20	0.035	1900						
3900	398	12.5 x 20	0.035	1900						
4700	478	12.5 x 25	0.030	2124						

Maximum Allowable Ripple Current (mArms) at 105°C 100kHz

Case Size Φ D x L (mm)

Maximum Impedance (Ω) at 20°C 100kHz

Specifications are subject to change without notice. Should a safety or technical concern arise regarding the product, please be sure to contact our sales offices or agents immediately.

STANDARD RATINGS

Voltage (Code)		25V (1E)			35V (1V)			50V (1H)		
Cap. (µF)	Code	Case Size	Impedance	Ripple Current	Case Size	Impedance	Ripple Current	Case Size	Impedance	Ripple Current
3.3	335				4 x 5	5.000	50			
4.7	475	4 x 5	5.000	50	4 x 5	5.000	50			
6.8	685	4 x 5	5.000	50	4 x 7	3.300	70			
					5 x 5	2.600	80			
10	106	4 x 7	3.300	70	5 x 5	2.600	80			
		5 x 5	2.600	80	5 x 7	1.700	110			
15	156	5 x 7	1.700	110	6.3 x 5	1.300	115			
		6.3 x 5	1.300	115	6.3 x 7	0.800	160			
22	226	5 x 7	1.700	110	6.3 x 5	1.300	115			
		6.3 x 5	1.300	115	6.3 x 7	0.800	160			
33	336	6.3 x 5	1.300	115	8 x 7	0.500	200	6.3 x 11	0.300	295
		6.3 x 7	0.800	160						
39	396							6.3 x 11	0.300	295
47	476	8 x 7	0.500	200	6.3 x 11	0.220	340	6.3 x 11	0.300	295
56	566				6.3 x 11	0.220	340	8 x 12	0.170	555
68	686	8 x 7	0.500	200	6.3 x 11	0.220	340	8 x 12	0.170	555
82	826	6.3 x 11	0.220	340	8 x 12	0.130	640	8 x 12	0.170	555
100	107	6.3 x 11	0.220	340	6.3 x 11	0.220	340	10 x 12.5	0.120	760
					8 x 12	0.130	640			
120	127	8 x 12	0.130	640	8 x 12	0.130	640	8 x 16	0.120	730
								10 x 12.5	0.120	760
150	157	8 x 12	0.130	640	8 x 12	0.130	640	10 x 16	0.084	1050
180	187	8 x 12	0.130	640	10 x 12.5	0.080	865	8 x 20	0.091	910
								10 x 16	0.084	1050
220	227	8 x 12	0.130	640	8 x 12	0.130	640	8 x 20	0.091	910
					8 x 16	0.087	840			
					10 x 12.5	0.080	865			
270	277	8 x 12	0.130	640	10 x 16	0.060	1210	10 x 25	0.055	1440
		10 x 12.5	0.080	865						
330	337	8 x 12	0.130	640	8 x 16	0.087	840	12.5 x 20	0.045	1660
					8 x 20	0.069	1050			
		10 x 12.5	0.080	865	10 x 16	0.060	1210			
390	397	10 x 12.5	0.080	865	10 x 16	0.060	1210	12.5 x 20	0.045	1660
470	477	8 x 16	0.087	840	10 x 16	0.060	1210	12.5 x 25	0.034	1950
		10 x 12.5	0.080	865						
		10 x 16	0.060	1210	10 x 20	0.046	1400			
560	567	10 x 16	0.060	1210	10 x 20	0.046	1400	12.5 x 25	0.034	1950
680	687	10 x 16	0.060	1210	10 x 20	0.046	1400			
		10 x 20	0.046	1400	12.5 x 20	0.035	1900			
820	827	10 x 20	0.046	1400	10 x 25	0.042	1650			
					12.5 x 20	0.035	1900			
1000	108	10 x 20	0.046	1400	12.5 x 20	0.035	1900			
					12.5 x 25	0.030	2124			
1200	128	10 x 20	0.046	1400						
1500	158	10 x 25	0.042	1650						
		12.5 x 20	0.035	1900						
1800	188	12.5 x 25	0.030	2124						
2200	228	12.5 x 25	0.030	2124						

Maximum Allowable Ripple Current (mArms) at 105°C 100kHz

Case Size Φ D x L (mm)

Maximum Impedance (Ω) at 20°C 100kHz

Specifications are subject to change without notice. Should a safety or technical concern arise regarding the product, please be sure to contact our sales offices or agents immediately.

STANDARD RATINGS

Voltage (Code)		63V (1J)			100V (2A)		
Cap. (μF)	Code	Case Size	Impedance	Ripple Current	Case Size	Impedance	Ripple Current
15	156				6.3 x 11	0.960	115
22	226	6.3 x 11	0.960	115			
27	276	6.3 x 11	0.960	115	8 x 12	0.504	232
33	336	6.3 x 11	0.960	115			
39	396	8 x 12	0.504	232	8 x 16	0.360	300
47	476	8 x 12	0.504	232	10 x 12.5	0.344	314
56	566	8 x 12	0.504	232	8 x 20	0.264	362
68	686	8 x 12	0.504	232	10 x 16	0.248	357
82	826	10 x 12.5	0.344	314	10 x 20	0.168	466
100	107	8 x 16	0.360	300	10 x 20	0.168	466
		10 x 12.5	0.344	314	12.5 x 20	0.128	690
120	127	8 x 16	0.360	300	12.5 x 20	0.128	690
		10 x 16	0.248	357			
150	157	8 x 20	0.264	362			
180	187	10 x 20	0.168	466	12.5 x 25	0.096	922
220	227	10 x 16	0.248	357	12.5 x 25	0.096	922
		10 x 20	0.168	466			
270	277	12.5 x 20	0.128	690			
330	337	12.5 x 20	0.128	690			
390	397	12.5 x 25	0.096	922			

Maximum Allowable Ripple Current (mArms) at 105°C 100kHz

Case Size Φ D x L (mm)

Maximum Impedance (Ω) at 20°C 100kHz

RIPPLE CURRENT MULTIPLIER

Frequency Coefficient

Coefficient Cap. (μF)	Freq. (Hz)	120	1k	10k	100k
≤180		0.40	0.75	0.90	1.00
220~560		0.50	0.85	0.94	1.00
680~1800		0.60	0.87	0.95	1.00
2200~3900		0.75	0.90	0.95	1.00
4700		0.85	0.95	0.98	1.00

Specifications are subject to change without notice. Should a safety or technical concern arise regarding the product, please be sure to contact our sales offices or agents immediately.

FEATURES

- Low impedance for high frequency.
- Long life: 3,000~6,000 hours at 105°C.



SPECIFICATIONS

Item	Performance Characteristics
Operating Temperature Range	-40 to +105°C
Rated Working Voltage Range	6.3 to 100V
Nominal Capacitance Range	15 to 3900μF
Capacitance Tolerance	±20% at 120Hz, +20°C
Leakage Current	I ≤ 0.01CV or 3 (μA) whichever is greater measured after 2 minutes application of rated working voltage at +20°C
tan δ (120Hz, +20°C)	Working Voltage (V)
	tan δ (max.)
Low Temperature Characteristics	Impedance ratio max. at 120Hz
	Working Voltage (V)
	Z-25°C / Z+20°C
	Z-40°C / Z+20°C
High Temperature Loading	Test time
	Post test requirements at +20°C
Shelf Life	At +105°C no voltage applied after 1,000 hours and then being stabilized at +20°C the capacitors shall meet the following limits
	Leakage current : ≤ Initial specified value
Industrial Standard	JIS C - 5101-4 (IEC 60384-4)

CASE SIZE TABLE



φD	6.3	8 (L < 20)	8 (L ≥ 20)	10	12.5
F	2.5	3.5	3.5	5.0	5.0
φd	0.5	0.5	0.6	0.6	0.6
α		(L < 20) 1.5		(L ≥ 20) 2.0	
β		(D < 20) 0.5		(D ≥ 20) 1.0	

RIPPLE CURRENT MULTIPLIER

Frequency Coefficient

Coefficient	50	120	300	1k	100k
15~33	0.45	0.55	0.70	0.90	1.00
39~330	0.60	0.70	0.85	0.95	1.00
470~1000	0.65	0.75	0.90	0.98	1.00
1200~3900	0.75	0.80	0.95	1.00	1.00

PART NUMBER SYSTEM (EXAMPLE : 10V 1500μF)





SF

Miniature Aluminum Electrolytic Capacitors

STANDARD RATINGS

Voltage (Code)		6.3V (0J)			10V (1A)			16V (1C)		
Cap. (μF)	Code	Case Size	Impedance	Ripple Current	Case Size	Impedance	Ripple Current	Case Size	Impedance	Ripple Current
120	127							6.3 x 11	0.220	340
220	227				6.3 x 11	0.220	340			
330	337	6.3 x 11	0.220	340				8 x 12	0.130	640
470	477				8 x 12	0.130	640	8 x 12	0.130	640
								8 x 16	0.087	840
								10 x 12.5	0.080	865
680	687	8 x 12	0.130	640	8 x 16	0.087	840	8 x 20	0.069	1050
					10 x 12.5	0.080	865	10 x 12.5	0.080	865
820	827	10 x 12.5	0.080	865				10 x 16	0.060	1210
1000	108	8 x 16	0.087	840	8 x 20	0.069	1050	10 x 16	0.060	1210
					10 x 16	0.060	1210	10 x 20	0.046	1400
1200	128	8 x 20	0.069	1050	10 x 20	0.046	1400	10 x 25	0.042	1650
		10 x 16	0.060	1210						
1500	158	10 x 20	0.046	1400	10 x 25	0.042	1650	12.5 x 20	0.035	1900
2200	228	10 x 25	0.042	1650	12.5 x 20	0.035	1900	12.5 x 20	0.035	1900
								12.5 x 25	0.030	2124
3300	338	12.5 x 20	0.035	1900	12.5 x 25	0.030	2124			
3900	398	12.5 x 25	0.030	2124						

Maximum Allowable Ripple Current (mArms) at 105°C 100kHz
Maximum Impedance (Ω) at 20°C 100kHz
Case Size ΦD x L (mm)

Voltage (Code)		25V (1E)			35V (1V)			50V (1H)		
Cap. (μF)	Code	Case Size	Impedance	Ripple Current	Case Size	Impedance	Ripple Current	Case Size	Impedance	Ripple Current
56	566				6.3 x 11	0.220	340	6.3 x 11	0.300	295
100	107	6.3 x 11	0.220	340				8 x 12	0.170	555
120	127							8 x 16	0.120	730
150	157				8 x 12	0.130	640	10 x 12.5	0.120	760
220	227	6.3 x 11	0.220	340	8 x 16	0.087	840	10 x 16	0.084	1050
		8 x 12	0.130	640	10 x 12.5	0.080	865			
330	337	8 x 16	0.087	840	10 x 12.5	0.080	865	10 x 25	0.055	1440
		10 x 12.5	0.080	865	10 x 16	0.060	1210			
470	477	8 x 20	0.069	1050	10 x 20	0.046	1400	10 x 20	0.060	1210
		10 x 16	0.060	1210				12.5 x 20	0.045	1660
560	567				10 x 25	0.042	1650	12.5 x 25	0.034	1950
680	687	10 x 16	0.060	1210	12.5 x 20	0.035	1900	10 x 30	0.043	1690
		10 x 20	0.046	1400						
820	827	10 x 25	0.042	1650						
1000	108	12.5 x 20	0.035	1900	12.5 x 20	0.035	1900			
					12.5 x 25	0.030	2124			
1500	158	12.5 x 25	0.030	2124						

Maximum Allowable Ripple Current (mArms) at 105°C 100kHz
Maximum Impedance (Ω) at 20°C 100kHz
Case Size ΦD x L (mm)

Voltage (Code)		63V (1J)			100V (2A)		
Cap. (μF)	Code	Case Size	Impedance	Ripple Current	Case Size	Impedance	Ripple Current
15	156				6.3 x 11	0.960	115
27	276				8 x 12	0.504	232
33	336	6.3 x 11	0.960	115			
39	396				8 x 16	0.360	300
47	476				10 x 12.5	0.344	314
56	566	8 x 12	0.504	232	8 x 20	0.264	362
68	686				10 x 16	0.248	357
82	826	8 x 16	0.360	300			
		10 x 12.5	0.344	314	10 x 20	0.168	466
100	107				10 x 20	0.168	466
					10 x 25	0.160	531
120	127	8 x 20	0.264	362	12.5 x 20	0.128	690
		10 x 16	0.248	357			
180	187	10 x 20	0.168	466	12.5 x 25	0.096	922
220	227	10 x 25	0.160	531			
270	277	12.5 x 20	0.128	690			
330	337	12.5 x 25	0.096	922			

Maximum Allowable Ripple Current (mArms) at 105°C 100kHz
Maximum Impedance (Ω) at 20°C 100kHz
Case Size ΦD x L (mm)

Specifications are subject to change without notice. Should a safety or technical concern arise regarding the product, please be sure to contact our sales offices or agents immediately.

FEATURES

- Low impedance for high frequency.
- Load life of 4,000~10,000 hours at 105°C.



SPECIFICATIONS

Item	Performance Characteristics									
Operating Temperature Range	-40 to +105°C									
Rated Working Voltage Range	6.3 to 100V									
Nominal Capacitance Range	15 to 3900µF									
Capacitance Tolerance	±20% at 120Hz, +20°C									
Leakage Current	I ≤ 0.01CV or 3 (µA)									
	whichever is greater measured after 2 minutes application of rated working voltage at +20°C									
tan δ (120Hz, +20°C)	Working Voltage (V)	6.3	10	16	25	35	50	63	100	
	tan δ (max.)	0.22	0.19	0.16	0.14	0.12	0.10	0.09	0.08	
	For capacitance value >1000µF, add 0.02 per another 1000µF									
Low Temperature Characteristics	Impedance ratio max. at 120Hz									
	Rated Voltage (V)	6.3	10	16	25	35	50	63	100	
	Z-25°C / Z+20°C	4	3	2	2	2	2	2	2	
	Z-40°C / Z+20°C	8	6	4	3	3	3	3	3	
High Temperature Loading	Test time	ΦD	5-63	8-10	125	Post test requirements at +20°C				
		63-10WV	4,000h	6,000h	8,000h	Leakage current : ≤Initial specified value				
	Test temperature	16-100WV	5,000h	7,000h	10,000h	Cap. change : within ±25% of the initial measured value				
		+105°C				tan δ : ≤200% of the initial specified value				
Test conditions		Rated DC working voltage with rated ripple current								
Shelf Life	At +105°C no voltage applied after 1,000 hours and then being stabilized at +20°C the capacitors shall meet the following limits									
	Leakage current : ≤Initial specified value									
	Cap. change : within ±25% of the initial measured value									
Industrial Standard	tan δ : ≤200% of the initial specified value									
	JIS C - 5101-4 (IEC 60384-4)									

CASE SIZE TABLE



ΦD	6.3	8 (L <20)	8 (L ≥20)	10	12.5
F	2.5	3.5	3.5	5.0	5.0
Φd	0.5	0.5	0.6	0.6	0.6
α	(L <20) 1.5			(L ≥20) 2.0	
β	(D <20) 0.5			(D ≥20) 1.0	

RIPPLE CURRENT MULTIPLIER

Frequency Coefficient

Coefficient	Freq. (Hz)				
Cap (µF)	50	120	300	1k	100k
15~33	0.45	0.55	0.70	0.90	1.00
39~330	0.60	0.70	0.85	0.95	1.00
390~1000	0.65	0.75	0.90	0.98	1.00
1200~3900	0.75	0.80	0.95	1.00	1.00

PART NUMBER SYSTEM (EXAMPLE : 10V 3300µF)



+105°C, High Ripple Current (高紋波), Longer Life Assurance (較長壽命), Low Impedance (低阻抗品)

STANDARD RATINGS

Voltage (Code)		6.3V (0J)			10V (1A)			16V (1C)		
Cap. (μF)	Code	Case Size	Impedance	Ripple Current	Case Size	Impedance	Ripple Current	Case Size	Impedance	Ripple Current
120	127							6.3 x 11	0.220	340
220	227				6.3 x 11	0.220	340	6.3 x 11	0.220	340
330	337	6.3 x 11	0.220	340				8 x 12	0.130	640
470	477				6.3 x 11	0.220	340	8 x 12	0.130	640
					8 x 12	0.130	640	8 x 16	0.087	840
680	687	8 x 12	0.130	640	8 x 16	0.087	840	8 x 16	0.087	840
					10 x 12.5	0.080	865	8 x 20	0.069	1050
820	827	10 x 12.5	0.080	865				8 x 20	0.069	1050
1000	108	8 x 16	0.087	840	8 x 20	0.069	1050	10 x 16	0.060	1210
		10 x 12.5	0.080	865	10 x 16	0.060	1210	10 x 20	0.046	1400
1200	128	8 x 20	0.069	1050	10 x 20	0.046	1400	10 x 20	0.046	1400
		10 x 16	0.060	1210				10 x 25	0.042	1650
1500	158	10 x 20	0.046	1400	10 x 25	0.042	1650	10 x 30	0.031	1910
								12.5 x 20	0.035	1900
2200	228	10 x 25	0.042	1650	10 x 30	0.031	1910	12.5 x 25	0.030	2124
					12.5 x 20	0.035	1900			
2700	278	10 x 30	0.031	1910						
3300	338	12.5 x 20	0.035	1900	12.5 x 25	0.030	2124			
3900	398	12.5 x 25	0.030	2124						

Maximum Allowable Ripple Current (mArms) at 105°C 100kHz

Case Size φD x L (mm)

Maximum Impedance (Ω) at 20°C 100kHz

Voltage (Code)		25V (1E)			35V (1V)			50V (1H)		
Cap. (μF)	Code	Case Size	Impedance	Ripple Current	Case Size	Impedance	Ripple Current	Case Size	Impedance	Ripple Current
56	566				6.3 x 11	0.220	340	6.3 x 11	0.300	295
100	107	6.3 x 11	0.220	340	6.3 x 11	0.220	340	8 x 12	0.170	555
120	127							8 x 16	0.120	730
150	157				8 x 12	0.130	640	10 x 12.5	0.120	760
220	227	8 x 12	0.130	640	8 x 16	0.087	840	8 x 16	0.120	730
					10 x 12.5	0.080	865	10 x 12.5	0.120	760
330	337	8 x 16	0.087	840	10 x 16	0.060	1210	10 x 16	0.084	1050
		10 x 12.5	0.080	865				10 x 25	0.055	1440
470	477	8 x 16	0.087	840				10 x 20	0.060	1220
		8 x 20	0.069	1050	10 x 20	0.046	1400	10 x 30	0.043	1690
		10 x 16	0.060	1210				12.5 x 20	0.045	1660
560	567				10 x 25	0.042	1650	12.5 x 25	0.034	1950
680	687	8 x 20	0.069	1050	10 x 30	0.031	1910	12.5 x 20	0.045	1660
		10 x 20	0.046	1400	12.5 x 20	0.035	1900			
820	827	10 x 25	0.042	1650				12.5 x 25	0.034	1950
		10 x 25	0.042	1650						
1000	108	10 x 30	0.031	1910	12.5 x 25	0.030	2124	12.5 x 25	0.034	1950
		12.5 x 20	0.035	1900						
1500	158	12.5 x 20	0.035	1900						
		12.5 x 25	0.030	2124						

Maximum Allowable Ripple Current (mArms) at 105°C 100kHz

Case Size φD x L (mm)

Maximum Impedance (Ω) at 20°C 100kHz

Specifications are subject to change without notice. Should a safety or technical concern arise regarding the product, please be sure to contact our sales offices or agents immediately.

STANDARD RATINGS

Voltage (Code)		63V (1J)			100V (2A)		
Cap. (µF)	Code	Case Size	Impedance	Ripple Current	Case Size	Impedance	Ripple Current
15	156				6.3 x 11	0.960	115
27	276				8 x 12	0.504	232
33	336	6.3 x 11	0.960	115			
39	396				8 x 16	0.360	300
47	476				10 x 12.5	0.344	314
56	566	8 x 12	0.504	232	8 x 20	0.264	362
68	686	8 x 12	0.504	232	10 x 16	0.248	357
82	826	8 x 16	0.360	300	10 x 20	0.168	466
		10 x 12.5	0.344	314			
100	107				10 x 20	0.168	466
					10 x 25	0.160	531
120	127	8 x 20	0.264	362	10 x 30	0.120	663
		10 x 16	0.248	357	12.5 x 20	0.128	690
180	187	10 x 20	0.168	466	12.5 x 25	0.096	922
220	227	10 x 25	0.160	531			
270	277	10 x 20	0.168	466			
		10 x 30	0.120	663			
		12.5 x 20	0.128	690			
330	337	12.5 x 20	0.128	690			
		12.5 x 25	0.096	922			
470	477	12.5 x 25	0.096	922			

Maximum Allowable Ripple Current (mArms) at 105°C 100kHz

Case Size ϕ D x L (mm)

Maximum Impedance (Ω) at 20°C 100kHz

FEATURES

- Load life of 2,000~5,000 hours at 105°C.
- Enabled high ripple current by a reduction of impedance at high frequency range.
- Lowest impedance for personal computer and storage equipment.



SPECIFICATIONS

Item	Performance Characteristics					
Operating Temperature Range	-40 to +105°C					
Rated Working Voltage Range	6.3 to 25V					
Nominal Capacitance Range	100 to 3900µF					
Capacitance Tolerance	±20% at 120Hz, +20°C					
Leakage Current	I ≤ 0.01CV or 3 (µA) whichever is greater measured after 2 minutes application of rated working voltage at +20°C					
tan δ (120Hz, +20°C)	Working Voltage (V)	6.3	10	16	25	
	tan δ (max.)	0.22	0.19	0.16	0.14	
For capacitance value >1000µF, add 0.02 per another 1000µF						
Low Temperature Characteristics	Impedance ratio max. at 120Hz					
	Working Voltage (V)	6.3	10	16	25	
Z-25°C / Z+20°C						
High Temperature Loading	Test time	ΦD	6.3	8	10	12.5
	Load life		2,000h	3,000h	4,000h	5,000h
	Test temperature	: +105°C				
Test conditions : Rated DC working voltage with rated ripple current						
Post test requirements at +20°C						
Leakage current : ≤ Initial specified value						
Cap. change : within ±25% of the initial measured value						
tan δ : ≤ 200% of the initial specified value						
Shelf Life	At +105°C no voltage applied after 1,000 hours and then being stabilized at +20°C the capacitors shall meet the following limits					
Leakage current : ≤ Initial specified value						
Cap. change : within ±25% of the initial measured value						
tan δ : ≤ 200% of the initial specified value						
Industrial Standard	JIS C - 5101-4 (IEC 60384-4)					

CASE SIZE TABLE



	ΦD	6.3	8 (L < 20)	8 (L ≥ 20)	10	12.5
F		2.5	3.5	3.5	5.0	5.0
Φd		0.5	0.5	0.6	0.6	0.6
α			(L < 20) 1.5		(L ≥ 20) 2.0	
β			(D < 20) 0.5		(D ≥ 20) 1.0	

RIPPLE CURRENT MULTIPLIER

Frequency Coefficient

Coefficient	Freq. (Hz)	120	1k	10k	100k
Cap (µF)	100~180	0.40	0.75	0.90	1.00
	220~560	0.50	0.85	0.94	1.00
	680~1800	0.60	0.87	0.95	1.00
	2200~3900	0.75	0.90	0.95	1.00

PART NUMBER SYSTEM (EXAMPLE : 25V 220µF)

1	23	456	7	89	10	11 12	13 14
E	GK	227	M	1E	F	12	RR



STANDARD RATINGS

Voltage (Code)		6.3V (0J)			10V (1A)			16V (1C)		
Cap. (µF)	Code	Case Size	Impedance	Ripple Current	Case Size	Impedance	Ripple Current	Case Size	Impedance	Ripple Current
120	127							6.3 x 11	0.130	405
220	227	6.3 x 11	0.130	405	6.3 x 11	0.130	405	8 x 12	0.072	760
330	337	6.3 x 11	0.130	405	8 x 12	0.072	760	8 x 12	0.072	760
470	477	8 x 12	0.072	760	8 x 12	0.072	760	8 x 16	0.056	995
560	567	8 x 12	0.072	760				10 x 12.5	0.053	1030
680	687				8 x 16	0.056	995	8 x 20	0.041	1250
					10 x 12.5	0.053	1030	10 x 16	0.038	1430
820	827	8 x 16	0.056	995						
1000	108	10 x 12.5	0.053	1030	8 x 20	0.041	1250	10 x 20	0.023	1820
					10 x 16	0.038	1430			
1200	128	8 x 20	0.041	1250	10 x 20	0.023	1820	10 x 25	0.022	2150
		10 x 16	0.038	1430						
1500	158	10 x 20	0.023	1820	10 x 25	0.022	2150	12.5 X 20	0.021	2360
2200	228	10 x 25	0.022	2150	12.5 x 20	0.021	2360	12.5 X 25	0.018	2770
3300	338	12.5 x 20	0.021	2360	12.5 x 25	0.018	2770			
3900	398	12.5 x 25	0.018	2770						

Maximum Allowable Ripple Current (mArms) at 105°C 100kHz

Case Size Φ D x L (mm)

Maximum Impedance (Ω) at 20°C 100kHz

Voltage (Code)		25V (1E)		
Cap. (µF)	Code	Case Size	Impedance	Ripple Current
100	107	6.3 x 11	0.130	405
220	227	8 x 12	0.072	760
330	337	8 x 16	0.056	995
		10 x 12.5	0.053	1030
470	477	8 x 20	0.041	1250
		10 x 16	0.038	1430
680	687	10 x 20	0.023	1820
820	827	10 x 25	0.022	2150
1000	108	12.5 x 20	0.021	2360
1500	158	12.5 x 25	0.018	2770

Maximum Allowable Ripple Current (mArms) at 105°C 100kHz

Case Size Φ D x L (mm)

Maximum Impedance (Ω) at 20°C 100kHz

Specifications are subject to change without notice. Should a safety or technical concern arise regarding the product, please be sure to contact our sales offices or agents immediately.

FEATURES

- Load life of 5,000~6,000 hours at 105°C.
- Enabled high ripple current by a reduction of impedance at high frequency range.
- Lowest impedance for personal computer and storage equipment.



SPECIFICATIONS

Item	Performance Characteristics							
Operating Temperature Range	-40 to +105°C							
Rated Working Voltage Range	6.3 to 50V							
Nominal Capacitance Range	100 to 8200µF							
Capacitance Tolerance	±20% at 120Hz, +20°C							
Leakage Current	I ≤ 0.01CV or 3 (µA) whichever is greater measured after 2 minutes application of rated working voltage at +20°C							
tan δ (120Hz, +20°C)	Working Voltage (V)	6.3	10	16	25	35	50	
	tan δ (max.)	0.22	0.19	0.16	0.14	0.12	0.10	
For capacitance value >1000µF, add 0.02 per another 1000µF								
Low Temperature Characteristics	Impedance ratio max. at 120Hz							
	Working Voltage (V)	6.3	10	16	25	35	50	
Z-25°C / Z+20°C								
High Temperature Loading	Test time	ΦD	6.3	8~16	Post test requirements at +20°C			
	Load life		5,000h	6,000h	Leakage current : ≤Initial specified value			
	Test temperature	: +105°C				Cap. change : within ±25% of the initial measured value (6.3, 10V: within ±30%)		
	Test conditions	: Rated DC working voltage with rated ripple current				tan δ : ≤200% of the initial specified value		
Shelf Life	At +105°C no voltage applied after 1,000 hours and then being stabilized at +20°C the capacitors shall meet the following limits							
	Leakage current : ≤Initial specified value							
	Cap. change : within ±25% of the initial measured value (6.3, 10V: within ±30%)							
	tan δ : ≤200% of the initial specified value							
Industrial Standard	JIS C - 5101-4 (IEC 60384-4)							

CASE SIZE TABLE



ΦD	6.3	8 (L < 20)	8 (L ≥ 20)	10	12.5	16
F	2.5	3.5	3.5	5.0	5.0	7.5
Φd	0.5	0.5	0.6	0.6	0.6	0.8
α	(L < 20) 1.5			(L ≥ 20) 2.0		
β	(D < 20) 0.5			(D ≥ 20) 1.0		

RIPPLE CURRENT MULTIPLIER

Frequency Coefficient

Coefficient	Freq. (Hz)			
	120	1k	10k	100k
Cap (µF)				
100~180	0.40	0.75	0.90	1.00
220~560	0.50	0.85	0.94	1.00
680~1800	0.60	0.87	0.95	1.00
2200~3900	0.75	0.90	0.95	1.00
4700~8200	0.85	0.95	0.98	1.00

PART NUMBER SYSTEM (EXAMPLE : 16V 1000µF)

1	23	456	7	89	10	1112	1314
E	SH	108	M	1C	G	16	RR

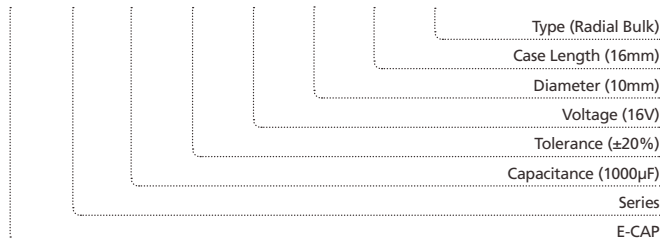

STANDARD RATINGS

Voltage (Code)		6.3V (0J)			10V (1A)			16V (1C)		
Cap. (µF)	Code	Case Size	Impedance	Ripple Current	Case Size	Impedance	Ripple Current	Case Size	Impedance	Ripple Current
220	227							6.3 x 11	0.110	500
330	337				6.3 x 11	0.110	500			
470	477	6.3 x 11	0.110	500				8 x 12	0.062	900
680	687				8 x 12	0.062	900	8 x 16	0.048	1210
								10 x 12.5	0.045	1240
820	827	8 x 12	0.062	900						
1000	108				8 x 16	0.048	1210	8 x 20	0.033	1410
					10 x 12.5	0.045	1240	10 x 16	0.032	1650
1200	128	8 x 16	0.048	1210						
		10 x 12.5	0.045	1240						
1500	158	8 x 20	0.033	1410	8 x 20	0.033	1410	10 x 20	0.020	1960
					10 x 16	0.032	1650			
						0.032	1760*		0.028	2500*
1800	188	10 x 16	0.032	1650	10 x 20	0.020	1960	10 x 25	0.018	2250
2200	228	10 x 20	0.020	1960	10 x 25	0.018	2250	12.5 x 20	0.017	2480
2700	278	10 x 25	0.018	2250				12.5 x 25	0.015	2900
3300	338				12.5 x 20	0.017	2480	12.5 x 30	0.013	3450
								16 x 20	0.015	3250
3900	398	12.5 x 20	0.017	2480	12.5 x 25	0.015	2900	12.5 x 35	0.012	3570
4700	478	12.5 x 25	0.015	2900	12.5 x 30	0.013	3450			
					16 x 20	0.015	3250	16 x 25	0.013	3630
5600	568	12.5 x 30	0.013	3450	12.5 x 35	0.012	3570			
6800	688	12.5 x 35	0.012	3570						
		16 x 20	0.015	3250	16 x 25	0.013	3630			
8200	828	16 x 25	0.013	3630						

Maximum Allowable Ripple Current (mArms) at 105°C 100kHz

Case Size Φ D x L (mm)

Maximum Impedance (Ω) at 20°C 100kHz

Voltage (Code)		25V (1E)			35V (1V)			50V (1H)		
Cap. (µF)	Code	Case Size	Impedance	Ripple Current	Case Size	Impedance	Ripple Current	Case Size	Impedance	Ripple Current
100	107	6.3 x 11	0.110	500	6.3 x 11	0.110	500	8 x 12	0.074	724
150	157	6.3 x 11	0.110	500				10 x 12.5	0.061	979
220	227				8 x 12	0.062	900	10 x 16	0.042	1370
330	337	8 x 12	0.062	900	10 x 12.5	0.045	1240	10 x 20	0.028	1870
390	397	8 x 16	0.048	1210	8 x 20	0.033	1410			
470	477	10 x 12.5	0.045	1240	10 x 16	0.032	1650	12.5 x 20	0.027	2050
560	567	8 x 20	0.033	1410	10 x 20	0.020	1960	12.5 x 25	0.023	2410
680	687	10 x 16	0.032	1650	10 x 20	0.020	1960	12.5 x 30	0.021	2860
			0.032	1760*						
820	827	10 x 20	0.020	1960*						
1000	108	10 x 25	0.018	2250	12.5 x 20	0.017	2480	16 x 25	0.021	3010
1200	128				12.5 x 25	0.015	2900			
1500	158	12.5 x 20	0.017	2480						
1800	188	12.5 x 25	0.015	2900						
2200	228	12.5 x 30	0.013	3450	16 x 25	0.013	3630			
		16 x 20	0.015	3250						
2700	278	12.5 x 35	0.012	3570						
3300	338	16 x 25	0.013	3630						

Maximum Allowable Ripple Current (mArms) at 105°C 100kHz

Case Size Φ D x L (mm)

Maximum Impedance (Ω) at 20°C 100kHz

* Special item with higher ripple current & longer life of 10,000 hrs.

Specifications are subject to change without notice. Should a safety or technical concern arise regarding the product, please be sure to contact our sales offices or agents immediately.

+105°C, Highest Ripple Current (更高紋波), Longest Life Assurance (更長壽命), Lower Impedance (較低阻抗)

FEATURES

- Higher ripple current than GT series and Lower Impedance than GY series.
- Load life of 6,000~10,000 hours at 105°C.
- Enabled high ripple current by a reduction of impedance at high frequency range.
- Lowest impedance for personal computer and storage equipment.



SPECIFICATIONS

Item	Performance Characteristics										
Operating Temperature Range	-40 to +105°C										
Rated Working Voltage Range	6.3 to 100V										
Nominal Capacitance Range	33 to 8200µF										
Capacitance Tolerance	±20% at 120Hz, +20°C										
Leakage Current	I ≤ 0.01CV or 3(µA) whichever is greater measured after 2 minutes application of rated working voltage at +20°C										
tan δ (120Hz, +20°C)	Working Voltage (V)	6.3	10	16	25	35	50	63	80	100	
	tan δ (max.)	0.22	0.19	0.16	0.14	0.12	0.10	0.09	0.08	0.08	
For capacitance > 1000µF, add 0.02 per another 1000µF											
Low Temperature Characteristics	Impedance ratio max. at 120Hz										
	Working Voltage (V)	6.3	10	16	25	35	50	63	80	100	
Z-25°C / Z+20°C		2	2	2	2	2	2	2	2	2	
High Temperature Loading	Test time	ΦD	6.3V	10-50V	63-100V	Post test requirements at +20°C					
		≤6.3	6,000h	7,000h	6,000h	Leakage current : ≤Initial specified value					
		8 x 12	8,000h	9,000h	8,000h	Cap. change : within ±25% of the initial measured value (6.3, 10V: within ±30%)					
		10 x 12.5	9,000h	9,000h	9,000h	tan δ : ≤200% of the initial specified value					
		8 x 16, 8 x 20	9,000h	10,000h	9,000h						
	10 x 16, 10 x 20, 10 x 25, ≥12.5	10,000h									
Test temperature : +105°C											
Test conditions : Rated DC working voltage with rated ripple current											
Shelf Life	At +105°C no voltage applied after 1,000 hours and then being stabilized at +20°C the capacitors shall meet the following limits										
	Leakage current : ≤Initial specified value										
	Cap. change : within ±25% of the initial measured value (6.3, 10V: within ±30%)										
	tan δ : ≤200% of the initial specified value										
Industrial Standard	JIS C - 5101-4 (IEC 60384-4)										

CASE SIZE TABLE



ΦD	5	6.3	8(L<20)	8(L≥20)	10	12.5	16	18
F	2.0	2.5	3.5	3.5	5.0	5.0	7.5	7.5
Φd	0.5	0.5	0.5	0.6	0.6	0.6	0.8	0.8
α	(L < 20) 1.5				(L ≥ 20) 2.0			
β	(D < 20) 0.5				(D ≥ 20) 1.0			

RIPPLE CURRENT MULTIPLIER

Frequency Coefficient

Coefficient	Freq. (Hz)	120	1K	10K	100K
Cap (µF)	33~270	0.50	0.73	0.92	1.00
	330~680	0.55	0.77	0.94	1.00
	820~1800	0.60	0.80	0.96	1.00
	2200~8200	0.70	0.85	0.98	1.00

PART NUMBER SYSTEM (EXAMPLE : 16V 1000µF)

1	2 3	4 5 6	7	8 9	10	11 12	13 14
E	SK	108	M	1C	G	16	RR



STANDARD RATINGS

Voltage (Code)		6.3V (0J)			10V (1A)			16V (1C)		
Cap. (µF)	Code	Case Size	Impedance	Ripple Current	Case Size	Impedance	Ripple Current	Case Size	Impedance	Ripple Current
270	277							6.3 x 12	0.170	700
330	337				6.3 x 12	0.170	700			
470	477	6.3 x 12	0.170	540				8 x 12	0.075	1200
560	567				8 x 12	0.075	1200	8 x 16	0.059	1600
680	687				8 x 16	0.059	1600	10 x 12.5	0.053	1700
820	827	8 x 12	0.075	945	10 x 12.5	0.053	1700	8 x 20	0.041	1960
1000	108	8 x 16	0.059	1250	8 x 20	0.041	1960	10 x 16	0.038	2000
1200	128	10 x 12.5	0.053	1330	10 x 16	0.038	2000			
1500	158	8 x 20	0.041	1500				10 x 20	0.028	2500
1800	188	10 x 16	0.038	1760	10 x 20	0.028	2500	10 x 25	0.024	2900
2200	228				10 x 25	0.024	2900	12.5 x 20	0.025	2600
2700	278	10 x 20	0.028	1960	12.5 x 20	0.025	2600	12.5 x 25	0.019	3200
3300	338	10 x 25	0.024	2250	12.5 x 25	0.019	3200	12.5 x 30	0.018	3660
								16 x 20	0.021	3330
3900	398	12.5 x 20	0.025	2480				12.5 x 35	0.016	4120
4700	478	12.5 x 25	0.019	2900	12.5 x 30	0.018	3660	16 x 25	0.017	3810
					16 x 20	0.021	3330			
5600	568	12.5 x 30	0.018	3450	12.5 x 35	0.016	4120			
					16 x 25	0.017	3810			
6800	688	16 x 20	0.021	3250						
		12.5 x 35	0.016	3570						
8200	828	16 x 25	0.017	3630						

Maximum Allowable Ripple Current (mArms) at 105°C 100kHz

Case Size Φ D x L (mm)

Maximum Impedance (Ω) at 20°C 100kHz



STANDARD RATINGS

Voltage (Code)		25V (1E)			35V (1V)			50V (1H)		
Cap. (µF)	Code	Case Size	Impedance	Ripple Current	Case Size	Impedance	Ripple Current	Case Size	Impedance	Ripple Current
56	566							6.3 x 12	0.220	500
100	107				6.3 x 12	0.170	700	8 x 12	0.120	950
120	127							8 x 16	0.082	1230
150	157	6.3 x 12	0.170	700				10 x 12.5	0.073	1280
180	187				8 x 12	0.075	1200	8 x 20	0.058	1580
220	227				8 x 16	0.059	1600	10 x 16	0.053	1650
270	277				10 x 12.5	0.053	1700			
330	337	8 x 12	0.075	1200	8 x 20	0.041	1960	10 x 20	0.038	2060
390	397	8 x 16	0.059	1600	10 x 16	0.038	2000	10 x 25	0.032	2420
470	477	10 x 12.5	0.053	1700				12.5 x 20	0.032	2300
560	567	8 x 20	0.041	1960	10 x 20	0.028	2500			
680	687	10 x 16	0.038	2000	10 x 25	0.024	2900	12.5 x 25	0.025	2800
820	827				12.5 x 20	0.025	2600	12.5 x 30	0.023	3370
								16 x 20	0.026	3070
1000	108	10 x 20	0.028	2500				12.5 x 35	0.021	3810
								16 x 25	0.022	3510
1200	128	10 x 25	0.024	2900	12.5 x 25	0.019	3200			
1500	158	12.5 x 20	0.025	2600	12.5 x 30	0.018	3660			
					16 x 20	0.021	3330			
1800	188	12.5 x 25	0.019	3200	12.5 x 35	0.016	4120			
					16 x 25	0.017	3810			
2200	228	16 x 20	0.021	3330						
		12.5 x 30	0.018	3660						
2700	278	12.5 x 35	0.016	4120						
3300	338	16 x 25	0.017	3810						

Maximum Allowable Ripple Current (mArms) at 105°C 100kHz

Case Size ΦD x L (mm)

Maximum Impedance (Ω) at 20°C 100kHz

Specifications are subject to change without notice. Should a safety or technical concern arise regarding the product, please be sure to contact our sales offices or agents immediately.

STANDARD RATINGS

Voltage (Code)		63V (1J)			80V (1K)			100V (2A)		
Cap. (µF)	Code	Case Size	Impedance	Ripple Current	Case Size	Impedance	Ripple Current	Case Size	Impedance	Ripple Current
33	336							8 x 12	0.290	620
47	476				8 x 12	0.290	620	8 x 16	0.200	780
56	566				8 x 16	0.200	780	10 x 12.5	0.170	780
68	686				10 x 12.5	0.170	780	8 x 20	0.160	1040
82	826	8 x 12	0.180	720	8 x 20	0.160	1040	10 x 16	0.110	1040
100	107	8 x 16	0.130	990	10 x 16	0.110	1040	10 x 20	0.084	1430
								12.5 x 16	0.110	1430
120	127	10 x 12.5	0.110	990				10 x 25	0.069	1620
150	157	8 x 20	0.096	1200	10 x 20	0.084	1430	12.5 x 20	0.062	1750
					12.5 x 16	0.110	1430			
180	187	10 x 16	0.076	1200	10 x 25	0.069	1620			
220	227				12.5 x 20	0.062	1750	12.5 x 25	0.047	2210
270	277	10 x 20	0.056	1570	12.5 x 25	0.047	2210	12.5 x 30	0.042	2400
		12.5 x 16	0.072	1570				16 x 20	0.048	1950
330	337	10 x 25	0.046	1990	12.5 x 30	0.042	2400	12.5 x 35	0.036	2600
					16 x 20	0.048	1950			
390	397	12.5 x 20	0.041	1990	12.5 x 35	0.036	2600	12.5 x 40	0.032	2860
								16 x 25	0.038	2430
								18 x 20	0.045	2270
470	477	12.5 x 25	0.031	2460	12.5 x 40	0.032	2860	16 x 31.5	0.032	2640
					16 x 25	0.038	2430			
					18 x 20	0.045	2270	18 x 25	0.036	2500
560	567	12.5 x 30	0.028	2760	16 x 31.5	0.032	2640	16 x 35.5	0.029	2860
		16 x 20	0.032	2380				18 x 31.5	0.030	2860
680	687	12.5 x 35	0.024	3040	16 x 35.5	0.029	2860	16 x 40	0.027	3510
					18 x 25	0.036	2500	18 x 35.5	0.027	3510
820	827	16 x 25	0.025	2890	16 x 40	0.027	3510	18 x 40	0.026	3860
					18 x 31.5	0.030	2860			
1000	108				18 x 35.5	0.027	3510			
1200	128				18 x 40	0.026	3860			

Maximum Allowable Ripple Current (mArms) at 105°C 100kHz

Case Size $\Phi D \times L$ (mm)

Maximum Impedance (Ω) at 20°C 100kHz

Specifications are subject to change without notice. Should a safety or technical concern arise regarding the product, please be sure to contact our sales offices or agents immediately.

+105°C, High Ripple Current (高紋波), Longer Life Assurance (較長壽命), Low Impedance (低阻抗品)

FEATURES

- Load life 105°C and low ESR.
- Excellent ripple current capability.
- Used in communication equipments, switching power supply, industrial measuring instruments, etc.

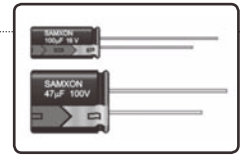

SPECIFICATIONS

Item	Performance Characteristics
Operating Temperature Range	-40 to +105°C
Rated Working Voltage Range	6.3 to 100V
Nominal Capacitance Range	15 to 4700µF
Capacitance Tolerance	±20% at 120Hz, +20°C
Leakage Current	I ≤ 0.01CV or 3 (µA) whichever is greater measured after 2 minutes application of rated working voltage at +20°C
tan δ (120Hz, +20°C)	Working Voltage (V)
	tan δ (max.)
Low Temperature Characteristics	Impedance ratio max. at 120Hz
	Working Voltage (V)
	Z-25°C / Z+20°C
High Temperature Loading	Test time
	Test temperature
Shelf Life	At +105°C no voltage applied after 1,000 hours and then being stabilized at +20°C the capacitors shall meet the following limits
	Leakage current
Industrial Standard	JIS C - 5101-4 (IEC 60384-4)

CASE SIZE TABLE



φD	6.3	8 (L < 20)	8 (L ≥ 20)	10	12.5
F	2.5	3.5	3.5	5.0	5.0
φd	0.5	0.5	0.6	0.6	0.6
α		(L < 20) 1.5		(L ≥ 20) 2.0	
β		(D < 20) 0.5		(D ≥ 20) 1.0	

PART NUMBER SYSTEM (EXAMPLE : 35V 2200µF)



STANDARD RATINGS

Voltage (Code)		6.3V (0J)			10V (1A)			16V (1C)		
Cap. (µF)	Code	Case Size	Impedance	Ripple Current	Case Size	Impedance	Ripple Current	Case Size	Impedance	Ripple Current
100	107							6.3 x 11	0.286	298
120	127							6.3 x 11	0.286	298
150	157				6.3 x 11	0.286	298	6.3 x 11	0.286	298
								8 x 12	0.169	561
180	187				6.3 x 11	0.286	298	6.3 x 11	0.286	298
								8 x 12	0.169	561
220	227	6.3 x 11	0.286	298	6.3 x 11	0.286	298	6.3 x 11	0.286	298
								8 x 12	0.169	561
270	227	6.3 x 11	0.286	298	6.3 x 11	0.286	298	8 x 12	0.169	561
					8 x 12	0.169	561			
330	337	6.3 x 11	0.286	298	6.3 x 11	0.286	298	8 x 12	0.169	561
		8 x 12	0.169	561	8 x 12	0.169	561			
390	397	8 x 12	0.169	561	8 x 12	0.169	561	8 x 12	0.169	561
470	477	8 x 12	0.169	561	8 x 12	0.169	561	8 x 12	0.169	561
								10 x 12.5	0.104	759
560	567	8 x 12	0.169	561	8 x 12	0.169	561	10 x 12.5	0.104	759
680	687	8 x 12	0.169	561	8 x 12	0.169	561	8 x 16	0.113	737
								10 x 12.5	0.104	759
820	827	8 x 12	0.169	561	10 x 12.5	0.104	759	10 x 16	0.078	1061
		10 x 12.5	0.104	759						
1000	108	8 x 12	0.169	561	8 x 16	0.113	737	10 x 16	0.078	1061
		10 x 12.5	0.104	759	10 x 16	0.078	1061			
1200	128	8 x 16	0.113	737	10 x 20	0.060	1228	10 x 20	0.060	1228
		10 x 12.5	0.104	759						
1500	158	8 x 20	0.090	921	10 x 20	0.060	1228	10 x 20	0.060	1228
		10 x 16	0.078	1061						
1800	188	10 x 20	0.060	1228	10 x 20	0.060	1228	10 x 25	0.055	1447
								12.5 x 20	0.046	1666
2200	228	10 x 20	0.060	1228	10 x 20	0.060	1228	12.5 x 20	0.046	1666
2700	278	10 x 25	0.055	1447	10 x 25	0.055	1447	12.5 x 25	0.039	1863
		12.5 x 20	0.046	1666	12.5 x 20	0.046	1666			
3300	338	10 x 25	0.055	1447	12.5 x 25	0.039	1863			
		12.5 x 20	0.046	1666						
3900	398	12.5 x 20	0.046	1666						
4700	478	12.5 x 25	0.039	1863						

Maximum Allowable Ripple Current (mArms) at 105°C 100kHz

Case Size Φ D x L (mm)

Maximum Impedance (Ω) at 20°C 100kHz

Specifications are subject to change without notice. Should a safety or technical concern arise regarding the product, please be sure to contact our sales offices or agents immediately.



STANDARD RATINGS

Voltage (Code)		25V (1E)			35V (1V)			50V (1H)		
Cap. (μF)	Code	Case Size	Impedance	Ripple Current	Case Size	Impedance	Ripple Current	Case Size	Impedance	Ripple Current
33	336							6.3 x 11	0.390	259
39	396							6.3 x 11	0.390	259
47	476				6.3 x 11	0.286	298	6.3 x 11	0.390	259
56	566				6.3 x 11	0.286	298	8 x 12	0.221	487
68	686				6.3 x 11	0.286	298	8 x 12	0.221	487
82	826	6.3 x 11	0.286	298	8 x 12	0.169	561	8 x 12	0.221	487
100	107	6.3 x 11	0.286	298	8 x 12	0.169	561	10 x 12.5	0.156	667
120	127	8 x 12	0.169	561	8 x 12	0.169	561	8 x 16	0.156	640
150	157	8 x 12	0.169	561	8 x 12	0.169	561	10 x 12.5	0.156	667
180	187	8 x 12	0.169	561	8 x 12	0.169	561	10 x 16	0.109	921
220	227	8 x 12	0.169	561	10 x 12.5	0.104	759	8 x 20	0.118	798
270	277	8 x 12	0.169	561	10 x 12.5	0.104	759	10 x 16	0.109	921
330	337	8 x 12	0.169	561	8 x 16	0.113	737	10 x 16	0.109	921
390	397	10 x 12.5	0.104	759	10 x 12.5	0.104	759	10 x 16	0.104	759
470	477	10 x 12.5	0.104	759	10 x 16	0.078	1061	10 x 25	0.072	1263
560	567	8 x 12	0.169	561	8 x 20	0.090	921	12.5 x 20	0.059	1456
680	687	10 x 12.5	0.104	759	10 x 16	0.078	1061	10 x 16	0.078	1061
820	827	10 x 12.5	0.104	759	10 x 16	0.078	1061	12.5 x 20	0.059	1456
1000	108	8 x 16	0.113	737	10 x 16	0.078	1061	12.5 x 25	0.050	1620
1200	128	10 x 12.5	0.104	759	10 x 16	0.078	1061	10 x 16	0.078	1061
1500	158	10 x 16	0.078	1061	10 x 20	0.060	1228	12.5 x 25	0.050	1620
1800	188	10 x 16	0.078	1061	10 x 20	0.060	1228	10 x 20	0.060	1228
2200	228	10 x 20	0.060	1228	10 x 25	0.055	1447	10 x 25	0.055	1447
		12.5 x 20	0.046	1666	12.5 x 20	0.046	1666	12.5 x 20	0.046	1666
		10 x 20	0.060	1228	12.5 x 25	0.039	1863	12.5 x 25	0.039	1863
		10 x 20	0.060	1228						
		10 x 25	0.055	1447						
		12.5 x 20	0.046	1666						
		12.5 x 25	0.039	1863						
		12.5 x 25	0.039	1863						

Maximum Allowable Ripple Current (mArms) at 105°C 100kHz
Maximum Impedance (Ω) at 20°C 100kHz

Case Size ΦD x L (mm)

RS
Miniature Aluminum Electrolytic Capacitors

Specifications are subject to change without notice. Should a safety or technical concern arise regarding the product, please be sure to contact our sales offices or agents immediately.

STANDARD RATINGS

Voltage (Code)		63V (1J)			100V (2A)		
Cap. (µF)	Code	Case Size	Impedance	Ripple Current	Case Size	Impedance	Ripple Current
15	156				6.3 x 11	1.560	101
22	226	6.3 x 11	1.560	101			
27	276	6.3 x 11	1.560	101	8 x 12	0.819	203
33	336	6.3 x 11	1.560	101			
39	396	8 x 12	0.819	203	8 x 16	0.585	263
47	476	8 x 12	0.819	203	10 x 12.5	0.559	253
56	566	8 x 12	0.819	203	8 x 20	0.429	317
68	686	8 x 12	0.819	203	10 x 16	0.403	313
82	826	10 x 12.5	0.559	253	10 x 20	0.273	409
100	107	8 x 16	0.585	263	10 x 20	0.273	409
		10 x 12.5	0.559	253			
120	127	10 x 16	0.403	313	12.5 x 20	0.208	605
150	157	8 x 20	0.429	317			
180	187	10 x 20	0.273	409	12.5 x 25	0.156	688
220	227	10 x 20	0.273	409	12.5 x 25	0.156	688
270	277	12.5 x 20	0.208	605			
330	337	12.5 x 20	0.208	605			
390	397	12.5 x 25	0.156	688			

Maximum Allowable Ripple Current (mArms) at 105°C 100kHz

Case Size Φ D x L (mm)

Maximum Impedance (Ω) at 20°C 100kHz

RIPPLE CURRENT MULTIPLIER

Frequency Coefficient

Coefficient Cap (µF)	Freq. (Hz)			
	120	1k	10k	100k
≤180	0.40	0.75	0.90	1.00
220~560	0.50	0.85	0.94	1.00
680~1800	0.60	0.87	0.95	1.00
2200~3900	0.75	0.90	0.95	1.00
4700	0.85	0.95	0.98	1.00

Specifications are subject to change without notice. Should a safety or technical concern arise regarding the product, please be sure to contact our sales offices or agents immediately.

FEATURES

- Low impedance for high frequency.
- Load life of 4,000~10,000 hours at 105°C.



SPECIFICATIONS

Item	Performance Characteristics
Operating Temperature Range	-40 to +105°C
Rated Working Voltage Range	6.3 to 100V
Nominal Capacitance Range	3.3 to 15000µF
Capacitance Tolerance	±20% at 120Hz, +20°C
Leakage Current	I ≤ 0.01CV or 3 (µA) whichever is greater measured after 2 minutes application of rated working voltage at +20°C
tan δ (120Hz, +20°C)	Working Voltage (V)
	tan δ (max.)
Low Temperature Characteristics	Impedance ratio max. at 120Hz
	Rated Voltage (V)
	Z-25°C / Z+20°C
High Temperature Loading	Test time
	Test temperature
	Test conditions
	Post test requirements at +20°C
Shelf Life	At +105°C no voltage applied after 1,000 hours and then being stabilized at +20°C the capacitors shall meet the following limits
	Leakage current
	Cap. change
Industrial Standard	JIS C - 5101-4 (IEC 60384-4)

CASE SIZE TABLE



φD	6.3	8 (L < 20)	8 (L ≥ 20)	10	12.5	16	18
F	2.5	3.5	3.5	5.0	5.0	7.5	7.5
φd	0.5	0.5	0.6	0.6	0.6	0.8	0.8
α		(L < 20) 1.5			(L ≥ 20) 2.0		
β		(D < 20) 0.5			(D ≥ 20) 1.0		

RIPPLE CURRENT MULTIPLIER

Frequency Coefficient

Coefficient	120	1k	10k	100k
3.3~10	0.42	0.60	0.80	1.00
22~33	0.55	0.75	0.90	1.00
47~330	0.70	0.85	0.95	1.00
470~1000	0.75	0.90	0.98	1.00
2200~15000	0.80	0.95	1.00	1.00

PART NUMBER SYSTEM (EXAMPLE : 10V 1000µF)

1	23	456	7	89	10	11 12	13 14
E	GY	108	M	1A	G	16	RR

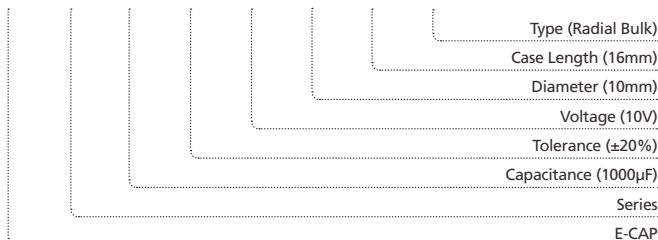

STANDARD RATINGS

Voltage (Code)		6.3V (0J)			10V (1A)			16V (1C)		
Cap. (µF)	Code	Case Size	Impedance	Ripple Current	Case Size	Impedance	Ripple Current	Case Size	Impedance	Ripple Current
47	476							5 x 11	0.900	150
100	107	5 x 11	0.900	150	5 x 11	0.900	150	6.3 x 11	0.400	250
220	227	6.3 x 11	0.400	250	6.3 x 11	0.400	250	8 x 12	0.250	400
330	337	6.3 x 11	0.400	250	8 x 12	0.250	400	8 x 12	0.250	400
470	477	8 x 12	0.250	400	8 x 12	0.250	400	10 x 12.5	0.160	580
1000	108	10 x 12.5	0.160	580	10 x 16	0.120	770	10 x 20	0.078	1050
2200	228	12.5 x 20	0.062	1300	12.5 x 20	0.062	1300	12.5 x 25	0.048	1650
3300	338	12.5 x 20	0.062	1300	12.5 x 25	0.048	1650	16 x 25	0.034	1850
4700	478	16 x 25	0.034	1850	16 x 25	0.034	1850	16 x 30	0.029	2000
6800	688	16 x 25	0.034	1850	16 x 30	0.029	2000	18 x 35	0.025	2200
10000	109	16 x 30	0.029	2000	18 x 35	0.025	2200			
15000	159	18 x 35	0.025	2200						

Maximum Allowable Ripple Current (mArms) at 105°C 100kHz

Case Size Φ D x L (mm)

Maximum Impedance (Ω) at 20°C 100kHz

Voltage (Code)		25V (1E)			35V (1V)			50V (1H)		
Cap. (µF)	Code	Case Size	Impedance	Ripple Current	Case Size	Impedance	Ripple Current	Case Size	Impedance	Ripple Current
3.3	335							5 x 11	2.200	53
4.7	475							5 x 11	1.900	88
10	106							5 x 11	1.500	100
22	226							5 x 11	0.900	150
33	336	5 x 11	0.900	150	5 x 11	0.900	150	6.3 x 11	0.400	250
47	476	5 x 11	0.900	150	6.3 x 11	0.400	250	6.3 x 11	0.400	250
100	107	6.3 x 11	0.400	250	8 x 12	0.250	400	8 x 12	0.250	400
220	227	8 x 12	0.250	400	10 x 12.5	0.160	580	10 x 16	0.120	770
330	337	8 x 12	0.250	400	10 x 16	0.120	770	10 x 20	0.078	1050
		10 x 12.5	0.160	580						
		10 x 16	0.120	770						
470	477	10 x 12.5	0.160	580	10 x 20	0.078	1050	12.5 x 20	0.062	1300
		10 x 16	0.120	770						
		10 x 20	0.078	1050						
1000	108	12.5 x 20	0.062	1300	12.5 x 25	0.048	1650	16 x 25	0.034	1850
		12.5 x 25	0.048	1650						
2200	228	16 x 25	0.034	1850	16 x 30	0.029	2000	18 x 35	0.025	2200
		16 x 30	0.029	2000						
3300	338	16 x 30	0.029	2000	18 x 35	0.025	2200			
4700	478	18 x 35	0.025	2200						

Maximum Allowable Ripple Current (mArms) at 105°C 100kHz

Case Size Φ D x L (mm)

Maximum Impedance (Ω) at 20°C 100kHz

Voltage (Code)		63V (1J)			100V (2A)		
Cap. (µF)	Code	Case Size	Impedance	Ripple Current	Case Size	Impedance	Ripple Current
22	226	6.3 x 11	1.300	140	8 x 12	0.630	160
33	336	6.3 x 11	1.200	140	10 x 12.5	0.430	230
47	476	8 x 12	0.630	210	10 x 16	0.310	290
100	107	10 x 12.5	0.430	300	10 x 16	0.310	290
					12.5 x 20	0.160	430
220	227	10 x 20	0.210	520	16 x 25	0.073	900
330	337	12.5 x 20	0.160	660	16 x 25	0.073	900
470	477	12.5 x 25	0.120	750			
1000	108	16 x 30	0.054	1390			

Maximum Allowable Ripple Current (mArms) at 105°C 100kHz

Case Size Φ D x L (mm)

Maximum Impedance (Ω) at 20°C 100kHz

Specifications are subject to change without notice. Should a safety or technical concern arise regarding the product, please be sure to contact our sales offices or agents immediately.

-55°C~+105°C, Wide Temperature (寬溫度), High Ripple Current (高紋波), Low Impedance (低阻抗品)

FEATURES

- Load life of 1,000~4,000 hours at 105°C
- Enabled high ripple current by a reduction of impedance at high frequency range.

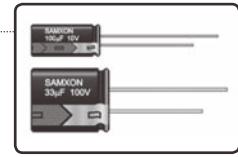

SPECIFICATIONS

Item	Performance Characteristics
Operating Temperature Range	-55 to +105°C
Rated Working Voltage Range	6.3 to 100V
Nominal Capacitance Range	22 to 4700µF
Capacitance Tolerance	±20% at 120Hz, +20°C
Leakage Current	I ≤ 0.01CV or 3 (µA) whichever is greater measured after 2 minutes application of rated working voltage at +20°C
tan δ (120Hz, +20°C)	Working Voltage (V)
	tan δ (max.)
Low Temperature Characteristics	Impedance ratio max. at 120 Hz
	Working Voltage (V)
	Z-25°C / Z+20°C
	Z-40°C / Z+20°C
High Temperature Loading	Test time
	Test temperature
	Test conditions
Shelf Life	At +105°C no voltage applied after 1,000 hours and then being stabilized at +20°C the capacitors shall meet the following limits
	Leakage current
	Cap. change
Industrial Standard	JIS C - 5101-4 (IEC 60384-4) EIAJ RC - 2372

CASE SIZE TABLE



φD	6.3	8(L <20)	8(L <20)	10	12.5
F	2.5	3.5	3.5	5.0	5.0
φd	0.5	0.5	0.6	0.6	0.6
α	(L <20) 1.5			(L ≥20) 2.0	
β	(D <20) 0.5			(D ≥20) 1.0	

RIPPLE CURRENT MULTIPLIER

Frequency Coefficient

Coefficient	60	120	1k	10k	100k
Cap (µF)					
22~330	0.55	0.75	0.85	0.90	1.00
390~1000	0.70	0.75	0.90	0.95	1.00
1200~2200	0.75	0.80	0.90	0.95	1.00
2700~4700	0.80	0.85	0.95	1.00	1.00

PART NUMBER SYSTEM (EXAMPLE : 16V 330µF)



STANDARD RATINGS

Voltage (Code)		6.3V (0J)			10V (1A)			16V (1C)		
Cap. (μF)	Code	Case Size	Impedance	Ripple Current	Case Size	Impedance	Ripple Current	Case Size	Impedance	Ripple Current
100	107							6.3 x 11	0.220	340
120	127							6.3 x 11	0.220	340
150	157				6.3 x 11	0.220	340	6.3 x 11	0.220	340
180	187	6.3 x 11	0.220	340	6.3 x 11	0.220	340	6.3 x 11	0.220	340
220	227	6.3 x 11	0.220	340	6.3 x 11	0.220	340	8 x 12	0.130	640
270	277	6.3 x 11	0.220	340	6.3 x 11	0.220	340	8 x 12	0.130	640
330	337	6.3 x 11	0.220	340	8 x 12	0.130	640	8 x 12	0.130	640
390	397	8 x 12	0.130	640	8 x 12	0.130	640	8 x 12	0.130	640
470	477	8 x 12	0.130	640	8 x 12	0.130	640	8 x 12	0.130	640
								10 x 12.5	0.080	865
560	567	8 x 12	0.130	640	8 x 12	0.130	640	10 x 12.5	0.080	865
680	687	8 x 12	0.130	640	8 x 12	0.130	640	8 x 16	0.087	840
								10 x 12.5	0.080	865
820	827	8 x 12	0.130	640	10 x 12.5	0.080	865	10 x 16	0.060	1210
		10 x 12.5	0.080	865						
1000	108	8 x 12	0.130	640	8 x 16	0.087	840	10 x 16	0.060	1210
		10 x 12.5	0.080	865	10 x 16	0.060	1210			
1200	128	8 x 16	0.087	840	10 x 20	0.046	1400	10 x 20	0.046	1400
		10 x 12.5	0.080	865						
1500	158	10 x 16	0.060	1210	10 x 20	0.046	1400	10 x 20	0.046	1400
1800	188	10 x 20	0.046	1400	10 x 20	0.046	1400	12.5 x 20	0.035	1900
2200	228	10 x 20	0.046	1400	10 x 20	0.046	1400	12.5 x 20	0.035	1900
		10 x 25	0.042	1650						
2700	278	12.5 x 20	0.035	1900	12.5 x 20	0.035	1900	12.5 x 25	0.030	2124
		10 x 25	0.042	1650						
3300	338	12.5 x 20	0.035	1900	12.5 x 25	0.030	2124			
		10 x 25	0.042	1650						
3900	398	12.5 x 20	0.035	1900						
4700	478	12.5 x 25	0.030	2124						

Maximum Allowable Ripple Current (mArms) at 105°C 100kHz

Case Size ΦD x L (mm)

Maximum Impedance (Ω) at 20°C 100kHz

Specifications are subject to change without notice. Should a safety or technical concern arise regarding the product, please be sure to contact our sales offices or agents immediately.



STANDARD RATINGS

Voltage (Code)		25V (1E)			35V (1V)			50V (1H)		
Cap. (μF)	Code	Case Size	Impedance	Ripple Current	Case Size	Impedance	Ripple Current	Case Size	Impedance	Ripple Current
33	336							6.3 x 11	0.300	295
39	396							6.3 x 11	0.300	295
47	476				6.3 x 11	0.220	340	6.3 x 11	0.300	295
56	566				6.3 x 11	0.220	340	8 x 12	0.170	555
68	686				6.3 x 11	0.220	340	8 x 12	0.170	555
82	826	6.3 x 11	0.220	340	8 x 12	0.130	640	8 x 12	0.170	555
100	107	6.3 x 11	0.220	340	8 x 12	0.130	640	10 x 12.5	0.120	760
120	127	8 x 12	0.130	640	8 x 12	0.130	640	8 x 16	0.120	730
150	157	8 x 12	0.130	640	8 x 12	0.130	640	10 x 12.5	0.120	760
180	187	8 x 12	0.130	640	8 x 12	0.130	640	10 x 16	0.084	1050
220	227	8 x 12	0.130	640	10 x 12.5	0.080	865	8 x 20	0.091	910
270	277	8 x 12	0.130	640	10 x 12.5	0.080	865	10 x 16	0.084	1050
330	337	10 x 12.5	0.080	865	8 x 16	0.087	840	10 x 16	0.084	1050
390	397	8 x 12	0.130	640	10 x 12.5	0.080	865	10 x 25	0.055	1440
470	477	10 x 12.5	0.080	865	8 x 20	0.069	1050	12.5 x 20	0.045	1660
560	567	10 x 12.5	0.080	865	10 x 16	0.060	1210	10 x 16	0.060	1210
680	687	8 x 16	0.087	840	10 x 16	0.060	1210	12.5 x 20	0.045	1660
820	827	10 x 12.5	0.080	865	10 x 16	0.060	1210	12.5 x 25	0.034	1950
1000	108	10 x 16	0.060	1210	10 x 20	0.046	1400	12.5 x 25	0.034	1950
1200	128	10 x 16	0.060	1210	10 x 20	0.046	1400			
1500	158	10 x 20	0.046	1400	12.5 x 20	0.035	1900			
1800	188	10 x 20	0.046	1400	12.5 x 25	0.030	2124			
2200	228	10 x 20	0.046	1400						
		10 x 25	0.042	1650						
		12.5 x 20	0.035	1900						
		12.5 x 25	0.030	2124						
		12.5 x 25	0.030	2124						

Maximum Allowable Ripple Current (mArms) at 105°C 100kHz

Case Size ΦD x L (mm)

Maximum Impedance (Ω) at 20°C 100kHz

RF

Miniature Aluminum Electrolytic Capacitors

Specifications are subject to change without notice. Should a safety or technical concern arise regarding the product, please be sure to contact our sales offices or agents immediately.

STANDARD RATINGS

Voltage (Code)		63V (1J)			100V (2A)		
Cap. (μF)	Code	Case Size	Impedance	Ripple Current	Case Size	Impedance	Ripple Current
22	226	6.3 x 11	0.960	115			
33	336	6.3 x 11	0.960	115			
39	396	8 x 12	0.504	232	8 x 16	0.360	300
47	476	8 x 12	0.504	232	10 x 12.5	0.344	314
56	566	8 x 12	0.504	232	8 x 20	0.264	362
68	686	8 x 12	0.504	232	10 x 16	0.248	357
82	826	10 x 12.5	0.344	314	10 x 20	0.168	466
100	107	8 x 16	0.360	300	10 x 20	0.168	466
		10 x 12.5	0.344	314			
120	127	10 x 16	0.248	357	12.5 x 20	0.128	690
150	157	8 x 20	0.264	362			
180	187	10 x 20	0.168	466	12.5 x 25	0.096	922
220	227	10 x 20	0.168	466	12.5 x 25	0.096	922
270	277	12.5 x 20	0.128	690			
330	337	12.5 x 20	0.128	690			
390	397	12.5 x 25	0.096	922			

Maximum Allowable Ripple Current (mArms) at 105°C 100kHz

Case Size ΦD x L (mm)

Maximum Impedance (Ω) at 20°C 100kHz

Specifications are subject to change without notice. Should a safety or technical concern arise regarding the product, please be sure to contact our sales offices or agents immediately.

FEATURES

- High ripple current.
- For electronic ballast, power supply.



SPECIFICATIONS

Item	Performance Characteristics						
Operating Temperature Range	-40 to +105°C			-25 to +105°C			
Rated Working Voltage Range	160 to 400V			450V			
Nominal Capacitance Range	1 to 220µF						
Capacitance Tolerance	±20% at 120Hz, +20°C						
Leakage Current	I ≤ 0.02CV + 25 (µA) after 2 minutes application of rated working voltage at +20°C						
tan δ (120Hz, +20°C)	Working Voltage (V)	160	200	250	350	400	450
	tan δ (max.)	0.15	0.15	0.15	0.20	0.20	0.20
Surge Voltage	Working Voltage (V)	160	200	250	350	400	450
	Surge Voltage (V)	200	250	300	400	450	500
Low Temperature Characteristics	Impedance ratio max. at 120Hz						
	Working Voltage (V)	160	200	250	350	400	450
	Z-25°C / Z+20°C	3	3	3	5	5	6
High Temperature Loading	Test time	: 3,000 hours			Post test requirements at +20°C		
	Test temperature	: +105°C			Leakage current : ≤ Initial specified value		
	Test conditions	: Rated DC working voltage with rated ripple current			Cap. change : within ±20% of the initial measured value		
					tan δ : ≤ 200% of the initial specified value		
Shelf Life	At +105°C no voltage applied after 1,000 hours and then being stabilized at +20°C the capacitors shall meet the following limits						
	Leakage current	: ≤ Initial specified value					
	Cap. change	: within ±20% of the initial measured value					
	tan δ	: ≤ 200% of the initial specified value					
Industrial Standard	JIS C - 5101-4 (IEC 60384-4)						

CASE SIZE TABLE



φD	8 (L < 20)	8 (L ≥ 20)	10	12.5	16	18
F	3.5	3.5	5.0	5.0	7.5	7.5
φd	0.5	0.6	0.6	0.6	0.8	0.8
α	(L < 20) 1.5			(L ≥ 20) 2.0		
β	(D < 20) 0.5			(D ≥ 20) 1.0		

RIPPLE CURRENT MULTIPLIER

Frequency Coefficient

Coefficient Cap (µF)	120	1k	10k	100k
1~5.6	0.20	0.40	0.80	1.00
6.8~180	0.40	0.75	0.90	1.00
≥ 220	0.50	0.85	0.94	1.00

PART NUMBER SYSTEM (EXAMPLE : 200V 220µF)

1	23	456	7	89	10	11 12	13 14
E	RR	227	M	2D	L	30	RR



STANDARD RATINGS

Voltage (Code)		160V (2C)		200V (2D)		250V (2E)		350V (2V)	
Cap. (µF)	Code	Case Size	Ripple Current	Case Size	Ripple Current	Case Size	Ripple Current	Case Size	Ripple Current
4.7	475					8 x 12	160	10 x 12.5	150
5.6	565							10 x 12.5	180
6.8	685			8 x 12	204	8 x 12 10 x 12.5	215 250	10 x 16	280
10	106	10 x 16	320	10 x 16	320	10 x 16	320	10 x 20	350
22	226	10 x 20	500	10 x 16 10 x 20	453 500	10 x 16 10 x 20	453 500	12.5 x 20	650
33	336	10 x 20	650	10 x 16 10 x 20	589 650	10 x 16 12.5 x 20	640 800	16 x 20	900
47	476	10 x 20	750	12.5 x 20	980	12.5 x 20	980	16 x 20	1080
68	686	12.5 x 20	1180	12.5 x 25 16 x 20	1300 1300	16 x 20	1300	18 x 25	1470
82	826			16 x 20	1380	16 x 20	1380	18 x 25	1530
100	107	12.5 x 25 16 x 20	1420 1420	16 x 20	1420	16 x 25	1530		
150	157	16 x 25	1890	16 x 25	1890	18 x 25	1940		
220	227	18 x 25	2370	18 x 30	2648				

Maximum Allowable Ripple Current (mArms) at 105°C 100kHz

Case Size Φ D x L (mm)

Voltage (Code)		400V (2G)		450V (2W)	
Cap. (µF)	Code	Case Size	Ripple Current	Case Size	Ripple Current
1	105	8 x 12	60		
1.5	155	8 x 12	90		
		10 x 12.5	100		
1.8	185	8 x 12	95		
		10 x 12.5	120		
2.2	225	8 x 12	95	8 x 12	105
		10 x 12.5	140		
3.3	335	8 x 12	130		
		10 x 12.5	150		
4.7	475	8 x 12	171	8 x 16	176
		10 x 16	220	10 x 20	220
5.6	565	10 x 16	250	10 x 20	250
				10 x 12.5	228
6.8	685	10 x 16	280	10 x 20	280
				10 x 20	397
10	106	10 x 16	317	10 x 20	397
		10 x 20	350	12.5 x 20	450
15	156	12.5 x 15	487		
		12.5 x 20	550	12.5 x 25	600
22	226	12.5 x 20	760	12.5 x 25	698
				16 x 20	730
33	336	12.5 x 25	861	16 x 20	891
		16 x 20	900	16 x 25	980
47	476	12.5 x 25	1027	16 x 25	1121
		16 x 20	1073	18 x 20	1093
68	686	16 x 25	1180	18 x 25	1200
		18 x 20	1180		
68	686	16 x 25	1374		
		16 x 30	1488		
		18 x 25	1470		

Maximum Allowable Ripple Current (mArms) at 105°C 100kHz

Case Size Φ D x L (mm)

Specifications are subject to change without notice. Should a safety or technical concern arise regarding the product, please be sure to contact our sales offices or agents immediately.

FEATURES

- High ripple current & load life 5,000 hours.
- For electronic ballast, power supply.



SPECIFICATIONS

Item	Performance Characteristics						
Operating Temperature Range	-40 to +105°C			-25 to +105°C			
Rated Working Voltage Range	160 to 400V			450V			
Nominal Capacitance Range	1 to 220µF						
Capacitance Tolerance	±20% at 120Hz, +20°C						
Leakage Current	I ≤ 0.02CV + 25 (µA) after 2 minutes application of rated working voltage at +20°C						
tan δ (120Hz, +20°C)	Working Voltage (V)	160	200	250	350	400	450
	tan δ (max.)	0.15	0.15	0.15	0.20	0.20	0.20
Low Temperature Characteristics	Impedance ratio max. at 120Hz						
	Working Voltage (V)	160	200	250	350	400	450
	Z-25°C / Z+20°C	3	3	3	5	5	6
High Temperature Loading	Test time	: 5,000 hours			Post test requirements at +20°C		
	Test temperature	: +105°C			Leakage current : ≤ Initial specified value		
	Test conditions	: Rated DC working voltage with rated ripple current			Cap. change : within ±20% of the initial measured value		
					tan δ : ≤ 200% of the initial specified value		
Shelf Life	At +105°C no voltage applied after 1,000 hours and then being stabilized at +20°C the capacitors shall meet the following limits						
	Leakage current	: ≤ Initial specified value					
	Cap. change	: within ±20% of the initial measured value					
	tan δ	: ≤ 200% of the initial specified value					
Industrial Standard	JIS C - 5101-4 (IEC 60384-4)						

CASE SIZE TABLE

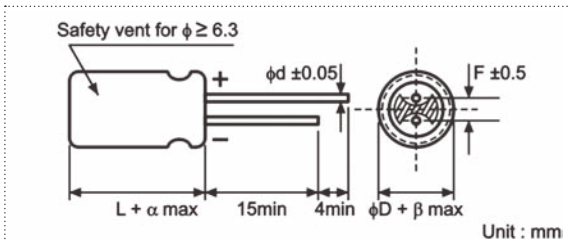

	8 (L < 20)	8 (L ≥ 20)	10	12.5	16	18
Φ D	8 (L < 20)	8 (L ≥ 20)	10	12.5	16	18
F	3.5	3.5	5.0	5.0	7.5	7.5
Φ d	0.5	0.6	0.6	0.6	0.8	0.8
α	(L < 20) 1.5			(L ≥ 20) 2.0		
β	(D < 20) 0.5			(D ≥ 20) 1.0		

RIPPLE CURRENT MULTIPLIER

Frequency Coefficient

Coefficient	Freq. (Hz)			
Cap (µF)	120	1k	10k	100k
1~5.6	0.20	0.40	0.80	1.00
6.8~180	0.40	0.75	0.90	1.00
≥ 220	0.50	0.85	0.94	1.00

PART NUMBER SYSTEM (EXAMPLE : 250V 22µF)

1	23	456	7	89	10	11 12	13 14
E	RT	226	M	2E	G	20	RR



STANDARD RATINGS

Voltage (Code)		160V (2C)		200V (2D)		250V (2E)		350V (2V)	
Cap. (µF)	Code	Case Size	Ripple Current	Case Size	Ripple Current	Case Size	Ripple Current	Case Size	Ripple Current
4.7	475					8 x 12	160	10 x 12.5	150
5.6	565							10 x 12.5	180
6.8	685			8 x 12	204	8 x 12 10 x 12.5	215 250	10 x 16	280
10	106	10 x 16	320	10 x 16	320	10 x 16	320	10 x 20	350
22	226	10 x 20	500	10 x 16 10 x 20	453 500	10 x 16 10 x 20	453 500	12.5 x 20	650
33	336	10 x 20	650	10 x 16 10 x 20	589 650	10 x 16 12.5 x 20	640 800	16 x 20	900
47	476	10 x 20	750	12.5 x 20	980	12.5 x 20	980 1200*	16 x 20	1080
68	686	12.5 x 20	1180	12.5 x 25 16 x 20	1300 1300	16 x 20	1300	18 x 25	1470
82	826			16 x 20	1380	16 x 20	1380	18 x 25	1530
100	107	12.5 x 25 16 x 20	1420 1420	16 x 20	1420	16 x 25	1530		
150	157	16 x 25	1890	16 x 25	1890	18 x 25	1940		
220	227	18 x 25	2370	18 x 30	2648				

Maximum Allowable Ripple Current (mArms) at 105°C 100kHz

Case Size Φ D x L (mm)

Voltage (Code)		400V (2G)		450V (2W)	
Cap. (µF)	Code	Case Size	Ripple Current	Case Size	Ripple Current
1	105	8 x 12	60		
1.5	155	8 x 12 10 x 12.5	90 100		
1.8	185	8 x 12 10 x 12.5	95 120		
2.2	225	8 x 12 10 x 12.5	95 140	8 x 12	105
3.3	335	8 x 12 10 x 12.5	130 150		
4.7	475	8 x 12 10 x 16	171 220	8 x 16 10 x 20	176 220
5.6	565	10 x 16	250	10 x 20	250
6.8	685	10 x 16	280	10 x 12.5 10 x 20	228 280
10	106	10 x 16 10 x 20	317 350	10 x 20 12.5 x 20	397 450
15	156	12.5 x 25 12.5 x 20	487 550	12.5 x 25	600
22	226	12.5 x 20	760	12.5 x 25 16 x 20	698 730
33	336	12.5 x 25 16 x 20	861 900	16 x 20 16 x 25	891 980
47	476	12.5 x 25 16 x 20 16 x 25 18 x 20	1027 1073 1180 1180	16 x 25 18 x 20 18 x 25	1121 1093 1200
68	686	16 x 25 16 x 30 18 x 25	1374 1488 1470		
100	107			18 x 35	2088
120	127			18 x 40	2325

Maximum Allowable Ripple Current (mArms) at 105°C 100kHz

Case Size Φ D x L (mm)

* Special item with higher ripple current.

Specifications are subject to change without notice. Should a safety or technical concern arise regarding the product, please be sure to contact our sales offices or agents immediately.

TEMPERATURE CHARACTERISTICS



ENDURANCE



FEATURES

- Load life of 8,000~10,000 hours at 105°C.
- For electronic ballast.

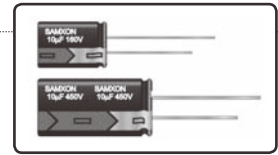

SPECIFICATIONS

Item	Performance Characteristics						
Operating Temperature Range	-25 to +105°C						
Rated Working Voltage Range	160 to 450V						
Nominal Capacitance Range	1 to 220µF						
Capacitance Tolerance	±20% at 120Hz, +20°C						
Leakage Current	I ≤ 0.02CV + 25 (µA) after 2 minutes application of rated working voltage at +20°C						
tan δ (120Hz, +20°C)	Working Voltage (V)	160	200	250	350	400	450
	tan δ (max.)	0.15	0.15	0.15	0.20	0.20	0.20
Low Temperature Characteristics	Impedance ratio max. at 120Hz						
	Rated Voltage (V)	160	200	250	350	400	450
	Z-25°C / Z+20°C	3	3	3	6	6	6
High Temperature Loading	Test time	ΦD	8~10	12.5~18	Post test requirements at +20°C		
	Load life		8,000h	10,000h	Leakage current : ≤ Initial specified value		
	Test temperature	+105°C			Cap. change : within ±20% of the initial measured value		
Shelf Life	Test conditions	Rated DC working voltage with rated ripple current			tan δ : ≤ 200% of the initial specified value		
	At +105°C no voltage applied after 1,000 hours and then being stabilized at +20°C the capacitors shall meet the following limits						
	Leakage current	: ≤ Initial specified value					
Industrial Standard	Cap. change	: within ±20% of the initial measured value					
	tan δ	: ≤ 200% of the initial specified value					

CASE SIZE TABLE

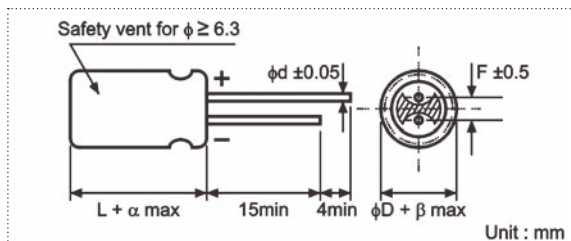

	ΦD	8 (L < 20)	8 (L ≥ 20)	10	12.5	16	18
F		3.5	3.5	5.0	5.0	7.5	7.5
Φd		0.5	0.6	0.6	0.6	0.8	0.8
α		(L < 20) 1.5		(L ≥ 20) 2.0			
β		(D < 20) 0.5		(D ≥ 20) 1.0			

RIPPLE CURRENT MULTIPLIER

Frequency Coefficient

Coefficient	Freq. (Hz)	120	1k	10k	100k
Cap (µF)	1~5.6	0.20	0.40	0.80	1.00
	6.8~180	0.40	0.75	0.90	1.00
	≥ 220	0.50	0.85	0.94	1.00

PART NUMBER SYSTEM (EXAMPLE : 200V 220µF)

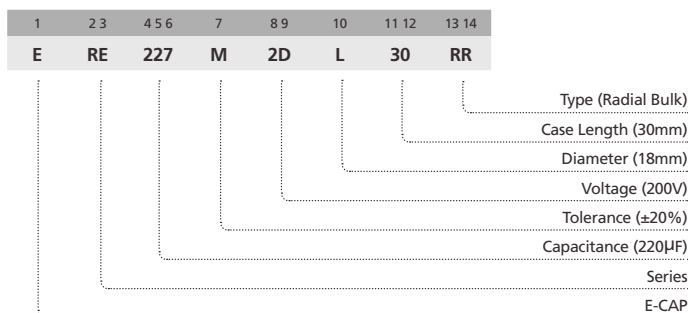

STANDARD RATINGS

Voltage (Code)		160V (2C)		200V (2D)		250V (2E)		350V (2V)	
Cap. (µF)	Code	Case Size	Ripple Current	Case Size	Ripple Current	Case Size	Ripple Current	Case Size	Ripple Current
6.8	685	8 x 12	160	8 x 12	160	8 x 12	150	10 x 16	220
10	106	10 x 16	250	10 x 16	250	10 x 12.5	228	10 x 16	254
						10 x 20	280	10 x 20	280
22	226	10 x 20	500	10 x 20	500	12.5 x 20	600	12.5 x 20	350
33	336	10 x 20	500	12.5 x 20	600	12.5 x 20	600	16 x 20	500
47	476	12.5 x 20	660	12.5 x 20	660	12.5 x 25	720	16 x 25	660
						16 x 20		18 x 20	
68	686	12.5 x 25	760	12.5 x 25	760	16 x 25	920	16 x 30	850
		16 x 20		16 x 20		18 x 20		18 x 25	
100	107	16 x 25	1120	16 x 25	1120	16 x 30	1200		
		18 x 20		18 x 20		18 x 25			
150	157	16 x 30	1360	16 x 30	1360	18 x 30	1500		
		18 x 25		18 x 25					
220	227	16 x 30	1400	18 x 30	1700				
		18 x 25							

Maximum Allowable Ripple Current (mArms) at 105°C 100kHz

Case Size ΦD x L (mm)

Voltage (Code)		400V (2G)		450V (2W)	
Cap. (µF)	Code	Case Size	Ripple Current	Case Size	Ripple Current
1	105	8 x 12	38		
1.5	155	8 x 12	72		
		10 x 12.5	80		
1.8	185	8 x 12	76		
		10 x 12.5	96		
2.2	225	8 x 12	76		
		10 x 12.5	112		
3.3	335	10 x 12.5	120		
4.7	475	10 x 16	176	10 x 20	120
5.6	565	10 x 16	200	10 x 20	135
6.8	685	10 x 16	220	10 x 20	150
10	106	10 x 20	280	12.5 x 20	320
22	226	12.5 x 25	430	16 x 25	560
		16 x 20		18 x 20	
33	336	16 x 25	640	16 x 30	700
		18 x 20		18 x 25	
47	476	16 x 30	840	18 x 30	880
		18 x 25			
68	686	18 x 30	1000		

Maximum Allowable Ripple Current (mArms) at 105°C 100kHz

Case Size ΦD x L (mm)

Specifications are subject to change without notice. Should a safety or technical concern arise regarding the product, please be sure to contact our sales offices or agents immediately.

FEATURES

- High ripple current at high frequency, load life of 8,000~10,000 hours at 105°C.
- For electronic ballast, power supply input circuit.



SPECIFICATIONS

Item	Performance Characteristics							
Operating Temperature Range	-40 to +105°C				-25 to +105°C			
Rated Working Voltage Range	160 to 400V				450 to 500V			
Nominal Capacitance Range	1 to 330µF							
Capacitance Tolerance	±20% at 120Hz, +20°C							
Leakage Current	I ≤ 0.02CV + 25 (µA) after 2 minutes application of rated working voltage at +20°C							
tan δ (120Hz, +20°C)	Working Voltage (V)	160	200	250	350	400	450	500
	tan δ (max.)	0.15	0.15	0.15	0.20	0.20	0.20	0.20
Low Temperature Characteristics	Impedance ratio max. at 120Hz							
	Rated Voltage (V)	160	200	250	350	400	450	500
	Z-25°C / Z+20°C	3	3	3	5	5	6	12
High Temperature Loading	Test time	ΦD	8-10	12.5-18	Post test requirements at +20°C			
	Load life		8,000h	10,000h	Leakage current : ≤ Initial specified value			
	Test temperature		+105°C		Cap. change : within ±20% of the initial measured value			
Shelf Life	Test conditions	Rated DC working voltage with rated ripple current		tan δ		: ≤ 200% of the initial specified value		
	At +105°C no voltage applied after 1,000 hours and then being stabilized at +20°C the capacitors shall meet the following limits							
	Leakage current	: ≤ Initial specified value						
Industrial Standard	Cap. change	: within ±20% of the initial measured value						
	tan δ	: ≤ 200% of the initial specified value						
Industrial Standard	JIS C - 5101-4 (IEC 60384-4)							

CASE SIZE TABLE



	ΦD	8 (L < 20)	8 (L ≥ 20)	10	12.5	16	18
F		3.5	3.5	5.0	5.0	7.5	7.5
Φd		0.5	0.6	0.6	0.6	0.8	0.8
α		(L < 20) 1.5		(L ≥ 20) 2.0			
β		(D < 20) 0.5		(D ≥ 20) 1.0			

RIPPLE CURRENT MULTIPLIER

Frequency Coefficient

Coefficient	Freq. (Hz)	120	1k	10k	100k
Cap (µF)	1~5.6	0.20	0.40	0.80	1.00
	6.8~180	0.40	0.75	0.90	1.00
	≥220	0.50	0.85	0.94	1.00

PART NUMBER SYSTEM (EXAMPLE : 350V 33µF)

1	23	456	7	89	10	11 12	13 14
E	RD	336	M	2V	K	20	RR



STANDARD RATINGS

Voltage (Code)		160V (2C)		200V (2D)		250V (2E)		350V (2V)	
Cap. (μF)	Code	Case Size	Ripple Current	Case Size	Ripple Current	Case Size	Ripple Current	Case Size	Ripple Current
10	106					10 x 16	342	10 x 20	350
22	226	10 x 20	500	10 x 16	544	10 x 16	508	12.5 x 20	480
				10 x 20	600	10 x 20	560		
33	336	10 x 20	580	10 x 20	650	12.5 x 20	710	16 x 20	640
						16 x 15	728		
47	476	10 x 20	750	10 x 20	697	12.5 x 20	834	16 x 25	800
				12.5 x 20	790	12.5 x 25	920	18 x 20	800
						16 x 20	990	16 x 30	1100
68	686	12.5 x 20	950	12.5 x 25	950	16 x 20	1000	18 x 20	910
				16 x 20	1000			18 x 25	1000
82	826	12.5 x 25	1060	16 x 20	1100	16 x 25	1200	18 x 25	1100
						18 x 20	1200		
100	107	12.5 x 25	1170	16 x 25	1300	16 x 25	1385	18 x 25	1110
		16 x 20	1280	18 x 20	1280	16 x 30	1500	18 x 30	1200
						18 x 25	1500		
150	157	16 x 25	1400	16 x 25	1400	18 x 25	1665		
		18 x 20	1400			18 x 30	1800		
220	227	16 x 30	1700	18 x 30	2000	18 x 40	2100		
		18 x 25	1500						
330	337	18 x 30	2000	18 x 40	2400				

Maximum Allowable Ripple Current (mArms) at 105°C 100kHz

Case Size ΦD x L (mm)

Voltage (Code)		400V (2G)		450V (2W)		500V (2H)	
Cap. (μF)	Code	Case Size	Ripple Current	Case Size	Ripple Current	Case Size	Ripple Current
1	105	6.3 x 11	34				
		8 x 12	41				
1.5	155	8 x 12	77				
		10 x 12.5	86				
1.8	185	8 x 12	81				
		10 x 12.5	103				
2.2	225	8 x 12	81				
		10 x 12.5	120				
3.3	335	8 x 12	110				
		10 x 12.5	128				
4.7	475	8 x 12	146	10 x 20	128		
		10 x 16	188				
5.6	565	10 x 16	214	10 x 20	144		
		10 x 12.5	207				
6.8	685	10 x 16	230				
		10 x 16	276	10 x 20	309		
10	106	10 x 20	300	12.5 x 20	350	12.5 x 20	280
				12.5 x 20	508	12.5 x 25	390
15	156	12.5 x 20	410	12.5 x 25	560	16 x 20	390
				12.5 x 20	590	16 x 25	500
22	226	12.5 x 25	500	12.5 x 25	651	18 x 20	500
		16 x 20	600	16 x 20	680		
				12.5 x 25	683		
33	336	12.5 x 25	698	16 x 25	785	16 x 30	630
					975*		
		16 x 20	730	16 x 30	850	18 x 25	630
				18 x 25	850		
47	476	16 x 20	764	16 x 25	1250*		
		16 x 25	840	16 x 30	936	18 x 30	750
		18 x 20	840	18 x 30	1000		
				18 x 24	1450*		
68	686	18 x 25	1110	18 x 25	1054	18 x 35	890
		18 x 30	1200		1550*		
				18 x 30	1140		
82	826	18 x 25	1550			18 x 45	980
		18 x 40	1500				
120	127	18 x 35	2250*				

Maximum Allowable Ripple Current (mArms) at 105°C 100kHz

Case Size ΦD x L (mm)

* Special item with higher ripple current.

Specifications are subject to change without notice. Should a safety or technical concern arise regarding the product, please be sure to contact our sales offices or agents immediately.

FEATURES

- High ripple current at high frequency, load life of 10,000~12,000 hours at 105°C.
- For electronic ballast.



SPECIFICATIONS

Item	Performance Characteristics							
Operating Temperature Range	-40 to +105°C				-25 to +105°C			
Rated Working Voltage Range	160 to 400V				450 to 500V			
Nominal Capacitance Range	1 to 220µF							
Capacitance Tolerance	±20% at 120Hz, +20°C							
Leakage Current	I ≤ 0.02CV + 25 (µA) after 2 minutes application of rated working voltage at +20°C							
tan δ (120Hz, +20°C)	Working Voltage (V)	160	200	250	350	400	450	500
	tan δ (max.)	0.15	0.15	0.15	0.20	0.20	0.20	0.20
Low Temperature Characteristics	Impedance ratio max. at 120Hz							
	Rated Voltage (V)	160	200	250	350	400	450	500
	Z-25°C / Z+20°C	3	3	3	5	5	6	12
High Temperature Loading	Test time	ΦD	8-10	12.5-18	500V	Post test requirements at +20°C		
		Load life	10,000h	12,000h	10,000h	Leakage current : ≤ Initial specified value		
	Test temperature : +105°C Test conditions : Rated DC working voltage with rated ripple current					Cap. change : within ±20% of the initial measured value tan δ : ≤ 200% of the initial specified value		
Shelf Life	At +105°C no voltage applied after 1,000 hours and then being stabilized at +20°C the capacitors shall meet the following limits Leakage current : ≤ Initial specified value Cap. change : within ±20% of the initial measured value tan δ : ≤ 200% of the initial specified value							
Industrial Standard	JIS C - 5101-4 (IEC 60384-4)							

CASE SIZE TABLE



ΦD	8 (L < 20)	8 (L ≥ 20)	10	12.5	16	18
F	3.5	3.5	5.0	5.0	7.5	7.5
Φd	0.5	0.6	0.6	0.6	0.8	0.8
α	(L < 20) 1.5			(L ≥ 20) 2.0		
β	(D < 20) 0.5			(D ≥ 20) 1.0		

RIPPLE CURRENT MULTIPLIER

Frequency Coefficient

Coefficient	120	1k	10k	100k
1-5.6	0.20	0.40	0.80	1.00
6.8-180	0.40	0.75	0.90	1.00
≥ 220	0.50	0.85	0.94	1.00

PART NUMBER SYSTEM (EXAMPLE : 160V 22µF)



STANDARD RATINGS

Voltage (Code)		160V (2C)		200V (2D)		250V (2E)		350V (2V)	
Cap. (µF)	Code	Case Size	Ripple Current	Case Size	Ripple Current	Case Size	Ripple Current	Case Size	Ripple Current
6.8	685							10 x 16	220
10	106	10 x 16	250	10 x 16	250	10 x 20	300	10 x 20	280
22	226	10 x 20	500	10 x 20	500	12.5 x 20	600	12.5 x 25	350
33	336	10 x 20	565	12.5 x 20	600	12.5 x 20	630	16 x 20	600
47	476	12.5 x 20	725	12.5 x 20	780	12.5 x 25	720	16 x 25	700
						16 x 20	750	18 x 20	750
68	686	12.5 x 25	950	12.5 x 25	950	16 x 25	1000	16 x 30	1100
		16 x 20	970	16 x 20	970	18 x 20	920	18 x 25	875
100	107	16 x 25	1280	16 x 25	1280	16 x 30	1400		
		18 x 20	1180	18 x 20	1180	18 x 25	1345		
150	157	16 x 30	1360	16 x 30	1360	18 x 30	1500		
		18 x 25	1360	18 x 25	1360				
220	227	16 x 30	1400	18 x 30	1700				
		18 x 25	1400						

Maximum Allowable Ripple Current (mArms) at 105°C 100kHz

Case Size Φ D x L (mm)

Voltage (Code)		400V (2G)		450V (2W)		500V (2H)	
Cap. (µF)	Code	Case Size	Ripple Current	Case Size	Ripple Current	Case Size	Ripple Current
1	105	8 x 12	38				
1.5	155	8 x 12	72				
		10 x 12.5	80				
1.8	185	8 x 12	76				
		10 x 12.5	96				
2.2	225	8 x 12	76				
		10 x 12.5	112				
3.3	335	10 x 12.5	120				
4.7	475	10 x 16	176	10 x 20	120		
5.6	565	10 x 16	200	10 x 20	135		
6.8	685	10 x 16	220	10 x 20	150		
10	106	10 x 20	280	12.5 x 20	320	12.5 x 20	240
				16 x 25	560	12.5 x 25	300
15	156			18 x 20	560	16 x 20	300
22	226	12.5 x 25	430	16 x 25	560	16 x 25	430
		16 x 20	600	18 x 20	560	18 x 20	430
33	336	16 x 25	640	16 x 30	700	16 x 30	540
		18 x 20	640	18 x 25	700	18 x 25	540
47	476	16 x 30	840	18 x 30	900	18 x 30	640
		18 x 25	840				
68	686	18 x 30	1000			18 x 35	750
82	826					18 x 45	800

Maximum Allowable Ripple Current (mArms) at 105°C 100kHz

Case Size Φ D x L (mm)

Specifications are subject to change without notice. Should a safety or technical concern arise regarding the product, please be sure to contact our sales offices or agents immediately.

FEATURES

- Wide operating temperature range, it as long load life product at 125°C.
- Suitable for use in DC or pulse circuits in various electronic and industrial.



SPECIFICATIONS

Item	Performance Characteristics					
Operating Temperature Range	-40 to +125°C					
Rated Working Voltage Range	10 to 50V					
Nominal Capacitance Range	3.3 to 3900µF					
Capacitance Tolerance	±20% at 120Hz, +20°C					
Leakage Current	I ≤ 0.03CV or 4 (µA) whichever is greater measured after 1 minute application of rated working voltage at +20°C					
tan δ (120Hz, +20°C)	Working Voltage (V)	10	16	25	35	50
	tan δ (max.)	0.22	0.18	0.16	0.14	0.12
For capacitance value >1000µF, add 0.02 per another 1000µF						
Low Temperature Characteristics	Impedance ratio max. at 120Hz					
	Working Voltage (V)	10	16	25	35	50
	Z-25°C / Z+20°C	3	2	2	2	2
Z-40°C / Z+20°C		6	4	4	4	4
High Temperature Loading	Test time	ΦD	<8	≥8	Post test requirements at +20	
	Load life		1,000h	2,000h	Leakage current : ≤Initial specified value	
	Test temperature	+125°C			Cap. change : within ±20% of the initial measured value	
Test conditions		Rated DC working voltage with rated ripple current			tan δ : ≤200% of the initial specified value	
Shelf Life	At +125°C no voltage applied after 1,000 hours and then being stabilized at +20°C the capacitors shall meet the following limits					
	Leakage current : ≤Initial specified value					
	Cap. change : within ±20% of the initial measured value					
	tan δ : ≤200% of the initial specified value					
Industrial Standard	JIS C - 5101-4 (IEC 60384-4)					

CASE SIZE TABLE



ΦD	5	6.3	8 (L < 20)	8 (L ≥ 20)	10	12.5	16	18
F	2.0	2.5	3.5	3.5	5.0	5.0	7.5	7.5
φd	0.5	0.5	0.5	0.6	0.6	0.6	0.8	0.8
α	(L < 20) 1.5			(L ≥ 20) 2.0				
β	(D < 20) 0.5			(D ≥ 20) 1.0				

RIPPLE CURRENT MULTIPLIER

Frequency Coefficient

Rated Voltage	Coefficient Cap (µF)	Freq. (Hz)				
		50	120	300	1k	10k~100k
10~50V	≤47	0.75	1.00	1.35	1.57	2.00
	100~470	0.80	1.00	1.23	1.34	1.50
	≥560	0.85	1.00	1.10	1.13	1.15

PART NUMBER SYSTEM (EXAMPLE : 16V 330µF)



STANDARD RATINGS

Voltage (Code)		10V (1A)		16V (1C)		25V (1E)		35V (1E)		50V (1H)	
Cap. (µF)	Code	Case Size	Ripple Current	Case Size	Ripple Current	Case Size	Ripple Current	Case Size	Ripple Current	Case Size	Ripple Current
3.3	335									5 x 11	21
4.7	475									5 x 11	26
10	106									5 x 11	38
22	226							5 x 11	47	5 x 11	55
33	336					5 x 11	53	5 x 11	56	6.3 x 11	81
47	476			5 x 11	56	5 x 11	59	6.3 x 11	84	6.3 x 11	93
100	107	5 x 11	74	5 x 11	88	6.3 x 11	111	6.3 x 11	118	8 x 12	160
220	227	6.3 x 11	135	6.3 x 11	149	8 x 12	200	10 x 12.5	240		
330	337	6.3 x 11	167	8 x 12	221	8 x 12	238				
470	477	8 x 12	237	8 x 12	256	10 x 16	366				
1000	108					10 x 20	575				
2200	228					12.5 x 25	908				
3900	398					16 x 30	1356				

Maximum Allowable Ripple Current (mArms) at 125°C 120Hz

Case Size Φ D x L (mm)

Specifications are subject to change without notice. Should a safety or technical concern arise regarding the product, please be sure to contact our sales offices or agents immediately.

FEATURES

- High temperature, high ripple current at high frequency, load life of 1,000~4,000 hours at 130°C.
- Specially designed for electronic ballast and energy saving lamp.

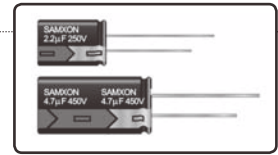

SPECIFICATIONS

Item	Performance Characteristics											
Operating Temperature Range	-40 to +130°C	-25 to +130°C										
Rated Working Voltage Range	10 to 100V	200 to 450V										
Nominal Capacitance Range	1 to 4700µF											
Capacitance Tolerance	±20% at 120Hz, +20°C											
Leakage Current	I ≤ 0.01CV or 3 (µA) whichever is greater measured after 2 minutes application of rated working voltage at +20°C	I ≤ 0.02CV + 25 (µA) after 2 minutes application of rated working voltage at +20°C										
tan δ (120Hz, +20°C)	Working Voltage (V)	10 16 25 35 50 63 100 200 250 350 400 450										
	tan δ (max.)	0.20 0.16 0.14 0.12 0.10 0.09 0.15 0.15 0.15 0.20 0.20 0.20										
For capacitance > 1000µF, add 0.02 per another 1000µF												
Low Temperature Characteristics	Impedance ratio max. at 120Hz											
	Working Voltage (V)	10 16 25 35 50 63 100 200 250 350 400 450										
	Z-25°C / Z+20°C	3 2 2 2 2 2 2 3 3 5 6 6										
	Z-40°C / Z+20°C	6 4 3 3 3 3 3 - - - - -										
High Temperature Loading	Test time	ΦD 6.3 8-10 ≥12.5	Post test requirements at +20°C									
	Load life	1,000h 2,000h 4,000h	Leakage current : ≤ Initial specified value									
	Test temperature	+130°C	Cap. change : within ±30% of the initial measured value									
	Test conditions	Rated DC working voltage with rated ripple current	tan δ : ≤ 300% of the initial specified value (200~450V within 200%)									
Shelf Life	At +105°C no voltage applied after 1,000 hours and then being stabilized at +20°C the capacitors shall meet the following limits											
	Leakage current	≤ Initial specified value										
	Cap. change	within ±30% of the initial measured value										
	tan δ	≤ 300% of the initial specified value (200~450V within 200%)										
Industrial Standard	JIS C - 5101-4 (IEC 60384-4)											

CASE SIZE TABLE

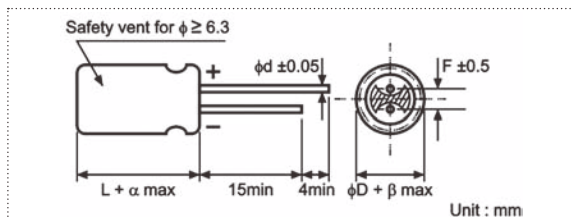

ΦD	6.3	8(L<20)	8(L≥20)	10	12.5	16	18
F	2.5	3.5	3.5	5.0	5.0	7.5	7.5
Φd	0.5	0.5	0.6	0.6	0.6	0.8	0.8
α	(L < 20) 1.5			(L ≥ 20) 2.0			
β	(D < 20) 0.5			(D ≥ 20) 1.0			

RIPPLE CURRENT MULTIPLIER

Frequency Coefficient

Rated Voltage	Coefficient	Freq. (Hz)	120	1k	10k	100k
	Cap (µF)					
10~100V	4.7		0.42	0.60	0.80	1.00
	10~33		0.55	0.75	0.90	1.00
	47~330		0.70	0.85	0.95	1.00
	470~1500		0.75	0.90	0.98	1.00
	2200~4700		0.80	0.95	1.00	1.00
200~450V	1~5.6		0.20	0.40	0.80	1.00
	6.8~15		0.30	0.60	0.90	1.00
	22~33		0.50	0.80	0.90	1.00

PART NUMBER SYSTEM (EXAMPLE : 16V 1000µF)

1	23	456	7	89	10	11 12	13 14
E	RA	108	M	1C	G	20	RR



STANDARD RATINGS

Voltage (Code)		10V (1A)			16V (1C)		
Cap. (μF)	Code	Case Size	Impedance	Ripple Current	Case Size	Impedance	Ripple Current
330	337	8 x 12	0.220	360	8 x 12	0.220	360
470	477	10 x 12.5	0.150	620	10 x 12.5	0.150	620
1000	108	10 x 20	0.073	960	10 x 20	0.073	960
2200	228	12.5 x 25	0.040	1430	12.5 x 25	0.040	1430
3300	338	16 x 25	0.038	1900	16 x 30	0.034	2300
4700	478	16 x 30	0.034	2300	16 x 35	0.031	2550

Maximum Allowable Ripple Current (mArms) at 130°C 100kHz

Case Size ΦD x L (mm)

Maximum Impedance (Ω) at 20°C 100kHz

Voltage (Code)		25V (1E)			35V (1V)		
Cap. (μF)	Code	Case Size	Impedance	Ripple Current	Case Size	Impedance	Ripple Current
100	107				8 x 12	0.220	360
220	227	8 x 12	0.220	360	10 x 12.5	0.150	620
330	337	10 x 12.5	0.150	620	10 x 16	0.100	800
470	477	10 x 16	0.100	800	10 x 20	0.073	960
1000	108	12.5 x 20	0.055	1100	12.5 x 25	0.040	1430
2200	228	16 x 30	0.034	2300	16 x 35	0.031	2550
3300	338	16 x 35	0.031	2550	18 x 35	0.028	2800

Maximum Allowable Ripple Current (mArms) at 130°C 100kHz

Case Size ΦD x L (mm)

Maximum Impedance (Ω) at 20°C 100kHz

Voltage (Code)		50V (1H)			63V (1J)			100V (2A)		
Cap. (μF)	Code	Case Size	Impedance	Ripple Current	Case Size	Impedance	Ripple Current	Case Size	Impedance	Ripple Current
4.7	475	8 x 12	0.850	100				8 x 12	1.300	100
10	106	8 x 12	0.600	200				8 x 12	1.000	200
22	226	8 x 12	0.350	260				8 x 12	0.670	220
33	336	8 x 12	0.280	300	8 x 12	0.400	250	10 x 12.5	0.450	260
47	476	8 x 12	0.280	300	10 x 12.5	0.270	400	10 x 16	0.330	330
100	107	10 x 12.5	0.180	520	10 x 16	0.200	450	12.5 x 20	0.170	670
220	227	10 x 20	0.082	890	12.5 x 20	0.100	820	16 x 25	0.130	1100
330	337	12.5 x 20	0.065	1000	12.5 x 25	0.072	1000	16 x 30	0.100	1300
470	477	12.5 x 25	0.051	1200	16 x 25	0.069	1500	18 x 30	0.092	1600
1000	108	16 x 30	0.037	2180	16 x 30	0.056	1850			
1500	158				18 x 40	0.043	2350			
2200	228	18 x 40	0.029	2800						

Maximum Allowable Ripple Current (mArms) at 130°C 100kHz

Case Size ΦD x L (mm)

Maximum Impedance (Ω) at 20°C 100kHz

Specifications are subject to change without notice. Should a safety or technical concern arise regarding the product, please be sure to contact our sales offices or agents immediately.

STANDARD RATINGS

Voltage (Code)		200V (2D)		250V (2E)	
Cap. (μF)	Code	Case Size	Ripple Current	Case Size	Ripple Current
4.7	475	6.3 x 11	100	8 x 12	120
		8 x 12	120		
5.6	565	8 x 12	130	8 x 16	180
		8 x 16	180		
6.8	685	8 x 12	130	8 x 16	180
		8 x 16	180		
8.2	825	10 x 16	200	10 x 16	200
10	106	8 x 16	200	8 x 20	240
		8 x 20	240		
15	156	8 x 16	200	10 x 16	240
		8 x 20	240		
22	226	8 x 20	300	10 x 20	260
		10 x 16	240		
33	336	10 x 20	320	12.5 x 20	350

Maximum Allowable Ripple Current (mArms) at 130°C 100kHz

Case Size ΦD x L (mm)

Voltage (Code)		350V (2V)		400V (2G)		450V (2W)	
Cap. (μF)	Code	Case Size	Ripple Current	Case Size	Ripple Current	Case Size	Ripple Current
1	105	6.3 x 11	60	6.3 x 11	60	8 x 12	59
		8 x 12	65	8 x 12	65		
1.5	155	8 x 12	75	8 x 12	75	8 x 12	68
		8 x 16	80	8 x 16	80		
1.8	185	8 x 12	75	8 x 12	75	8 x 12	68
		8 x 16	85	8 x 16	85		
2.2	225	8 x 12	75	8 x 12	75	8 x 12	68
		8 x 16	90	8 x 16	90		
2.7	275	8 x 20	110	8 x 20	110	8 x 16	88
		8 x 16	95	8 x 16	95		
3.3	335	8 x 16	100	8 x 16	100	8 x 16	90
		8 x 20	120	8 x 20	120		
4.7	475	8 x 20	120	8 x 20	120	10 x 16	112
		10 x 16	125	10 x 16	125		
5.6	565	10 x 16	130	10 x 16	130	10 x 16	115
		10 x 20	145	10 x 20	145		
6.8	685	10 x 20	150	10 x 20	150	10 x 20	135
8.2	825	10 x 20	168	10 x 20	168	10 x 20	150
10	106	12.5 x 20	186	12.5 x 20	186	12.5 x 20	170
15	156	12.5 x 25	226	12.5 x 25	226	12.5 x 25	200
22	226	16 x 25	283	16 x 25	283		
33	336	16 x 30	375	16 x 30	375		

Maximum Allowable Ripple Current (mArms) at 130°C 100kHz

Case Size ΦD x L (mm)

Specifications are subject to change without notice. Should a safety or technical concern arise regarding the product, please be sure to contact our sales offices or agents immediately.



FEATURES

- High temperature, high ripple current at high frequency, load life of 3,000~4,000 hours at 130°C.
- Specially designed for electronic ballast and energy saving lamp.



SPECIFICATIONS

Item	Performance Characteristics						
Operating Temperature Range	-40 to +130°C					-25 to +130°C	
Rated Working Voltage Range	160 to 400V					450V	
Nominal Capacitance Range	1.5 to 100μF						
Capacitance Tolerance	±20% at 120Hz, +20°C						
Leakage Current	I ≤ 0.02CV + 25 (μA) after 2 minutes application of rated working voltage at +20°C						
tan δ (120Hz, +20°C)	Working Voltage (V)	160	200	250	350	400	450
	tan δ (max.)	0.15	0.15	0.15	0.20	0.20	0.20
Low Temperature Characteristics	Impedance ratio max. at 120Hz						
	Rated Voltage (V)	160	200	250	350	400	450
	Z-25°C / Z+20°C	3	3	3	5	5	6
High Temperature Loading	Test time	ΦD ≤ 12.5	> 12.5	Post test requirements at +20°C			
	Load life	3,000h	4,000h	Leakage current : ≤ Initial specified value Cap. change : within ±30% of the initial measured value tan δ : ≤ 300% of the initial specified value			
	Test temperature	+130°C					
	Test conditions	Rated DC working voltage with rated ripple current					
Shelf Life	At +105°C no voltage applied after 1,000 hours and then being stabilized at +20°C the capacitors shall meet the following limits Leakage current : ≤ Initial specified value Cap. change : within ±30% of the initial measured value tan δ : ≤ 300% of the initial specified value						
Industrial Standard	JIS C - 5101-4 (IEC 60384-4)						

CASE SIZE TABLE

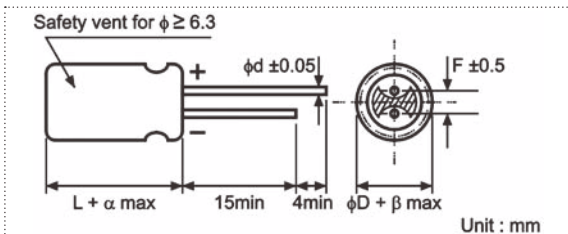

ΦD	8 (L < 20)	8 (L ≥ 20)	10	12.5	16	18
F	3.5	3.5	5.0	5.0	7.5	7.5
Φd	0.5	0.6	0.6	0.6	0.8	0.8
α	(L < 20) 1.5		(L ≥ 20) 2.0			
β	(D < 20) 0.5		(D ≥ 20) 1.0			

RIPPLE CURRENT MULTIPLIER

Frequency Coefficient

Coefficient	120	1k	10k	100k
Cap (μF)				
1.5~5.6	0.20	0.40	0.80	1.00
6.8~100	0.40	0.75	0.90	1.00

PART NUMBER SYSTEM (EXAMPLE : 200V 100μF)

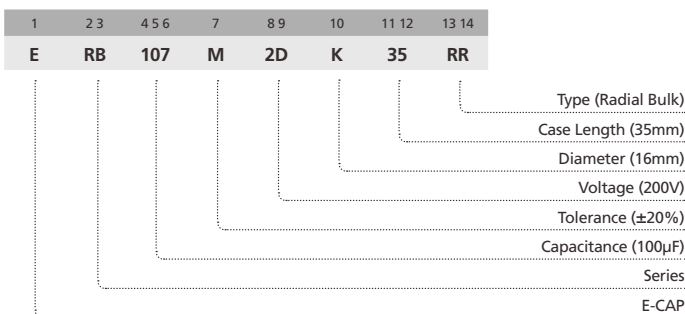

RB

Miniature Aluminum Electrolytic Capacitors

STANDARD RATINGS

Voltage (Code)		160V (2C)		200V (2D)		250V (2E)		350V (2V)	
Cap. (µF)	Code	Case Size	Ripple Current	Case Size	Ripple Current	Case Size	Ripple Current	Case Size	Ripple Current
1.8	185							10 x 16	62
2.2	225							10 x 16	70
2.8	285							10 x 16	76
3.3	335							10 x 16	84
4.7	475					10 x 16	88	10 x 20	105
5.6	565					10 x 16	88	12.5 x 20	121
6.8	685					10 x 16	96	12.5 x 20	176
8.2	825	10 x 16	96	10 x 16	100	10 x 16	104	12.5 x 20	192
10	106	10 x 16	200	10 x 16	200	10 x 16	224	12.5 x 20	224
15	156	10 x 16	336	10 x 20	336	12.5 x 20	360	12.5 x 25	240
22	226	10 x 20	400	12.5 x 20	400	12.5 x 20	480	16 x 25	252
33	336	12.5 x 20	400	12.5 x 20	480	12.5 x 25	480		
47	476	12.5 x 25	528	12.5 x 25	528	16 x 25	518		
68	686	16 x 25	547	16 x 25	547				
100	107	16 x 25	806						

Maximum Allowable Ripple Current (mArms) at 130°C 100kHz

Case Size Φ D x L (mm)

Voltage (Code)		400V (2G)		450V (2W)	
Cap. (µF)	Code	Case Size	Ripple Current	Case Size	Ripple Current
1.5	155			10 x 16	70
1.8	185	10 x 16	72	10 x 16	74
2.2	225	10 x 16	74	10 x 16	77
2.8	285	10 x 16	80	10 x 16	80
3.3	335	10 x 16	88	10 x 16	88
4.7	475	10 x 20	104	10 x 20	104
5.6	565	12.5 x 20	112	12.5 x 20	112
6.8	685	12.5 x 20	176	12.5 x 20	120
8.2	825	12.5 x 20	208	12.5 x 20	224
10	106	12.5 x 20	224	12.5 x 20	256
15	156	12.5 x 25	256	12.5 x 25	336

Maximum Allowable Ripple Current (mArms) at 130°C 100kHz

Case Size Φ D x L (mm)

Specifications are subject to change without notice. Should a safety or technical concern arise regarding the product, please be sure to contact our sales offices or agents immediately.

+130°C, High Temperature (高温度), High Ripple Current (高紋波), Longer Life Assurance (較長壽命)

FEATURES

- High temperature, high ripple current at high frequency, load life of 5,000–6,000 hours at 130°C.
- Specially designed for electronic ballast and energy saving lamp.



SPECIFICATIONS

Item	Performance Characteristics						
Operating Temperature Range	-25 to +130°C						
Rated Working Voltage Range	160 to 450V						
Nominal Capacitance Range	1.5 to 100µF						
Capacitance Tolerance	±20% at 120Hz, +20°C						
Leakage Current	I ≤ 0.02CV + 25 (µA) after 2 minutes application of rated working voltage at +20°C						
tan δ (120Hz, +20°C)	Working Voltage (V)	160	200	250	350	400	450
	tan δ (max.)	0.15	0.15	0.15	0.20	0.20	0.20
Low Temperature Characteristics	Impedance ratio max. at 120Hz						
	Rated Voltage (V) Z-25°C / Z+20°C	160	200	250	350	400	450
High Temperature Loading	Test time	ΦD ≤ 12.5	> 12.5	Post test requirements at +20°C			
	Load life	5,000h	6,000h	Leakage current : ≤ Initial specified value Cap. change : within ±30% of the initial measured value tan δ : ≤ 200% of the initial specified value			
Shelf Life	Test temperature	+130°C					Cap. change : within ±30% of the initial measured value
	Test conditions	Rated DC working voltage with rated ripple current					tan δ : ≤ 200% of the initial specified value
Industrial Standard	At +105°C no voltage applied after 1,000 hours and then being stabilized at +20°C the capacitors shall meet the following limits						
	Leakage current : ≤ Initial specified value Cap. change : within ±30% of the initial measured value tan δ : ≤ 200% of the initial specified value						

CASE SIZE TABLE



ΦD	10	12.5	16
F	5.0	5.0	7.5
Φd	0.6	0.6	0.8
α	(L < 20) 1.5		(L ≥ 20) 2.0
β	(D < 20) 0.5		(D ≥ 20) 1.0

RIPPLE CURRENT MULTIPLIER

Frequency Coefficient

Coefficient	120	1k	10k	100k
Cap (µF)				
1.5~5.6	0.20	0.40	0.80	1.00
6.8~100	0.40	0.75	0.90	1.00

PART NUMBER SYSTEM (EXAMPLE : 250V 10µF)



RC

Miniature Aluminum Electrolytic Capacitors

STANDARD RATINGS

Voltage (Code)		160V (2C)		200V (2D)		250V (2E)		350V (2V)	
Cap. (µF)	Code	Case Size	Ripple Current	Case Size	Ripple Current	Case Size	Ripple Current	Case Size	Ripple Current
2.2	225							10 x 16	50
3.3	335							10 x 16	58
4.7	475					10 x 16	56	10 x 20	70
5.6	565					10 x 16	60	12.5 x 20	85
6.8	685					10 x 16	65	12.5 x 20	120
8.2	825	10 x 16	65	10 x 16	70	10 x 16	70	12.5 x 20	135
10	106	10 x 16	140	10 x 16	140	10 x 16	155	12.5 x 20	155
15	156	10 x 16	235	10 x 20	235	12.5 x 20	250	12.5 x 25	168
22	226	10 x 20	280	12.5 x 20	280	12.5 x 20	335	16 x 25	175
33	336	12.5 x 20	290	12.5 x 20	335	12.5 x 25	335		
47	476	12.5 x 25	365	12.5 x 25	365	16 x 25	360		
68	686	16 x 25	380	16 x 25	380				
100	107	16 x 25	565						

Maximum Allowable Ripple Current (mArms) at 130°C 100kHz

Case Size Φ D x L (mm)

Voltage (Code)		400V (2G)		450V (2W)	
Cap. (µF)	Code	Case Size	Ripple Current	Case Size	Ripple Current
1.5	155			10 x 16	50
1.8	185	10 x 16	50	10 x 16	52
2.2	225	10 x 16	52	10 x 16	54
2.8	285	10 x 16	56	10 x 16	56
3.3	335	10 x 16	62	10 x 16	62
4.7	475	10 x 20	72	10 x 20	72
5.6	565	12.5 x 20	78	12.5 x 20	78
6.8	685	12.5 x 20	120	12.5 x 20	84
8.2	825	12.5 x 20	145	12.5 x 20	156
10	106	12.5 x 20	155	12.5 x 20	179
15	156	12.5 x 25	180	12.5 x 25	235

Maximum Allowable Ripple Current (mArms) at 130°C 100kHz

Case Size Φ D x L (mm)

Specifications are subject to change without notice. Should a safety or technical concern arise regarding the product, please be sure to contact our sales offices or agents immediately.

FEATURES

- Standard, for audio equipment.
- Low distortion ratio ensured with anti-vibration structures.

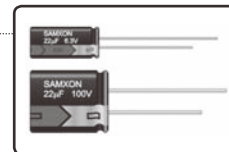

SPECIFICATIONS

Item	Performance Characteristics																											
Operating Temperature Range	-40 to +85°C																											
Rated Working Voltage Range	6.3 to 100V																											
Nominal Capacitance Range	2.2 to 10000µF																											
Capacitance Tolerance	±20% at 120Hz, +20°C																											
Leakage Current	I ≤ 0.01CV or 3 (µA) whichever is greater measured after 2 minutes application of rated working voltage at +20°C																											
tan δ (120Hz, +20°C)	<table border="1"> <tr> <th>Working Voltage (V)</th> <td>6.3</td> <td>10</td> <td>16</td> <td>25</td> <td>35</td> <td>50</td> <td>63</td> <td>100</td> </tr> <tr> <th>tan δ (max.)</th> <td>0.22</td> <td>0.19</td> <td>0.16</td> <td>0.14</td> <td>0.12</td> <td>0.10</td> <td>0.09</td> <td>0.08</td> </tr> </table>	Working Voltage (V)	6.3	10	16	25	35	50	63	100	tan δ (max.)	0.22	0.19	0.16	0.14	0.12	0.10	0.09	0.08									
	Working Voltage (V)	6.3	10	16	25	35	50	63	100																			
tan δ (max.)	0.22	0.19	0.16	0.14	0.12	0.10	0.09	0.08																				
For capacitance value >1000µF, add 0.02 per another 1000µF																												
Low Temperature Characteristics	Impedance ratio max. at 120Hz																											
	<table border="1"> <tr> <th>Working Voltage (V)</th> <td>6.3</td> <td>10</td> <td>16</td> <td>25</td> <td>35</td> <td>50</td> <td>63</td> <td>100</td> </tr> <tr> <th>Z-25°C / Z+20°C</th> <td>4</td> <td>3</td> <td>2</td> <td>2</td> <td>2</td> <td>2</td> <td>2</td> <td>2</td> </tr> <tr> <th>Z-40°C / Z+20°C</th> <td>8</td> <td>6</td> <td>4</td> <td>4</td> <td>3</td> <td>3</td> <td>3</td> <td>3</td> </tr> </table>	Working Voltage (V)	6.3	10	16	25	35	50	63	100	Z-25°C / Z+20°C	4	3	2	2	2	2	2	2	Z-40°C / Z+20°C	8	6	4	4	3	3	3	3
	Working Voltage (V)	6.3	10	16	25	35	50	63	100																			
Z-25°C / Z+20°C	4	3	2	2	2	2	2	2																				
Z-40°C / Z+20°C	8	6	4	4	3	3	3	3																				
High Temperature Loading	Test time : 1,000 hours Test temperature : +85°C Test conditions : Rated DC working voltage with rated ripple current																											
	Post test requirements at +20°C Leakage current : ≤ Initial specified value Cap. change : within ±20% of the initial measured value tan δ : ≤ 150% of the initial specified value																											
Shelf Life	At +85°C no voltage applied after 1,000 hours and then being stabilized at +20°C the capacitors shall meet the following limits Leakage current : ≤ Initial specified value Cap. change : within ±20% of the initial measured value tan δ : ≤ 150% of the initial specified value																											
Industrial Standard	JIS C - 5101-4 (IEC 60384-4)																											

CASE SIZE TABLE



φD	5	6.3	8 (L < 20)	8 (L ≥ 20)	10	12.5	16	18
F	2.0	2.5	3.5	3.5	5.0	5.0	7.5	7.5
φd	0.5	0.5	0.5	0.6	0.6	0.6	0.8	0.8
α				(L < 20) 1.5				
β				(D < 20) 0.5				
					(L ≥ 20) 2.0			
					(D ≥ 20) 1.0			

RIPPLE CURRENT MULTIPLIER

Frequency Coefficient

Coefficient	Freq. (Hz)				
Cap (µF)	50	120	300	1k	10k~
≤ 47	0.75	1.00	1.35	1.57	2.00
68-470	0.80	1.00	1.23	1.34	1.50
≥ 560	0.85	1.00	1.10	1.13	1.15

PART NUMBER SYSTEM (EXAMPLE : 25V 220µF)

1	23	456	7	89	10	11 12	13 14
E	FA	227	M	1E	G	16	RR



STANDARD RATINGS

Voltage (Code)		6.3V (0J)		10V (1A)		16V (1C)		25V (1E)	
Cap. (μF)	Code	Case Size	Ripple Current	Case Size	Ripple Current	Case Size	Ripple Current	Case Size	Ripple Current
4.7	475							5 x 11	22
10	106					5 x 11	31	5 x 11	32
22	226	5 x 11	36	5 x 11	41	5 x 11	46	5 x 11	50
33	336	5 x 11	46	5 x 11	51	5 x 11	57	6.3 x 11	70
47	476	5 x 11	55	5 x 11	60	6.3 x 11	74	6.3 x 11	85
100	107	6.3 x 11	88	6.3 x 11	99	8 x 12	128	8 x 12	140
220	227	8 x 12	155	8 x 12	170	10 x 12.5	226	10 x 16	260
330	337	10 x 12.5	226	10 x 12.5	247	10 x 16	309	10 x 20	351
470	477	10 x 12.5	270	10 x 16	330	10 x 20	406	12.5 x 20	476
1000	108	10 x 20	485	12.5 x 20	601	12.5 x 25	723	16 x 25	854
2200	228	12.5 x 25	867	16 x 25	1047	16 x 25	1209	16 x 35	1570
3300	338	16 x 25	1135	16 x 30	1520	16 x 25	1720	18 x 40	1794
4700	478	16 x 30	1431	16 x 35	1840	18 x 35	2140		
6800	688	18 x 35	1810	18 x 40	2049				
10000	109	18 x 40	2100						

Maximum Allowable Ripple Current (mArms) at 85°C 120Hz

Case Size ΦD x L (mm)

Voltage (Code)		35V (1V)		50V (1H)		63V (1J)		100V (2A)	
Cap. (μF)	Code	Case Size	Ripple Current	Case Size	Ripple Current	Case Size	Ripple Current	Case Size	Ripple Current
2.2	225			5 x 11	18			5 x 11	22
3.3	335			5 x 11	22			5 x 11	27
4.7	475	5 x 11	24	5 x 11	27			5 x 11	36
10	106	5 x 11	36	5 x 11	39	6.3 x 11	50	8 x 12	65
22	226	6.3 x 11	60	6.3 x 11	65	8 x 12	85	10 x 12.5	110
33	336	6.3 x 11	75	8 x 12	93	8 x 12	105	10 x 16	150
47	476	8 x 12	101	8 x 12	111	10 x 12.5	140	10 x 20	190
100	107	10 x 12.5	176	10 x 16	215	10 x 20	255	12.5 x 20	300
220	227	10 x 20	320	12.5 x 20	390	12.5 x 20	420	16 x 25	549
330	337	12.5 x 20	446	12.5 x 20	488	12.5 x 25	541	16 x 30	734
470	477	12.5 x 25	590	16 x 25	650	16 x 25	840	18 x 35	980
1000	108	16 x 25	1060	16 x 30	1143	18 x 35	1400		
2200	228	18 x 35	1840						

Maximum Allowable Ripple Current (mArms) at 85°C 120Hz

Case Size ΦD x L (mm)

Specifications are subject to change without notice. Should a safety or technical concern arise regarding the product, please be sure to contact our sales offices or agents immediately.

FEATURES

➤ Standard non-polarized series for entertainment electronics.



SPECIFICATIONS

Item	Performance Characteristics																											
Operating Temperature Range	-40 to +85°C																											
Rated Working Voltage Range	6.3 to 100V																											
Nominal Capacitance Range	2.2 to 6800µF																											
Capacitance Tolerance	±20% at 120Hz, +20°C																											
Leakage Current	I ≤ 0.03CV or 3 (µA) whichever is greater measured after 5 minutes application of rated working voltage at +20°C																											
tan δ (120Hz, +20°C)	<table border="1"> <tr> <td>Working Voltage (V)</td> <td>6.3</td> <td>10</td> <td>16</td> <td>25</td> <td>35</td> <td>50</td> <td>63</td> <td>100</td> </tr> <tr> <td>Tan δ (max.)</td> <td>0.26</td> <td>0.24</td> <td>0.22</td> <td>0.20</td> <td>0.16</td> <td>0.14</td> <td>0.12</td> <td>0.10</td> </tr> </table>	Working Voltage (V)	6.3	10	16	25	35	50	63	100	Tan δ (max.)	0.26	0.24	0.22	0.20	0.16	0.14	0.12	0.10									
	Working Voltage (V)	6.3	10	16	25	35	50	63	100																			
Tan δ (max.)	0.26	0.24	0.22	0.20	0.16	0.14	0.12	0.10																				
For capacitance value >1000µF, add 0.02 per another 1000µF																												
Low Temperature Characteristics	Impedance ratio max. at 120Hz																											
	<table border="1"> <tr> <td>Working Voltage (V)</td> <td>6.3</td> <td>10</td> <td>16</td> <td>25</td> <td>35</td> <td>50</td> <td>63</td> <td>100</td> </tr> <tr> <td>Z-25°C / Z+20°C</td> <td>4</td> <td>3</td> <td>2</td> <td>2</td> <td>2</td> <td>2</td> <td>2</td> <td>2</td> </tr> <tr> <td>Z-40°C / Z+20°C</td> <td>10</td> <td>8</td> <td>6</td> <td>5</td> <td>4</td> <td>4</td> <td>3</td> <td>3</td> </tr> </table>	Working Voltage (V)	6.3	10	16	25	35	50	63	100	Z-25°C / Z+20°C	4	3	2	2	2	2	2	2	Z-40°C / Z+20°C	10	8	6	5	4	4	3	3
	Working Voltage (V)	6.3	10	16	25	35	50	63	100																			
Z-25°C / Z+20°C	4	3	2	2	2	2	2	2																				
Z-40°C / Z+20°C	10	8	6	5	4	4	3	3																				
High Temperature Loading	Test time : 1,000 hours Test temperature : +85°C Test conditions : Rated DC working voltage to each polarity every 250 hours																											
	Post test requirements at +20°C Leakage current : ≤Initial specified value Cap. change : within ±20% of the initial measured value tan δ : ≤200% of the initial specified value																											
Shelf Life	At +85°C no voltage applied after 1,000 hours and then being stabilized at +20°C the capacitors shall meet the following limits Leakage current : ≤Initial specified value Cap. change : within ±20% of the initial measured value tan δ : ≤200% of the initial specified value																											
Industrial Standard	JIS C - 5101-4 (IEC 60384-4)																											

CASE SIZE TABLE



φD	5	6.3	8 (L < 20)	8 (L ≥ 20)	10	12.5	16	18
F	2.0	2.5	3.5	3.5	5.0	5.0	7.5	7.5
φd	0.5	0.5	0.5	0.6	0.6	0.6	0.8	0.8
α				(L < 20) 1.5				
β				(D < 20) 0.5				
					(D ≥ 20) 2.0			
					(D ≥ 20) 1.0			

RIPPLE CURRENT MULTIPLIER

Frequency Coefficient

Coefficient	Cap (µF)	50	120	300	1k	10k~
≤47		0.75	1.00	1.35	1.57	2.00
68~470		0.80	1.00	1.23	1.34	1.50
≥560		0.85	1.00	1.10	1.13	1.15

PART NUMBER SYSTEM (EXAMPLE : 16V 100µF)



NP

Miniature Aluminum Electrolytic Capacitors

STANDARD RATINGS

Voltage (Code)		6.3V (0J)		10V (1A)		16V (1C)		25V (1E)	
Cap. (µF)	Code	Case Size	Ripple Current	Case Size	Ripple Current	Case Size	Ripple Current	Case Size	Ripple Current
4.7	475							5 x 11	26
10	106					5 x 11	42	5 x 11	42
22	226			5 x 11	57	5 x 11	57	6.3 x 11	65
33	336	5 x 11	64	5 x 11	64	5 x 11	70	6.3 x 11	80
47	476	5 x 11	76	5 x 11	76	6.3 x 11	95	6.3 x 11	95
100	107	6.3 x 11	125	6.3 x 11	125	8 x 12	160	8 x 12	160
220	227	8 x 12	215	8 x 12	215	10 x 12.5	275	10 x 16	305
330	337	8 x 12	265	10 x 16	345	10 x 16	375	12.5 x 20	450
470	477	10 x 12.5	370	10 x 16	410	10 x 20	485	12.5 x 20	540
1000	108	10 x 20	650	12.5 x 20	720	12.5 x 25	855	16 x 25	950
2200	228	12.5 x 25	1160	16 x 25	1280	16 x 30	1510	18 x 35	1620
3300	338	16 x 25	1570	16 x 30	1690	18 x 35	1980		
4700	478	16 x 30	2020	18 x 35	2160				
6800	688	18 x 35	2600						

Maximum Allowable Ripple Current (mArms) at 85°C 120Hz

Case Size Φ D x L (mm)

Voltage (Code)		35V (1V)		50V (1H)		63V (1J)		100V (2A)	
Cap. (µF)	Code	Case Size	Ripple Current	Case Size	Ripple Current	Case Size	Ripple Current	Case Size	Ripple Current
2.2	225			5 x 11	25			6.3 x 11	34
3.3	335			5 x 11	27	5 x 11	28	6.3 x 11	39
4.7	475	5 x 11	34	5 x 11	34	6.3 x 11	34	6.3 x 11	47
10	106	5 x 11	43	6.3 x 11	52	6.3 x 11	57	8 x 12	71
22	226	6.3 x 11	73	8 x 12	89	8 x 12	95	10 x 16	135
33	336	8 x 12	100	8 x 12	105	10 x 12.5	135	12.5 x 20	220
47	476	8 x 12	120	10 x 12.5	150	10 x 16	180	12.5 x 20	240
68	686			10 x 16	198				
100	107	10 x 16	230	10 x 20	265	12.5 x 20	320	16 x 25	425
220	227	12.5 x 20	410	12.5 x 25	480	16 x 25	575	18 x 35	720
330	337	12.5 x 20	505	16 x 25	650	16 x 30	655		
470	477	12.5 x 25	655	16 x 30	835	18 x 35	965		
1000	108	16 x 30	1140						

Maximum Allowable Ripple Current (mArms) at 85°C 120Hz

Case Size Φ D x L (mm)

Specifications are subject to change without notice. Should a safety or technical concern arise regarding the product, please be sure to contact our sales offices or agents immediately.

FEATURES

- Nonpolar, high temperature.
- Suitable for use in polarity and change circuits.



SPECIFICATIONS

Item	Performance Characteristics								
Operating Temperature Range	-40 to +105°C								
Rated Working Voltage Range	6.3 to 100V								
Nominal Capacitance Range	2.2 to 1000µF								
Capacitance Tolerance	±20% at 120Hz, +20°C								
Leakage Current	I ≤ 0.03CV or 3 (µA) whichever is greater measured after 5 minutes application of rated working voltage at +20°C								
tan δ (120Hz, +20°C)	Working Voltage (V)	6.3	10	16	25	35	50	63	100
	tan δ (max.)	0.26	0.24	0.22	0.20	0.16	0.14	0.12	0.10
Low Temperature Characteristics	Impedance ratio max. at 120Hz								
	Working Voltage (V)	6.3	10	16	25	35	50	63	100
	Z-25°C / Z+20°C	4	3	2	2	2	2	2	2
High Temperature Loading	Test time	: 1,000 hours			Post test requirements at +20°C				
	Test temperature	: +105°C			Leakage current : ≤ Initial specified value				
	Test conditions	: Rated DC working voltage to each polarity every 250 hours			Cap. change : within ±20% of the initial measured value tan δ : ≤ 200% of the initial specified value				
Shelf Life	At +105°C no voltage applied after 1,000 hours and then being stabilized at +20°C the capacitors shall meet the following limits Leakage current : ≤ Initial specified value Cap. change : within ±20% of the initial measured value tan δ : ≤ 200% of the initial specified value								
Industrial Standard	JIS C - 5101-4 (IEC 60384-4)								

CASE SIZE TABLE

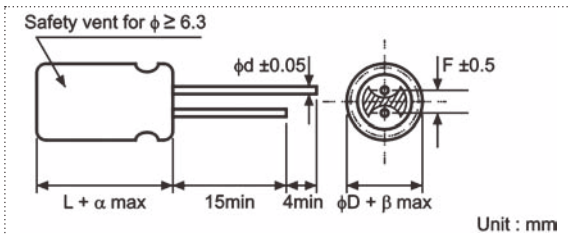

φD	5	6.3	8 (L < 20)	8 (L ≥ 20)	10	12.5	16
F	2.0	2.5	3.5	3.5	5.0	5.0	7.5
φd	0.5	0.5	0.5	0.6	0.6	0.6	0.8
α	(L < 20) 1.5			(L ≥ 20) 2.0			
β	(D < 20) 0.5			(D ≥ 20) 1.0			

RIPPLE CURRENT MULTIPLIER

Frequency Coefficient

Coefficient	Freq. (Hz)	50	120	300	1k	10k~
Cap (µF)	≤ 47	0.75	1.00	1.35	1.57	2.00
	68-220	0.80	1.00	1.23	1.34	1.50
	≥ 560	0.85	1.00	1.10	1.13	1.15

PART NUMBER SYSTEM (EXAMPLE : 10V 47µF)

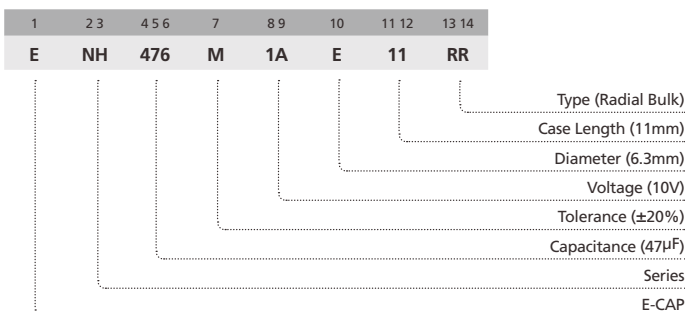

STANDARD RATINGS

Voltage (Code)		6.3V (0J)		10V (1A)		16V (1C)		25V (1E)	
Cap. (µF)	Code	Case Size	Ripple Current	Case Size	Ripple Current	Case Size	Ripple Current	Case Size	Ripple Current
4.7	475							5 x 11	23
10	106					5 x 11	30	5 x 11	34
22	226			5 x 11	42	6.3 x 11	51	6.3 x 11	55
33	336	5 x 11	46	6.3 x 11	57	6.3 x 11	63	8 x 12	79
47	476	6.3 x 11	61	6.3 x 11	67	8 x 12	89	10 x 12.5	100
100	107	8 x 12	104	10 x 12.5	125	10 x 12.5	139	10 x 16	164
220	227	10 x 12.5	168	10 x 16	204	10 x 20	279	12.5 x 25	336
330	337	10 x 16	229	10 x 20	275	12.5 x 20	346	12.5 x 25	414
470	477	10 x 20	330	12.5 x 20	371	12.5 x 25	460	16 x 25	543
1000	108	12.5 x 25	550	16 x 25	668	16 x 25	746	16 x 30	871

Maximum Allowable Ripple Current (mArms) at 105°C 120Hz

Case Size Φ D x L (mm)

Voltage (Code)		35V (1V)		50V (1H)		63V (1J)		100V (2A)	
Cap. (µF)	Code	Case Size	Ripple Current	Case Size	Ripple Current	Case Size	Ripple Current	Case Size	Ripple Current
2.2	225			5 x 11	18			6.3 x 11	22
3.3	335			5 x 11	22	6.3 x 11	26	8 x 12	32
4.7	475	5 x 11	25	6.3 x 11	29	6.3 x 11	31	8 x 12	39
10	106	6.3 x 11	40	8 x 12	51	8 x 12	53	10 x 12.5	64
22	226	8 x 12	68	10 x 12.5	82	10 x 16	96	10 x 20	114
33	336	10 x 12.5	89	10 x 16	107	10 x 20	129	12.5 x 20	164
47	476	10 x 12.5	111	10 x 20	146	10 x 20	157	12.5 x 25	200
100	107	10 x 20	196	12.5 x 25	264	12.5 x 25	275	16 x 25	304
220	227	12.5 x 25	364	16 x 25	443	16 x 30	486		
330	337	16 x 25	493	16 x 30	593				
470	477	16 x 25	586						

Maximum Allowable Ripple Current (mArms) at 105°C 120Hz

Case Size Φ D x L (mm)

Specifications are subject to change without notice. Should a safety or technical concern arise regarding the product, please be sure to contact our sales offices or agents immediately.

FEATURES

- 105°C high temperature and high voltage, load life : 2,000 hours.
- For slim size adaptor, LCD / LED-TV and LCD-Monitor power.



SPECIFICATIONS

Item	Performance Characteristics						
Operating Temperature Range	-25 to +105°C						
Rated Working Voltage Range	200 to 450V						
Nominal Capacitance Range	22 to 270μF						
Capacitance Tolerance	±20% at 120Hz, +20°C						
Leakage Current	I ≤ 0.03CV + 40 (μA) after 2 minutes application of rated working voltage at +20°C						
tan δ (120Hz, +20°C)	Working Voltage (V)	200	220	250	400	420	450
	tan δ (max.)	0.20	0.20	0.20	0.24	0.24	0.24
Low Temperature Characteristics	Impedance ratio max. at 120Hz						
	Rated Voltage (V) Z-25°C / Z+20°C	200	220	250	400	420	450
High Temperature Loading	Test time	: 2,000 hours			Post test requirements at +20°C		
	Test temperature	: +105°C			Leakage current : ≤ Initial specified value		
	Test conditions	: Rated DC working voltage with rated ripple current			Cap. change : within ±20% of the initial measured value		
					tan δ : ≤ 200% of the initial specified value		
Shelf Life	At +105°C no voltage applied after 1,000 hours and then being stabilized at +20°C the capacitors shall meet the following limits						
	Leakage current : ≤ Initial specified value						
	Cap. change : within ±20% of the initial measured value						
	tan δ : ≤ 200% of the initial specified value						
Industrial Standard	JIS C - 5101-4 (IEC 60384-4)						

CASE SIZE TABLE



φD	10	12.5
F	5.0	5.0
φd	0.6	0.6
α	2.0	
β	1.0	

RIPPLE CURRENT MULTIPLIER

Frequency Coefficient

Coefficient	Freq. (Hz)	50	120	300	1k	10k~
Rated Voltage	200-450V	0.80	1.00	1.25	1.40	1.60

PART NUMBER SYSTEM (EXAMPLE : 200V 220μF)

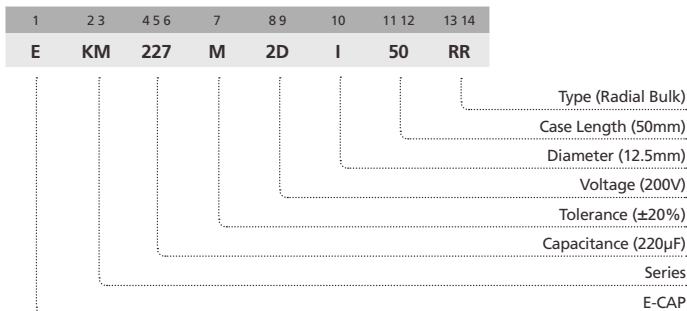

STANDARD RATINGS

Voltage (Code)		200V (2D)		220V (2N)		250V (2E)	
Cap. (μF)	Code	Case Size	Ripple Current	Case Size	Ripple Current	Case Size	Ripple Current
82	826					10 x 45	390
100	107	10 x 40	410	10 x 45	420	10 x 50	430
						12.5 x 35	440
120	127	10 x 45	425	10 x 50	480	12.5 x 40	505
		10 x 55	500				
150	157	12.5 x 35	495	12.5 x 40	550	12.5 x 45	585
180	187	12.5 x 40	560	12.5 x 45	630	12.5 x 55	625
220	227	12.5 x 50	640	12.5 x 55	690		
270	277	12.5 x 60	695				

Maximum Allowable Ripple Current (mArms) at 105°C 120Hz

Case Size ΦD x L (mm)

Voltage (Code)		400V (2G)		420V (2M)		450V (2W)	
Cap. (μF)	Code	Case Size	Ripple Current	Case Size	Ripple Current	Case Size	Ripple Current
22	226					10 x 35	135
27	276					10 x 40	165
33	336	10 x 40	245	10 x 40	215	10 x 45	200
39	396	10 x 45	320	10 x 45	245	10 x 50	245
						12.5 x 35	255
47	476	10 x 50	360	10 x 55	295	10 x 60	300
		12.5 x 35	350	12.5 x 35	285	12.5 x 40	305
56	566	10 x 60	415				
		12.5 x 40	400	12.5 x 40	345	12.5 x 45	350
68	686	12.5 x 45	465	12.5 x 50	400	12.5 x 50	390
82	826	12.5 x 55	500	12.5 x 55	455	12.5 x 60	440
100	107	12.5 x 60	520				

Maximum Allowable Ripple Current (mArms) at 105°C 120Hz

Case Size ΦD x L (mm)

Specifications are subject to change without notice. Should a safety or technical concern arise regarding the product, please be sure to contact our sales offices or agents immediately.

FEATURES

- 105°C high temperature and high voltage, load life : 5,000 hours.
- For slim size adaptor, LCD / LED-TV and LCD-Monitor power.



SPECIFICATIONS

Item	Performance Characteristics						
Operating Temperature Range	-25 to +105°C						
Rated Working Voltage Range	200 to 450V						
Nominal Capacitance Range	22 to 220μF						
Capacitance Tolerance	±20% at 120Hz, +20°C						
Leakage Current	$I \leq 0.02CV + 25 (\mu A)$ after 2 minutes application of rated working voltage at +20°C						
tan δ (120Hz, +20°C)	Working Voltage (V)	200	220	250	400	420	450
	tan δ (max.)	0.20	0.20	0.20	0.24	0.24	0.24
Low Temperature Characteristics	Impedance ratio max. at 120Hz						
	Rated Voltage (V) Z-25°C / Z+20°C	200	220	250	400	420	450
High Temperature Loading	Test time : 5,000 hours	Post test requirements at +20°C					
	Test temperature : +105°C Test conditions : Rated DC working voltage with rated ripple current	Leakage current : ≤Initial specified value Cap. change : within ±20% of the initial measured value tan δ : ≤200% of the initial specified value					
Shelf Life	At +105°C no voltage applied after 1,000 hours and then being stabilized at +20°C the capacitors shall meet the following limits Leakage current : ≤Initial specified value Cap. change : within ±20% of the initial measured value tan δ : ≤200% of the initial specified value						
Industrial Standard	JIS C - 5101-4 (IEC 60384-4)						

CASE SIZE TABLE



φD	10	12.5
F	5.0	5.0
φd	0.6	0.6
α	2.0	
β	1.0	

RIPPLE CURRENT MULTIPLIER

Frequency Coefficient

Coefficient	Freq. (Hz)	50	120	300	1k	10k~
Rated Voltage	200~450V	0.80	1.00	1.25	1.40	1.60

PART NUMBER SYSTEM (EXAMPLE : 250V 150μF)

1	23	456	7	89	10	11 12	13 14
E	RW	157	M	2E	I	50	RR



STANDARD RATINGS

Voltage (Code)		200V (2D)		220V (2N)		250V (2E)	
Cap. (μF)	Code	Case Size	Ripple Current	Case Size	Ripple Current	Case Size	Ripple Current
82	826					10 x 45	390
100	107	10 x 45	420	10 x 45	420	10 x 55 12.5 x 35	440
120	127	10 x 50	435	10 x 55	490	12.5 x 40	505
150	157	10 x 60 12.5 x 40	500	12.5 x 40	550	12.5 x 50	590
180	187	12.5 x 45	580	12.5 x 45	630	12.5 x 55	625
220	227	12.5 x 55	650	12.5 x 55	690		

Maximum Allowable Ripple Current (mArms) at 105°C 120Hz

Case Size ΦD x L (mm)

Voltage (Code)		400V (2G)		420V (2M)		450V (2W)	
Cap. (μF)	Code	Case Size	Ripple Current	Case Size	Ripple Current	Case Size	Ripple Current
22	226					10 x 35	135
27	276					10 x 40	165
33	336	10 x 40	245	10 x 45	220	10 x 45	200
39	396	10 x 45	320	10 x 50 12.5 x 35	245	10 x 55 12.5 x 35	255
47	476	10 x 55 12.5 x 35	360	10 x 60 12.5 x 35	295	12.5 x 40	305
56	566	12.5 x 40	400	12.5 x 40	345	12.5 x 45	350
68	686	12.5 x 45	465	12.5 x 50	400	12.5 x 55	400
82	826	12.5 x 55	500	12.5 x 60	460	12.5 x 51	420

Maximum Allowable Ripple Current (mArms) at 105°C 120Hz

Case Size ΦD x L (mm)

Specifications are subject to change without notice. Should a safety or technical concern arise regarding the product, please be sure to contact our sales offices or agents immediately.

FEATURES

- 105°C high temperature and high voltage, load life : 10,000 hours.
- For slim size adaptor, LCD / LED-TV and LCD-Monitor power.



SPECIFICATIONS

Item	Performance Characteristics						
Operating Temperature Range	-25 to +105°C						
Rated Working Voltage Range	200 to 450V						
Nominal Capacitance Range	22 to 220μF						
Capacitance Tolerance	±20% at 120Hz, +20°C						
Leakage Current	I ≤ 0.02CV + 25 (μA) after 2 minutes application of rated working voltage at +20°C						
tan δ (120Hz, +20°C)	Working Voltage (V)	200	220	250	400	420	450
	tan δ (max.)	0.20	0.20	0.20	0.24	0.24	0.24
Low Temperature Characteristics	Impedance ratio max. at 120Hz						
	Rated Voltage (V)	200	220	250	400	420	450
High Temperature Loading	Z-25°C / Z+20°C	4	4	6	8	8	15
	Test time : 10,000 hours Test temperature : +105°C Test conditions : Rated DC working voltage with rated ripple current	Post test requirements at +20°C Leakage current : ≤ Initial specified value Cap. change : within ±20% of the initial measured value tan δ : ≤ 200% of the initial specified value					
Shelf Life	At +105°C no voltage applied after 1,000 hours and then being stabilized at +20°C the capacitors shall meet the following limits Leakage current : ≤ Initial specified value Cap. change : within ±20% of the initial measured value tan δ : ≤ 200% of the initial specified value						
Industrial Standard	JIS C - 5101-4 (IEC 60384-4)						

CASE SIZE TABLE



ΦD	10	12.5
F	5.0	5.0
Φd	0.6	0.6
α	2.0	
β	1.0	

RIPPLE CURRENT MULTIPLIER

Frequency Coefficient

Coefficient	50	120	300	1K	10k~
Rated Voltage	0.80	1.00	1.25	1.40	1.60

PART NUMBER SYSTEM (EXAMPLE : 250V 150μF)

1	23	456	7	89	10	1112	1314
E	RY	157	M	2E	I	50	RR
Type (Radial Bulk)							
Case Length (50mm)							
Diameter (12.5mm)							
Voltage (250V)							
Tolerance (±20%)							
Capacitance (150μF)							
Series							
E-CAP							

STANDARD RATINGS

Voltage (Code)		200V (2D)		220V (2N)		250V (2E)	
Cap. (μF)	Code	Case Size	Ripple Current	Case Size	Ripple Current	Case Size	Ripple Current
82	826					10 x 45	390
100	107	10 x 45	420	10 x 45	430	10 x 55 12.5 x 35	440
120	127	10 x 50	435	10 x 55	490	12.5 x 40	505
150	157	10 x 60 12.5 x 40	500	12.5 x 40	550	12.5 x 50	590
180	187	12.5 x 45	580	12.5 x 50	640	12.5 x 55	625
220	227	12.5 x 55	650	12.5 x 60	700		

Maximum Allowable Ripple Current (mArms) at 105°C 120Hz

Case Size ΦD x L (mm)

Voltage (Code)		400V (2G)		420V (2M)		450V (2W)	
Cap. (μF)	Code	Case Size	Ripple Current	Case Size	Ripple Current	Case Size	Ripple Current
22	226					10 x 40	145
27	276					10 x 45	175
33	336	10 x 40	245	10 x 45	220	10 x 50 12.5 x 35	210 220
39	396	10 x 45	320	10 x 50 12.5 x 35	245	10 x 60 12.5 x 40	260
47	476	10 x 55 12.5 x 35	360	10 x 60 12.5 x 35	295	12.5 x 45	315
56	566	12.5 x 40	400	12.5 x 45	355	12.5 x 50	365
68	686	12.5 x 45	465	12.5 x 50	400	12.5 x 60	410
82	826	12.5 x 55	500	12.5 x 60	460		

Maximum Allowable Ripple Current (mArms) at 105°C 120Hz

Case Size ΦD x L (mm)

Specifications are subject to change without notice. Should a safety or technical concern arise regarding the product, please be sure to contact our sales offices or agents immediately.

CASE SIZE TABLE

SW-Type

$\phi D = \phi 20 \sim \phi 40$

PC Board Mounting Holes

Unit : mm

SZ-Type

$\phi D = \phi 20 \sim \phi 40$

PC Board Mounting Holes

Unit : mm

SG-Type

ϕD	35	40	50	63	76
P	14	14	18	25	25

PC Board Mounting Holes

Unit : mm

SX-Type

$\phi D = \phi 35 \sim \phi 50$

PC Board Mounting Holes

Unit : mm

LD-Type

$\phi D = \phi 30 \sim \phi 40$

PC Board Mounting Holes

Unit : mm

ST-Type

$\phi D = \phi 25 \sim \phi 35$

PC Board Mounting Holes

Unit : mm

CASE SIZE TABLE

FE-Type

Unit : mm

VO-Type

D	h	a
20	10	10
30	10	10
35	10	10
40	10	20
50	10	20

Unit : mm

VO-Type
成品带螺柱

D	h	a	B
20	10	10	M8 x 12
30	10	10	M8 x 12
35	10	10	M8 x 12
40	10	20	M8 x 12
50	10	20	M12 x 16

Unit : mm

	thread	max. tightening torque
mounting	M8	4 Nm
mounting	M12	10 Nm

FEATURES

- Directly mountable on printed circuit board without holders.
- Smaller in sizes than ordinary capacitors.
- Terminal spacing fixed at 10mm for PC board plug in.
- Aluminum case designed with explosion-proof vent.



SPECIFICATIONS

Item	Performance Characteristics	
Operating Temperature Range	-40 to +85°C	-25 to +85°C
Rated Working Voltage Range	10 to 250V	315 to 500V
Nominal Capacitance Range	56 to 82000µF	
Capacitance Tolerance	±20% at 120Hz, +20°C	
Leakage Current	I ≤ 3√CV (µA) after 5 minutes application of rated working voltage at +20°C	
tan δ (120Hz, +20°C)	Working Voltage (V)	10 16 25 35 50 63 80 100
	tan δ (max.)	0.55 0.50 0.45 0.40 0.35 0.30 0.25 0.20
	Working Voltage (V)	160~250 315~420 450~500
	tan δ (max.)	0.15 0.15 0.20
	For capacitance value >33000µF, add following calculated value: $\frac{(\text{rated capacitance}) - 33000\mu\text{F}}{10000\mu\text{F}} \times 0.1$	
Low Temperature Characteristics	Impedance ratio max. at 120Hz	
	Working Voltage (V)	10~100 160~250 315~385 400~450 500
	Z-25°C / Z+20°C	4 3 5 8 8
	Z-40°C / Z+20°C	15 15 - - -
High Temperature Loading	Test time : 2,000 hours	Post test requirements at +20°C
	Test temperature : +85°C	Leakage current : ≤ Initial specified value
	Test conditions : Rated DC working voltage with rated ripple current	Cap. change : within ±20% of the initial measured value
		tan δ : ≤200% of the initial specified value
Shelf Life	At +85°C no voltage applied after 1,000 hours and then being stabilized at +20°C the capacitors shall meet the following limits	
	Leakage current : ≤ Initial specified value	
	Cap. change : within ±15% of the initial measured value	
	tan δ : ≤150% of the initial specified value	
Industrial Standard	JIS C - 5101-4 (IEC 60384-4)	

RIPPLE CURRENT MULTIPLIER

Frequency Coefficient

Coefficient	Freq. (Hz)	Rated Voltage			
		60	120	1k	10k~50k
0.90	10~100V	0.90	1.00	1.15	1.25
	160~250V	0.80	1.00	1.15	1.47
	315~500V	0.80	1.00	1.15	1.47

PART NUMBER SYSTEM (EXAMPLE : 250V 330µF)

1	2 3	4 5 6	7	8 9	10	11 12	13 14	
E	LP	337	M	2E	N	30	SW	

Type (Terminal Code)
 Case Length (30mm)
 Diameter (22mm)
 Voltage (250V)
 Tolerance (±20%)
 Capacitance (330µF)
 Series
 E-CAP

STANDARD RATINGS

Voltage (Code)		10V (1A)		16V (1C)		25V (1E)		35V (1V)					
Cap. (μF)	Code	Case Size	Ripple Current	Case Size	Ripple Current	Case Size	Ripple Current	Case Size	Ripple Current				
2700	278							20 x 25	1.76				
3300	338							20 x 30	2.14				
3900	398							20 x 30	2.28				
4700	478					20 x 25	2.18	22 x 25	2.22				
								20 x 35	2.46				
								22 x 30	2.46				
5600	568					20 x 30	2.33	25 x 25	2.43				
								22 x 35	2.79				
								25 x 30	2.75				
6800	688			20 x 25	2.33	20 x 35	2.56	22 x 40	2.97				
										25 x 30	2.89		
										30 x 25	3.09		
8200	828			20 x 30	2.56	20 x 40	2.91	22 x 45	3.47				
										25 x 35	3.33		
										22 x 30	2.86		
10000	109	20 x 25	2.22	20 x 35	2.85	22 x 35	3.31	25 x 35	3.29				
												30 x 30	3.29
												22 x 50	3.75
12000	129	20 x 30	2.44	22 x 30	2.89	25 x 30	3.16	25 x 40	3.65				
												30 x 30	3.61
												20 x 40	3.20
15000	159	22 x 25	2.41	22 x 30	3.13	22 x 40	3.77	25 x 45	4.15				
												30 x 35	4.14
												25 x 25	3.01
18000	189	20 x 35	2.90	30 x 25	3.73	30 x 25	3.80	35 x 30	4.27				
												22 x 35	3.69
												22 x 50	4.21
22000	229	22 x 30	2.88	25 x 30	3.64	25 x 40	4.10	30 x 40	4.80				
												35 x 35	4.95
												30 x 30	4.00
27000	279	25 x 25	2.88	30 x 25	3.73	30 x 30	4.00	35 x 35	4.95				
												20 x 40	3.98
												25 x 45	4.68
33000	339	20 x 40	3.31	22 x 40	3.98	25 x 45	4.68	30 x 45	5.30				
												30 x 35	4.66
												35 x 30	4.68
39000	399	22 x 40	3.79	22 x 50	4.52	30 x 40	5.33	35 x 40	5.71				
												25 x 30	3.66
												25 x 40	4.44
47000	479	25 x 30	3.66	30 x 30	4.38	35 x 35	5.26	35 x 45	6.38				
												22 x 45	4.04
												25 x 45	4.98
56000	569	25 x 35	4.04	30 x 35	4.95	30 x 45	6.02	35 x 50	6.90				
												30 x 30	3.99
												35 x 40	6.02
68000	689	22 x 50	4.58	25 x 50	5.49	35 x 45	6.75						
												25 x 40	4.56
												30 x 40	5.60
82000	829	30 x 30	4.58	35 x 30	5.46	35 x 45	6.75						
												25 x 45	5.29
												30 x 45	6.21
39000	399	30 x 35	5.21	35 x 35	6.12	35 x 50	7.56						
												35 x 30	5.50
												25 x 50	5.78
47000	479	30 x 40	5.78	30 x 50	6.93								
												30 x 40	5.78
												35 x 40	6.89
56000	569	35 x 35	6.40	35 x 45	7.69								
												30 x 45	6.59
												35 x 35	6.40
68000	689	30 x 50	7.50										
												30 x 50	7.50
												35 x 40	7.48
82000	829	35 x 50	8.50										
												35 x 50	8.50

Maximum Allowable Ripple Current (Arms) at 85°C 120Hz

Case Size ΦD x L (mm)

Specifications are subject to change without notice. Should a safety or technical concern arise regarding the product, please be sure to contact our sales offices or agents immediately.

STANDARD RATINGS

Voltage (Code)		50V (1H)		63V (1J)		80V (1K)		100V (2A)	
Cap. (μF)	Code	Case Size	Ripple Current	Case Size	Ripple Current	Case Size	Ripple Current	Case Size	Ripple Current
680	687							20 x 25	1.66
820	827							20 x 30	1.85
								22 x 25	1.86
1000	108					20 x 25	1.56	20 x 35	2.02
								22 x 30	2.02
1200	128					20 x 30	1.80	20 x 40	2.12
								22 x 30	2.12
1500	158					22 x 25	1.77	25 x 25	2.11
						20 x 35	2.10	22 x 35	2.45
1800	188			20 x 25	1.69	22 x 30	2.01	25 x 30	2.47
				20 x 30	2.04	20 x 40	2.30	22 x 40	2.77
2200	228	20 x 25	1.70	22 x 25	1.90	22 x 30	2.11	25 x 35	2.81
						25 x 25	2.26	30 x 25	2.65
2700	278	20 x 30	2.07	20 x 35	2.40	22 x 40	2.53	22 x 45	3.15
						22 x 30	2.35	25 x 30	2.53
3300	338	22 x 25	1.93	25 x 25	2.30	30 x 25	2.56	30 x 30	3.17
						20 x 35	2.52	22 x 45	2.93
3900	398	20 x 35	2.21	20 x 40	2.52	22 x 45	2.93	25 x 45	3.66
						22 x 30	2.21	25 x 35	2.93
4700	478			25 x 30	2.52	30 x 30	2.91	30 x 35	3.65
				20 x 40	2.41	22 x 40	2.72	22 x 50	3.23
5600	568	22 x 30	2.41	25 x 30	2.74	25 x 40	3.29	25 x 50	4.15
				25 x 25	2.38	30 x 25	2.78	25 x 40	3.29
6800	688					30 x 30	3.25	30 x 40	4.18
				22 x 35	2.72	22 x 45	3.09	30 x 30	3.25
8200	828	25 x 30	2.68	25 x 35	3.13	25 x 45	3.62	35 x 35	4.07
				30 x 30	3.09	30 x 35	3.70	30 x 45	4.67
10000	109	22 x 40	3.02	22 x 50	3.69	25 x 50	4.28	35 x 35	4.61
				25 x 30	3.07	25 x 40	3.59	25 x 50	4.28
12000	129	30 x 25	3.01	30 x 30	3.54	30 x 40	4.23	30 x 50	5.26
				22 x 45	3.43	25 x 45	4.01	35 x 30	4.12
15000	159	25 x 35	3.47	30 x 35	4.00	35 x 30	4.12	35 x 40	5.23
				30 x 30	3.43	35 x 30	3.75	30 x 45	4.70
18000	189	30 x 40	5.08	30 x 50	5.78	35 x 35	4.64	35 x 45	5.88
				22 x 50	3.94	25 x 50	4.52	35 x 35	4.64
20000	209	25 x 40	3.87	30 x 40	4.55	30 x 50	5.27	35 x 50	6.01
				30 x 35	3.93	35 x 30	4.44	35 x 40	5.24
22000	229	25 x 45	4.44	30 x 45	5.12				
				30 x 35	4.47	35 x 45	5.89		
24000	249	35 x 30	4.41	35 x 35	5.05				
				30 x 40	5.08	30 x 50	5.78		
26000	269	35 x 35	4.92	35 x 40	5.75	35 x 50	6.63		
				30 x 50	5.72				
28000	289	35 x 40	5.69	35 x 45	6.47				
				35 x 45	6.56				
		35 x 50	7.14						

Maximum Allowable Ripple Current (Arms) at 85°C 120Hz

Case Size ΦD x L (mm)

Specifications are subject to change without notice. Should a safety or technical concern arise regarding the product, please be sure to contact our sales offices or agents immediately.

STANDARD RATINGS

Voltage (Code)		160V (2C)		180V (2P)		200V (2D)		220V (2N)	
Cap. (µF)	Code	Case Size	Ripple Current	Case Size	Ripple Current	Case Size	Ripple Current	Case Size	Ripple Current
180	187							20 x 25	1.11
220	227					20 x 25	1.19	20 x 25 22 x 25	1.23 1.30
270	277	20 x 25	1.28	20 x 25	1.29	20 x 30 22 x 25	1.39 1.37	20 x 30 22 x 25	1.46 1.42
330	337	20 x 25	1.55	20 x 30 22 x 25	1.77 1.49	20 x 30 22 x 25	1.56 1.51	20 x 35 22 x 30 25 x 25	1.64 1.59 1.59
390	397	20 x 30 22 x 25	1.63 1.63	20 x 30 22 x 25	1.84 1.84	20 x 35 22 x 30 25 x 25	1.74 1.73 1.71	20 x 40 22 x 35 25 x 25	1.79 1.80 1.75
470	477	20 x 35 22 x 30 25 x 25	1.90 1.86 1.86	20 x 35 22 x 30 25 x 25	1.91 1.91 2.08	20 x 40 22 x 30 25 x 30	2.03 1.97 1.95	22 x 35 25 x 30 30 x 25	2.06 2.08 2.16
560	567	20 x 40 22 x 30 25 x 30	2.14 2.15 2.15	20 x 40 22 x 35 25 x 25	2.15 2.25 2.25	22 x 40 25 x 30 30 x 25	2.18 2.15 2.15	22 x 40 25 x 35 30 x 25	2.22 2.38 2.18
680	687	22 x 40 25 x 30 30 x 25	2.35 2.33 2.33	22 x 35 25 x 30 30 x 25	2.48 2.50 2.46	22 x 45 25 x 35 30 x 30	2.48 2.48 2.48	22 x 45 25 x 40 30 x 30	2.62 2.56 2.52
820	827	22 x 45 25 x 35 30 x 30	2.68 2.65 2.64	22 x 40 25 x 35 30 x 25	2.86 2.75 2.69	22 x 50 25 x 40 30 x 30	2.81 2.79 2.75	25 x 45 30 x 35 35 x 30	2.91 2.84 2.79
1000	108	22 x 50 25 x 40 30 x 30	3.02 3.00 2.96	25 x 40 30 x 30	3.06 3.10	25 x 45 30 x 35 35 x 30	3.28 3.15 3.25	25 x 50 30 x 40 35 x 30	3.53 3.36 3.29
1200	128	25 x 45 30 x 35 35 x 30	3.43 3.41 3.40	25 x 45 30 x 35 35 x 30	3.63 3.55 3.49	25 x 50 30 x 40 35 x 35	3.61 3.61 3.57	30 x 45 35 x 35	3.72 3.68
1500	158	30 x 40 35 x 35	3.96 3.94	30 x 40 35 x 35	4.10 4.02	30 x 45 35 x 40	4.13 4.06	35 x 40	4.10
1800	188	30 x 45 35 x 35	4.31 4.28	30 x 45 35 x 35	4.55 4.54	35 x 45	4.59	35 x 45	4.52
2200	228	35 x 40	4.96	35 x 40	4.83	35 x 50	5.25		
2700	278	35 x 50	5.57	35 x 50	5.30				

Maximum Allowable Ripple Current (Arms) at 85°C 120Hz

Case Size Φ D x L (mm)

STANDARD RATINGS

Voltage (Code)		250V (2E)		315V (2F)		350V (2V)		385V (2Y)	
Cap. (μF)	Code	Case Size	Ripple Current	Case Size	Ripple Current	Case Size	Ripple Current	Case Size	Ripple Current
68	686							20 x 25	0.68
82	826							20 x 30	0.74
								22 x 25	0.76
100	107							20 x 30	0.86
								22 x 30	0.89
120	127					20 x 30	0.96	20 x 35	0.96
						22 x 25	1.04	25 x 25	1.02
150	157			20 x 30	1.00	20 x 30	1.10	20 x 40	1.10
						22 x 30	1.20	22 x 35	1.12
						25 x 25	1.22	25 x 30	1.14
180	187	20 x 25	1.20	20 x 35	1.13	20 x 35	1.24	22 x 40	1.27
				22 x 30	1.29	22 x 30	1.34	25 x 35	1.30
				25 x 25	1.38	25 x 25	1.37	30 x 25	1.37
220	227	20 x 30	1.26	20 x 40	1.29	22 x 35	1.47	22 x 45	1.42
				22 x 35	1.41	25 x 30	1.53	25 x 35	1.48
		22 x 25	1.24	25 x 30	1.47	30 x 25	1.54	30 x 30	1.49
270	277	20 x 30	1.42	22 x 40	1.70	22 x 40	1.70	25 x 40	1.61
				25 x 35	1.73	25 x 35	1.73	30 x 35	16.4
		22 x 30	1.50	25 x 30	1.70	30 x 25	1.80	30 x 35	16.4
330	337	20 x 35	1.68	22 x 45	1.91	22 x 45	1.87	25 x 50	1.80
		22 x 30	1.66	25 x 35	1.94	25 x 40	1.97	30 x 40	1.85
		25 x 25	1.61	30 x 30	1.98	30 x 30	2.03	35 x 30	1.87
390	397	20 x 40	1.92	22 x 50	2.07	25 x 40	2.14	30 x 40	2.05
		22 x 35	1.88	25 x 40	2.11	30 x 35	2.23	35 x 35	2.07
		25 x 30	1.88	30 x 30	2.15	35 x 30	2.30	35 x 35	2.07
470	477	22 x 40	2.15	25 x 45	2.39	30 x 35	2.53	30 x 50	2.26
		25 x 35	2.15	30 x 35	2.38	35 x 30	2.55	35 x 40	2.26
		30 x 25	2.04	35 x 30	2.36	35 x 30	2.55	35 x 40	2.26
560	567	22 x 45	2.48	30 x 40	2.63	30 x 40	2.73	35 x 45	2.59
		25 x 35	2.35	35 x 35	2.69	35 x 35	2.75	35 x 45	2.59
		30 x 30	2.35	35 x 35	2.69	35 x 35	2.75	35 x 45	2.59
680	687	25 x 40	2.67	30 x 45	2.80	35 x 40	3.15	35 x 50	2.80
		30 x 35	2.71	35 x 40	3.05	35 x 40	3.15	35 x 50	2.80
820	827	25 x 50	3.01	30 x 50	3.28	35 x 45	3.47		
		30 x 35	2.98	35 x 45	3.45	35 x 45	3.47		
		35 x 30	2.96	35 x 45	3.45	35 x 45	3.47		
1000	108	30 x 45	3.56	35 x 50	3.57	35 x 50	3.60		
		35 x 35	3.48	35 x 50	3.57	35 x 50	3.60		
1200	128	30 x 50	3.99						
		35 x 40	3.84						
1500	158	35 x 45	4.33						
1800	188	35 x 50	4.54						

Maximum Allowable Ripple Current (Arms) at 85°C 120Hz

Case Size ΦD x L (mm)

Specifications are subject to change without notice. Should a safety or technical concern arise regarding the product, please be sure to contact our sales offices or agents immediately.

STANDARD RATINGS

Voltage (Code)		400V (2G)		420V (2M)		450V (2W)		500V (2H)					
Cap. (μF)	Code	Case Size	Ripple Current	Case Size	Ripple Current	Case Size	Ripple Current	Case Size	Ripple Current				
56	566					20 x 25	0.61						
68	686	20 x 25	0.75	20 x 25	0.70	20 x 30	0.70						
						22 x 25	0.71						
						20 x 30	0.82	20 x 30	0.80	20 x 35	0.80		
82	826	22 x 25	0.84	22 x 25	0.85	22 x 25	0.86						
						20 x 30	0.95	20 x 35	0.90	20 x 35	0.88	25 x 25	0.80
						22 x 30	0.99	22 x 30	0.97	22 x 30	0.95	30 x 25	0.90
100	107	25 x 25	0.99	25 x 25	0.98	25 x 25	0.97	25 x 25	0.97				
						20 x 35	1.07	20 x 35	1.04	20 x 40	0.99	25 x 30	0.89
						22 x 30	1.09	22 x 30	1.07	22 x 35	1.07		
120	127	25 x 30	1.13	25 x 25	1.08	30 x 25	1.12	30 x 25	0.90				
						20 x 40	1.22	20 x 45	1.17	22 x 40	1.18		
						22 x 35	1.24	22 x 35	1.21	25 x 30	1.25	25 x 35	1.07
150	157	25 x 30	1.27	30 x 25	1.30	30 x 25	1.29	30 x 25	1.29				
						22 x 40	1.41	22 x 40	1.33	22 x 45	1.32		
						25 x 30	1.44	25 x 35	1.42	25 x 35	1.40	30 x 35	1.30
180	187	30 x 25	1.52	30 x 25	1.48	30 x 30	1.45						
						22 x 45	1.58	22 x 45	1.55	25 x 40	1.59		
						25 x 35	1.64	25 x 35	1.58	30 x 30	1.64	25 x 45	1.40
220	227	30 x 30	1.66	30 x 30	1.65	35 x 30	1.66						
						25 x 40	1.79	25 x 40	1.74	25 x 45	1.73	25 x 50	1.60
						30 x 30	1.82	30 x 35	1.90	30 x 35	1.89	30 x 40	1.55
270	277	35 x 30	1.94	35 x 30	1.94	35 x 30	1.90						
						25 x 45	2.00	25 x 50	2.20	30 x 40	2.12		
						30 x 35	2.05	30 x 35	1.98	35 x 35	2.15	30 x 45	1.80
330	337	35 x 35	2.17	35 x 35	2.17	35 x 35	2.15						
						30 x 40	2.26	30 x 40	2.22	30 x 45	2.35		
						35 x 35	2.28	35 x 35	2.27	35 x 40	2.38	30 x 50	2.10
390	397	35 x 40	2.51	35 x 40	2.61	35 x 40	2.61						
						30 x 45	2.55	30 x 45	2.50	35 x 45	2.68		
						35 x 40	2.54	35 x 40	2.61				
470	477												
560	567	35 x 40	2.85	35 x 45	2.95								
680	687	35 x 50	3.10										

Maximum Allowable Ripple Current (Arms) at 85°C 120Hz

Case Size ΦD x L (mm)

FEATURES

- Designed for high grade audio equipment, giving priority to high fidelity sound quality.
- Suitable for use in mini-compos, CD, DAT players, cassette decks and etc.



SPECIFICATIONS

Item	Performance Characteristics			
Operating Temperature Range	-40 to +85°C			
Rated Working Voltage Range	16 to 100V			
Nominal Capacitance Range	680 to 10000µF			
Capacitance Tolerance	±20% at 120Hz, +20°C			
Leakage Current	$I \leq 3\sqrt{CV}$ (µA) after 5 minutes application of rated working voltage at +20°C			
tan δ (120Hz, +20°C)	Working Voltage (V)	16	25~63	80~100
	tan δ (max.)	0.30	0.25	0.22
Low Temperature Characteristics	Impedance ratio max. at 120Hz			
	Working Voltage (V)	16~100		
	Z-25°C / Z+20°C	4		
	Z-40°C / Z+20°C	15		
High Temperature Loading	Test time : 1,000 hours	Post test requirements at +20°C		
	Test temperature : +85°C Test condition : Rated DC working voltage with rated ripple current	Leakage current : ≤Initial specified value Cap. change : within ±20% of the initial measured value tan δ : ≤200% of the initial specified value		
Shelf Life	At +85°C no voltage applied after 1,000 hours and then being stabilized at +20°C the capacitors shall meet the following limits Leakage current : ≤Initial specified value Cap. change : within ±20% of the initial measured value tan δ : ≤200% of the initial specified value			
Industrial Standard	JIS C - 5101-4 (IEC 60384-4)			

RIPPLE CURRENT MULTIPLIER

Frequency Coefficient

Coefficient	Freq. (Hz)			
	60	120	1k	10k~50k
Rated Voltage				
16~100V	0.90	1.00	1.15	1.25

PART NUMBER SYSTEM (EXAMPLE : 16V 4700µF)

1	2 3	4 5 6	7	8 9	10	11 12	13 14
E	AP	478	M	1C	N	25	SW

Type (Terminal Code)
 Case Length (25mm)
 Diameter (22mm)
 Voltage (16V)
 Tolerance (±20%)
 Capacitance (4700µF)
 Series
 E-CAP

STANDARD RATINGS

Voltage (Code)		16V (1C)		25V (1E)		35V (1V)		63V (1J)			
Cap. (µF)	Code	Case Size	Ripple Current	Case Size	Ripple Current	Case Size	Ripple Current	Case Size	Ripple Current		
680	687							22 x 25	0.75		
1000	108							22 x 30	1.00		
								25 x 25	1.00		
1500	158					22 x 25	1.15	22 x 35	1.30		
								25 x 30	1.30		
2200	228			22 x 25	1.35	22 x 30	1.50	22 x 45	1.75		
								25 x 40	1.80		
								30 x 30	1.75		
3300	338	22 x 20	1.35	22 x 30	1.80	22 x 35	1.95	25 x 50	2.45		
				25 x 25	1.80	25 x 30	1.95	30 x 40	2.45		
						30 x 25	2.00	35 x 30	2.40		
4700	478	22 x 25	1.80	22 x 35	2.30	22 x 45	2.55	30 x 50	3.20		
				25 x 30	2.30	25 x 40	2.65				
				30 x 25	2.40	30 x 30	2.60				
6800	688	22 x 35	2.25	22 x 45	2.75	25 x 50	3.10	35 x 50	3.75		
				25 x 40	2.80						
				30 x 30	2.75						
				30 x 25	2.35					35 x 30	3.00
10000	109	22 x 45	2.50	25 x 50	3.10	30 x 50	3.40				
				25 x 35	2.50						
				30 x 30	2.50					35 x 40	3.40
				35 x 25	2.60					35 x 30	3.00

Maximum Allowable Ripple Current (Arms) at 85°C 120Hz

Case Size Φ D x L (mm)

Voltage (Code)		80V (1K)		100V (2A)	
Cap. (µF)	Code	Case Size	Ripple Current	Case Size	Ripple Current
680	687	22 x 30	0.90	22 x 35	0.95
		25 x 25	0.90	25 x 30	1.00
				30 x 25	1.00
1000	108	22 x 35	1.20	22 x 50	1.35
		25 x 30	1.20	25 x 40	1.35
				30 x 30	1.35
1500	158	30 x 25	1.25	35 x 25	1.35
		22 x 50	1.70	25 x 50	1.80
		25 x 40	1.65	30 x 40	1.85
		30 x 30	1.65		
2200	228	35 x 25	1.65	35 x 25	1.35
		25 x 50	2.20	30 x 50	2.45
		30 x 40	2.20	35 x 40	2.45
35 x 30	2.15				
3300	338	30 x 50	3.00	35 x 40	2.45
		35 x 40	2.95		
4700	478	35 x 50	3.90		

Maximum Allowable Ripple Current (Arms) at 85°C 120Hz

Case Size Φ D x L (mm)

Specifications are subject to change without notice. Should a safety or technical concern arise regarding the product, please be sure to contact our sales offices or agents immediately.

FEATURES

- Designed for withstanding vibration.
- Suitable for washing machines and etc.



SPECIFICATIONS

Item	Performance Characteristics					
Operating Temperature Range	-40 to +85°C	-25 to +85°C				
Rated Working Voltage Range	10 to 250V	315 to 500V				
Nominal Capacitance Range	56 to 82000µF					
Capacitance Tolerance	±20% at 120Hz, +20°C					
Leakage Current	$I \leq 3\sqrt{CV}$ (µA) after 5 minutes application of rated working voltage at +20°C					
tan δ (120Hz, +20°C)	Working Voltage (V)	10 16 25 35 50 63 80				
	tan δ (max.)	0.55 0.50 0.45 0.40 0.35 0.30 0.25				
	Working Voltage (V)	100 160~250 315~450 500				
	tan δ (max.)	0.20 0.15 0.15 0.20				
	For capacitance value >33000µF, add following calculated value: $\frac{(\text{rated capacitance}) - 33000\mu\text{F}}{10000\mu\text{F}} \times 0.1$					
Low Temperature Characteristics	Impedance ratio max. at 120Hz					
	Working Voltage (V)	10~100	160~250	315~385	400~450	500
	Z-25°C / Z+20°C	4	3	5	8	8
	Z-40°C / Z+20°C	15	15	-	-	-
High Temperature Loading	Test time	: 2,000 hours		Post test requirements at +20°C		
	Test temperature	: +85°C		Leakage current : ≤Initial specified value		
	Test condition	: Rated DC working voltage with rated ripple current		Cap. change : within ±20% of the initial measured value		
				tan δ : ≤200% of the initial specified value		
Shelf Life	At +85°C no voltage applied after 1,000 hours and then being stabilized at +20°C the capacitors shall meet the following limits					
	Leakage current	: ≤Initial specified value				
	Cap. change	: within ±15% of the initial measured value				
	tan δ	: ≤150% of the initial specified value				
Industrial Standard	JIS C - 5101-4 (IEC 60384-4)					

RIPPLE CURRENT MULTIPLIER

Frequency Coefficient

Coefficient Rated Voltage	Freq. (Hz)			
	60	120	1k	10k-50k
10~100V	0.90	1.00	1.15	1.25
160~250V	0.80	1.00	1.15	1.47
315~500V	0.80	1.00	1.15	1.47

PART NUMBER SYSTEM (EXAMPLE : 160V 1000µF)

1	2 3	4 5 6	7	8 9	10	11 12	13 14
E	QP	108	M	2C	O	40	SW

Type (Terminal Code)
 Case Length (40mm)
 Diameter (25mm)
 Voltage (160V)
 Tolerance (±20%)
 Capacitance (1000µF)
 Series
 E-CAP

STANDARD RATINGS

Voltage (Code)		10V (1A)		16V (1C)		25V (1E)		35V (1V)	
Cap. (µF)	Code	Case Size	Ripple Current	Case Size	Ripple Current	Case Size	Ripple Current	Case Size	Ripple Current
2700	278							20 x 25	1.76
3300	338							20 x 30	2.14
3900	398							20 x 30	2.28
								22 x 25	2.22
4700	478					20 x 25	2.18	20 x 35	2.46
								22 x 30	2.46
								25 x 25	2.43
5600	568					20 x 30	2.33	22 x 35	2.79
						22 x 25	2.31	25 x 30	2.75
6800	688			20 x 25	2.33	20 x 35	2.56	22 x 40	2.89
								25 x 30	2.89
						22 x 30	2.56	30 x 25	3.09
8200	828	22 x 40	22 x 40	20 x 30	2.56	20 x 40	2.91	22 x 45	3.47
		25 x 30	25 x 30	22 x 25	2.56	22 x 35	2.81	25 x 35	3.33
		30 x 25	30 x 25	22 x 25	2.56	25 x 25	2.78	30 x 30	3.29
10000	109	20 x 25	2.22	20 x 35	2.85	22 x 35	3.18	22 x 50	3.59
				22 x 30	2.81	25 x 30	3.16	25 x 40	3.59
12000	129	20 x 30	2.44	20 x 40	3.20	22 x 40	3.53	30 x 30	3.61
				22 x 30	3.13	25 x 35	3.48	25 x 45	4.01
		22 x 25	2.41	25 x 25	2.96	30 x 25	3.53	30 x 35	4.01
15000	159	20 x 35	2.90	22 x 35	3.69	22 x 50	4.08	35 x 30	4.02
		22 x 30	2.88	25 x 30	3.64	25 x 40	4.00	30 x 40	4.80
		25 x 25	2.88	30 x 25	3.73	30 x 30	4.00	35 x 35	4.08
18000	189	20 x 40	3.31	22 x 40	3.98	25 x 45	4.68	30 x 45	5.18
		22 x 35	3.22	25 x 35	3.98	30 x 35	4.66	35 x 40	5.71
		25 x 30	3.08	30 x 30	3.88	35 x 30	4.68		
22000	229	22 x 40	3.79	22 x 50	4.52	30 x 40	5.19		
		25 x 30	3.66	25 x 40	4.44			35 x 45	6.38
		30 x 25	3.53	30 x 30	4.38	35 x 35	5.20		
27000	279	22 x 45	4.04	25 x 45	4.98	30 x 45	6.02		
		25 x 35	4.04	30 x 35	4.82			35 x 50	6.90
		30 x 30	3.99	35 x 30	4.82	35 x 40	6.02		
33000	339	22 x 50	4.58	25 x 50	5.49				
		25 x 40	4.56	30 x 40	5.38	35 x 45	6.75		
		30 x 30	4.58	35 x 35	5.33				
39000	399	25 x 45	5.29	30 x 45	6.11				
		30 x 35	5.21			35 x 50	7.56		
		35 x 30	5.50	35 x 35	6.01				
47000	479	25 x 50	5.78	30 x 50	6.80				
		30 x 40	5.78						
		35 x 35	5.55	35 x 40	6.80				
56000	569	30 x 45	6.59	35 x 45	7.62				
		35 x 35	6.40						
68000	689	30 x 50	7.50						
		35 x 40	7.48						
82000	829	35 x 50	8.50						

Maximum Allowable Ripple Current (Arms) at 85°C 120Hz

Case Size ΦD x L (mm)

Specifications are subject to change without notice. Should a safety or technical concern arise regarding the product, please be sure to contact our sales offices or agents immediately.



STANDARD RATINGS

Voltage (Code)		50V (1H)		63V (1J)		80V (1K)		100V (2A)	
Cap. (µF)	Code	Case Size	Ripple Current	Case Size	Ripple Current	Case Size	Ripple Current	Case Size	Ripple Current
680	687							20 x 25	1.66
820	827							20 x 30	1.85
								22 x 25	1.86
1000	108					20 x 25	1.56	20 x 35	2.02
								22 x 30	2.02
1200	128					20 x 30	1.80	20 x 40	2.12
								22 x 30	2.12
1500	158					22 x 25	1.77	25 x 25	2.10
						20 x 35	2.10	22 x 35	2.45
1800	188			20 x 25	1.69	22 x 30	2.01	25 x 30	2.43
				20 x 30	2.04	20 x 40	2.30	22 x 40	2.77
2200	228	20 x 25	1.70	22 x 25	1.90	22 x 35	2.25	25 x 35	2.77
						25 x 25	2.26	30 x 25	2.65
2700	278	20 x 30	2.07	20 x 35	2.40	22 x 40	2.53	22 x 45	3.12
						22 x 30	2.35	25 x 30	2.53
3300	338	22 x 25	1.93	25 x 25	2.30	30 x 25	2.50	30 x 30	3.10
						20 x 40	2.52	22 x 45	2.93
3900	398	20 x 35	2.21	22 x 35	2.50	25 x 35	2.93	25 x 45	3.61
						22 x 30	2.21	30 x 35	3.60
4700	478			25 x 30	2.49	30 x 30	2.91	35 x 30	3.71
		20 x 40	2.41	22 x 40	2.69	22 x 50	3.25	25 x 50	4.06
5600	568	22 x 30	2.41	25 x 30	2.69	25 x 40	3.25	30 x 40	4.05
						25 x 25	2.38	30 x 30	3.23
6800	688	30 x 25	2.38	30 x 25	2.78	30 x 30	3.23	35 x 35	4.07
						22 x 35	2.72	22 x 45	3.10
8200	828	25 x 30	2.68	25 x 35	3.09	25 x 45	3.62	30 x 45	4.60
						30 x 30	3.09	30 x 35	3.62
10000	109	22 x 40	3.01	22 x 50	3.49	25 x 50	4.28	30 x 50	5.13
		25 x 30	3.03	25 x 40	3.37	30 x 40	4.15	35 x 40	5.12
12000	129	30 x 25	3.01	30 x 30	3.37	35 x 30	4.10		
						22 x 45	3.43	25 x 45	3.80
15000	159	25 x 35	3.37	30 x 35	3.81	30 x 45	4.55	35 x 45	5.75
						30 x 30	3.43	35 x 35	4.51
18000	189	30 x 30	3.43	35 x 30	3.75	35 x 35	4.51		
						22 x 50	3.94	25 x 50	4.41
20000	209	25 x 40	3.87	30 x 40	4.41	30 x 50	5.18	35 x 50	6.01
		30 x 35	3.87	35 x 35	4.33	35 x 40	5.14		
25000	259	25 x 45	4.37	30 x 45	4.90				
		30 x 35	4.42	35 x 35	4.80	35 x 45	5.83		
30000	309	35 x 30	4.41	35 x 35	4.80				
						30 x 40	5.02	30 x 50	5.49
35000	359	30 x 40	5.02	30 x 50	5.49				
						35 x 35	4.92	35 x 40	5.47
40000	409	35 x 35	4.92	35 x 40	5.47				
						30 x 50	5.60	35 x 50	6.30
45000	459	30 x 50	5.60	35 x 50	6.30				
						35 x 40	5.60		
50000	509	35 x 40	5.60						
						35 x 45	6.44		
55000	559	35 x 45	6.44						
						35 x 50	6.71		

Maximum Allowable Ripple Current (Arms) at 85°C 120Hz

Case Size ΦD x L (mm)

Specifications are subject to change without notice. Should a safety or technical concern arise regarding the product, please be sure to contact our sales offices or agents immediately.

QP Large Can Aluminum Electrolytic Capacitors

STANDARD RATINGS

Voltage (Code)		160V (2C)		180V (2P)		200V (2D)		220V (2N)	
Cap. (µF)	Code	Case Size	Ripple Current	Case Size	Ripple Current	Case Size	Ripple Current	Case Size	Ripple Current
180	187							20 x 25	1.09
220	227					20 x 25	1.13	20 x 30 22 x 25	1.15 1.09
270	277	20 x 25	1.22	20 x 25	1.23	20 x 30 22 x 25	1.32 1.30	20 x 30 22 x 25	1.38 1.31
330	337	20 x 30	1.48	20 x 30 22 x 25	1.48 1.42	20 x 30 22 x 25	1.49 1.44	20 x 35 22 x 30 25 x 25	1.51 1.58 1.49
390	397	20 x 30 22 x 25	1.55 1.55	20 x 30 22 x 30	1.58 1.61	20 x 35 22 x 30 25 x 25	1.66 1.65 1.63	20 x 40 22 x 35 25 x 30	1.73 1.69 1.71
470	477	20 x 35 22 x 30 25 x 25	1.81 1.77 1.77	20 x 35 22 x 30 25 x 25	1.82 1.80 1.80	20 x 40 22 x 35 25 x 30	1.93 1.88 1.86	22 x 40 25 x 30 30 x 25	1.99 1.95 1.89
560	567	20 x 40 22 x 35 25 x 30	2.04 2.05 2.05	20 x 40 22 x 35 25 x 30	2.04 2.09 2.05	22 x 40 25 x 30 30 x 25	2.08 2.05 2.05	22 x 45 25 x 35 30 x 30	2.28 2.22 2.19
680	687	22 x 40 25 x 30 30 x 25	2.24 2.22 2.22	22 x 40 25 x 35 30 x 25	2.36 2.34 2.27	22 x 45 25 x 35 30 x 30	2.36 2.36 2.36	22 x 50 25 x 40 30 x 30	2.46 2.40 2.39
820	827	22 x 45 25 x 35 30 x 30	2.55 2.52 2.51	22 x 45 25 x 35 30 x 30	2.72 2.58 2.56	22 x 50 25 x 40 30 x 30	2.68 2.66 2.62	25 x 45 30 x 35 35 x 30	2.81 2.70 2.62
1000	108	22 x 50 25 x 40 30 x 30	2.88 2.86 2.82	25 x 45 30 x 35	2.91 2.95	25 x 45 30 x 35 35 x 30	3.12 3.00 2.96	25 x 50 30 x 40 35 x 35	3.13 3.08 3.05
1200	128	25 x 45 30 x 35 35 x 30	3.27 3.25 3.24	25 x 50 30 x 40 35 x 30	3.46 3.38 3.32	25 x 50 30 x 40 35 x 35	3.44 3.44 3.40	30 x 45 35 x 40	3.60 3.51
1500	158	30 x 40 35 x 35	3.77 3.75	30 x 45 35 x 35	3.90 3.83	30 x 50 35 x 40	3.93 3.87	35 x 45	3.92
1800	188	30 x 45 35 x 35	4.10 4.08	30 x 50 35 x 40	4.33 4.32	35 x 45	4.37		
2200	228	35 x 45	4.72	35 x 45	4.60	35 x 50	5.00		
2700	278	35 x 50	5.30	35 x 50	5.05				

Maximum Allowable Ripple Current (Arms) at 85°C 120Hz

Case Size Φ D x L (mm)



STANDARD RATINGS

Voltage (Code)		250V (2E)		315V (2F)		350V (2V)		385V (2Y)	
Cap. (μF)	Code	Case Size	Ripple Current	Case Size	Ripple Current	Case Size	Ripple Current	Case Size	Ripple Current
68	686							20 x 25	0.60
82	826							20 x 30	0.67
								22 x 25	0.70
100	107							20 x 30	0.80
								22 x 30	0.82
120	127					20 x 30	0.91	20 x 35	0.89
						22 x 25	0.99	25 x 25	0.95
150	157					20 x 35	1.05	20 x 40	1.05
				20 x 30	0.95	22 x 30	1.14	22 x 35	1.04
						25 x 25	1.16	25 x 30	1.08
180	187	20 x 25	1.14	20 x 35	1.08	20 x 40	1.18	20 x 40	1.18
				22 x 30	1.23	22 x 35	1.28	25 x 35	1.20
				25 x 25	1.31	25 x 30	1.30	30 x 25	1.28
220	227	20 x 30	1.20	20 x 40	1.23	22 x 40	1.40	22 x 45	1.33
				22 x 35	1.34	25 x 35	1.46	25 x 35	1.44
		22 x 25	1.18	25 x 30	1.40	30 x 25	1.47	30 x 30	1.40
270	277	20 x 30	1.35	22 x 40	1.60	22 x 45	1.62	25 x 40	1.56
				25 x 35	1.65	30 x 35	1.62		
		22 x 30	1.43	25 x 30	1.62	30 x 30	1.71		
330	337	20 x 35	1.60	22 x 45	1.82	22 x 50	1.78	25 x 50	1.80
		22 x 30	1.58	25 x 35	1.85	25 x 40	1.88	30 x 40	1.85
		25 x 25	1.53	30 x 30	1.89	30 x 35	1.93	35 x 30	1.85
390	397	20 x 40	1.83	22 x 50	1.97	25 x 45	2.04	30 x 40	2.04
		22 x 35	1.79	25 x 40	2.01	30 x 35	2.12	35 x 35	2.06
		25 x 30	1.79	30 x 30	2.05	35 x 30	2.19		
470	477	22 x 40	2.05	25 x 45	2.20	30 x 40	2.41	30 x 50	2.27
		25 x 35	2.05	30 x 35	2.27	35 x 35	2.43	35 x 40	2.30
		30 x 25	1.94	35 x 30	2.25				
560	567	22 x 45	2.36	30 x 40	2.50	30 x 45	2.60	35 x 45	2.57
		25 x 35	2.24	35 x 35	2.56	35 x 35	2.62		
		30 x 30	2.24						
680	687	25 x 40	2.54	30 x 45	2.67	35 x 40	3.00	35 x 50	2.80
		30 x 35	2.58	35 x 40	2.90				
820	827	25 x 50	2.87	30 x 50	3.12	35 x 50	3.30		
		30 x 35	2.84	35 x 45	3.29				
		35 x 30	2.82						
1000	108	30 x 45	3.39	35 x 50	3.40				
		35 x 35	3.31						
1200	128	30 x 50	3.80						
		35 x 40	3.66						
1500	158	35 x 45	4.12						
1800	188	35 x 50	4.31						

Maximum Allowable Ripple Current (Arms) at 85°C 120Hz

Case Size ΦD x L (mm)

Specifications are subject to change without notice. Should a safety or technical concern arise regarding the product, please be sure to contact our sales offices or agents immediately.

QP Large Can Aluminum Electrolytic Capacitors

STANDARD RATINGS

Voltage (Code)		400V (2G)		420V (2M)		450V (2W)		500V (2H)	
Cap. (µF)	Code	Case Size	Ripple Current	Case Size	Ripple Current	Case Size	Ripple Current	Case Size	Ripple Current
56	566					20 x 25	0.58		
68	686	20 x 25	0.71	20 x 25	0.65	20 x 30	0.67		
						22 x 25	0.68		
82	826	20 x 30	0.78	20 x 30	0.73	20 x 35	0.76		
		22 x 25	0.80	22 x 25	0.75	22 x 30	0.82		
100	107	20 x 30	0.90	20 x 35	0.85	20 x 35	0.84		
				22 x 30	0.87	22 x 35	0.90	30 x 25	0.90
		22 x 30	0.94	25 x 25	0.92	25 x 25	0.92		
120	127	20 x 35	1.02	20 x 35	0.99	20 x 40	0.94	30 x 30	1.00
		22 x 30	1.04	22 x 30	1.01	22 x 35	1.02		
		25 x 25	1.08	25 x 25	1.03	25 x 30	1.04	35 x 25	1.00
						30 x 25	1.07		
150	157	20 x 40	1.16	20 x 45	1.15	22 x 40	1.12		
				22 x 35	1.19				
		22 x 35	1.18	25 x 30	1.19	25 x 35	1.19	30 x 35	1.20
		25 x 30	1.21	30 x 25	1.14	30 x 30	1.23		
180	187	22 x 40	1.34	22 x 45	1.36	22 x 50	1.26	30 x 40	1.40
		25 x 35	1.37	25 x 35	1.37	25 x 40	1.33		
		30 x 25	1.45	30 x 25	1.35	30 x 30	1.38	35 x 30	1.30
220	227	22 x 45	1.50	22 x 50	1.69	25 x 45	1.51	30 x 45	1.60
		25 x 35	1.56	25 x 40	1.58	30 x 35	1.56		
		30 x 30	1.58	30 x 30	1.56	35 x 30	1.58	35 x 35	1.50
270	277	25 x 40	1.70	25 x 45	1.83	25 x 50	1.65	30 x 50	1.80
				30 x 35	1.72	30 x 40	1.80		
		30 x 35	1.73	35 x 30	1.76	35 x 35	1.81	35 x 40	1.70
330	337	25 x 50	1.90	25 x 50	2.18	30 x 45	2.02		
		30 x 40	1.95	30 x 40	1.98			35 x 45	2.00
		35 x 30	1.95	35 x 35	2.04	35 x 35	2.05		
390	397	30 x 40	2.15	30 x 45	2.34	30 x 50	2.24	35 x 50	2.30
		35 x 35	2.17	35 x 35	2.26	35 x 40	2.27		
470	477	30 x 50	2.39	30 x 50	2.67	35 x 45	2.55		
		35 x 40	2.42	35 x 40	2.60				
560	567	35 x 45	2.71	35 x 45	2.93				
680	687	35 x 50	2.95						

Maximum Allowable Ripple Current (Arms) at 85°C 120Hz

Case Size Φ D x L (mm)

FEATURES

- High ripple current and high reliability.
- Low equivalent series resistance ESR.
- Different case sizes available for each capacitance value.
- Load life with ripple current: 5,000 hours.



SPECIFICATIONS

Item	Performance Characteristics					
Operating Temperature Range	-40 to +85°C			-25 to +85°C		
Rated Working Voltage Range	160 to 250V			385 to 450V		
Nominal Capacitance Range	47 to 2200µF					
Capacitance Tolerance	±20% at 120Hz, +20°C					
Leakage Current	I ≤ 3√CV (µA) after 5 minutes application of rated working voltage at +20°C					
tan δ (120Hz, +20°C)	Working Voltage (V)	160~420	450			
	tan δ (max.)	0.15	0.20			
Low Temperature Characteristics	Impedance ratio max. at 120Hz					
	Working Voltage (V)	160	200	250	385	400~450
	Z-25°C / Z+20°C	3	3	3	5	8
	Z-40°C / Z+20°C	15	-	-	-	-
High Temperature Loading	Test time	: 5,000 hours			Post test requirements at +20°C	
	Test temperature	: +85°C			Leakage current : ≤Initial specified value	
	Test conditions	: Rated DC working voltage with rated ripple current			Cap. change : within ±20% of the initial measured value	
					tan δ : ≤200% of the initial specified value	
Shelf Life	At +85°C no voltage applied after 1,000 hours and then being stabilized at +20°C the capacitors shall meet the following limits					
	Leakage current	: ≤Initial specified value				
	Cap. change	: within ±15% of the initial measured value				
	tan δ	: ≤150% of the initial specified value				
Industrial Standard	JIS C - 5101-4 (IEC 60384-4)					

RIPPLE CURRENT MULTIPLIER

Frequency Coefficient

Coefficient	Freq. (Hz)	60	120	1k	10k~50k
	160~250V	0.80	1.00	1.15	1.47
	385~450V	0.80	1.00	1.15	1.47

PART NUMBER SYSTEM (EXAMPLE : 400V 330µF)

1	2 3	4 5 6	7	8 9	10	11 12	13 14
E	DP	337	M	2G	P	45	SW



STANDARD RATINGS

Voltage (Code)		160V (2C)			200V (2D)			250V (2E)		
Cap. (µF)	Code	Case Size	Impedance	Ripple Current	Case Size	Impedance	Ripple Current	Case Size	Impedance	Ripple Current
150	157							22 x 25	800	0.91
220	227	22 x 25	730	1.10	22 x 25	490	1.10	22 x 30	500	1.20
								25 x 25	490	1.20
330	337	22 x 30	490	1.40	22 x 30	330	1.40	22 x 40	330	1.60
					25 x 25	330	1.50	25 x 30	330	1.60
470	477	22 x 35	350	1.80	22 x 40	240	1.90	25 x 40	240	2.10
					30 x 25	350	1.90	30 x 30	240	2.00
680	687	25 x 35	240	2.40	25 x 40	160	2.50	30 x 40	160	2.70
					30 x 30	160	2.40			
1000	108	30 x 35	160	3.10	30 x 40	120	3.30	35 x 40	120	3.60
					35 x 35	120	3.50			
1500	158	30 x 45	120	4.20	35 x 45	80	4.60			
2200	228	35 x 50	80	5.80						

Maximum Allowable Ripple Current (Arms) at 85°C 120Hz

Case Size Φ D x L (mm)

Maximum Impedance (mΩ) at 20°C 20kHz

Voltage (Code)		385V (2Y)			400V (2G)			420V (2M)		
Cap. (µF)	Code	Case Size	Impedance	Ripple Current	Case Size	Impedance	Ripple Current	Case Size	Impedance	Ripple Current
68	686	22 x 25	1570	0.61	22 x 25	1570	0.61			
100	107	22 x 30	1070	0.79	22 x 30	1070	0.79	22 x 30	1600	0.79
		25 x 25	1070	0.80	25 x 25	1070	0.80	25 x 25	1600	0.80
120	127				22 x 35	890	0.92	22 x 30	1330	0.94
150	157	22 x 40	720	1.10	22 x 40	720	1.10	22 x 40	1070	1.08
		25 x 30	720	1.00	30 x 25	720	1.10	25 x 35	1070	1.11
180	187				30 x 30	600	1.20	25 x 35	890	1.21
								30 x 30	890	1.26
220	227	25 x 40	490	1.40	25 x 40	490	1.40	25 x 40	730	1.41
		30 x 30	490	1.40	30 x 35	490	1.50	30 x 35	730	1.46
270	277				30 x 35	400	1.60	30 x 35	590	1.62
								35 x 30	590	1.71
330	337	30 x 40	330	1.90	30 x 45	330	2.00	30 x 45	490	1.96
								35 x 35	490	1.98
390	397				30 x 50	280	2.20	30 x 50	410	2.22
470	477	35 x 40	240	2.50	35 x 45	240	2.60	35 x 45	340	2.58
560	567	35 x 45	200	2.80	35 x 50	200	2.90	35 x 50	290	2.93

Maximum Allowable Ripple Current (Arms) at 85°C 120Hz

Case Size Φ D x L (mm)

Maximum Impedance (mΩ) at 20°C 20kHz

Voltage (Code)		450V (2W)		
Cap. (µF)	Code	Case Size	Impedance	Ripple Current
47	476	22 x 25	3400	0.51
68	686	22 x 30	2350	0.65
		25 x 25	2350	0.66
100	107	22 x 40	1600	0.88
		25 x 30	1600	0.86
		30 x 25	1600	0.90
150	157	25 x 40	1070	1.20
		30 x 30	1070	1.10
180	187	30 x 35	890	1.30
220	227	30 x 40	730	1.50
270	277	30 x 45	600	1.80
330	337	35 x 40	490	2.10
470	477	35 x 50	350	2.70

Maximum Allowable Ripple Current (Arms) at 85°C 120Hz

Case Size Φ D x L (mm)

Maximum Impedance (mΩ) at 20°C 20kHz

Specifications are subject to change without notice. Should a safety or technical concern arise regarding the product, please be sure to contact our sales offices or agents immediately.

FEATURES

- Directly mountable on printed circuit board without holders.
- Terminal spacing fixed at 10mm for PC board plug in.
- Aluminum case designed with explosion-proof vent.
- Load life: 10,000 hours.



SPECIFICATIONS

Item	Performance Characteristics		
Operating Temperature Range	-25 to +85°C		
Rated Working Voltage Range	200 to 450V		
Nominal Capacitance Range	56 to 2200µF		
Capacitance Tolerance	±20% at 120Hz, +20°C		
Leakage Current	$I \leq 3\sqrt{CV}$ (µA) after 5 minutes application of rated working voltage at +20°C		
tan δ (120Hz, +20°C)	Working Voltage (V)	200~250	400~450
	tan δ (max.)	0.15	0.15
Low Temperature Characteristics	Impedance ratio max. at 120Hz		
	Working Voltage (V)	200~250	400~450
	Z-25°C / Z+20°C	3	8
High Temperature Loading	Test time	: 10,000 hours	Post test requirements at +20°C
	Test temperature	: +85°C	Leakage current : ≤Initial specified value
	Test conditions	: Rated DC working voltage with rated ripple current	Cap. change : within ±30% of the initial measured value
			tan δ : ≤300% of the initial specified value
Shelf Life	At +85°C no voltage applied after 1,000 hours and then being stabilized at +20°C the capacitors shall meet the following limits		
	Leakage current	: ≤Initial specified value	
	Cap. change	: within ±15% of the initial measured value	
	tan δ	: ≤150% of the initial specified value	
Industrial Standard	JIS C - 5101-4 (IEC 60384-4)		

RIPPLE CURRENT MULTIPLIER

Frequency Coefficient

Coefficient	Freq. (Hz)	Rated Voltage			
		60	120	1k	10k~50k
Rated Voltage	200~250V	0.80	1.00	1.15	1.47
	400~450V	0.80	1.00	1.15	1.47

PART NUMBER SYSTEM (EXAMPLE : 200V 470µF)

1	2 3	4 5 6	7	8 9	10	11 12	13 14
E	TP	477	M	2D	O	30	SW

Type (Terminal Code)
 Case Length (30mm)
 Diameter (25mm)
 Voltage (200V)
 Tolerance (±20%)
 Capacitance (470µF)
 Series
 E-CAP

STANDARD RATINGS

Voltage (Code)		200V (2D)		250V (2E)		400V (2G)		450V (2W)	
Cap. (µF)	Code	Case Size	Ripple Current	Case Size	Ripple Current	Case Size	Ripple Current	Case Size	Ripple Current
56	566							20 x 25	0.58
68	686					20 x 25	0.71	20 x 30	0.67
								22 x 25	0.68
82	826					20 x 30	0.78	20 x 35	0.76
						22 x 25	0.80	22 x 30	0.82
100	107					20 x 30	0.90	20 x 35	0.84
						22 x 30	0.94	22 x 35	0.90
120	127					20 x 35	1.02	20 x 40	0.94
						22 x 30	1.04	22 x 35	1.02
						25 x 25	1.08	25 x 30	1.04
150	157					20 x 40	1.16	22 x 40	1.12
						22 x 35	1.18	25 x 35	1.19
180	187			20 x 25	1.14	25 x 30	1.21	30 x 30	1.23
						22 x 40	1.34	22 x 50	1.26
						25 x 35	1.37	25 x 40	1.33
220	227	20 x 25	1.13	20 x 30	1.20	30 x 25	1.45	30 x 30	1.38
				22 x 25	1.18	22 x 45	1.50	25 x 45	1.51
						25 x 35	1.56	30 x 35	1.56
270	277	20 x 30	1.32	20 x 30	1.35	30 x 30	1.58	35 x 30	1.58
		22 x 25	1.30	22 x 30	1.43	25 x 40	1.70	25 x 50	1.65
330	337			20 x 35	1.60	30 x 35	1.73	35 x 35	1.81
				22 x 30	1.58	25 x 50	1.90	30 x 45	2.02
				25 x 25	1.53	30 x 40	1.95	30 x 45	2.02
390	397	20 x 35	1.66	20 x 40	1.83	35 x 30	1.95	35 x 35	2.05
		22 x 30	1.65	22 x 35	1.79	30 x 40	2.15	30 x 50	2.24
		25 x 25	1.63	25 x 30	1.79	35 x 35	2.17	35 x 40	2.27
470	477	20 x 40	1.93	22 x 40	2.05	30 x 50	2.39		
		22 x 35	1.88	25 x 35	2.05	35 x 40	2.42	35 x 45	2.55
		25 x 30	1.86	30 x 25	1.94				
560	567	22 x 40	2.08	22 x 45	2.36				
		25 x 30	2.05	25 x 35	2.24	35 x 45	2.71		
		30 x 25	2.05	30 x 30	2.24				
680	687	22 x 45	2.36	25 x 40	2.54				
		25 x 35	2.36	30 x 35	2.58	35 x 50	2.95		
820	827	30 x 30	2.36						
		22 x 50	2.68	25 x 50	2.87				
		25 x 40	2.66	30 x 35	2.84				
1000	108	30 x 30	2.62	35 x 30	2.82				
		25 x 45	3.12	30 x 45	3.39				
		30 x 35	3.00						
1200	128	35 x 30	2.96	35 x 35	3.31				
		25 x 50	3.44	30 x 50	3.80				
		30 x 40	3.44						
1500	158	35 x 35	3.40	35 x 40	3.66				
		30 x 50	3.93						
1800	188	35 x 40	3.87	35 x 45	4.12				
		35 x 45	4.37	35 x 50	4.31				
2200	228	35 x 50	5.00						

Maximum Allowable Ripple Current (Arms) at 85°C 120Hz

Case Size $\Phi D \times L$ (mm)

Specifications are subject to change without notice. Should a safety or technical concern arise regarding the product, please be sure to contact our sales offices or agents immediately.



FEATURES

- Highly reliable capacitors that withstand under high ripple current.
- Two or three dimensions with same ratings.
- Aluminum case designed explosion-proof vent.
- Best for switching power supplies.

SPECIFICATIONS

Item	Performance Characteristics									
Operating Temperature Range	-40 to +105°C				-25 to +105°C					
Rated Working Voltage Range	10 to 100V				160 to 500V					
Nominal Capacitance Range	47 to 56000µF									
Capacitance Tolerance	±20% at 120Hz, +20°C									
Leakage Current	I ≤ 3√CV (µA) after 5 minutes application of rated working voltage at +20°C									
tan δ (120Hz, +20°C)	Working Voltage (V)	10	16	25	35	50	63	80	100	
	tan δ (max.)	0.55	0.50	0.45	0.35	0.30	0.30	0.25	0.20	
	Working Voltage (V)	160~220		250	315~385		400~500			
	tan δ (max.)	0.15		0.15	0.15		0.20			
For capacitance value >33000µF, add following calculated value: $\frac{(\text{rated capacitance}) - 33000\mu\text{F}}{10000\mu\text{F}} \times 0.1$										
Low Temperature Characteristics	Impedance ratio max. at 120Hz									
	Working Voltage (V)	10	16	25	35	50	63	80	100	
	Z-25°C / Z+20°C	6	6	6	6	4	3	3	3	
	Z-40°C / Z+20°C	15	15	15	15	15	15	15	15	
High Temperature Loading	Working Voltage (V)	160~180	200~220	250	315~385	400	450	500		
	Z-25°C / Z+20°C	8	8	8	8	8	8	8		
	Test time	: 2,000 hours				Post test requirements at +20°C				
	Test temperature	: +105°C				Leakage current : ≤Initial specified value				
Shelf Life	Test conditions	: Rated DC working voltage with rated ripple current				Cap. change : within ±20% of the initial measured value				
						tan δ : ≤200% of the initial specified value				
		At +105°C no voltage applied after 1,000 hours and then being stabilized at +20°C the capacitors shall meet the following limits								
	Leakage current : ≤Initial specified value				Cap. change : within ±15% of the initial measured value					
	tan δ : ≤150% of the initial specified value									
Industrial Standard	JIS C - 5101-4 (IEC 60384-4)									

RIPPLE CURRENT MULTIPLIER

Frequency Coefficient

Coefficient	Freq. (Hz)			
	60	120	1k	10k~50k
Rated Voltage				
10~100V	0.90	1.00	1.15	1.25
160~250V	0.80	1.00	1.25	1.47
315~500V	0.80	1.00	1.30	1.47

PART NUMBER SYSTEM (EXAMPLE : 350V 220µF)

1	2 3	4 5 6	7	8 9	10	11 12	13 14
E	HP	227	M	2V	O	35	SW

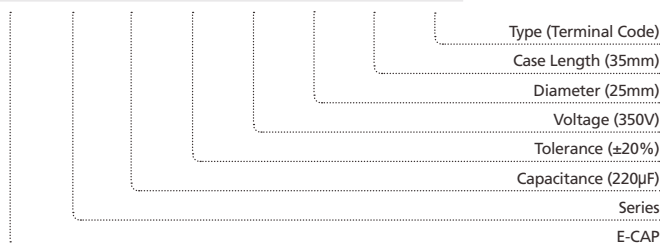

STANDARD RATINGS

Voltage (Code)		10V (1A)		16V (1C)		25V (1E)		35V (1V)	
Cap. (µF)	Code	Case Size	Ripple Current	Case Size	Ripple Current	Case Size	Ripple Current	Case Size	Ripple Current
2700	278							20 x 25	1.62
3300	338							20 x 30	1.94
								22 x 25	1.90
3900	398					20 x 25	1.72	20 x 35	2.02
								22 x 30	2.00
4700	478					20 x 30	2.04	20 x 40	2.21
						22 x 25	2.00	22 x 35	2.20
								25 x 25	2.20
5600	568			20 x 25	1.89	20 x 35	2.23	22 x 35	2.40
						22 x 30	2.20	25 x 30	2.40
6800	688	20 x 25	1.41	20 x 30	2.25	20 x 40	2.72	22 x 40	2.60
				22 x 25	2.20	22 x 30	2.40	25 x 35	2.78
						25 x 25	2.40	30 x 25	2.78
8200	828	20 x 30	1.67	20 x 35	2.43	22 x 35	2.70	22 x 50	2.90
				22 x 30	2.40	25 x 30	2.70	25 x 40	2.90
						30 x 25	2.70	30 x 30	2.90
10000	109	20 x 30	1.88	20 x 40	2.79	22 x 40	3.00	25 x 45	3.20
				22 x 30	2.60	25 x 35	3.00		
		22 x 25	1.80	25 x 25	2.60	30 x 30	3.00	30 x 35	3.20
12000	129	20 x 35	2.23	22 x 35	2.90	22 x 50	3.20	25 x 50	3.50
		22 x 30	2.20	25 x 30	2.90	25 x 40	3.20	30 x 40	3.50
		25 x 25	2.20	30 x 25	2.90	30 x 30	3.20	35 x 30	3.50
15000	159	20 x 40	2.31	22 x 40	3.20	25 x 45	3.60	30 x 45	3.90
		22 x 35	2.30	25 x 35	3.20	30 x 35	3.60	35 x 35	3.90
		25 x 25	2.30	30 x 30	3.20	35 x 30	3.60		
		22 x 40	2.52	22 x 45	3.50	30 x 40	3.90		
18000	189	25 x 30	2.40	25 x 40	3.50			35 x 40	4.51
		30 x 25	2.49	30 x 30	3.50	35 x 35	3.90		
22000	229	22 x 45	2.60	25 x 45	3.80	30 x 45	4.30		
		25 x 35	2.60	30 x 35	3.80			35 x 45	5.24
		30 x 25	2.60	35 x 30	3.80	35 x 35	4.30		
27000	279	22 x 50	3.19	25 x 50	4.20				
		25 x 40	3.10	30 x 40	4.20	35 x 45	4.80		
		30 x 30	3.10	35 x 30	4.20				
33000	339	25 x 45	3.40	30 x 45	4.70				
		30 x 35	3.40			35 x 50	5.55		
		35 x 30	3.40	35 x 35	4.70				
39000	399	30 x 40	3.79	30 x 50	5.10				
		35 x 30	3.70	35 x 40	5.10				
47000	479	30 x 45	4.26						
		35 x 35	4.20	35 x 45	5.50				
56000	569	35 x 40	5.00						

Maximum Allowable Ripple Current (Arms) at 105°C 120Hz

Case Size Φ D x L (mm)

STANDARD RATINGS

Voltage (Code)		50V (1H)		63V (1J)		80V (1K)		100V (2A)	
Cap. (µF)	Code	Case Size	Ripple Current	Case Size	Ripple Current	Case Size	Ripple Current	Case Size	Ripple Current
560	567							20 x 25	0.95
680	687							20 x 30	1.15
								22 x 25	1.09
820	827					20 x 25	1.04	20 x 35	1.31
								22 x 30	1.40
1000	108			20 x 25	1.21	20 x 30	1.24	20 x 35	1.43
						22 x 25	1.19	22 x 30	1.47
								25 x 25	1.45
1200	128			20 x 30	1.43	20 x 35	1.43	20 x 40	1.61
				22 x 25	1.40	22 x 30	1.50	22 x 35	1.69
								25 x 30	1.68
1500	158	20 x 25	1.29	20 x 35	1.52	20 x 35	1.57	22 x 40	1.97
				22 x 30	1.50	22 x 30	1.59	25 x 35	1.98
						25 x 25	1.59	30 x 25	1.95
1800	188	20 x 30	1.53	20 x 35	1.72	20 x 40	1.77	22 x 45	2.23
		22 x 25	1.50	22 x 30	1.70	22 x 35	1.79	25 x 40	2.20
				25 x 25	1.70	25 x 30	1.71	30 x 30	2.20
2200	228	20 x 35	1.72	20 x 40	2.01	22 x 40	2.03	25 x 45	2.53
				22 x 30	1.87	25 x 35	2.10	30 x 35	2.55
		22 x 30	1.70	25 x 30	2.00	30 x 25	1.98	35 x 30	2.60
2700	278	20 x 35	1.82	22 x 40	2.20	22 x 45	2.39	25 x 50	2.82
		22 x 30	1.80	25 x 35	2.20	25 x 40	2.35	30 x 40	2.86
		25 x 25	1.80	30 x 25	2.20	30 x 30	2.35	35 x 35	2.90
3300	338	20 x 40	2.01	22 x 45	2.60	25 x 45	2.64	30 x 45	3.30
		22 x 35	2.00	25 x 35	2.39	30 x 35	2.61	35 x 35	3.25
		25 x 30	2.00	30 x 30	2.50	35 x 30	2.60		
3900	398	22 x 40	2.23	25 x 40	2.57	25 x 25	2.92	30 x 50	3.60
		25 x 30	2.20			30 x 40	2.82		
		30 x 25	2.20	30 x 35	2.70	35 x 30	2.97	35 x 40	3.67
4700	478	22 x 45	2.50	25 x 50	3.00	30 x 45	3.34	35 x 45	3.80
		25 x 35	2.43	30 x 40	3.00				
		30 x 30	2.50	35 x 30	3.00	35 x 35	3.38		
5600	568	22 x 50	2.80	30 x 40	3.22	30 x 50	3.80	35 x 50	4.05
		25 x 40	2.80						
		30 x 30	2.76	35 x 35	3.30	35 x 40	3.80		
6800	688	25 x 45	3.30	30 x 50	3.86				
		30 x 35	3.30			35 x 45	3.90		
		35 x 30	3.30	35 x 40	3.84				
8200	828	30 x 40	3.71	35 x 45	4.43	35 x 50	4.20		
		35 x 35	3.85						
10000	109	30 x 45	4.30	35 x 50	5.11				
		35 x 40	4.49						
12000	129	35 x 45	4.56						
15000	159	35 x 50	4.80						

Maximum Allowable Ripple Current (Arms) at 105°C 120Hz

Case Size Φ D x L (mm)

Specifications are subject to change without notice. Should a safety or technical concern arise regarding the product, please be sure to contact our sales offices or agents immediately.

STANDARD RATINGS

Voltage (Code)		160V (2C)		180V (2P)		200V (2D)		220V (2N)	
Cap. (µF)	Code	Case Size	Ripple Current	Case Size	Ripple Current	Case Size	Ripple Current	Case Size	Ripple Current
180	187							20 x 25	0.90
220	227			20 x 25	1.00	20 x 25	1.00	20 x 30 22 x 25	1.00 1.00
270	277	20 x 25	1.10	20 x 30 22 x 25	1.10 1.00	20 x 30 22 x 25	1.10 1.10	20 x 35 22 x 30	1.15 1.15
330	337	20 x 30 22 x 25	1.20 1.20	20 x 30 22 x 25	1.20 1.20	20 x 35 22 x 30 25 x 25	1.20 1.25 1.25	20 x 40 22 x 35 25 x 25	1.25 1.25 1.25
390	397	20 x 35 22 x 30	1.42 1.30	20 x 35 22 x 30 25 x 25	1.30 1.35 1.35	20 x 40 22 x 30 25 x 25	1.31 1.35 1.35	20 x 45 22 x 35 25 x 30	1.40 1.40 1.40
470	477	20 x 40 22 x 30 25 x 25	1.34 1.55 1.55	20 x 40 22 x 35 25 x 30	1.40 1.50 1.50	22 x 35 25 x 30 30 x 25	1.50 1.50 1.50	25 x 40 25 x 30 30 x 25	1.51 1.44 1.50
560	567	22 x 35 25 x 30	1.67 1.67	22 x 40 25 x 30 30 x 25	1.67 1.67 1.67	22 x 40 25 x 30 30 x 25	1.67 1.59 1.67	22 x 45 25 x 35 30 x 30 35 x 25	1.70 1.64 1.70 1.71
680	687	22 x 40 25 x 35 30 x 25	1.82 1.85 1.82	22 x 45 25 x 35 30 x 30	1.78 1.78 1.78	22 x 45 25 x 35 30 x 30	1.78 1.72 1.78	25 x 40 30 x 35 35 x 30	1.84 1.93 1.89
820	827	22 x 45 25 x 35 30 x 30	2.04 2.04 2.04	22 x 50 25 x 40 30 x 30	2.04 2.04 2.04	25 x 40 30 x 35 35 x 25	1.99 2.04 2.04	25 x 45 30 x 40 35 x 30	2.08 2.19 2.16
1000	108	25 x 45 30 x 35	2.40 2.25	25 x 45 30 x 35 35 x 30	2.30 2.30 2.30	25 x 50 30 x 35 35 x 30	2.42 2.30 2.30	30 x 45 35 x 35	2.50 2.44
1200	128	25 x 50 30 x 35 35 x 30	2.62 2.49 2.49	30 x 40 35 x 35	2.55 2.55	30 x 40 35 x 35	2.65 2.65	35 x 40	2.79
1500	158	30 x 40 35 x 35	2.84 2.84	30 x 45 35 x 35	2.90 2.90	35 x 40	3.08	35 x 45	3.22
1800	188	30 x 50 35 x 35	3.32 3.00	35 x 40	3.30	35 x 45	3.48		
2200	228	35 x 45	3.50	35 x 50	3.65				

Maximum Allowable Ripple Current (Arms) at 105°C 120Hz

Case Size Φ D x L (mm)

STANDARD RATINGS

Voltage (Code)		250V (2E)		315V (2F)		350V (2V)		385V (2Y)	
Cap. (μF)	Code	Case Size	Ripple Current	Case Size	Ripple Current	Case Size	Ripple Current	Case Size	Ripple Current
56	566							20 x 25	0.37
68	686					20 x 25	0.47	20 x 30 22 x 25	0.44 0.45
82	826			20 x 25	0.64	20 x 30	0.54	20 x 30 22 x 30	0.50 0.52
100	107			20 x 30	0.69	20 x 30 22 x 25	0.60 0.69	20 x 35 20 x 30 25 x 25	0.56 0.58 0.57
120	127			20 x 30	0.75	20 x 35	0.68	20 x 40 22 x 30	0.66 0.64
				22 x 25	0.75	22 x 25	0.70	25 x 30 22 x 40	0.68 0.79
150	157	20 x 25	0.79	20 x 35 22 x 30 25 x 25	0.82 0.82 0.82	20 x 40 22 x 30	0.78 0.77	25 x 30 30 x 25	0.78 0.75
180	187	20 x 30 22 x 25	0.90 0.88	20 x 40 22 x 30 25 x 25	0.90 0.86 0.86	22 x 35 25 x 30 30 x 25	0.87 0.92 0.90	22 x 40 25 x 35 30 x 30	0.84 0.86 0.88
220	227	20 x 35	1.00	22 x 35 25 x 30	0.98 1.04	22 x 40 25 x 35	1.00 1.04	22 x 45 25 x 35	0.96 0.94
		22 x 25	1.00	30 x 25	1.04	30 x 30	1.02	30 x 30	1.00
270	277	20 x 40 22 x 30 25 x 30	1.10 1.18 1.27	22 x 40 25 x 35 30 x 25	1.10 1.16 1.16	22 x 45 25 x 40 30 x 30	1.11 1.18 1.17	25 x 45 30 x 35 35 x 30	1.13 1.08 1.10
330	337	22 x 35 25 x 30 30 x 25	1.30 1.30 1.35	22 x 45 25 x 40 30 x 30	1.27 1.33 1.33	25 x 45 30 x 35 35 x 30	1.29 1.34 1.22	30 x 45 35 x 30	1.31 1.24
390	397	22 x 40 25 x 35 30 x 25	1.49 1.49 1.49	25 x 40 30 x 35 35 x 30	1.40 1.47 1.47	25 x 50 30 x 35	1.51 1.43	30 x 45 35 x 35	1.41 1.40
470	477	22 x 45 25 x 40 30 x 30	1.65 1.65 1.65	30 x 40 35 x 30	1.70 1.70	30 x 40 35 x 35	1.57 1.69	35 x 40	1.68
560	567	25 x 45 30 x 35	1.80 1.80	30 x 40 35 x 35	1.95 2.05	30 x 50 35 x 40	1.85 1.90	35 x 45	1.87
680	687	25 x 50 30 x 35 35 x 30	2.03 2.00 2.00	35 x 40	2.17	35 x 45	2.20		
820	827	30 x 40 35 x 35	2.30 2.30	35 x 45	2.20				
1000	108	30 x 50 35 x 40	2.70 2.69						
1200	128	35 x 45	3.09						

Maximum Allowable Ripple Current (Arms) at 105°C 120Hz

Case Size ΦD x L (mm)

Specifications are subject to change without notice. Should a safety or technical concern arise regarding the product, please be sure to contact our sales offices or agents immediately.

STANDARD RATINGS

Voltage (Code)		400V (2G)		420V (2M)		450V (2W)		500V (2H)	
Cap. (µF)	Code	Case Size	Ripple Current	Case Size	Ripple Current	Case Size	Ripple Current	Case Size	Ripple Current
47	476					20 x 25	0.39	22 x 25	0.35
56	566	20 x 25	0.51	20 x 25	0.51	20 x 30	0.51	22 x 25	0.38
						22 x 25	0.50		
68	686	20 x 30	0.56	20 x 30	0.56	20 x 35	0.56	22 x 30	0.45
		22 x 25	0.55	22 x 25	0.55	22 x 30	0.53		
						25 x 25	0.53		
82	826	20 x 30	0.64	20 x 35	0.64	20 x 35	0.64	22 x 35	0.54
		22 x 25	0.64	22 x 25	0.64	22 x 30	0.64		
						25 x 25	0.64		
100	107	20 x 35	0.70	20 x 35	0.70	22 x 30	0.65	22 x 35	0.56
		22 x 30	0.70	22 x 30	0.70	25 x 25	0.64		
		25 x 25	0.70	25 x 25	0.70	30 x 25	0.72		
120	127	20 x 40	0.75	20 x 40	0.75	22 x 40	0.80	22 x 40	0.64
		22 x 30	0.70	22 x 30	0.70	25 x 30	0.80		
				30 x 25	0.78	30 x 25	0.80		
150	157	22 x 40	0.88	22 x 40	0.88	22 x 40	0.84	25 x 40	0.76
		25 x 30	0.83	25 x 35	0.88	25 x 35	0.88		
		30 x 25	0.88	30 x 25	0.88	30 x 30	0.88		
180	187	22 x 40	0.93	22 x 40	0.90	25 x 40	1.00	30 x 35	0.86
		25 x 35	0.98	25 x 35	0.92				
				30 x 30	0.98	30 x 30	0.96		
		30 x 30	0.98			35 x 25	0.94		
220	227	22 x 45	1.05	22 x 45	1.05	25 x 45	1.12	30 x 40	0.97
		25 x 35	1.04	30 x 30	1.03	30 x 35	1.12		
		30 x 30	1.10	35 x 25	1.10	35 x 30	1.12		
270	277	25 x 50	1.29	25 x 50	1.37	30 x 40	1.28	30 x 45	1.12
		30 x 35	1.22	30 x 35	1.18				
		35 x 30	1.22	35 x 30	1.22	35 x 35	1.28		
330	337	30 x 45	1.55	30 x 45	1.49	30 x 45	1.39		
		35 x 30	1.44	35 x 30	1.36	35 x 40	1.45		
390	397	30 x 45	1.60	30 x 45	1.60	35 x 40	1.55		
		35 x 35	1.60	35 x 40	1.66				
470	477	35 x 40	1.90	35 x 40	1.81	35 x 50	1.85		
560	567	35 x 45	2.12						

Maximum Allowable Ripple Current (Arms) at 105°C 120Hz

Case Size Φ D x L (mm)



FEATURES

- Doesn't spark with DC over voltage.
- Load life: 2,000 hours at 105°C.

SPECIFICATIONS

Item	Performance Characteristics				
Operating Temperature Range	-25 to +105°C				
Rated Working Voltage Range	200 to 450V				
Nominal Capacitance Range	56 to 1200µF				
Capacitance Tolerance	±20% at 120Hz, +20°C				
Leakage Current	$I \leq 3\sqrt{CV}$ (µA) after 5 minutes application of rated working voltage at +20°C				
tan δ (120Hz, +20°C)	Working Voltage (V)	200	250	400	450
	tan δ (max.)	0.15	0.15	0.20	0.20
Low Temperature Characteristics	Impedance ratio max. at 120Hz				
	Rated Voltage (V)	200	250	400	450
	Z-25°C / Z+20°C	8	8	8	8
High Temperature Loading	Test time	: 2,000 hours			Post test requirements at +20°C
	Test temperature	: +105°C			Leakage current : ≤Initial specified value
	Test conditions	: Rated DC working voltage with rated ripple current			Cap. change : within ±20% of the initial measured value
					tan δ : ≤200% of the initial specified value
Shelf Life	At +105°C no voltage applied after 1,000 hours and then being stabilized at +20°C the capacitors shall meet the following limits				
	Leakage current	: ≤Initial specified value			
	Cap. change	: within ±15% of the initial measured value			
	tan δ	: ≤150% of the initial specified value			
Industrial Standard	JIS C - 5101-4 (IEC 60384-4)				

RIPPLE CURRENT MULTIPLIER

Frequency Coefficient

Coefficient Rated Voltage	Freq. (Hz)	60	120	1k	10k~50k
		200~250V	0.80	1.00	1.25
400~450V	0.80	1.00	1.30	1.47	

PART NUMBER SYSTEM (EXAMPLE : 200V 220µF)

1	2 3	4 5 6	7	8 9	10	11 12	13 14
E	UP	227	M	2D	N	25	SW

Type (Terminal Code)
 Case Length (25mm)
 Diameter (22mm)
 Voltage (200V)
 Tolerance (±20%)
 Capacitance (220µF)
 Series
 E-CAP

STANDARD RATINGS

Voltage (Code)		200V (2D)		250V (2E)		400V (2G)		450V (2W)	
Cap. (μF)	Code	Case Size	Ripple Current	Case Size	Ripple Current	Case Size	Ripple Current	Case Size	Ripple Current
56	566					22 x 25	0.45		
68	686					22 x 25	0.51		
82	856					22 x 30	0.58		
100	107					22 x 30	0.66		
120	127			22 x 25	0.68	22 x 35	0.76		
						25 x 30	0.76		
150	157					22 x 40	0.85		
						25 x 35	0.85		
						30 x 30	0.85		
180	187	22 x 25	0.82	22 x 30	0.87	22 x 45	0.94	30 x 35	1.00
				25 x 25	0.93	25 x 40	0.95		
						30 x 30	0.95		
220	227	22 x 25	0.90	22 x 30	1.00	25 x 40	1.24	30 x 40	1.20
						30 x 35	1.24		
						35 x 30	1.24		
270	277	22 x 30	1.02	22 x 35	1.14	25 x 50	1.30		
				25 x 30	1.13	30 x 40	1.30		
				30 x 25	1.25	35 x 30	1.30		
330	337	22 x 35	1.20	22 x 40	1.28	30 x 45	1.47		
		25 x 30	1.20	25 x 35	1.29	35 x 35	1.47		
390	397	22 x 35	1.35	22 x 45	1.42			35 x 45	1.60
		25 x 30	1.35	25 x 40	1.46				
				30 x 30	1.52				
470	477	22 x 40	1.45	25 x 45	1.64				
		25 x 35	1.45						
		30 x 30	1.47	30 x 35	1.67				
560	567	22 x 45	1.62	25 x 50	1.82				
		25 x 35	1.60	30 x 40	1.87				
		30 x 30	1.60	35 x 30	1.99				
		25 x 40	1.82	30 x 45	2.12				
680	687	30 x 35	1.81	35 x 35	2.19				
		35 x 30	1.86						
820	827	25 x 50	2.11	30 x 50	2.39				
		30 x 40	2.11						
		35 x 30	2.11	35 x 40	2.42				
1000	108	30 x 45	2.40						
		35 x 35	2.40						
1200	128	30 x 50	2.69						
		35 x 40	2.65						

Maximum Allowable Ripple Current (Arms) at 105°C 120Hz

Case Size $\Phi D \times L$ (mm)

DC OVERVOLTAGE TEST CONDITIONS

The vent will operate and the capacitor shall become an open circuit without burning materials when the following test DC voltage is applied.

- Test DC voltage

Rated voltage	Normal Capacitance	Current Limit	Test Voltage
200Vdc	<330	4A	300/375Vdc
	330μF ≤ C < 470μF	5A	
	≥470μF	7A	
250Vdc	<330μF	4A	350/450Vdc
	330μF ≤ C < 470μF	5A	
	<470μF	7A	
400Vdc	<100μF	2A	500/600Vdc
	100μF ≤ C < 220μF	4A	
	≥220μF	7A	
450Vdc	<100μF	2A	550/675Vdc
	100μF ≤ C < 220μF	4A	
	≥220μF	7A	

• Test circuit



Constant DC voltage/current power supply

Specifications are subject to change without notice. Should a safety or technical concern arise regarding the product, please be sure to contact our sales offices or agents immediately.

FEATURES

- Highly reliable capacitors that withstand under high ripple current.
- Two or three dimensions with same ratings.
- Aluminum case designed explosion-proof vent.
- Best for switching power supplies.
- Load life: 3,000 hours.



SPECIFICATIONS

Item	Performance Characteristics								
Operating Temperature Range	-40 to +105°C	-25 to +105°C							
Rated Working Voltage Range	10 to 100V	160 to 450V							
Nominal Capacitance Range	47 to 56000µF								
Capacitance Tolerance	±20% at 120Hz, +20°C								
Leakage Current	$I \leq 3\sqrt{CV}$ (µA) after 5 minutes application of rated working voltage at +20°C								
tan δ (120Hz, +20°C)	Working Voltage (V)	10 16 25 35 50 63 80 100							
	tan δ (max.)	0.55 0.50 0.45 0.40 0.35 0.30 0.25 0.20							
	Working Voltage (V)	160~220 250 315~450							
	tan δ (max.)	0.15 0.15 0.25							
	For capacitance value >33000µF, add following calculated value: $\frac{(\text{rated capacitance}) - 33000\mu\text{F}}{10000\mu\text{F}} \times 0.1$								
Low Temperature Characteristics	Impedance ratio max. at 120Hz								
	Working Voltage (V)	10	16	25	35	50	63	80	100
	Z-25°C / Z+20°C	6	6	6	6	4	3	3	3
	Z-40°C / Z+20°C	15	15	15	15	15	15	15	15
	Working Voltage (V)	160	200~220	250	315~385	400~420	450		
	Z-25°C / Z+20°C	8	8	8	8	8	8		
High Temperature Loading	Test time	: 3,000 hours			Post test requirements at +20°C				
	Test temperature	: +105°C			Leakage current : ≤Initial specified value				
	Test conditions	: Rated DC working voltage with rated ripple current			Cap. change : within ±20% of the initial measured value				
					tan δ : ≤200% of the initial specified value				
Shelf Life	At +105°C no voltage applied after 1,000 hours and then being stabilized at +20°C the capacitors shall meet the following limits								
	Leakage current : ≤Initial specified value								
	Cap. change : within ±15% of the initial measured value								
	tan δ : ≤150% of the initial specified value								
Industrial Standard	JIS C - 5101-4 (IEC 60384-4)								

RIPPLE CURRENT MULTIPLIER

Frequency Coefficient

Coefficient	Freq. (Hz)	Rated Voltage			
		60	120	1k	10k~50k
10~100V		0.90	1.00	1.15	1.25
160~250V		0.80	1.00	1.25	1.47
315~450V		0.80	1.00	1.30	1.47

PART NUMBER SYSTEM (EXAMPLE : 400V 100µF)

1	23	456	7	89	10	1112	1314	
E	KP	107	M	2G	O	25	S W	

Type (Terminal Code)
 Case Length (25mm)
 Diameter (25mm)
 Voltage (400V)
 Tolerance (±20%)
 Capacitance (100µF)
 Series
 E-CAP

STANDARD RATINGS

Voltage (Code)		10V (1A)		16V (1C)		25V (1E)		35V (1V)		
Cap. (µF)	Code	Case Size	Ripple Current	Case Size	Ripple Current	Case Size	Ripple Current	Case Size	Ripple Current	
2700	278							20 x 25	1.62	
3300	338							20 x 30	1.94	
								22 x 25	1.90	
3900	398					20 x 25	1.72	20 x 35	2.02	
								22 x 30	2.00	
4700	478					20 x 30	2.04	20 x 40	2.21	
								22 x 35	2.20	
						22 x 25	2.00	25 x 25	2.20	
5600	568			20 x 25	1.89	20 x 35	2.23	22 x 35	2.40	
						22 x 30	2.20	25 x 30	2.40	
6800	688	20 x 25	1.41	20 x 30	2.25	20 x 40	2.72	22 x 40	2.60	
				22 x 25	2.20	22 x 30	2.40	25 x 35	2.60	
						25 x 25	2.40	30 x 25	2.78	
8200	828	20 x 30	1.67	20 x 35	2.43	22 x 35	2.70	22 x 50	2.90	
				22 x 30	2.40	25 x 30	2.70	25 x 40	2.90	
						30 x 25	2.70	30 x 30	2.90	
10000	109	20 x 30	1.88	20 x 40	2.79	22 x 40	3.00	25 x 45	3.20	
				22 x 30	2.60	25 x 35	3.00	30 x 35	3.20	
				22 x 25	1.80	25 x 25	2.60	30 x 30	3.00	
12000	129	20 x 35	2.23	22 x 35	2.90	22 x 50	3.20	25 x 50	3.50	
				22 x 30	2.20	25 x 40	3.20	30 x 40	3.50	
				25 x 25	2.20	30 x 30	3.20	35 x 30	3.50	
15000	159	20 x 40	2.31	22 x 40	3.20	25 x 45	3.60	30 x 45	3.90	
				22 x 35	2.30	30 x 35	3.60	35 x 35	3.90	
				25 x 25	2.30	30 x 25	3.11	35 x 30	3.60	
18000	189	22 x 40	2.52	22 x 45	3.50	30 x 40	3.90	35 x 40	4.51	
				25 x 30	2.40	25 x 40	3.50	35 x 35	3.90	
				30 x 25	2.49	30 x 30	3.50	35 x 35	3.90	
22000	229	22 x 45	2.60	25 x 45	3.80	30 x 45	4.30	35 x 45	5.24	
				25 x 35	2.60	30 x 30	3.80	35 x 35	4.30	
				30 x 25	2.60	35 x 30	3.80	35 x 35	4.30	
27000	279	22 x 45	3.19	25 x 50	4.20					
				25 x 40	3.10	30 x 35	4.20	35 x 45	4.80	
				30 x 30	3.10	35 x 30	4.20			
33000	339	25 x 45	3.40	30 x 40	4.70					
				30 x 35	3.40			35 x 50	5.55	
				35 x 30	3.40	35 x 35	4.70			
39000	399	30 x 40	3.79	30 x 45	4.90					
				35 x 30	3.70	35 x 40	5.10			
47000	479	30 x 45	4.26	30 x 50	5.27					
				35 x 35	4.20	35 x 45	5.50			
56000	569	35 x 40	5.00							

Maximum Allowable Ripple Current (Arms) at 105°C 120Hz

Case Size Φ D x L (mm)

Specifications are subject to change without notice. Should a safety or technical concern arise regarding the product, please be sure to contact our sales offices or agents immediately.

STANDARD RATINGS

Voltage (Code)		50V (1H)		63V (1J)		80V (1K)		100V (2A)	
Cap. (μF)	Code	Case Size	Ripple Current	Case Size	Ripple Current	Case Size	Ripple Current	Case Size	Ripple Current
560	567							20 x 25	0.95
680	687							20 x 30	1.15
								22 x 25	1.09
820	827					20 x 25	1.04	20 x 35	1.31
								22 x 30	1.40
1000	108			20 x 25	1.21	20 x 30	1.24	20 x 35	1.43
						22 x 25	1.19	22 x 30	1.47
								25 x 25	1.45
1200	128			20 x 30	1.43	20 x 35	1.43	20 x 40	1.61
				22 x 25	1.40	22 x 30	1.50	22 x 35	1.69
								25 x 30	1.68
1500	158	20 x 25	1.29	20 x 35	1.52	20 x 35	1.57	22 x 40	1.97
				22 x 30	1.50	22 x 30	1.59	25 x 35	1.98
						25 x 25	1.59	30 x 25	1.95
1800	188	20 x 30	1.53	20 x 35	1.72	20 x 40	1.77	22 x 45	2.23
		22 x 25	1.50	22 x 30	1.70	22 x 35	1.79	25 x 40	2.20
				25 x 25	1.70	25 x 30	1.71	30 x 30	2.20
2200	228	20 x 35	1.72	20 x 40	2.01	22 x 40	2.03	25 x 45	2.53
		22 x 30	1.70	22 x 35	2.00	25 x 35	2.10	30 x 35	2.55
				25 x 30	2.00	30 x 25	1.98	35 x 30	2.60
2700	278	20 x 35	1.82	22 x 40	2.20	22 x 45	2.39	25 x 50	2.82
		22 x 30	1.80	25 x 35	2.20	25 x 40	2.35	30 x 40	2.86
		25 x 25	1.80	30 x 25	2.20	30 x 30	2.35	35 x 35	2.90
3300	338	20 x 40	2.01	22 x 45	2.60	25 x 45	2.64	30 x 45	3.30
		22 x 35	2.00	25 x 35	2.39	30 x 35	2.61	35 x 35	3.25
		25 x 30	2.00	30 x 30	2.50	35 x 30	2.60	35 x 35	3.25
3900	398	22 x 40	2.23	25 x 40	2.57	25 x 50	2.92	30 x 50	3.60
		25 x 30	2.20			30 x 40	2.82		
		30 x 25	2.20	30 x 35	2.70	35 x 30	2.97	35 x 40	3.67
4700	478	22 x 45	2.50	25 x 50	3.00	30 x 45	3.34		
		25 x 35	2.43	30 x 40	3.00			35 x 45	3.80
		30 x 30	2.50	35 x 30	3.00	35 x 35	3.38		
5600	568	22 x 50	2.80	30 x 40	3.22	30 x 50	3.80		
		25 x 40	2.80	35 x 35	3.30	35 x 40	3.80	35 x 50	4.05
		30 x 30	2.76						
6800	688	25 x 45	3.30	30 x 50	3.86				
		30 x 35	3.30	35 x 40	3.84	35 x 45	3.90		
		35 x 30	3.30						
8200	828	30 x 40	3.71	35 x 45	4.43	35 x 50	4.20		
		35 x 35	3.85						
10000	109	30 x 50	4.51	35 x 50	5.11				
		35 x 40	4.49						
12000	129	35 x 45	4.56						
15000	159	35 x 50	4.80						

Maximum Allowable Ripple Current (Arms) at 105°C 120Hz

Case Size Φ D x L (mm)

Specifications are subject to change without notice. Should a safety or technical concern arise regarding the product, please be sure to contact our sales offices or agents immediately.

STANDARD RATINGS

Voltage (Code)		160V (2C)		180V (2P)		200V (2D)		220V (2N)	
Cap. (µF)	Code	Case Size	Ripple Current	Case Size	Ripple Current	Case Size	Ripple Current	Case Size	Ripple Current
180	187							20 x 25	0.90
220	227			20 x 25	1.00	20 x 25	1.00	20 x 30 22 x 25	1.00 1.00
270	277	20 x 25	1.10	20 x 30 22 x 25	1.10 1.00	20 x 30 22 x 25	1.10 1.10	20 x 35 22 x 30	1.15 1.15
330	337	20 x 30 22 x 25	1.20 1.20	20 x 35 22 x 30	1.20 1.20	20 x 35 22 x 30 25 x 25	1.20 1.25 1.25	20 x 40 22 x 35 25 x 25	1.25 1.25 1.25
390	397	20 x 35 22 x 30	1.42 1.30	20 x 35 22 x 30 25 x 25	1.30 1.35 1.35	20 x 40 22 x 35 25 x 30	1.31 1.35 1.35	20 x 45 22 x 35 25 x 25	1.40 1.40 1.40
470	477	20 x 40 22 x 30 25 x 25	1.34 1.55 1.55	20 x 40 22 x 35 25 x 30	1.40 1.50 1.50	22 x 40 25 x 30 30 x 25	1.50 1.50 1.50	22 x 40 25 x 30 30 x 25	1.51 1.44 1.50
560	567	22 x 35 25 x 30	1.67 1.67	22 x 40 25 x 30 30 x 25	1.67 1.67 1.67	22 x 45 25 x 35 30 x 25	1.67 1.70 1.67	25 x 35 30 x 30 35 x 25	1.64 1.70 1.71
680	687	22 x 40 25 x 35 30 x 25	1.82 1.85 1.82	22 x 45 25 x 35 30 x 30	1.78 1.78 1.78	22 x 50 25 x 40 30 x 30	1.78 1.82 1.78	25 x 40 30 x 35 35 x 30	1.84 1.93 1.89
820	827	22 x 45 25 x 40 30 x 30	2.04 2.04 2.04	22 x 50 25 x 40 30 x 30	2.04 2.04 2.04	25 x 45 30 x 35 35 x 30	2.10 2.04 2.04	25 x 45 30 x 40 35 x 30	2.08 2.19 2.16
1000	108	25 x 45 30 x 35	2.40 2.25	25 x 45 30 x 35 35 x 30	2.30 2.30 2.30	25 x 50 30 x 40 35 x 35	2.42 2.30 2.30	30 x 45 35 x 35	2.50 2.44
1200	128	25 x 50 30 x 40 35 x 30	2.62 2.49 2.49	30 x 40 35 x 35	2.55 2.55	30 x 45 35 x 35	2.65 2.65	35 x 40	2.79
1500	158	30 x 45 35 x 35	2.84 2.84	30 x 45 35 x 40	2.90 2.90	35 x 40	3.08	35 x 45	3.22
1800	188	30 x 50 35 x 40	3.32 3.00	35 x 45	3.30	35 x 45	3.48		
2200	228	35 x 45	3.50	35 x 50	3.65				

Maximum Allowable Ripple Current (Arms) at 105°C 120Hz

Case Size Φ D x L (mm)

STANDARD RATINGS

Voltage (Code)		250V (2E)		315V (2F)		350V (2V)		385V (2Y)	
Cap. (μF)	Code	Case Size	Ripple Current	Case Size	Ripple Current	Case Size	Ripple Current	Case Size	Ripple Current
56	566							20 x 25	0.37
68	686					20 x 25	0.47	20 x 30 22 x 25	0.44 0.45
82	826			20 x 25	0.64	20 x 30	0.54	20 x 30 22 x 30	0.50 0.52
100	107			20 x 30	0.69	20 x 30 22 x 25	0.60 0.69	20 x 35 22 x 30 25 x 25	0.56 0.58 0.57
120	127			20 x 30 22 x 25	0.75 0.75	20 x 35 22 x 30 25 x 25	0.68 0.75 0.75	20 x 40 22 x 35 25 x 30	0.66 0.68 0.68
150	157	20 x 25	0.79	20 x 35 22 x 30 25 x 25	0.82 0.82 0.82	20 x 40 22 x 35 25 x 30	0.78 0.82 0.83	22 x 40 25 x 30 30 x 25	0.79 0.78 0.75
180	187	20 x 30 22 x 25	0.90 0.88	20 x 40 22 x 35 25 x 30	0.90 0.92 0.93	22 x 40 25 x 30 30 x 25	0.92 0.92 0.90	22 x 45 25 x 35 30 x 30	0.89 0.86 0.88
220	227	20 x 35 22 x 30 25 x 25	1.00 1.00 1.08	22 x 40 25 x 30 30 x 25	1.04 1.04 1.04	22 x 50 25 x 35 30 x 30	1.05 1.04 1.02	22 x 50 25 x 40 30 x 30	1.01 1.00 1.00
270	277	20 x 40 22 x 35 25 x 30	1.10 1.18 1.27	22 x 45 25 x 35 30 x 25	1.16 1.16 1.16	22 x 50 25 x 40 30 x 30	1.16 1.18 1.17	25 x 45 30 x 40 35 x 30	1.13 1.14 1.10
330	337	22 x 40 25 x 30 30 x 25	1.30 1.30 1.35	22 x 50 25 x 40 30 x 30	1.33 1.33 1.33	25 x 45 30 x 35 35 x 30	1.29 1.34 1.22	30 x 45 35 x 35	1.31 1.32
390	397	22 x 45 25 x 35 30 x 30	1.49 1.49 1.49	25 x 45 30 x 35 35 x 30	1.47 1.47 1.47	25 x 50 30 x 40 35 x 35	1.51 1.51 1.47	30 x 50 35 x 40	1.48 1.48
470	477	22 x 50 25 x 40 30 x 30	1.65 1.65 1.65	30 x 40 35 x 30	1.70 1.70	30 x 45 35 x 35	1.65 1.69	35 x 45	1.76
560	567	25 x 45 30 x 35 25 x 50	1.80 1.80 2.03	30 x 45 35 x 35	2.05 2.05	30 x 50 35 x 40	1.85 1.90	35 x 50	1.95
680	687	30 x 40 35 x 30	2.00 2.00	35 x 40	2.17	35 x 45	2.20		
820	827	30 x 45 35 x 35	2.30 2.30	35 x 45	2.20				
1000	108	30 x 50 35 x 40	2.70 2.69						
1200	128	35 x 45	3.09						

Maximum Allowable Ripple Current (Arms) at 105°C 120Hz

Case Size Φ D x L (mm)

Specifications are subject to change without notice. Should a safety or technical concern arise regarding the product, please be sure to contact our sales offices or agents immediately.

STANDARD RATINGS

Voltage (Code)		400V (2G)		420V (2M)		450V (2W)			
Cap. (μF)	Code	Case Size	Ripple Current	Case Size	Ripple Current	Case Size	Ripple Current		
47	476					20 x 25	0.39		
56	566	20 x 25	0.51	20 x 25	0.51	20 x 30	0.51		
						22 x 25	0.50		
68	686	20 x 30	0.56	20 x 30	0.56	20 x 35	0.56		
						22 x 30	0.53		
						25 x 25	0.53		
82	826	20 x 30	0.64	20 x 35	0.64	20 x 35	0.64		
						22 x 30	0.64		
						25 x 25	0.64		
100	107	20 x 35	0.70	20 x 35	0.70	22 x 35	0.69		
						22 x 30	0.70		
						25 x 25	0.70		
120	127	20 x 40	0.75	20 x 40	0.75	22 x 40	0.80		
						22 x 35	0.75		
						25 x 30	0.76		
150	157	22 x 40	0.88	22 x 40	0.88	22 x 45	0.88		
						25 x 30	0.83		
						30 x 25	0.88		
180	187	22 x 45	0.98	22 x 45	0.95	25 x 40	1.00		
								25 x 40	0.97
						25 x 35	0.98	30 x 30	0.96
220	227	30 x 30	0.98	30 x 30	0.94	30 x 30	1.00		
								22 x 50	1.10
								25 x 40	1.10
270	277	30 x 35	1.10	30 x 35	1.10	30 x 35	1.12		
								30 x 30	1.10
								35 x 25	1.10
330	337	25 x 50	1.29	25 x 50	1.37	30 x 40	1.28		
								30 x 35	1.22
								35 x 30	1.22
390	397	30 x 45	1.55	30 x 45	1.49	30 x 50	1.45		
								35 x 30	1.44
470	477	30 x 45	1.60	30 x 50	1.67	35 x 40	1.55		
								35 x 35	1.60
560	567	35 x 45	2.12						

Maximum Allowable Ripple Current (Arms) at 105°C 120Hz

Case Size ΦD x L (mm)

FEATURES

- High ripple current.
- Two or three dimensions with same ratings.
- Aluminum case designed explosion-proof vent.
- Best for switching power supplies.
- Load life with ripple current : 105°C 5,000 hours.

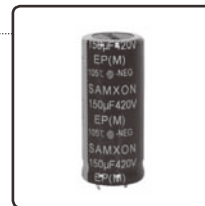

SPECIFICATIONS

Item	Performance Characteristics						
Operating Temperature Range	-40 to +105°C			-25 to +105°C			
Rated Working Voltage Range	10 to 100V			160 to 450V			
Nominal Capacitance Range	82 to 47000µF						
Capacitance Tolerance	±20% at 120Hz, +20°C						
Leakage Current	I ≤ 3√CV (µA) after 5 minutes application of rated working voltage at +20°C						
tan δ (120Hz, +20°C)	Working Voltage (V)	10	16	25	35	50	63~100
	tan δ (max.)	0.60	0.45	0.30	0.25	0.20	0.15
	Working Voltage (V)	160~400	420~450				
	tan δ (max.)	0.15	0.20				
For capacitance value >33000µF, add following calculated value: $\frac{(\text{rated capacitance}) - 33000\mu\text{F}}{10000\mu\text{F}} \times 0.1$							
Low Temperature Characteristics	Impedance ratio max. at 120Hz						
	Working Voltage (V)	10	16	25	35	50	63~100
	Z-25°C / Z+20°C	6	6	6	6	4	3
	Z-40°C / Z+20°C	15	15	15	15	15	15
	Working Voltage (V)	160	250	315	350	400~420	450
	Z-25°C / Z+20°C	8	8	8	8	8	8
High Temperature Loading	Test time : 5,000 hours						Post test requirements at +20°C
	Test temperature : +105°C						Leakage current : ≤Initial specified value
	Test conditions : Rated DC working voltage with rated ripple current						Cap. change : within ±20% of the initial measured value
							tan δ : ≤200% of the initial specified value
Shelf Life	At +105°C no voltage applied after 1,000 hours and then being stabilized at +20°C the capacitors shall meet the following limits						
	Leakage current : ≤Initial specified value						Cap. change : within ±15% of the initial measured value
	tan δ : ≤150% of the initial specified value						
Industrial Standard	JIS C - 5101-4 (IEC 60384-4)						

RIPPLE CURRENT MULTIPLIER

Frequency Coefficient

Coefficient	Freq. (Hz)	60	120	1k	10k~50k
Rated Voltage	10~100V	0.90	1.00	1.15	1.25
	160~250V	0.80	1.00	1.25	1.47
	315~450V	0.80	1.00	1.30	1.47

PART NUMBER SYSTEM (EXAMPLE : 160V 2200µF)

1	2 3	4 5 6	7	8 9	10	11 12	13 14
E	EP	228	M	2C	Q	45	SW

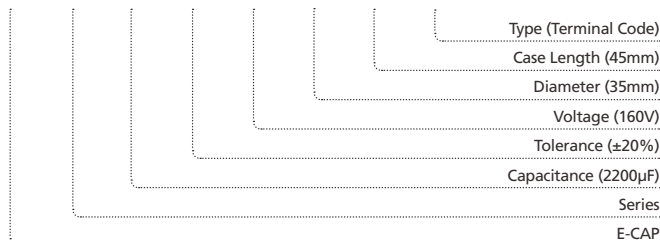

STANDARD RATINGS

Voltage (Code)		10V (1A)		16V (1C)		25V (1E)		35V (1V)	
Cap. (µF)	Code	Case Size	Ripple Current	Case Size	Ripple Current	Case Size	Ripple Current	Case Size	Ripple Current
2200	228							22 x 25	1.10
3300	338							22 x 30	1.42
								25 x 25	1.41
3900	398					22 x 25	1.31	22 x 35	1.58
								25 x 30	1.58
4700	478					22 x 30	1.51	22 x 40	1.78
						25 x 25	1.51	30 x 25	1.77
5600	568							25 x 35	1.98
				22 x 25	1.44	22 x 35	1.70	30 x 30	1.98
								35 x 25	2.03
6800	688	22 x 25	1.30	22 x 30	1.66	22 x 40	1.92	22 x 50	2.26
				25 x 25	1.66	25 x 30	1.87	25 x 40	2.24
						30 x 25	1.90	25 x 50	2.57
8200	828			22 x 35	1.87	25 x 35	2.14	25 x 50	2.57
						30 x 30	2.15	30 x 35	2.50
						35 x 25	2.19	35 x 30	2.55
10000	109	22 x 30	1.65	22 x 40	2.12	22 x 50	2.45	30 x 40	2.86
				25 x 30	2.07				
		25 x 25	1.64	30 x 25	2.11	25 x 40	2.43	35 x 35	2.88
12000	129	22 x 35	1.85	25 x 35	2.37	25 x 50	2.78	30 x 50	3.32
		25 x 30	1.85	30 x 30	2.37	30 x 35	2.70	35 x 40	3.30
		30 x 25	1.89	35 x 25	2.42	35 x 30	2.76		
15000	159	22 x 40	2.12	22 x 50	2.74	30 x 40	3.13		
		25 x 35	2.16	25 x 40	2.71	35 x 35	3.16		
18000	189	22 x 50	2.45	25 x 50	3.11	30 x 50	3.64	35 x 50	4.29
		25 x 40	2.43						
		30 x 30	2.37	30 x 35	3.02	35 x 40	3.61		
		35 x 25	2.42	35 x 30	3.09				
22000	229	30 x 35	2.73	30 x 40	3.46				
		35 x 30	2.79	35 x 35	3.49				
27000	279	25 x 50	3.11	30 x 50	4.07	35 x 50	4.70		
		30 x 40	3.13	35 x 40	4.04				
33000	339	35 x 35	3.49						
39000	399	30 x 50	3.99	35 x 50	5.16				
		35 x 40	3.96						
47000	479	35 x 50	4.62						

Maximum Allowable Ripple Current (Arms) at 105°C 120Hz

Case Size $\Phi D \times L$ (mm)

STANDARD RATINGS

Voltage (Code)		50V (1H)		63V (1J)		80V (1K)		100V (2A)	
Cap. (μF)	Code	Case Size	Ripple Current	Case Size	Ripple Current	Case Size	Ripple Current	Case Size	Ripple Current
390	397							22 x 25	0.78
560	567							22 x 30	0.99
								25 x 25	0.98
680	687					22 x 25	0.97	22 x 35	1.12
								22 x 40	1.26
820	827					22 x 30	1.12	25 x 30	1.23
								30 x 25	1.25
1000	108			22 x 25	1.00	22 x 35	1.70	25 x 35	1.41
						25 x 25	1.92	30 x 30	1.42
								35 x 25	1.45
1200	128			22 x 30	1.15	22 x 40	1.42	22 x 50	1.60
						25 x 30	1.39	25 x 40	1.59
				25 x 25	1.15	30 x 25	1.41	30 x 35	1.61
1500	158	22 x 25	1.02	22 x 35	1.32	25 x 35	1.62	25 x 50	1.86
								30 x 40	1.87
								35 x 30	1.85
1800	188	22 x 30	1.17	22 x 40	1.49	22 x 50	1.84		
				25 x 30	1.45	25 x 40	1.82	35 x 35	2.07
		25 x 25	1.17	30 x 25	1.48	30 x 30	1.78		
						35 x 25	1.82		
2200	228	22 x 35	1.33	25 x 35	1.67	25 x 50	2.11	30 x 50	2.40
				30 x 30	1.68	30 x 35	2.05		
				35 x 25	1.71	35 x 30	2.09	35 x 40	2.39
2700	278	22 x 40	1.51	22 x 50	1.92	30 x 40	2.35		
		25 x 30	1.47	25 x 40	1.90			35 x 50	2.81
		30 x 25	1.50	30 x 35	1.93	35 x 35	2.37		
3300	338	25 x 35	1.70	25 x 50	2.20	30 x 50	2.75		
		30 x 30	1.70						
		35 x 25	1.74	35 x 30	2.18	35 x 40	2.73		
3900	398	22 x 50	1.91	30 x 40	2.41				
		25 x 40	1.89	35 x 35	2.43				
4700	478	30 x 35	2.11	30 x 50	2.80	35 x 50	3.46		
		35 x 30	2.16	35 x 40	2.78				
5600	568	25 x 50	2.38						
		30 x 40	2.39						
		35 x 35	2.41						
6800	688	30 x 50	2.79	35 x 50	3.55				
		35 x 40	2.78						
10000	109	35 x 50	3.57						

Maximum Allowable Ripple Current (Arms) at 105°C 120Hz

Case Size ΦD x L (mm)

Specifications are subject to change without notice. Should a safety or technical concern arise regarding the product, please be sure to contact our sales offices or agents immediately.

STANDARD RATINGS

Voltage (Code)		160V (2C)		200V (2D)		250V (2E)		315V (2F)	
Cap. (µF)	Code	Case Size	Ripple Current	Case Size	Ripple Current	Case Size	Ripple Current	Case Size	Ripple Current
150	157							22 x 30	0.86
180	187							22 x 35	0.98
								25 x 30	1.01
220	227					22 x 30	1.09	22 x 40	1.10
								30 x 25	1.17
270	277			22 x 25	1.10	22 x 35	1.28	22 x 45	1.24
								25 x 35	1.27
330	337					25 x 30	1.42	22 x 50	1.39
								25 x 40	1.45
								30 x 30	1.40
390	397	22 x 30	1.42	22 x 35	1.47	22 x 45	1.61	25 x 45	1.60
				25 x 30	1.50	25 x 35	1.53		
						30 x 30	1.62		
470	477			22 x 40	1.64	22 x 50	1.79	25 x 50	1.78
								30 x 40	1.81
								35 x 30	1.82
560	567	22 x 35	1.77	22 x 45	1.82	25 x 45	1.98	30 x 45	2.02
		25 x 30	1.81	25 x 35	1.82	30 x 35	1.95	35 x 35	2.00
				30 x 25	1.78				
680	687	22 x 40	1.98	22 x 50	1.90	25 x 50	2.21	30 x 50	2.21
		25 x 35	2.01	25 x 40	1.98	30 x 40	2.18	35 x 40	2.29
		30 x 25	1.96	30 x 30	1.98	35 x 30	2.15		
820	827	22 x 45	2.20	25 x 45	2.20	30 x 45	2.45	35 x 45	2.57
				30 x 35	2.22	35 x 35	2.38		
				25 x 45	2.65	25 x 50	2.46		
1000	108	30 x 35	2.55	30 x 40	2.53	35 x 40	2.72	35 x 50	2.89
		35 x 25	2.55	35 x 35	2.77				
		25 x 50	2.93	30 x 45	2.84				
1200	128	30 x 40	2.84	35 x 35	2.88	35 x 45	3.05		
		35 x 30	2.86						
		30 x 45	3.17	35 x 40	3.34			35 x 50	3.49
35 x 35	3.22								
1800	188	30 x 50	3.53	35 x 45	3.74				
		35 x 40	3.66						
2200	228	35 x 45	4.14						
2700	278	35 x 50	4.68						

Maximum Allowable Ripple Current (Arms) at 105°C 120Hz

Case Size $\Phi D \times L$ (mm)

STANDARD RATINGS

Voltage (Code)		350V (2V)		400V (2G)		420V (2M)		450V (2W)	
Cap. (μF)	Code	Case Size	Ripple Current	Case Size	Ripple Current	Case Size	Ripple Current	Case Size	Ripple Current
82	826							22 x 30	0.64
100	107			22 x 30	0.71	22 x 30	0.71	22 x 35 25 x 30	0.74 0.75
120	127	22 x 30	0.78	22 x 35	0.80	22 x 35 25 x 30	0.80 0.83	22 x 40	0.82
150	157	22 x 35	0.90	22 x 40 25 x 35	0.91 0.99	22 x 40	0.91	22 x 45 25 x 35 30 x 30	0.93 0.94 1.00
180	187	25 x 30	1.01	22 x 45 25 x 35 30 x 30	1.01 1.03 1.10	22 x 45 25 x 40 30 x 30	1.01 1.10 1.10	22 x 50 25 x 40 30 x 30	1.01 1.03 1.03
220	227	22 x 45 25 x 35 30 x 30	1.16 1.14 1.21	22 x 50 25 x 40	1.14 1.19	25 x 45 30 x 35 35 x 25	1.20 1.21 1.22	25 x 45 30 x 35 35 x 30	1.16 1.17 1.24
270	277	22 x 50 25 x 40 30 x 30	1.26 1.31 1.27	25 x 50 30 x 35	1.39 1.35	25 x 50 30 x 40 35 x 30	1.35 1.37 1.38	25 x 50 30 x 40 35 x 35	1.31 1.33 1.39
330	337	25 x 45 30 x 35	1.46 1.43	30 x 45 35 x 30	1.59 1.52	30 x 45 35 x 35	1.50 1.54	30 x 50	1.58
390	397	25 x 50 30 x 40 35 x 35	1.62 1.60 1.76	30 x 45 35 x 35	1.68 1.67	30 x 50 35 x 40	1.72 1.73	35 x 40	1.73
470	477	30 x 45 35 x 35	1.81 1.83	30 x 50 35 x 40	1.89 1.90	35 x 45	1.94	35 x 50	1.98
560	567	30 x 50 35 x 40	2.00 2.07	35 x 45	2.12	35 x 50	2.17		
680	687	35 x 45	2.34	35 x 50	2.39				
820	827	35 x 50	2.62						

Maximum Allowable Ripple Current (Arms) at 105°C 120Hz

Case Size ΦD x L (mm)

Specifications are subject to change without notice. Should a safety or technical concern arise regarding the product, please be sure to contact our sales offices or agents immediately.

FEATURES

- High ripple current and high reliability.
- Low equivalent series resistance ESR.
- Different case sizes available for each capacitance value.
- Load life with ripple current : 5,000 hours.



SPECIFICATIONS

Item	Performance Characteristics							
Operating Temperature Range	-40 to +105°C	-25 to +105°C						
Rated Working Voltage Range	10 to 100V	200 to 450V						
Nominal Capacitance Range	100 to 33000µF							
Capacitance Tolerance	±20% at 120Hz, +20°C							
Leakage Current	$I \leq 3\sqrt{CV}$ (µA) after 5 minutes application of rated working voltage at +20°C							
tan δ (120Hz, +20°C)	Working Voltage (V)	10 16 25 35 50 63~100 200~400 450						
	tan δ (max.)	0.60 0.45 0.30 0.25 0.20 0.15 0.15 0.20						
Low Temperature Characteristics	Impedance ratio max. at 120Hz							
	Working Voltage (V)	10	16	25	35	50	63~100	200~400
	Z-25°C / Z+20°C	6	6	6	6	6	4	3
	Z-40°C / Z+20°C	15	15	15	15	15	15	15
High Temperature Loading	Working Voltage (V)	200	250	400	450			
	Z-25°C / Z+20°C	8	8	8	8			
Shelf Life	Test time	: 5,000 hours			Post test requirements at +20°C			
	Test temperature	: +105°C			Leakage current : ≤Initial specified value			
Industrial Standard	Test conditions	: Rated DC working voltage with rated ripple current			Cap. change : within ±20% of the initial measured value			
					tan δ : ≤200% of the initial specified value			
Shelf Life	At +105°C no voltage applied after 1,000 hours and then being stabilized at +20°C the capacitors shall meet the following limits							
	Leakage current	: ≤Initial specified value						
	Cap. change	: within ±15% of the initial measured value						
Shelf Life	tan δ	: ≤150% of the initial specified value						
	Industrial Standard	JIS C - 5101-4 (IEC 60384-4)						

RIPPLE CURRENT MULTIPLIER

Frequency Coefficient

Coefficient	Freq. (Hz)	60	120	1k	10k~50k
	10~100V	0.90	1.00	1.15	1.25
	160~250V	0.80	1.00	1.25	1.47
	315~450V	0.80	1.00	1.30	1.47

PART NUMBER SYSTEM (EXAMPLE : 250V 330µF)

1	2 3	4 5 6	7	8 9	10	11 12	13 14
E	FP	337	M	2 E	P	3 0	S W

Type (Terminal Code)
 Case Length (30mm)
 Diameter (30mm)
 Voltage (250V)
 Tolerance (±20%)
 Capacitance (330µF)
 Series
 E-CAP

STANDARD RATINGS

Voltage (Code)		10V (1A)			16V (1C)			25V (1E)		
Cap. (μF)	Code	Case Size	Impedance	Ripple Current	Case Size	Impedance	Ripple Current	Case Size	Impedance	Ripple Current
4700	478							22 x 30	57	1.6
								25 x 25	57	1.6
6800	688	22 x 25	78	1.4	22 x 30	49	1.8	25 x 30	43	1.9
10000	109	22 x 30	56	1.8	25 x 30	36	2.2	25 x 40	32	2.5
15000	159	22 x 40	39	2.3	25 x 40	26	2.8	30 x 40	23	3.2
22000	229	30 x 35	28	3.0	30 x 40	18	3.5			
33000	339	30 x 45	20	3.9						

Maximum Allowable Ripple Current (Arms) at 105°C 120Hz
Maximum Impedance (mΩ) at 20°C 20kHz

Case Size ΦD x L (mm)

Voltage (Code)		35V (1V)			50V (1H)			63V (1J)		
Cap. (μF)	Code	Case Size	Impedance	Ripple Current	Case Size	Impedance	Ripple Current	Case Size	Impedance	Ripple Current
1000	108							22 x 25	159	1.0
1500	158							22 x 35	106	1.4
2200	228	22 x 25	90	1.1	22 x 35	90	1.4	25 x 35	72	1.7
								30 x 30	85	1.8
3300	338	22 x 30	60	1.5	25 x 35	60	1.8	30 x 40	56	2.3
		25 x 25	60	1.5						
4700	478	22 x 40	48	1.9	30 x 35	45	2.2	35 x 35	45	2.7
6800	688	25 x 40	37	2.3	30 x 50	35	2.9	35 x 50	31	3.6
10000	109	30 x 40	28	2.9	35 x 45	26	3.6			
15000	159	35 x 40	20	3.8						
18000	189	35 x 45	18	4.3						

Maximum Allowable Ripple Current (Arms) at 105°C 120Hz
Maximum Impedance (mΩ) at 20°C 20kHz

Case Size ΦD x L (mm)

Voltage (Code)		80V (1K)			100V (2A)			200V (2D)		
Cap. (μF)	Code	Case Size	Impedance	Ripple Current	Case Size	Impedance	Ripple Current	Case Size	Impedance	Ripple Current
220	227							22 x 30	700	0.96
330	337							22 x 40	470	1.3
470	477							25 x 40	330	1.7
								30 x 30	330	1.7
560	567				25 x 25	190	1.0			
680	687				22 x 35	156	1.2	30 x 40	230	2.2
1000	108	25 x 25	133	1.3	25 x 35	106	1.4	35 x 45	160	3.1
					30 x 30	106	1.5			
1200	128	30 x 25	110	1.5						
1500	158	25 x 35	89	1.8	30 x 40	70	1.9	35 x 50	110	3.9
2200	228	30 x 35	60	2.0	30 x 50	60	2.3			
3300	338	35 x 35	48	2.8	35 x 50	40	3.0			
4700	478	35 x 45	34	3.4						

Maximum Allowable Ripple Current (Arms) at 105°C 120Hz
Maximum Impedance (mΩ) at 20°C 20kHz

Case Size ΦD x L (mm)

Voltage (Code)		250V (2E)			400V (2G)			450V (2W)		
Cap. (μF)	Code	Case Size	Impedance	Ripple Current	Case Size	Impedance	Ripple Current	Case Size	Impedance	Ripple Current
100	107				25 x 30	1090	0.7	22 x 45	1600	0.75
								30 x 30	1600	0.76
150	157				25 x 40	730	0.95	25 x 45	1070	1.0
					30 x 30	730	0.94	30 x 35	1070	0.99
220	227	25 x 30	700	1.0	30 x 40	500	1.3	30 x 45	730	1.3
					35 x 30	500	1.3	35 x 35	730	1.3
330	337	25 x 40	470	1.4	30 x 50	330	1.7	35 x 50	490	1.8
		30 x 30	470	1.4	35 x 40	330	1.7			
390	397				35 x 45	280	1.9	35 x 50	410	2.0
470	477	30 x 35	330	1.8	35 x 50	240	2.2			
680	687	30 x 45	230	2.3						
1000	108	35 x 45	160	3.1						

Maximum Allowable Ripple Current (Arms) at 105°C 120Hz
Maximum Impedance (mΩ) at 20°C 20kHz

Case Size ΦD x L (mm)

Specifications are subject to change without notice. Should a safety or technical concern arise regarding the product, please be sure to contact our sales offices or agents immediately.

FEATURES

- High ripple current and high reliability.
- Two or three dimensions with same ratings.
- Aluminum case designed explosion-proof vent.
- Best for ballast application.
- Load life with ripple current : 105°C 7,000 hours.



SPECIFICATIONS

Item	Performance Characteristics								
Operating Temperature Range	-40 to +105°C				-25 to +105°C				
Rated Working Voltage Range	160 to 250V				315 to 450V				
Nominal Capacitance Range	39 to 2200µF								
Capacitance Tolerance	±20% at 120Hz, +20°C								
Leakage Current	I ≤ 3√CV (µA) after 5 minutes application of rated working voltage at +20°C								
tan δ (120Hz, +20°C)	Working Voltage (V)	160	200	250	315	350	400	450	
	tan δ (max.)	0.15	0.15	0.15	0.15	0.15	0.15	0.20	
Low Temperature Characteristics	Impedance ratio max. at 120Hz								
	Working Voltage (V)	160~250			315~450				
	Z-25°C / Z+20°C	3			8				
High Temperature Loading	Test time : 7,000 hours				Post test requirements at +20°C				
	Test temperature : +105°C				Leakage current : ≤Initial specified value				
	Test conditions : Rated DC working voltage with rated ripple current				Cap. change : within ±20% of the initial measured value				
Shelf Life	At +105°C no voltage applied after 1,000 hours and then being stabilized at +20°C the capacitors shall meet the following limits								
	Leakage current : ≤Initial specified value				tan δ : ≤250% of the initial specified value				
	Cap. change : within ±15% of the initial measured value				tan δ : ≤150% of the initial specified value				
Industrial Standard	JIS C - 5101-4 (IEC 60384-4)								

RIPPLE CURRENT MULTIPLIER

Frequency Coefficient

Coefficient Rated Voltage	Freq. (Hz)	60	120	1k	10k~50k
		160~250V	0.80	1.00	1.25
315~450V	0.80	1.00	1.30	1.47	

PART NUMBER SYSTEM (EXAMPLE : 400V 100µF)



STANDARD RATINGS

Voltage (Code)		160V (2C)		200V (2D)		250V (2E)		315V (2F)	
Cap. (μF)	Code	Case Size	Ripple Current	Case Size	Ripple Current	Case Size	Ripple Current	Case Size	Ripple Current
82	826							22 x 25	0.64
100	107							22 x 30	0.69
120	127							22 x 30	0.75
								25 x 25	0.75
150	157							22 x 35	0.82
								25 x 30	0.82
								30 x 25	0.82
180	187					22 x 30	0.90	22 x 40	0.90
						25 x 25	0.90	30 x 25	0.90
220	227			22 x 25	1.00	22 x 30	1.00	22 x 45	1.00
						25 x 25	1.00	30 x 30	1.00
270	277	22 x 25	1.10	22 x 30	1.10	22 x 35	1.10	25 x 45	1.10
				25 x 25	1.10	25 x 30	1.10	30 x 35	1.10
						30 x 25	1.10	35 x 30	1.10
330	337	22 x 30	1.20	22 x 30	1.20	22 x 40	1.20	25 x 50	1.20
				25 x 25	1.20	25 x 35	1.20	30 x 40	1.20
						30 x 25	1.20	35 x 30	1.20
390	397	22 x 30	1.30	22 x 35	1.30	22 x 45	1.30	30 x 45	1.30
				25 x 25	1.30	25 x 30	1.30	25 x 35	1.30
						30 x 25	1.30	30 x 30	1.30
470	477	22 x 35	1.40	22 x 40	1.40	25 x 45	1.40	30 x 50	1.40
				25 x 30	1.40	25 x 35	1.40	30 x 35	1.40
						30 x 30	1.40	35 x 30	1.40
560	567	22 x 40	1.50	22 x 45	1.50	25 x 50	1.50	35 x 45	1.50
				25 x 30	1.50	25 x 35	1.50		
				30 x 25	1.50	30 x 30	1.50		
680	687	22 x 45	1.70	25 x 40	1.70	30 x 45	1.70	35 x 50	1.70
				25 x 35	1.70	25 x 40	1.70		
				30 x 30	1.70	30 x 35	1.70		
820	827	25 x 40	2.00	25 x 50	2.00	30 x 50	2.00		
				30 x 40	2.00	30 x 40	2.00		
				30 x 30	2.00	35 x 30	2.00		
1000	108	25 x 45	2.20	30 x 45	2.20	35 x 45	2.20		
		30 x 35	2.20	35 x 35	2.20				
1200	128	25 x 50	2.30	30 x 50	2.30	35 x 50	2.30		
		30 x 40	2.30	35 x 40	2.30				
		35 x 35	2.30						
1500	158	30 x 45	2.50	35 x 50	2.50				
		35 x 35	2.50						
1800	188	30 x 50	2.70						
		35 x 40	2.70						
2200	228	35 x 50	2.90						

Maximum Allowable Ripple Current (Arms) at 105°C 120Hz

Case Size ΦD x L (mm)

Specifications are subject to change without notice. Should a safety or technical concern arise regarding the product, please be sure to contact our sales offices or agents immediately.

STANDARD RATINGS

Voltage (Code)		350V (2V)		400V (2G)		450V (2W)	
Cap. (μF)	Code	Case Size	Ripple Current	Case Size	Ripple Current	Case Size	Ripple Current
39	396					22 x 25	0.37
47	476					22 x 30	0.40
56	566					22 x 35	0.47
						25 x 25	0.47
68	686					22 x 40	0.53
						25 x 30	0.53
82	826	22 x 25	0.64	22 x 35	0.64	22 x 45	0.56
				25 x 25	0.64	25 x 35	0.56
100	107	22 x 30	0.69	22 x 35	0.69	22 x 50	0.64
		25 x 25	0.69	25 x 30	0.69	25 x 40	0.64
120	127	22 x 35	0.75	22 x 40	0.75	30 x 30	0.64
		25 x 30	0.75	25 x 35	0.75	25 x 45	0.72
150	157	22 x 40	0.82	22 x 50	0.82	30 x 30	0.72
		25 x 30	0.82	25 x 40	0.82	25 x 50	0.79
		30 x 25	0.82	30 x 30	0.82	30 x 40	0.79
180	187	22 x 45	0.90	25 x 45	0.90	35 x 30	0.79
		25 x 35	0.90	30 x 35	0.90	30 x 45	0.87
		30 x 30	0.90	35 x 25	0.90	35 x 35	0.87
220	227	22 x 50	1.00	25 x 50	1.00	35 x 35	0.87
		25 x 40	1.00	30 x 40	1.00	30 x 50	1.00
		30 x 30	1.00	35 x 30	1.00	35 x 40	1.00
270	277	25 x 50	1.10	30 x 45	1.10	35 x 40	1.00
		30 x 35	1.10	35 x 35	1.10	35 x 45	1.19
		35 x 30	1.10				
330	337	30 x 45	1.20	30 x 50	1.20	35 x 50	1.38
		35 x 35	1.20	35 x 40	1.20		
390	397	30 x 50	1.30	35 x 45	1.30		
		35 x 40	1.30				
470	477	35 x 40	1.40	35 x 50	1.40		
560	567	35 x 50	1.50				

Maximum Allowable Ripple Current (Arms) at 105°C 120Hz

Case Size ΦD x L (mm)

Specifications are subject to change without notice. Should a safety or technical concern arise regarding the product, please be sure to contact our sales offices or agents immediately.

FEATURES

- Designed for withstanding vibration.
- Suited for washing machines and etc.



SPECIFICATIONS

Item	Performance Characteristics							
Operating Temperature Range	-40 to +105°C				-25 to +105°C			
Rated Working Voltage Range	10 to 100V				160 to 500V			
Nominal Capacitance Range	39 to 56000µF							
Capacitance Tolerance	±20% at 120Hz, +20°C							
Leakage Current	I ≤ 3√CV (µA) after 5 minutes application of rated working voltage at +20°C							
tan δ (120Hz, +20°C)	Working Voltage (V)	10	16	25	35	50	63	80
	tan δ (max.)	0.55	0.50	0.45	0.35	0.30	0.30	0.25
	Working Voltage (V)	100	160~250	315~450	500			
	tan δ (max.)	0.20	0.15	0.15	0.20			
For capacitance value >33000µF, add following calculated value: $\frac{(\text{rated capacitance}) - 33000\mu\text{F}}{10000\mu\text{F}} \times 0.1$								
Low Temperature Characteristics	Impedance ratio max. at 120Hz							
	Working Voltage (V)	10~25	35	50	63~100	160~250	315~450	500
	Z-25°C / Z+20°C	4	6	4	3	8	8	8
	Z-40°C / Z+20°C	15	15	15	15	-	-	-
High Temperature Loading	Test time	: 2,000 hours			Post test requirements at +20°C			
	Test temperature	: +105°C			Leakage current : ≤Initial specified value			
	Test conditions	: Rated DC working voltage with rated ripple current			Cap. change : within ±20% of the initial measured value			
					tan δ : ≤200% of the initial specified value			
Shelf Life	At +105°C no voltage applied after 1,000 hours and then being stabilized at +20°C the capacitors shall meet the following limits							
	Leakage current : ≤Initial specified value							
	Cap. change : within ±15% of the initial measured value							
	tan δ : ≤150% of the initial specified value							
Industrial Standard	JIS C - 5101-4 (IEC 60384-4)							

RIPPLE CURRENT MULTIPLIER

Frequency Coefficient

Coefficient	60	120	1k	10k~50k
Rated Voltage				
10~100V	0.90	1.00	1.15	1.25
160~250V	0.80	1.00	1.25	1.47
315~500V	0.80	1.00	1.30	1.47

PART NUMBER SYSTEM (EXAMPLE : 200V 470µF)

1	2 3	4 5 6	7	8 9	10	11 12	13 14
E	VP	477	M	2 D	O	3 0	S W

Type (Terminal Code)
 Case Length (30mm)
 Diameter (25mm)
 Voltage (200V)
 Tolerance (±20%)
 Capacitance (470µF)
 Series
 E-CAP

STANDARD RATINGS

Voltage (Code)		10V (1A)		16V (1C)		25V (1E)		35V (1V)	
Cap. (µF)	Code	Case Size	Ripple Current	Case Size	Ripple Current	Case Size	Ripple Current	Case Size	Ripple Current
2700	278							20 x 25	1.29
3300	338							20 x 30	1.57
3900	398					20 x 25	1.58	22 x 25	1.45
4700	478					20 x 30	1.65	20 x 35	1.78
5600	568			20 x 25	1.68	22 x 30	1.61	22 x 30	1.69
6800	688	20 x 25	1.31	20 x 30	1.80	20 x 35	1.85	20 x 40	2.02
8200	828	20 x 30	1.59	22 x 25	1.75	22 x 35	1.61	22 x 35	2.02
10000	109	20 x 30	1.88	20 x 35	2.08	25 x 25	1.87	25 x 25	1.62
12000	129	22 x 25	1.77	22 x 40	2.31	22 x 40	2.31	22 x 35	2.13
15000	159	20 x 35	2.18	22 x 30	2.10	25 x 30	2.34	25 x 30	2.00
18000	189	22 x 30	2.10	25 x 25	2.05	30 x 25	2.16	25 x 30	2.00
22000	229	25 x 25	1.94	22 x 40	2.68	22 x 45	2.65	22 x 40	2.41
27000	279	20 x 40	2.27	25 x 30	2.30	25 x 35	2.61	25 x 35	2.31
33000	339	22 x 35	2.23	30 x 25	2.30	30 x 30	2.61	25 x 35	2.31
39000	399	25 x 30	2.10	22 x 50	3.20	30 x 30	2.74	30 x 25	2.31
47000	479	22 x 40	2.41	25 x 40	3.16	35 x 30	3.26	22 x 50	2.85
56000	569	25 x 30	2.34	30 x 30	2.98	35 x 40	3.56	25 x 40	2.73
		30 x 25	2.25	25 x 45	3.36	35 x 35	3.84	25 x 40	2.75
		22 x 45	2.58	30 x 30	2.98	30 x 40	3.56	30 x 30	2.75
		25 x 35	2.54	25 x 45	3.36	35 x 40	3.84	22 x 50	2.85
		30 x 30	2.50	30 x 35	3.30	35 x 45	4.04	25 x 50	3.05
		22 x 50	3.17	35 x 30	3.25	35 x 45	4.04	30 x 40	3.05
		25 x 40	3.07	35 x 30	3.25	35 x 45	4.04	30 x 40	3.05
		30 x 30	2.95	25 x 50	3.85	35 x 45	4.04	35 x 30	3.19
		25 x 45	3.39	30 x 40	3.80	35 x 45	4.04	35 x 30	3.19
		30 x 35	3.33	35 x 35	3.93	35 x 45	4.04	35 x 30	3.19
		35 x 30	3.21	35 x 35	3.93	35 x 45	4.04	35 x 30	3.19
		30 x 40	3.70	35 x 35	3.93	35 x 45	4.04	35 x 30	3.19
		35 x 35	3.68	25 x 50	3.85	35 x 45	4.04	35 x 30	3.19
		30 x 45	4.22	30 x 50	4.81	35 x 45	4.04	35 x 30	3.19
		35 x 40	4.16	35 x 40	4.80	35 x 45	4.04	35 x 30	3.19
		35 x 50	5.00	35 x 45	5.53	35 x 45	4.04	35 x 30	3.19

Maximum Allowable Ripple Current (Arms) at 105°C 120Hz

Case Size ϕ D x L (mm)



STANDARD RATINGS

Voltage (Code)		50V (1H)		63V (1J)		80V (1K)		100V (2A)	
Cap. (μF)	Code	Case Size	Ripple Current	Case Size	Ripple Current	Case Size	Ripple Current	Case Size	Ripple Current
560	567							20 x 25	0.95
680	687							20 x 30	1.15
								22 x 25	1.09
820	827					20 x 25	1.04	20 x 35	1.31
								22 x 30	1.32
1000	108			20 x 25	1.10	20 x 30	1.24	20 x 35	1.43
								22 x 30	1.47
						22 x 25	1.19	25 x 25	1.45
1200	128			20 x 30	1.20	20 x 35	1.43	20 x 40	1.61
								22 x 35	1.69
				22 x 25	1.20	22 x 30	1.44	25 x 30	1.68
1500	158	20 x 25	1.15	20 x 35	1.47	20 x 35	1.57	22 x 40	1.97
								25 x 35	1.98
				22 x 30	1.47	25 x 25	1.59	30 x 25	1.95
1800	188	20 x 30	1.39	20 x 35	1.58	20 x 40	1.77	22 x 45	2.23
				22 x 30	1.58	22 x 35	1.79	25 x 40	2.20
		22 x 25	1.34	25 x 25	1.52	25 x 30	1.71	30 x 30	2.20
2200	228	20 x 35	1.60	20 x 40	1.80	22 x 40	2.03	25 x 45	2.53
				22 x 35	1.82	25 x 35	1.98	30 x 35	2.55
		22 x 30	1.60	25 x 30	1.75	30 x 25	1.98	35 x 30	2.50
2700	278	20 x 35	1.73	22 x 40	2.07	22 x 45	2.39	25 x 50	2.82
		22 x 30	1.70	25 x 35	2.11	25 x 40	2.35	30 x 40	2.86
		25 x 25	1.70	30 x 25	1.72	30 x 30	2.35	35 x 35	2.89
3300	338	20 x 40	1.97	22 x 45	2.33	25 x 45	2.64	30 x 45	3.30
		22 x 35	1.97	25 x 35	2.27	30 x 35	2.61		
		25 x 30	1.88	30 x 30	2.24	35 x 30	2.47	35 x 35	3.25
3900	398	22 x 40	2.22	25 x 40	2.51	25 x 50	2.92	30 x 50	3.60
		25 x 30	2.20			30 x 40	2.82		
		30 x 25	1.95	30 x 35	2.55	35 x 30	2.97	35 x 40	3.67
4700	478	22 x 45	2.43	25 x 50	2.91	30 x 45	3.34		
		25 x 35	2.43	30 x 40	2.86			35 x 45	3.80
		30 x 30	2.25	35 x 30	2.80	35 x 35	3.38		
5600	568	22 x 50	2.75	30 x 40	3.22	30 x 50	3.80		
		25 x 40	2.72					35 x 50	4.05
		30 x 30	2.64	35 x 35	3.20	35 x 40	3.80		
6800	688	25 x 45	3.30	30 x 50	3.65				
		30 x 35	3.30			35 x 45	3.90		
		35 x 30	3.25	35 x 40	3.65				
8200	828	30 x 40	3.60						
		35 x 35	3.60	35 x 45	4.04	35 x 50	4.20		
10000	109	30 x 50	4.05						
		35 x 40	4.04	35 x 50	4.48				
12000	129	35 x 45	4.56						
15000	159	35 x 50	4.77						

Maximum Allowable Ripple Current (Arms) at 105°C 120Hz

Case Size φD x L (mm)

Specifications are subject to change without notice. Should a safety or technical concern arise regarding the product, please be sure to contact our sales offices or agents immediately.

VP

Large Can Aluminum Electrolytic Capacitors

STANDARD RATINGS

Voltage (Code)		160V (2C)		180V (2P)		220V (2D)		220V (2N)	
Cap. (µF)	Code	Case Size	Ripple Current	Case Size	Ripple Current	Case Size	Ripple Current	Case Size	Ripple Current
180	187							20 x 25	0.81
220	227			20 x 25	0.81	20 x 25	0.83	20 x 30 22 x 25	0.94 0.94
270	277	20 x 25	0.87	20 x 30 22 x 25	0.95 0.97	20 x 30 22 x 25	0.97 0.99	20 x 35 22 x 30	1.10 1.09
330	337	20 x 30 22 x 25	1.02 1.03	20 x 35 22 x 30	1.09 1.13	20 x 35 22 x 30 25 x 25	1.17 1.20 1.20	20 x 40 22 x 35 25 x 25	1.18 1.24 1.14
390	397	20 x 35 22 x 30	1.15 1.17	20 x 35 22 x 30 25 x 25	1.28 1.32 1.33	20 x 40 22 x 35 25 x 25	1.27 1.30 1.34	20 x 45 22 x 35 25 x 30	1.33 1.30 1.26
470	477	20 x 40 22 x 30 25 x 25	1.25 1.28 1.29	20 x 40 22 x 35 25 x 30	1.34 1.39 1.43	22 x 40 25 x 30 30 x 25	1.44 1.44 1.48	22 x 40 25 x 30 30 x 25	1.41 1.39 1.37
560	567	22 x 35 25 x 30	1.45 1.49	22 x 40 25 x 30 30 x 25	1.56 1.53 1.56	22 x 45 25 x 35 30 x 30	1.60 1.60 1.60	22 x 45 25 x 35 30 x 30 35 x 25	1.60 1.56 1.61 1.52
680	687	22 x 40 25 x 35 30 x 25	1.64 1.70 1.63	22 x 45 25 x 35 30 x 30	1.76 1.76 1.74	22 x 50 25 x 40 30 x 30	1.75 1.76 1.74	25 x 40 30 x 35 35 x 30	1.75 1.76 1.72
820	827	22 x 45 25 x 40 30 x 30	1.85 1.92 1.91	22 x 50 25 x 40 30 x 30	1.97 1.99 1.93	25 x 45 30 x 35 35 x 30	2.10 2.11 2.10	25 x 45 30 x 40 35 x 30	1.97 2.06 1.95
1000	108	25 x 45 30 x 35	2.17 2.19	25 x 45 30 x 35 35 x 30	2.24 2.24 2.20	25 x 50 30 x 40 35 x 35	2.36 2.40 2.30	30 x 45 35 x 35	2.44 2.20
1200	128	25 x 50 30 x 40 35 x 30	2.43 2.48 2.25	30 x 40 35 x 35	2.53 2.54	30 x 45 35 x 35	2.69 2.53	35 x 40	2.37
1500	158	30 x 45 35 x 35	2.82 2.62	30 x 50 35 x 40	3.03 2.91	35 x 40	2.97	35 x 45	2.64
1800	188	30 x 50 35 x 40	3.13 2.97	35 x 45	3.25	35 x 50	3.45		
2200	228	35 x 45	3.34	35 x 50	3.62				

Maximum Allowable Ripple Current (Arms) at 105°C 120Hz

Case Size Φ D x L (mm)

Specifications are subject to change without notice. Should a safety or technical concern arise regarding the product, please be sure to contact our sales offices or agents immediately.



STANDARD RATINGS

Voltage (Code)		250V (2E)		315V (2F)		350V (2V)		385V (2Y)	
Cap. (μF)	Code	Case Size	Ripple Current	Case Size	Ripple Current	Case Size	Ripple Current	Case Size	Ripple Current
56	566							20 x 25	0.37
68	686					20 x 25	0.41	20 x 30 22 x 25	0.44 0.45
82	826			20 x 25	0.39	20 x 30	0.45	20 x 30 22 x 30	0.50 0.52
100	107			20 x 30	0.45	20 x 30 22 x 25	0.51 0.53	20 x 35 22 x 30 25 x 25	0.56 0.58 0.57
120	127			20 x 30 22 x 25	0.54 0.56	20 x 35 22 x 30 25 x 25	0.59 0.61 0.62	20 x 40 22 x 35 25 x 30	0.68 0.68 0.68
150	157	20 x 25	0.71	20 x 35 22 x 30 25 x 25	0.64 0.66 0.65	20 x 40 22 x 35 25 x 30	0.70 0.73 0.73	22 x 40 25 x 30 30 x 25	0.79 0.78 0.75
180	187	20 x 30 22 x 25	0.82 0.84	20 x 40 22 x 35 25 x 30	0.75 0.78 0.71	22 x 40 25 x 30 30 x 25	0.83 0.80 0.81	22 x 45 25 x 35 30 x 30	0.89 0.86 0.88
220	227	20 x 35 22 x 30 25 x 25	0.95 0.97 0.99	22 x 40 25 x 30 30 x 25	0.89 0.85 0.83	22 x 45 25 x 35 30 x 30	0.94 0.92 0.98	22 x 50 25 x 40 30 x 30	1.01 1.00 1.00
270	277	20 x 40 22 x 35 25 x 30	1.08 1.11 1.15	22 x 45 25 x 35 30 x 30	1.01 0.98 1.01	22 x 50 25 x 40 30 x 30	1.07 1.05 1.03	25 x 45 30 x 40 35 x 30	1.13 1.14 1.10
330	337	22 x 40 25 x 30 30 x 25	1.26 1.26 1.31	22 x 50 25 x 40 30 x 35	1.14 1.12 1.21	25 x 45 30 x 35 35 x 30	1.24 1.24 1.18	30 x 45 35 x 35	1.31 1.32
390	397	22 x 45 25 x 35 30 x 30	1.41 1.42 1.50	25 x 45 30 x 35 35 x 30	1.31 1.30 1.23	25 x 50 30 x 40 35 x 35	1.38 1.39 1.39	30 x 50 35 x 40	1.48 1.48
470	477	22 x 50 25 x 40 30 x 30	1.58 1.61 1.61	30 x 40 35 x 35	1.53 1.47	30 x 45 35 x 35	1.57 1.50	35 x 45	1.76
560	567	25 x 45 30 x 35	1.80 1.84	30 x 45 35 x 40	1.65 1.66	30 x 50 35 x 40	1.75 1.69	35 x 50	1.95
680	687	25 x 50 30 x 40 35 x 30	2.03 2.09 1.96	35 x 45	1.96	35 x 45	1.96		
820	827	30 x 45 35 x 35	2.35 2.26	35 x 50	2.19				
1000	108	30 x 50 35 x 40	2.64 2.57						
1200	128	35 x 45	2.88						

Maximum Allowable Ripple Current (Arms) at 105°C 120Hz

Case Size φD x L (mm)

VP
Large Can Aluminum Electrolytic Capacitors

Specifications are subject to change without notice. Should a safety or technical concern arise regarding the product, please be sure to contact our sales offices or agents immediately.

STANDARD RATINGS

Voltage (Code)		400V (2G)		420V (2M)		450V (2W)		500V (2H)	
Cap. (µF)	Code	Case Size	Ripple Current	Case Size	Ripple Current	Case Size	Ripple Current	Case Size	Ripple Current
39	396							22 x 30	0.35
47	476					20 x 25	0.36	22 x 35	0.41
56	566	20 x 25	0.40	20 x 25	0.40	20 x 30	0.41	22 x 40	0.47
						22 x 25	0.42		
68	686	20 x 30	0.48	20 x 30	0.48	20 x 35	0.47	22 x 45	0.54
		22 x 25	0.49	22 x 25	0.50	22 x 30	0.50		
82	826	20 x 30	0.54	20 x 35	0.53	20 x 40	0.53	25 x 40	0.62
		22 x 30	0.56	22 x 30	0.56	22 x 35	0.56		
100	107	20 x 35	0.60	20 x 35	0.58	22 x 40	0.64	25 x 45	0.67
		22 x 30	0.62	22 x 30	0.63	25 x 30	0.63		
		25 x 25	0.61	25 x 25	0.63	30 x 25	0.67		
120	127	20 x 40	0.71	20 x 45	0.71	22 x 45	0.72	25 x 50	0.77
		22 x 35	0.73	22 x 35	0.73	25 x 35	0.71	35 x 30	0.72
		25 x 30	0.73	25 x 30	0.72	30 x 30	0.77		
150	157	22 x 40	0.85	22 x 45	0.86	22 x 50	0.80	30 x 40	0.82
		25 x 35	0.85	25 x 35	0.83	25 x 40	0.82		
		30 x 25	0.79	30 x 25	0.83	30 x 30	0.85		
180	187	22 x 45	0.95	22 x 50	1.02	25 x 45	0.93	30 x 50	1.01
		25 x 35	0.92	25 x 40	0.94	30 x 35	0.97		
		30 x 30	0.95	30 x 30	0.95				
220	227	22 x 50	1.08	25 x 45	1.13	25 x 50	1.05	35 x 45	1.12
		25 x 40	1.05	30 x 35	1.09	30 x 40	1.10		
		30 x 35	1.24	35 x 30	1.05	35 x 30	1.01		
270	277	25 x 50	1.29	25 x 50	1.37	30 x 45	1.25	35 x 50	1.29
		30 x 40	1.30	30 x 40	1.25	35 x 35	1.26		
		35 x 30	1.18	35 x 35	1.25				
330	337	30 x 45	1.47	30 x 45	1.49	30 x 50	1.42		
		35 x 35	1.41	35 x 35	1.42	35 x 40	1.44		
390	397	30 x 50	1.64	30 x 50	1.67	35 x 45	1.61		
		35 x 40	1.59	35 x 40	1.61				
470	477	35 x 45	1.87	35 x 45	1.86	35 x 50	1.80		
560	567	35 x 50	2.09						

Maximum Allowable Ripple Current (Arms) at 105°C 120Hz

Case Size ϕ D x L (mm)

Specifications are subject to change without notice. Should a safety or technical concern arise regarding the product, please be sure to contact our sales offices or agents immediately.

FEATURES

- One rank smaller case sized than HP series.
- Suited for equipment down sizing.



SPECIFICATIONS

Item	Performance Characteristics	
Operating Temperature Range	-40 to +105°C	-25 to +105°C
Rated Working Voltage Range	160 to 250V	400 to 450V
Nominal Capacitance Range	100 to 3300µF	
Capacitance Tolerance	±20% at 120Hz, +20°C	
Leakage Current	I ≤ 3√CV (µA) after 5 minutes application of rated working voltage at +20°C	
tan δ (120Hz, +20°C)	Working Voltage (V)	160 180 200 220 250 400 420 450
	tan δ (max.)	0.15 0.15 0.15 0.15 0.15 0.15 0.15 0.20
Low Temperature Characteristics	Impedance ratio max. at 120Hz	
	Working Voltage (V)	160~250 400~450
	Z-25°C / Z+20°C	4 8
	Z-40°C / Z+20°C	15 -
High Temperature Loading	Test time : 2,000 hours	Post test requirements at +20°C
	Test temperature : +105°C	Leakage current : ≤Initial specified value
	Test conditions : Rated DC working voltage with rated ripple current	Cap. change : within ±20% of the initial measured value
		tan δ : ≤200% of the initial specified value
Shelf Life	At +105°C no voltage applied after 1,000 hours and then being stabilized at +20°C the capacitors shall meet the following limits	
	Leakage current : ≤Initial specified value	
	Cap. change : within ±15% of the initial measured value	
	tan δ : ≤150% of the initial specified value	
Industrial Standard	JIS C - 5101-4 (IEC 60384-4)	

RIPPLE CURRENT MULTIPLIER

Frequency Coefficient

Coefficient	Freq. (Hz)			
Rated Voltage	60	120	1k	10k~50k
160~250V	0.85	1.00	1.32	1.45
400~450V	0.82	1.00	1.30	1.41

PART NUMBER SYSTEM (EXAMPLE : 250V 560µF)

1	2 3	4 5 6	7	8 9	10	11 12	13 14
E	GP	567	M	2 E	O	3 5	S W

Type (Terminal Code)
 Case Length (35mm)
 Diameter (25mm)
 Voltage (250V)
 Tolerance (±20%)
 Capacitance (560µF)
 Series
 E-CAP

STANDARD RATINGS

Voltage (Code)		160V (2C)		180V (2P)		200V (2D)		220V (2N)	
Cap. (µF)	Code	Case Size	Ripple Current	Case Size	Ripple Current	Case Size	Ripple Current	Case Size	Ripple Current
330	337							22 x 25	1.26
390	397							22 x 30	1.34
470	477			22 x 25	1.30	22 x 25	1.20	22 x 35	1.48
								25 x 25	1.40
560	567	22 x 25	1.40	22 x 30	1.50	22 x 30	1.48	22 x 35	1.45
						25 x 25	1.48	25 x 30	1.45
680	687	22 x 30	1.50	22 x 35	1.70	22 x 35	1.60	22 x 40	1.65
		25 x 25	1.70	25 x 30	1.70	25 x 30	1.60	25 x 35	1.78
820	827			22 x 40	2.00	22 x 40	1.75	30 x 25	1.65
				25 x 35	2.00	25 x 35	1.75	22 x 50	1.93
		25 x 30	2.00	30 x 25	2.00	30 x 25	1.75	25 x 40	1.93
1000	108	22 x 40	2.10	22 x 45	2.10	22 x 45	2.04	30 x 30	1.85
		25 x 35	2.20	25 x 35	2.05	25 x 40	2.04	35 x 25	1.93
		30 x 25	2.20	30 x 30	2.20	30 x 30	2.04	30 x 45	2.15
1200	128	25 x 40	2.30	22 x 50	2.15	25 x 45	2.30	30 x 35	2.33
				25 x 40	2.15	30 x 35	2.30	35 x 30	2.50
		30 x 30	2.30	30 x 35	2.30	35 x 25	2.30	30 x 40	2.50
1500	158	35 x 25	2.30	35 x 25	2.15	35 x 25	2.30	35 x 35	2.35
		25 x 45	2.50	25 x 50	2.40	25 x 50	2.57	30 x 45	2.55
		30 x 35	2.50	30 x 40	2.50	30 x 40	2.57	35 x 35	2.50
1800	188	35 x 30	2.50	35 x 30	2.35	35 x 30	2.57		
		30 x 40	2.70	30 x 45	2.70	30 x 45	2.68	35 x 40	2.70
		35 x 30	2.55	35 x 35	2.70	35 x 35	2.68		
2200	228	30 x 45	2.90	30 x 50	2.90	30 x 50	2.92	35 x 50	2.95
		35 x 35	2.90	35 x 40	2.90	35 x 40	2.92		
2700	278	35 x 40	3.00	35 x 45	3.00	35 x 45	3.27		
3300	338	35 x 45	3.10	35 x 50	3.10				

Maximum Allowable Ripple Current (Arms) at 105°C 120Hz

Case Size Φ D x L (mm)

STANDARD RATINGS

Voltage (Code)		250V (2E)		400V (2G)		420V (2M)		450V (2W)	
Cap. (μF)	Code	Case Size	Ripple Current	Case Size	Ripple Current	Case Size	Ripple Current	Case Size	Ripple Current
100	107							22 x 25	0.64
120	127			22 x 25	0.68	22 x 30	0.81	22 x 30 25 x 25	0.69 0.69
150	157					22 x 35 25 x 25	0.84 0.82	22 x 35 25 x 30	0.72 0.79
180	187			22 x 30 25 x 25	0.73 0.73	22 x 35 25 x 30	0.85 0.91	22 x 40 25 x 30	0.79 0.79
220	227			22 x 35 25 x 30	0.85 0.85	22 x 40 25 x 35 30 x 25	0.95 1.05 0.95	22 x 45 25 x 35 30 x 30	0.87 0.87 0.79
270	277			22 x 40 25 x 35 30 x 25	1.00 1.00 1.00	22 x 50 25 x 40 30 x 30	1.15 1.25 1.25	25 x 50 30 x 35 35 x 35	1.20 1.20 1.20
330	337			22 x 50 25 x 40 30 x 30 35 x 25	1.15 1.15 1.15 1.15	25 x 45 30 x 35 35 x 30	1.35 1.42 1.42	25 x 50 30 x 35 35 x 30	1.20 1.20 1.20
390	397	22 x 30 25 x 25	1.20 1.20	25 x 45 30 x 35 35 x 30	1.40 1.40 1.55	25 x 50 30 x 40 35 x 30	1.45 1.61 1.45	30 x 40 35 x 35	1.38 1.38
470	477	22 x 35 25 x 30	1.30 1.30	25 x 50 30 x 40 35 x 30	1.55 1.55 1.55	30 x 45 35 x 35	1.86 1.70	30 x 45 35 x 40	1.55 1.55
560	567	22 x 40 25 x 35 30 x 25	1.40 1.50 1.40	30 x 45 35 x 35	1.63 1.63	35 x 40	1.90	35 x 45	1.70
680	687	22 x 45 25 x 40 30 x 30	1.50 1.70 1.70	30 x 50 35 x 40	1.80 1.80	35 x 45	2.05	35 x 50	1.91
820	827	25 x 45 30 x 35 35 x 30	2.00 2.00 2.00	35 x 45	2.00				
1000	108	25 x 50 30 x 40 35 x 30	2.20 2.20 2.00	35 x 50	2.14				
1200	128	30 x 45 35 x 35	2.30 2.20						
1500	158	30 x 50 35 x 40	2.30 2.30						
1800	188	35 x 45	2.50						

Maximum Allowable Ripple Current (Arms) at 105°C 120Hz

Case Size φD x L (mm)

CASE SIZE TABLE

O-Type



Unit : mm

D-Type



Unit : mm



FEATURES

- Small case size, high rated voltage, capacitance and ripple current, stable and reliable performance, forming complete sets of unclear electric station.
- Suitable for use in electronic and industrial equipments such as computer, programming control exchanger for power supplies filtering and energy storing.

SPECIFICATIONS

Item	Performance Characteristics	
Operating Temperature Range	-40 to +85°C	-25 to +85°C
Rated Working Voltage Range	10 to 100V	160 to 630V
Nominal Capacitance Range	100 to 680000μF	
Capacitance Tolerance	±20% at 120Hz, +20°C	
Leakage Current	I ≤ 0.02CV (μA) or 5 (mA) whichever is smaller measured after 5 minutes application of rated working voltage at +20°C	
tan δ (120Hz, +20°C)	The values shown in the STANDARD RATINGS tables	
Low Temperature Characteristics	Impedance ratio max. at 120Hz	
	Working Voltage (V)	10~100 160~630
	Z-25°C / Z+20°C	— 8
	Z-40°C / Z+20°C	15 —
High Temperature Loading	Test time : 2,000 hours	Post test requirements at +20°C
	Test temperature : +85°C	Leakage current : ≤ Initial specified value
	Test conditions : Rated DC working voltage with rated ripple current	Cap. change : within ±20% of the initial measured value
		tan δ : ≤ 200% of the initial specified value
Shelf Life	At +85°C no voltage applied after 1,000 hours and then being stabilized at +20°C the capacitors shall meet the following limits	
	Leakage current : ≤ Initial specified value	
	Cap. change : within ±20% of the initial measured value	
	tan δ : ≤ 175% of the initial specified value	
Industrial Standard	JIS C - 5101-4 (IEC 60384-4)	

RIPPLE CURRENT MULTIPLIER

Frequency Coefficient

Coefficient	Freq. (Hz)				
	50	120	300	1k	10k~
Rated Voltage					
<160V	0.80	1.00	1.08	1.15	1.15
≥160V	0.80	1.00	1.08	1.15	1.20

PART NUMBER SYSTEM (EXAMPLE : 160V 6800μF)

1	2 3	4 5 6	7	8 9	10	11 12	13 14
E	WR	688	M	2C	S	1L	OO

Type (Terminal Code)
 Case Length (100mm)
 Diameter (51mm)
 Voltage (160V)
 Tolerance (±20%)
 Capacitance (6800μF)
 Series
 E-CAP

CASE SIZE TABLE



Dimensions of mounting bracket

Voltage (Code)		3 - Leg				2 - Leg				
Symbol	ϕD	51	63.5	76	90	35	51	63.5	76	90
P		32.5	38.1	44.5	50.8	24	33.2	40.5	46.5	53
A		38.5	43	49.2	58.5	29	40	46.5	53	59
T		7.5	8.0	7.0	8.0	6.0	6.0	7.0	6.0	6.0
S		5.0	5.0	5.0	5.0	3.5	4.5	4.5	4.5	4.5
U		12	14	14	18	10	14	14	14	14
θ°		60	60	60	60	30	30	30	30	30
H		20	25	30	35	15	25	35	35	35
h		15	20	24	25	10	15	20	20	20

STANDARD RATINGS

Voltage (Code)		10V (1A)			16V (1C)			25V (1E)		
SV		13			20			32		
Cap. (μF)	Code	Case Size	tan δ	Ripple Current	Case Size	tan δ	Ripple Current	Case Size	tan δ	Ripple Current
18000	189							35 x 50	0.35	4.0
27000	279				35 x 50	0.45	4.2			
39000	399	35 x 50	0.60	4.7				35 x 80	0.40	6.2
47000	479							35 x 100	0.40	7.4
56000	569				35 x 80	0.60	6.5	35 x 120	0.45	8.3
82000	829	35 x 80	0.60	7.0	35 x 100	0.70	8.0	51 x 80	0.50	9.7
100000	10T	35 x 100	0.70	8.0	35 x 120	0.70	9.6	51 x 100	0.60	10.8
120000	12T	35 x 120	0.70	9.4	51 x 80	0.80	9.6	51 x 120	0.60	12.0
150000	15T	51 x 80	0.90	9.8	51 x 100	0.90	11.2			
180000	18T							63.5 x 100	0.75	14.7
220000	22T	51 x 100	1.00	10.3	51 x 120	1.00	14.2	63.5 x 100	0.80	15.0
270000	27T	51 x 120	1.20	12.8	63.5 x 100	1.20	15.3	76 x 100	0.90	18.3
330000	33T				63.5 x 120	1.30	17.1	76 x 120	1.00	20.7
390000	39T	63.5 x 100	1.50	15.3	76 x 100	1.60	18.0	76 x 140	1.20	22.1
470000	47T	63.5 x 120	2.00	16.0	76 x 100	1.80	19.3			
560000	56T	76 x 120	2.50	17.3	76 x 140	2.00	20.7	90 x 140	1.50	25.8
680000	68T	76 x 120	3.00	18.7						

Maximum Allowable Ripple Current (Arms) at 85°C 120Hz
tan δ at 20°C 120Hz

Case Size ΦD x L (mm)

Voltage (Code)		35V (1V)			50V (1H)			63V (1J)		
SV		44			63			79		
Cap. (μF)	Code	Case Size	tan δ	Ripple Current	Case Size	tan δ	Ripple Current	Case Size	tan δ	Ripple Current
5600	568							35 x 50	0.20	3.0
10000	109				35 x 50	0.25	3.9	35 x 80	0.25	4.0
15000	159	35 x 50	0.30	3.9				35 x 100	0.25	5.3
18000	189				35 x 80	0.25	5.2	35 x 120	0.25	6.2
22000	229				35 x 100	0.30	5.7	51 x 80	0.30	6.5
27000	279				35 x 120	0.35	6.6			
33000	339	35 x 80	0.40	6.0				51 x 100	0.35	8.1
39000	399	35 x 100	0.40	6.7	51 x 80	0.40	7.4	51 x 120	0.35	9.5
47000	479	35 x 120	0.45	8.0				63.5 x 100	0.40	10.2
56000	569				51 x 100	0.40	9.8			
68000	689	51 x 80	0.50	8.5	51 x 120	0.45	11.1	63.5 x 120	0.45	12.7
82000	829	51 x 100	0.55	10.3	63.5 x 100	0.50	12.2			
100000	10T	51 x 120	0.60	11.3				76 x 120	0.45	16.7
120000	12T	51 x 120	0.60	12.8	63.5 x 120	0.50	15.0	76 x 140	0.50	19.0
150000	15T	63.5 x 100	0.70	13.2	76 x 115	0.60	17.7	90 x 140	0.55	22.0
180000	18T	63.5 x 120	0.70	15.3	76 x 140	0.70	19.5			
220000	22T	76 x 100	0.75	17.8						
270000	27T	76 x 120	0.80	18.4	90 x 140	0.80	23.2			
330000	33T	76 x 140	0.90	22.0						
470000	47T	90 x 140	1.00	28.0						

Maximum Allowable Ripple Current (Arms) at 85°C 120Hz
tan δ at 20°C 120Hz

Case Size ΦD x L (mm)

Specifications are subject to change without notice. Should a safety or technical concern arise regarding the product, please be sure to contact our sales offices or agents immediately.

STANDARD RATINGS

Voltage (Code)		80V (1K)			100V (2A)			160V (2C)		
SV		100			125			200		
Cap. (µF)	Code	Case Size	tan δ	Ripple Current	Case Size	tan δ	Ripple Current	Case Size	tan δ	Ripple Current
1200	128							35 x 50	0.15	2.0
2200	228				35 x 50	0.10	2.1	35 x 80	0.15	3.4
2700	278							35 x 100	0.15	3.7
3300	338	35 x 50	0.15	2.5				35 x 120	0.15	4.5
4700	478				35 x 80	0.15	3.4	51 x 80	0.20	5.6
6800	688	35 x 80	0.20	3.7	35 x 100	0.15	4.2	51 x 100	0.20	7.5
8200	828				35 x 120	0.15	5.0	51 x 120	0.20	8.1
10000	109	35 x 100	0.20	4.9	51 x 80	0.20	5.2	63.5 x 100	0.20	9.8
12000	129	35 x 120	0.20	5.4				63.5 x 120	0.20	10.8
15000	159	51 x 80	0.25	6.0				76 x 100	0.20	12.7
18000	189				51 x 120	0.20	8.1	76 x 120	0.20	14.0
22000	229	51 x 100	0.30	7.1	63.5 x 100	0.25	8.6	76 x 130	0.20	16.6
27000	279	51 x 120	0.30	8.6	63.5 x 120	0.25	10.3	76 x 140	0.20	16.6
33000	339	63.5 x 100	0.35	9.3	76 x 100	0.25	11.1	90 x 140	0.25	18.9
39000	399				76 x 120	0.25	12.4			
47000	479	63.5 x 120	0.35	12.0	76 x 140	0.25	14.3			
68000	689	76 x 120	0.35	15.4	90 x 140	0.30	18.0			
82000	829	76 x 140	0.35	18.1						
100000	10T	90 x 140	0.40	21.0						

Maximum Allowable Ripple Current (Arms) at 85°C 120Hz
tan δ at 20°C 120Hz

Case Size ΦD x L (mm)

Voltage (Code)		200V (2D)			250V (2E)			350V (2V)		
SV		250			300			400		
Cap. (µF)	Code	Case Size	tan δ	Ripple Current	Case Size	tan δ	Ripple Current	Case Size	tan δ	Ripple Current
390	397							35 x 50	0.25	1.9
560	567				35 x 50	0.15	1.3			
680	687							35 x 80	0.25	2.9
820	827	35 x 50	0.15	1.6						
1000	108							35 x 100	0.25	3.8
1200	128				35 x 80	0.15	2.3	35 x 120	0.25	4.2
1500	158				35 x 100	0.15	3.0	51 x 80	0.25	4.5
1800	188	35 x 80	0.15	2.8	35 x 120	0.15	3.3			
2200	228	35 x 100	0.15	3.6	51 x 80	0.15	3.7	51 x 90	0.25	5.8
2700	278	35 x 120	0.15	4.0						
3300	338	51 x 80	0.15	4.5	51 x 100	0.15	5.1	51 x 130	0.25	8.3
3900	398				51 x 120	0.15	5.9	63.5 x 110	0.25	9.2
4700	478	51 x 100	0.15	6.5	63.5 x 95	0.20	6.7	63.5 x 130	0.25	10.9
5600	568	51 x 120	0.15	7.6	63.5 x 100	0.20	6.9	76 x 90	0.25	10.3
6800	688							76 x 115	0.25	11.7
8200	828	63.5 x 100	0.20	9.5	63.5 x 120	0.20	8.7	76 x 130	0.25	14.0
10000	109	63.5 x 120	0.20	11.0	76 x 120	0.20	11.1	76 x 155	0.25	15.6
12000	129	76 x 100	0.20	11.5	76 x 150	0.20	12.2			
15000	159	76 x 120	0.20	12.8	76 x 140	0.20	13.0	90 x 150	0.25	20.0
18000	189	76 x 140	0.20	15.0	76 x 155	0.25	16.1			
22000	229	90 x 140	0.25	15.6	90 x 140	0.20	14.9			
					90 x 150	0.20	18.5			
					90 x 155	0.20	19.0			

Maximum Allowable Ripple Current (Arms) at 85°C 120Hz
tan δ at 20°C 120Hz

Case Size ΦD x L (mm)

Specifications are subject to change without notice. Should a safety or technical concern arise regarding the product, please be sure to contact our sales offices or agents immediately.

STANDARD RATINGS

Voltage (Code)		400V (2G)			450V (2W)			500V (2H)		
SV		450			500			550		
Cap. (μF)	Code	Case Size	tan δ	Ripple Current	Case Size	tan δ	Ripple Current	Case Size	tan δ	Ripple Current
470	477							51 x 80	0.25	1.8
680	687							51 x 105	0.25	2.5
820	827							51 x 105	0.25	2.8
1000	108	51 x 80	0.25	3.4	51 x 80	0.25	3.5	51 x 115	0.25	3.2
1200	128	51 x 80	0.25	3.8	51 x 100	0.25	4.5			
1500	158	51 x 105	0.25	4.5	51 x 105	0.25	5.0	51 x 115	0.25	4.0
1800	188	51 x 105	0.25	5.2	51 x 115	0.25	5.6	63.5 x 95	0.25	4.0
		63.5 x 95	0.25	6.4	51 x 130	0.25	6.5	63.5 x 115	0.25	4.8
2200	228	51 x 100	0.25	5.6				63.5 x 130	0.25	5.7
		51 x 140	0.25	6.5	63.5 x 95	0.25	6.5			
2700	278	51 x 130	0.25	7.1	63.5 x 115	0.25	7.8	76 x 115	0.25	6.5
3300	338	63.5 x 115	0.25	8.5	63.5 x 130	0.25	9.1			
					76 x 115	0.25	9.0			
3900	398	63.5 x 130	0.25	9.7	63.5 x 160	0.25	9.5	76 x 130	0.25	8.4
					76 x 115	0.25	9.7			
4700	478	63.5 x 160	0.25	10.5	76 x 130	0.25	11.2			
		76 x 105	0.25	10.3						
		76 x 115	0.25	10.7	90 x 120	0.25	11.5			
5600	568	63.5 x 190	0.25	12.0						
		76 x 115	0.25	11.5	76 x 155	0.25	13.3			
		76 x 130	0.25	12.2						
6800	688	76 x 150	0.25	14.4	76 x 155	0.25	14.4			
		76 x 155	0.25	14.6	76 x 170	0.25	15.0			
					90 x 155	0.25	15.3			
8200	828	76 x 155	0.25	14.6						
		76 x 170	0.25	15.0	90 x 155	0.25	17.0			
		90 x 150	0.25	16.5						
		90 x 155	0.25	16.8						
10000	109	76 x 170	0.25	17.5						
		90 x 130	0.25	17.1						
		90 x 150	0.25	18.2	90 x 170	0.25	18.5			
		90 x 155	0.25	18.5						
		90 x 160	0.25	18.7						
12000	129	90 x 170	0.25	20.5	90 x 230	0.25	23.5			
15000	159	90 x 230	0.25	26.5						

Maximum Allowable Ripple Current (Arms) at 85°C 120Hz
tan δ at 20°C 120Hz

Case Size ΦD x L (mm)

Voltage (Code)		550V (25)			600V (26)			630V (2J)		
SV		600			650			680		
Cap. (μF)	Code	Case Size	tan δ	Ripple Current	Case Size	tan δ	Ripple Current	Case Size	tan δ	Ripple Current
100	107	35 x 50	0.25	0.6						
180	187	35 x 80	0.25	1.0						
270	277	35 x 100	0.25	1.3						
330	337	35 x 120	0.25	1.6						
390	397	51 x 80	0.25	1.7						
560	567	51 x 100	0.25	2.1						
		63.5 x 120	0.25	2.5						
680	687	51 x 130	0.25	2.7						
		63.5 x 130	0.25	3.0						
820	827	51 x 130	0.25	3.1						
		63.5 x 100	0.25	3.5						
1000	108				63.5 x 120	0.30	5.3	63.5 x 130	0.30	5.9
1200	128	76 x 100	0.25	4.2	76 x 100	0.30	6.0	76 x 110	0.30	6.7
1500	158	76 x 100	0.25	4.6	76 x 120	0.30	7.3	76 x 130	0.30	8.1
1800	188	76 x 100	0.25	5.2	76 x 140	0.30	8.6	76 x 150	0.30	9.6
2200	228	76 x 110	0.25	5.9	90 x 120	0.30	9.6	90 x 130	0.30	10.7
2700	278				90 x 140	0.30	11.3	90 x 150	0.30	12.6
3300	338	76 x 140	0.25	8.0	90 x 160	0.30	13.2	90 x 170	0.30	14.7
3900	398				90 x 180	0.30	15.6	90 x 190	0.30	17.3

Maximum Allowable Ripple Current (Arms) at 85°C 120Hz
tan δ at 20°C 120Hz

Case Size ΦD x L (mm)

Specifications are subject to change without notice. Should a safety or technical concern arise regarding the product, please be sure to contact our sales offices or agents immediately.

FEATURES

- Load life of 2,000 hours application of ripple current at 85°C.
- Higher ripple current than WR series, high reliability type.
- Inverter-use.



SPECIFICATIONS

Item	Performance Characteristics			
Operating Temperature Range	-25 to +85°C			
Rated Working Voltage Range	350 to 450V			
Nominal Capacitance Range	390 to 22000μF			
Capacitance Tolerance	±20% at 120Hz, +20°C			
Leakage Current	I ≤ 0.02CV (μA) or 5 (mA) whichever is smaller measured after 5 minutes application of rated working voltage at +20°C			
tan δ (120Hz, +20°C)	0.25			
Low Temperature Characteristics	Impedance ratio max. at 120Hz			
	<table border="1"> <tr> <td>Working Voltage (V)</td> <td>350~450</td> </tr> <tr> <td>Z-25°C / Z+20°C</td> <td>8</td> </tr> </table>	Working Voltage (V)	350~450	Z-25°C / Z+20°C
Working Voltage (V)	350~450			
Z-25°C / Z+20°C	8			
High Temperature Loading	Test time : 2,000 hours Test temperature : +85°C Test conditions : Rated DC working voltage with rated ripple current			
	Post test requirements at +20°C Leakage current : ≤ Initial specified value Cap. change : within ±20% of the initial measured value tan δ : ≤ 200% of the initial specified value			
Shelf Life	At +85°C no voltage applied after 1,000 hours and then being stabilized at +20°C the capacitors shall meet the following limits Leakage current : ≤ Initial specified value Cap. change : within ±20% of the initial measured value tan δ : ≤ 175% of the initial specified value			
Industrial Standard	JIS C - 5101-4 (IEC 60384-4)			

RIPPLE CURRENT MULTIPLIER

Frequency Coefficient

Coefficient	Freq. (Hz)	Rated Voltage				
		50	120	300	1k	10k~
<160V		0.80	1.00	1.08	1.15	1.15
≥160V		0.80	1.00	1.08	1.15	1.20

PART NUMBER SYSTEM (EXAMPLE : 350V 2200μF)

1	2 3	4 5 6	7	8 9	10	11 12	13 14
E	WI	228	M	2V	S	95	O5

Type (Terminal Code)
 Case Length (95mm)
 Diameter (51mm)
 Voltage (350V)
 Tolerance (±20%)
 Capacitance (2200μF)
 Series
 E-CAP

CASE SIZE TABLE

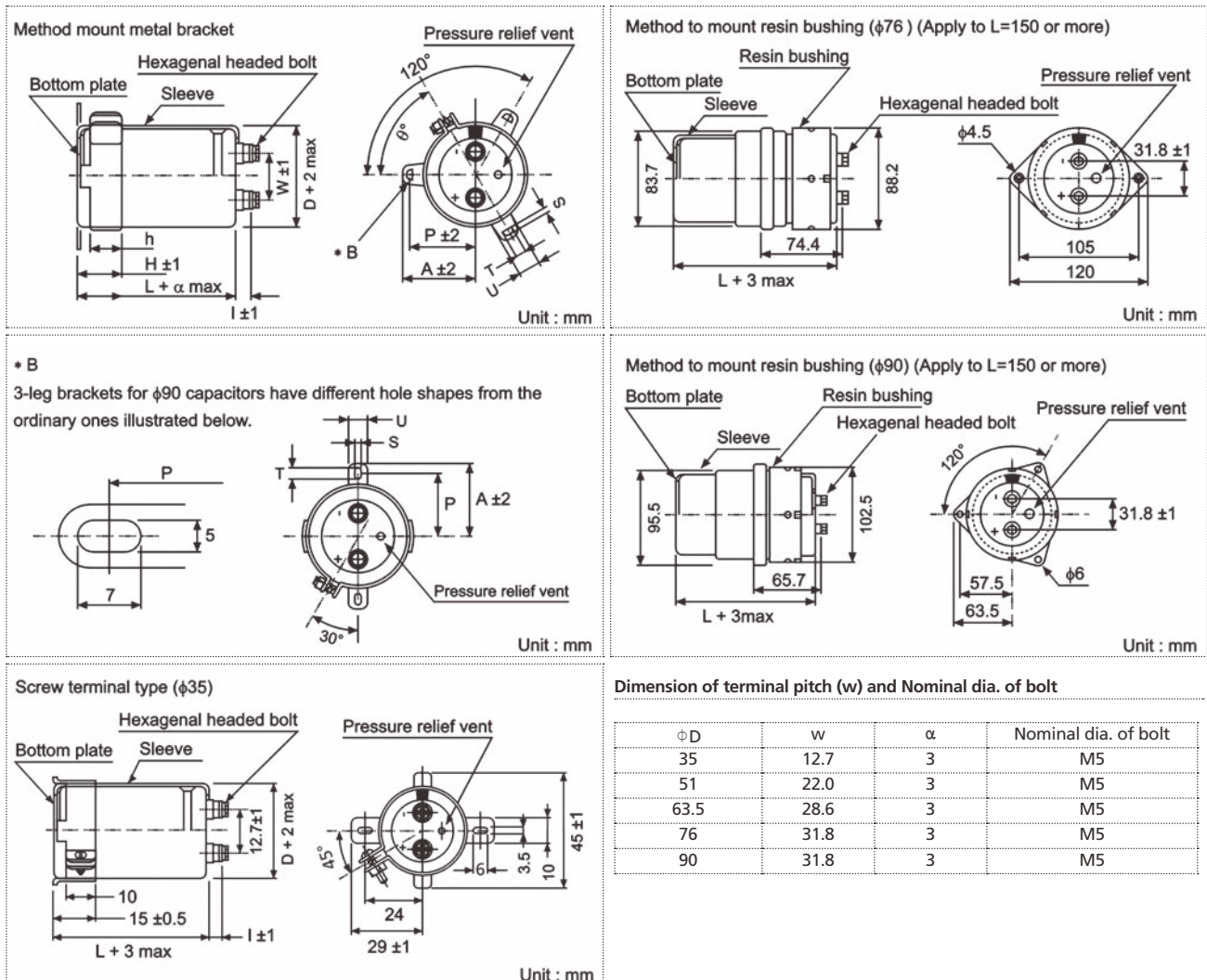

Dimensions of mounting bracket

Voltage (Code)		3-Leg				2-Leg				
Symbol	φD	51	63.5	76	90	35	51	63.5	76	90
P		32.5	38.1	44.5	50.8	24	33.2	40.5	46.5	53
A		38.5	43	49.2	58.5	29	40	46.5	53	59
T		7.5	8.0	7.0	8.0	6.0	6.0	7.0	6.0	6.0
S		5.0	5.0	5.0	5.0	3.5	4.5	4.5	4.5	4.5
U		12	14	14	18	10	14	14	14	14
θ°		60	60	60	60	30	30	30	30	30
H		20	25	30	35	15	25	35	35	35
h		15	20	24	25	10	15	20	20	20

STANDARD RATINGS

Voltage (Code)		350V (2V)		400V (2G)		450V (2W)	
SV		400		450		500	
Cap. (μF)	Code	Case Size	Ripple Current	Case Size	Ripple Current	Case Size	Ripple Current
390	397	35 x 50	1.9				
560	567			35 x 80	2.8		
680	687	35 x 80	3.1				
820	827			35 x 100	3.8		
1000	108	35 x 100	4.2	35 x 120	4.5	51 x 75	5.4
1200	128	35 x 120	4.8	51 x 75	4.9	51 x 95	6.6
1500	158	51 x 75	5.3			51 x 115	7.6
1800	188			51 x 95	6.4	51 x 130	8.3
2200	228	51 x 95	7.1	51 x 130	8.1	63.5 x 95	10.0
2700	278			63.5 x 96	8.9	63.5 x 115	11.7
3300	338	51 x 130	10.0	63.5 x 115	11.3	63.5 x 130	12.0
3900	398	63.5 x 115	11.7	63.5 x 130	12.3	76 x 115	13.3
4700	478	63.5 x 130	13.5	76 x 106	13.8	76 x 130	15.4
				76 x 115	14.3		
5600	568	76 x 115	15.5	76 x 130	16.5	76 x 155	18.2
6800	688	76 x 130	17.9	76 x 144	19.0	90 x 155	20.6
				76 x 155	19.6		
8200	828	76 x 155	20.4	90 x 155	22.0	90 x 155	22.1
10000	109	90 x 130	21.7	90 x 155	23.6	90 x 195	27.2
12000	129	90 x 155	24.7	90 x 195	27.5	90 x 235	32.1
15000	159	90 x 195	28.6	90 x 235	32.1		
18000	189	90 x 235	34.1				
22000	229			90 x 235	38.9		

Maximum Allowable Ripple Current (Arms) at 85°C 120Hz

Case Size Φ D x L (mm)

Specifications are subject to change without notice. Should a safety or technical concern arise regarding the product, please be sure to contact our sales offices or agents immediately.

FEATURES

- Load life of 2,000 hours application of ripple current at 105°C.
- Suitable for use in electronic and industrial equipments such as computer, programming control exchanger for power supplies filtering and energy storing.



SPECIFICATIONS

Item	Performance Characteristics	
Operating Temperature Range	-40 to +105°C	-25 to +105°C
Rated Working Voltage Range	10 to 100V	160 to 500V
Nominal Capacitance Range	180 to 680000μF	
Capacitance Tolerance	±20% at 120Hz, +20°C	
Leakage Current	I ≤ 0.02CV (μA) or 5 (mA) whichever is smaller measured after 5 minutes application of rated working voltage at +20°C	
tan δ (120Hz, +20°C)	The values shown in the STANDARD RATINGS tables	
Low Temperature Characteristics	Impedance ratio max. at 120Hz	
	Working Voltage (V)	10~100 160~500
	Z-25°C / Z+20°C	- 8
	Z-40°C / Z+20°C	15 -
High Temperature Loading	Test time : 2,000 hours	Post test requirements at +20°C
	Test temperature : +105°C	Leakage current : ≤ Initial specified value
	Test conditions : Rated DC working voltage with rated ripple current	Cap. change : within ±20% of the initial measured value
		tan δ : ≤ 200% of the initial specified value
Shelf Life	At +105°C no voltage applied after 1,000 hours and then being stabilized at +20°C the capacitors shall meet the following limits	
	Leakage current : ≤ Initial specified value	
	Cap. change : within ±20% of the initial measured value	
	tan δ : ≤ 200% of the initial specified value	
Industrial Standard	JIS C - 5101-4 (IEC 60384-4)	

RIPPLE CURRENT MULTIPLIER

Frequency Coefficient

Coefficient	Freq. (Hz)	Rated Voltage				
		50	120	300	1k	10k~
<160V		0.80	1.00	1.08	1.15	1.15
≥160V		0.80	1.00	1.08	1.15	1.20

PART NUMBER SYSTEM (EXAMPLE : 350V 2700μF)

1	2 3	4 5 6	7	8 9	10	11 12	13 14
E	WT	278	M	2V	T	1L	OO

Type (Terminal Code)
 Case Length (100mm)
 Diameter (63.5mm)
 Voltage (350V)
 Tolerance (±20%)
 Capacitance (2700μF)
 Series
 E-CAP

CASE SIZE TABLE

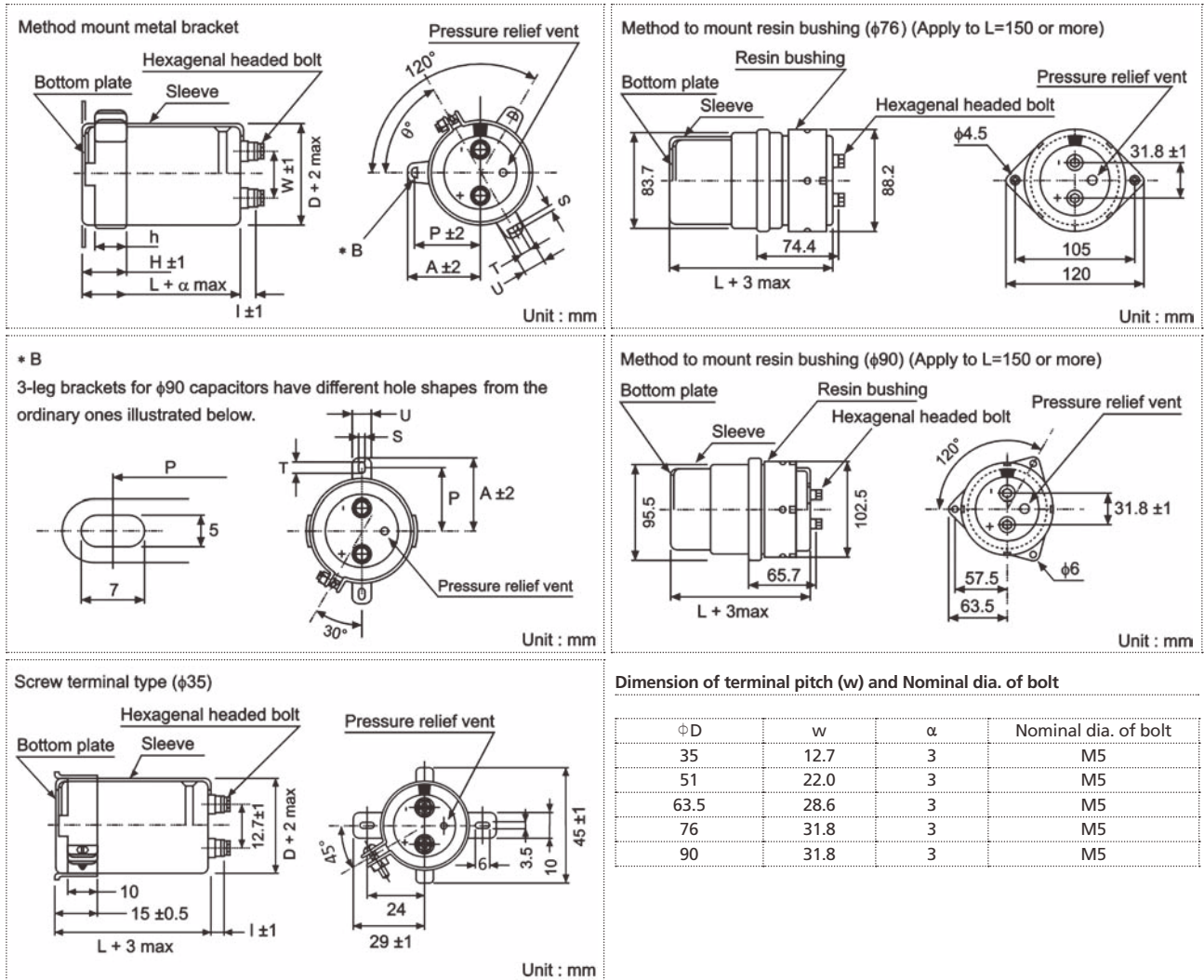

Dimensions of mounting bracket

Voltage (Code)		3 - Leg				2 - Leg				
Symbol	φD	51	63.5	76	90	35	51	63.5	76	90
P		32.5	38.1	44.5	50.8	24	33.2	40.5	46.5	53
A		38.5	43	49.2	58.5	29	40	46.5	53	59
T		7.5	8.0	7.0	8.0	6.0	6.0	7.0	6.0	6.0
S		5.0	5.0	5.0	5.0	3.5	4.5	4.5	4.5	4.5
U		12	14	14	18	10	14	14	14	14
θ°		60	60	60	60	30	30	30	30	30
H		20	25	30	35	15	25	35	35	35
h		15	20	24	25	10	15	20	20	20

STANDARD RATINGS

Voltage (Code)		10V (1A)			16V (1C)			25V (1E)		
SV		13			20			32		
Cap. (μF)	Code	Case Size	tan δ	Ripple Current	Case Size	tan δ	Ripple Current	Case Size	tan δ	Ripple Current
12000	129							35 x 50	0.35	3.7
15000	159							35 x 50	0.35	4.1
18000	189				35 x 50	0.40	4.2	35 x 60	0.35	4.8
22000	229				35 x 50	0.40	4.7	35 x 60	0.35	5.3
27000	279	35 x 50	0.45	4.9	35 x 60	0.40	5.5	35 x 80	0.35	6.4
33000	339	35 x 50	0.50	5.1	35 x 60	0.45	5.7	35 x 80	0.40	6.7
39000	399	35 x 60	0.50	5.9	35 x 80	0.45	6.8	35 x 100	0.40	7.8
47000	479	35 x 80	0.50	7.1	35 x 80	0.50	7.1	35 x 120	0.40	9.3
56000	569	35 x 80	0.60	7.1	35 x 100	0.50	8.4	51 x 80	0.45	9.7
68000	689	35 x 100	0.60	8.5	35 x 100	0.55	8.8	51 x 100	0.45	11.2
82000	829	35 x 100	0.65	8.9	51 x 80	0.55	10.7	51 x 100	0.50	11.2
100000	10T	35 x 120	0.65	10.7	51 x 80	0.65	10.8	51 x 120	0.50	14.8
120000	12T	51 x 80	0.75	11.0	51 x 100	0.65	13.1	63.5 x 100	0.65	14.9
150000	15T	51 x 100	0.80	13.2	51 x 120	0.70	15.3	63.5 x 120	0.65	17.9
180000	18T	51 x 120	0.80	15.7	51 x 120	0.80	15.7	63.5 x 120	0.80	17.9
220000	22T	51 x 120	0.85	16.8	63.5 x 120	0.85	19.2	76 x 120	0.85	21.3
270000	27T	63.5 x 120	1.00	19.6	63.5 x 120	1.00	19.6	76 x 120	1.00	21.7
330000	33T	63.5 x 120	1.20	19.7	76 x 120	1.30	21.1	76 x 140	1.20	23.4
390000	39T	76 x 120	1.50	21.3	76 x 120	1.50	21.3	90 x 140	1.50	24.9
470000	47T	76 x 120	1.80	21.4	76 x 140	1.60	24.2			
560000	56T	76 x 140	2.00	23.6	90 x 140	2.00	28.1			
680000	68T	90 x 140	2.40	26.0	90 x 140	2.40	28.5			

Maximum Allowable Ripple Current (Arms) at 105°C 120Hz
tan δ at 20°C 120Hz

Case Size ΦD x L (mm)

Voltage (Code)		35V (1V)			50V (1H)			63V (1J)		
SV		44			63			79		
Cap. (μF)	Code	Case Size	tan δ	Ripple Current	Case Size	tan δ	Ripple Current	Case Size	tan δ	Ripple Current
2700	278							35 x 50	0.20	2.3
3300	338							35 x 50	0.20	2.5
3900	398				35 x 50	0.20	2.8	35 x 50	0.20	2.8
4700	478				35 x 50	0.20	3.1	35 x 50	0.20	3.1
5600	568				35 x 50	0.20	3.3	35 x 60	0.20	3.5
6800	688				35 x 50	0.25	3.3	35 x 60	0.20	3.9
8200	828	35 x 50	0.30	3.3	35 x 60	0.25	3.8	35 x 80	0.20	4.7
10000	109	35 x 50	0.30	3.6	35 x 80	0.25	4.6	35 x 80	0.25	4.7
12000	129	35 x 60	0.30	4.2	35 x 80	0.25	5.1	35 x 100	0.25	5.5
15000	159	35 x 60	0.30	4.7	35 x 80	0.25	5.7	35 x 120	0.25	6.6
18000	189	35 x 80	0.30	5.7	35 x 100	0.25	6.7	51 x 80	0.25	7.4
22000	229	35 x 80	0.30	6.3	35 x 120	0.25	8.1	51 x 100	0.25	9.0
27000	279	35 x 100	0.30	7.5	51 x 80	0.25	9.1	51 x 120	0.25	10.9
33000	339	35 x 120	0.30	9.0	51 x 100	0.25	11.1	51 x 120	0.25	12.0
39000	399	51 x 80	0.35	9.2	51 x 120	0.25	13.1	63.5 x 100	0.30	12.5
47000	479	51 x 100	0.35	11.2	51 x 120	0.30	13.9	63.5 x 120	0.30	14.9
56000	569	51 x 100	0.40	11.4	63.5 x 100	0.35	13.9	63.5 x 120	0.30	16.3
68000	689	51 x 120	0.40	13.6	63.5 x 120	0.35	16.6	76 x 120	0.35	18.4
82000	829	63.5 x 100	0.45	14.8	76 x 120	0.40	18.9	76 x 140	0.40	20.0
100000	10T	63.5 x 120	0.45	17.6	76 x 120	0.45	19.5	76 x 140	0.50	20.0
120000	12T	63.5 x 120	0.55	17.6	76 x 120	0.55	19.5	90 x 140	0.60	21.8
150000	15T	76 x 120	0.65	19.8	90 x 140	0.60	23.9			
180000	18T	76 x 120	0.80	19.8	90 x 140	0.75	23.9			
220000	22T	76 x 140	0.80	23.4						
270000	27T	90 x 140	1.00	25.5						

Maximum Allowable Ripple Current (Arms) at 105°C 120Hz
tan δ at 20°C 120Hz

Case Size ΦD x L (mm)

Specifications are subject to change without notice. Should a safety or technical concern arise regarding the product, please be sure to contact our sales offices or agents immediately.

STANDARD RATINGS

Voltage (Code)		80V (1K)			100V (2A)			160V (2C)		
SV		100			125			200		
Cap. (µF)	Code	Case Size	tan δ	Ripple Current	Case Size	tan δ	Ripple Current	Case Size	tan δ	Ripple Current
560	567							35 x 50	0.15	1.2
680	687							35 x 50	0.15	1.3
820	827							35 x 50	0.15	1.4
1000	108							35 x 50	0.15	1.6
1200	128							35 x 60	0.15	1.9
1500	158							35 x 60	0.15	2.1
1800	188				35 x 50	0.10	2.7	35 x 80	0.15	2.5
2200	228	35 x 50	0.15	2.4	35 x 50	0.10	3.0	35 x 80	0.15	2.8
2700	278	35 x 50	0.15	2.7	35 x 60	0.10	3.5	35 x 100	0.15	3.3
3300	338	35 x 50	0.15	3.0	35 x 80	0.10	4.2	35 x 120	0.15	3.8
3900	398	35 x 60	0.15	3.4	35 x 80	0.12	4.2	51 x 80	0.20	3.8
4700	478	35 x 60	0.15	3.7	35 x 100	0.12	5.0	51 x 100	0.20	4.6
5600	568	35 x 80	0.15	4.5	35 x 100	0.12	5.4	51 x 100	0.20	5.1
6800	688	35 x 80	0.15	4.9	35 x 120	0.15	5.8	51 x 120	0.20	6.1
8200	828	35 x 100	0.20	5.1	51 x 80	0.15	6.4	63.5 x 100	0.20	7.0
10000	109	35 x 120	0.20	6.1	51 x 100	0.15	7.8	63.5 x 120	0.20	8.4
12000	129	51 x 80	0.20	6.7	51 x 120	0.15	9.3	76 x 100	0.20	9.4
15000	159	51 x 100	0.20	8.3	51 x 120	0.15	10.4	76 x 120	0.20	11.4
18000	189	51 x 120	0.20	9.9	63.5 x 100	0.20	10.4	76 x 140	0.20	13.4
22000	229	51 x 120	0.20	11.0	63.5 x 120	0.20	12.5	90 x 140	0.25	14.5
27000	279	63.5 x 100	0.25	11.4	76 x 120	0.25	13.7	90 x 140	0.25	16.0
33000	339	76 x 100	0.25	13.9	76 x 120	0.25	15.2			
39000	399	76 x 100	0.30	13.9	76 x 140	0.30	16.1			
47000	479	76 x 120	0.30	16.5	90 x 140	0.30	19.3			
56000	569	76 x 120	0.30	18.1	90 x 140	0.30	21.1			
68000	689	76 x 140	0.35	19.7						
82000	829	90 x 140	0.40	22.1						

Maximum Allowable Ripple Current (Arms) at 105°C 120Hz
tan δ at 20°C 120Hz

Case Size ΦD x L (mm)

Voltage (Code)		200V (2D)			250V (2E)			315V (2F)		
SV		250			300			365		
Cap. (µF)	Code	Case Size	tan δ	Ripple Current	Case Size	tan δ	Ripple Current	Case Size	tan δ	Ripple Current
180	187							35 x 50	0.10	0.8
220	227							35 x 50	0.10	0.9
270	277				35 x 50	0.15	0.8	35 x 50	0.10	1.0
330	337	35 x 50	0.15	0.9	35 x 50	0.15	0.9	35 x 50	0.10	1.1
390	397	35 x 50	0.15	1.0	35 x 50	0.15	1.0	35 x 50	0.10	1.2
470	477	35 x 50	0.15	1.1	35 x 50	0.15	1.1	35 x 60	0.10	1.4
560	567	35 x 50	0.15	1.2	35 x 50	0.15	1.2	35 x 60	0.10	1.5
680	687	35 x 50	0.15	1.3	35 x 60	0.15	1.4	35 x 80	0.10	1.7
820	827	35 x 50	0.15	1.4	35 x 80	0.15	1.6	35 x 80	0.15	1.7
1000	108	35 x 60	0.15	1.7	35 x 80	0.20	1.6	35 x 100	0.15	2.0
1200	128	35 x 60	0.15	1.9	35 x 80	0.20	1.8	35 x 120	0.15	2.4
1500	158	35 x 80	0.15	2.3	35 x 100	0.20	2.1	51 x 80	0.15	2.7
1800	188	35 x 80	0.15	2.5	35 x 120	0.20	2.5	51 x 100	0.15	3.3
2200	228	35 x 100	0.15	3.0	51 x 80	0.20	2.9	51 x 120	0.15	4.0
2700	278	35 x 120	0.15	3.6	51 x 100	0.20	3.5	51 x 120	0.15	4.4
3300	338	51 x 80	0.15	4.1	51 x 120	0.20	4.2	63.5 x 100	0.15	5.1
3900	398	51 x 100	0.15	4.9	51 x 120	0.20	4.6	63.5 x 120	0.15	6.0
4700	478	63.5 x 100	0.20	5.3	63.5 x 120	0.20	5.7	76 x 100	0.15	6.8
5600	568	63.5 x 100	0.20	5.8	63.5 x 120	0.20	6.3	76 x 120	0.15	8.0
6800	688	63.5 x 120	0.20	6.9	76 x 120	0.20	7.7	76 x 130	0.15	9.2
8200	828	63.5 x 120	0.20	7.6	76 x 120	0.20	8.4	90 x 140	0.15	11.4
10000	109	76 x 120	0.20	9.3	76 x 140	0.20	10.0	90 x 140	0.15	12.6
12000	129	76 x 120	0.20	10.2	90 x 140	0.20	11.9			
15000	159	76 x 140	0.20	12.2						
18000	189	90 x 140	0.25	13.1						

Maximum Allowable Ripple Current (Arms) at 105°C 120Hz
tan δ at 20°C 120Hz

Case Size ΦD x L (mm)

Specifications are subject to change without notice. Should a safety or technical concern arise regarding the product, please be sure to contact our sales offices or agents immediately.

STANDARD RATINGS

Voltage (Code)		350V (2V)			400V (2G)			450V (2W)		
SV		400			450			500		
Cap. (μF)	Code	Case Size	tan δ	Ripple Current	Case Size	tan δ	Ripple Current	Case Size	tan δ	Ripple Current
470	477							51 x 80	0.15	1.4
680	687							51 x 80	0.15	1.6
1000	108				51 x 80	0.15	2.2	51 x 80	0.15	1.8
1200	128	51 x 80	0.15	2.4	51 x 80	0.15	2.5			
1500	158	51 x 80	0.15	2.8	51 x 115	0.15	3.0	51 x 115	0.15	3.5
1800	188	51 x 105	0.15	3.2						
2200	228	51 x 115	0.15	3.8	63.5 x 95	0.15	4.0	63.5 x 115	0.15	5.0
2700	278	63.5 x 95	0.15	4.5				76 x 100	0.15	5.8
3300	338				63.5 x 115	0.15	5.0	76 x 100	0.15	6.5
3900	398	76 x 90	0.15	6.0						
4700	478				76 x 115	0.15	7.0	76 x 130	0.15	8.0
5600	568	76 x 130	0.15	8.3	76 x 140	0.15	8.5	76 x 155	0.15	9.0
6800	688	76 x 140	0.15	9.5	90 x 130	0.15	10.0	90 x 155	0.15	10.5
8200	828	90 x 140	0.15	11.4				90 x 195	0.15	13.0
10000	109							90 x 195	0.15	14.0
12000	129							90 x 230	0.15	15.7
15000	159							90 x 250	0.15	18.2

Maximum Allowable Ripple Current (Arms) at 105°C 120Hz
tan δ at 20°C 120Hz

Case Size ΦD x L (mm)

Voltage (Code)		500V (2H)		
SV		550		
Cap. (μF)	Code	Case Size	tan δ	Ripple Current
330	337	51 x 80	0.15	1.1
470	477	51 x 80	0.15	1.3
680	687	51 x 105	0.15	1.8
1000	108	51 x 115	0.15	2.1
1500	158	63.5 x 115	0.15	3.0
2200	228	63.5 x 130	0.15	3.7
2700	278	63.5 x 150	0.15	4.4
		76 x 115	0.15	4.4
3300	338	63.5 x 170	0.15	5.2
		76 x 155	0.15	5.2
3900	398	76 x 155	0.15	5.8
4700	478	76 x 190	0.15	6.9
		90 x 155	0.15	6.9
5600	568	90 x 155	0.15	7.2
6800	688	90 x 170	0.15	8.3
8200	828	90 x 220	0.15	10.2
10000	109	90 x 250	0.15	12.0

Maximum Allowable Ripple Current (Arms) at 105°C 120Hz
tan δ at 20°C 120Hz

Case Size ΦD x L (mm)

Specifications are subject to change without notice. Should a safety or technical concern arise regarding the product, please be sure to contact our sales offices or agents immediately.

FEATURES

- High voltage and capacitance, high ripple, high reliability, guarantee 5,000 hours load life at 85°C.
- Suitable for use in changeable current circuits in changeable frequencies air-condition etc.



SPECIFICATIONS

Item	Performance Characteristics											
Operating Temperature Range	-40 to +85°C	-25 to +85°C										
Rated Working Voltage Range	10 to 100V	160 to 550V										
Nominal Capacitance Range	1000 to 1500000µF											
Capacitance Tolerance	±20% at 120Hz, +20°C											
Leakage Current	I ≤ 0.02CV (µA) or 5 (mA) whichever is smaller measured after 5 minutes application of rated working voltage at +20°C											
tan δ (120Hz, +20°C)	Φ D	L	V	10	16	25	35	50	63	80	100	
	35	80~100		0.6	0.4	0.4	0.3	0.3	0.3	0.2	0.1	
				0.7	0.6	0.4	0.3	0.3	0.2	0.2		
	51	70~100		0.9	0.6	0.5	0.4	0.3	0.3	0.2	0.2	
			120~140	1	0.8	0.5	0.4	0.3	0.3	0.2	0.2	
	63.5	100		0.9	—	—	0.5	0.4	0.3	0.3	—	
			105~220	1.2	0.8	0.7	—	—	0.3	0.3	0.2	
	76	100		1.6	—	—	0.7	—	—	—	—	
			120~140	1.6	1.1	0.8	0.8	0.6	0.5	0.4	0.3	
	90	140~220		2	1.5	1	0.9	0.8	0.6	0.4	0.3	
			100	250	2.4	1.5	1	0.9	0.8	0.6	0.4	0.3
	Low Temperature Characteristics	Φ D	L	V	160~250	350~450						
		35	80~120		0.15	0.25						
					0.15	0.25						
				0.20	0.25							
63.5		90~190		0.20	0.25							
				0.20	0.25							
76		90~220		0.20	0.25							
			0.20	0.25								
90	130~230		0.20	0.25								
			0.25	0.25								
High Temperature Loading	Impedance ratio max. at 120Hz		Working Voltage (V)		10~100	160~500						
	Z-25°C / Z+20°C				—	8						
	Z-40°C / Z+20°C				15	—						
Shelf Life	Test time : 5,000 hours		Post test requirements at +20°C									
	Test temperature : +85°C		Leakage current : ≤ Initial specified value									
Industrial Standard	Test conditions : Rated DC working voltage with rated ripple current		Cap. change : within ±20% of the initial measured value									
			tan δ : ≤ 200% of the initial specified value									
Frequency Coefficient	At +85°C no voltage applied after 1,000 hours and then being stabilized at +20°C the capacitors shall meet the following limits											
	Leakage current : ≤ Initial specified value											
Cap. change : within ±20% of the initial measured value												
tan δ : ≤ 200% of the initial specified value												
JIS C - 5101-4 (IEC 60384-4)												

RIPPLE CURRENT MULTIPLIER

Frequency Coefficient

Coefficient	Rated Voltage	50	120	300	1k	10k~
<160V		0.80	1.00	1.08	1.15	1.15
≥160V		0.80	1.00	1.08	1.15	1.20

PART NUMBER SYSTEM (EXAMPLE : 400V 2200µF)

1	23	456	7	89	10	11 12	13 14
E	WX	228	M	2G	S	1M	OO



CASE SIZE TABLE

Method mount metal bracket

Unit : mm

Method to mount resin bushing (φ76) (Apply to L=150 or more)

Unit : mm

* B

3-leg brackets for φ90 capacitors have different hole shapes from the ordinary ones illustrated below.

Unit : mm

Method to mount resin bushing (φ90) (Apply to L=150 or more)

Unit : mm

Screw terminal type (φ35)

Unit : mm

Dimension of terminal pitch (w) and Nominal dia. of bolt

ΦD	w	α	Nominal dia. of bolt
35	12.7	3	M5
51	22.0	3	M5
63.5	28.6	3	M5
76	31.8	3	M5
90	31.8	3	M5

Dimensions of mounting bracket

Voltage (Code)		3 - Leg				2 - Leg				
Symbol	ΦD	51	63.5	76	90	35	51	63.5	76	90
P		32.5	38.1	44.5	50.8	24	33.2	40.5	46.5	53
A		38.5	43	49.2	58.5	29	40	46.5	53	59
T		7.5	8.0	7.0	8.0	6.0	6.0	7.0	6.0	6.0
S		5.0	5.0	5.0	5.0	3.5	4.5	4.5	4.5	4.5
U		12	14	14	18	10	14	14	14	14
θ°		60	60	60	60	30	30	30	30	30
H		20	25	30	35	15	25	35	35	35
h		15	20	24	25	10	15	20	20	20

STANDARD RATINGS

Voltage (Code)		10V (1A)		16V (1C)		25V (1E)		35V (1V)	
SV		13		20		32		44	
Cap. (µF)	Code	Case Size	Ripple Current	Case Size	Ripple Current	Case Size	Ripple Current	Case Size	Ripple Current
33000	339					35 x 80	6.2	35 x 80	6.2
47000	479	35 x 80	6.0	35 x 80	6.4	35 x 100	8.2	35 x 120	8.2
68000	689	35 x 80	7.2	35 x 100	7.9	35 x 120	9.4	51 x 80	9.3
100000	10T	35 x 100	8.8	35 x 120	10.6	51 x 100	12.0	51 x 120	13.6
150000	15T	51 x 80	10.7	51 x 100	11.5	51 x 120	15.3	63.5 x 100	14.5
220000	22T	51 x 100	13.0	51 x 120	15.6	63.5 x 120	18.9	76 x 100	16.8
330000	33T	63.5 x 100	15.9	63.5 x 120	25.1	76 x 120	24.8	76 x 140	24.8
470000	47T	63.5 x 120	19.0	76 x 120	30.5	90 x 170	30.8	90 x 170	32.6
680000	68T	76 x 120	22.8	90 x 170	33.0	90 x 220	33.3	90 x 220	35.2
1000000	10M	90 x 170	27.7	90 x 220	36.0				
1500000	15M	90 x 220	33.9						

Maximum Allowable Ripple Current (Arms) at 85°C 120Hz

Case Size Φ D x L (mm)

Voltage (Code)		50V (1H)		63V (1J)		80V (1K)		100V (2A)	
SV		63		79		100		125	
Cap. (µF)	Code	Case Size	Ripple Current	Case Size	Ripple Current	Case Size	Ripple Current	Case Size	Ripple Current
4700	478							35 x 80	3.8
6800	688							35 x 100	4.5
10000	109			35 x 80	4.1	35 x 100	4.6	51 x 80	5.4
15000	159	35 x 80	5.4	35 x 100	5.5	35 x 120	6.0	51 x 100	6.6
22000	229	35 x 100	6.1	35 x 120	7.1	51 x 100	7.2	63.5 x 100	7.7
33000	339	51 x 70	7.0	51 x 100	9.7	51 x 120	9.2	76 x 100	10.8
47000	479	51 x 90	8.6	51 x 120	11.7	63.5 x 120	13.8	76 x 120	14.9
68000	689	51 x 120	11.9	63.5 x 120	16.2	63.5 x 140	15.5	76 x 150	18.8
100000	10T	63.5 x 100	14.2	63.5 x 140	20.8	90 x 140	23.4	90 x 170	22.1
150000	15T	76 x 120	18.6	90 x 140	28.6	90 x 170	26.5	90 x 220	27.0
220000	22T	90 x 140	20.3	90 x 170	28.3	90 x 220	28.9		
330000	33T	90 x 170	25.3	90 x 220	31.2				
470000	47T	90 x 220	33.2						

Maximum Allowable Ripple Current (Arms) at 85°C 120Hz

Case Size Φ D x L (mm)

Voltage (Code)		160V (2C)		200V (2D)		250V (2E)		350V (2V)	
SV		200		250		300		400	
Cap. (µF)	Code	Case Size	Ripple Current	Case Size	Ripple Current	Case Size	Ripple Current	Case Size	Ripple Current
1000	108					35 x 80	2.4		
1500	158			35 x 80	2.9	35 x 100	3.0		
2200	228	35 x 80	3.2	35 x 100	3.5	51 x 80	4.0	51 x 100	7.7
2700	278							51 x 120	9.3
3300	338	35 x 120	4.7	51 x 80	4.8	51 x 100	5.4	51 x 130	10.8
3900	398							63.5 x 120	12.1
4700	478	51 x 80	5.0	51 x 100	6.3	63.5 x 100	7.3	63.5 x 130	14.0
5600	568							63.5 x 160	16.6
								76 x 120	16.1
6800	688	51 x 100	6.4	51 x 140	7.3	63.5 x 120	8.9	63.5 x 190	20.0
								76 x 130	18.6
8200	828							76 x 160	22.2
10000	109	63.5 x 100	9.1	63.5 x 120	9.8	76 x 120	11.8	76 x 170	25.2
12000	129							90 x 160	29.1
15000	159	76 x 100	12.0	76 x 120	13.0	90 x 140	16.4	90 x 190	35.7
22000	229	76 x 140	16.9	90 x 140	15.9	90 x 170	17.9		
33000	339	90 x 140	19.2	90 x 170	19.5	90 x 220	19.7		
47000	479	90 x 170	20.6	90 x 220	20.9				
68000	689	90 x 220	22.3						

Maximum Allowable Ripple Current (Arms) at 85°C 120Hz

Case Size Φ D x L (mm)

Specifications are subject to change without notice. Should a safety or technical concern arise regarding the product, please be sure to contact our sales offices or agents immediately.

STANDARD RATINGS

Voltage (Code)		400V (2G)		450V (2W)		500V (2H)		550V (25)	
SV		450		500		550		600	
Cap. (μF)	Code	Case Size	Ripple Current	Case Size	Ripple Current	Case Size	Ripple Current	Case Size	Ripple Current
1000	108	51 x 80	5.0	51 x 80	5.0	51 x 110	4.2	51 x 130	4.3
1200	128	51 x 80	5.8	51 x 100	5.7	63.5 x 90	4.8	63.5 x 110	5.0
1500	158	51 x 100	6.4	51 x 100	6.3	63.5 x 90	5.5	63.5 x 130	6.0
1800	188	51 x 100	7.0	51 x 120	7.6	63.5 x 110	6.5	76 x 100	6.4
2200	228	63.5 x 90	8.3	51 x 130	8.8	63.5 x 130	7.7	76 x 110	7.4
		51 x 140	8.5	63.5 x 100	8.5				
2700	278	51 x 130	9.8	63.5 x 120	10.1	76 x 110	8.8	76 x 120	8.5
3300	338	63.5 x 120	11.1	63.5 x 130	11.7	76 x 130	10.4	76 x 140	10.1
				76 x 110	12.0				
3900	398	63.5 x 130	12.7	63.5 x 160	13.8	76 x 130	11.4	76 x 160	11.7
				76 x 120	13.4				
4700	478	63.5 x 130	13.8	76 x 130	15.5	90 x 130	13.7	90 x 150	13.7
		63.5 x 160	15.2	90 x 120	15.0				
		76 x 120	14.7						
5600	568	63.5 x 190	18.2	76 x 155	18.0	90 x 150	15.9	90 x 170	15.8
		76 x 130	16.9	90 x 155	18.3				
6800	688	76 x 150	18.2	76 x 170	20.7	90 x 170	18.5	90 x 200	18.6
				90 x 150	21.0				
				76 x 155	21.8				
8200	828	76 x 170	22.8	90 x 160	24.1	90 x 190	21.4		
		90 x 150	23.0						
10000	109	90 x 160	26.6	90 x 155	26.7				
				90 x 170	27.8				
12000	129	90 x 170	30.0	90 x 230	29.5				
15000	159	90 x 230	32.0						

Maximum Allowable Ripple Current (Arms) at 85°C 120Hz

Case Size Φ D x L (mm)

Specifications are subject to change without notice. Should a safety or technical concern arise regarding the product, please be sure to contact our sales offices or agents immediately.

FEATURES

- Load life of 5,000 hours application of ripple current at +105°C.
- High reliability products.



SPECIFICATIONS

Item	Performance Characteristics	
Operating Temperature Range	-40 to +105°C	-25 to +105°C
Rated Working Voltage Range	10 to 100V	160 to 500V
Nominal Capacitance Range	330 to 390000µF	
Capacitance Tolerance	±20% at 120Hz, +20°C	
Leakage Current	I ≤ 0.02CV (µA) or 5 (mA) whichever is smaller measured after 5 minutes application of rated working voltage at +20°C	
tan δ (120Hz, +20°C)	The values shown in the STANDARD RATINGS tables	
Low Temperature Characteristics	Impedance ratio max. at 120Hz	
	Working Voltage (V)	10~100 160~500
	Z-25°C / Z+20°C	- 8
	Z-40°C / Z+20°C	15 -
High Temperature Loading	Test time : 5,000 hours	Post test requirements at +20°C
	Test temperature : +105°C	Leakage current : ≤ Initial specified value
	Test conditions : Rated DC working voltage with rated ripple current	Cap. change : within ±20% of the initial measured value
		tan δ : ≤ 200% of the initial specified value
Shelf Life	At +105°C no voltage applied after 1,000 hours and then being stabilized at +20°C the capacitors shall meet the following limits	
	Leakage current : ≤ Initial specified value	
	Cap. change : within ±20% of the initial measured value	
	tan δ : ≤ 200% of the initial specified value	
Industrial Standard	JIS C - 5101-4 (IEC 60384-4)	

RIPPLE CURRENT MULTIPLIER

Frequency Coefficient

Coefficient	Freq. (Hz)					
Rated Voltage	50	120	300	1k	10k~	
<160V	0.80	1.00	1.08	1.15	1.15	
≥160V	0.80	1.00	1.08	1.15	1.20	

PART NUMBER SYSTEM (EXAMPLE : 350V 6800µF)

1	2 3	4 5 6	7	8 9	10	11 12	13 14	
E	WF	688	M	2V	U	1P	OO	

Type (Terminal Code)
 Case Length (130mm)
 Diameter (76.2mm)
 Voltage (350V)
 Tolerance (±20%)
 Capacitance (6800µF)
 Series
 E-CAP

CASE SIZE TABLE

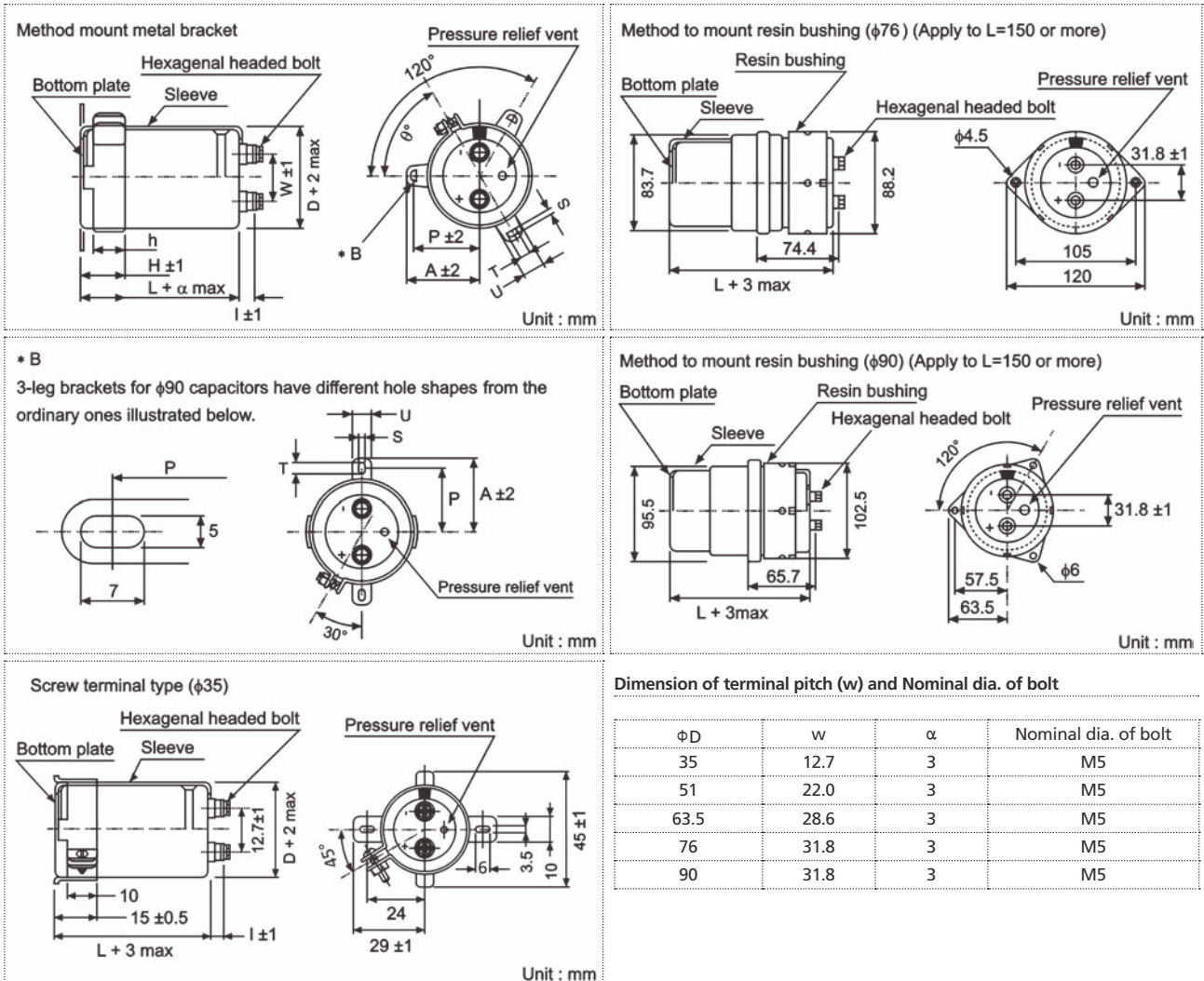

Dimensions of mounting bracket

Voltage (Code)		3 - Leg				2 - Leg				
Symbol	φD	51	63.5	76	90	35	51	63.5	76	90
P		32.5	38.1	44.5	50.8	24	33.2	40.5	46.5	53
A		38.5	43	49.2	58.5	29	40	46.5	53	59
T		7.5	8.0	7.0	8.0	6.0	6.0	7.0	6.0	6.0
S		5.0	5.0	5.0	5.0	3.5	4.5	4.5	4.5	4.5
U		12	14	14	18	10	14	14	14	14
θ°		60	60	60	60	30	30	30	30	30
H		20	25	30	35	15	25	35	35	35
h		15	20	24	25	10	15	20	20	20

STANDARD RATINGS

Voltage (Code)		10V (1A)			16V (1C)			25V (1E)		
SV		13			20			32		
Cap. (µF)	Code	Case Size	tan δ	Ripple Current	Case Size	tan δ	Ripple Current	Case Size	tan δ	Ripple Current
12000	129							35 x 80	0.35	3.3
15000	159				35 x 50	0.45	2.9	35 x 80	0.35	3.7
18000	189				35 x 80	0.45	3.5	35 x 80	0.35	4.0
22000	229				35 x 80	0.45	3.9	35 x 80	0.35	4.5
27000	279	35 x 80	0.45	4.3	35 x 80	0.45	4.3	35 x 100	0.40	5.0
33000	339	35 x 80	0.45	4.7	35 x 100	0.50	4.8	35 x 120	0.40	5.9
39000	399	35 x 80	0.45	5.3	35 x 100	0.50	5.3	51 x 80	0.40	6.5
47000	479	35 x 100	0.45	6.1	35 x 120	0.50	6.2	51 x 100	0.40	7.9
56000	569	35 x 100	0.50	6.2	51 x 80	0.60	6.3	51 x 120	0.40	8.8
68000	689	35 x 120	0.60	6.8	51 x 100	0.60	7.6	51 x 120	0.50	9.1
82000	829	51 x 80	0.60	7.8	51 x 120	0.70	8.3	63.5 x 100	0.50	10.6
100000	10T	51 x 100	0.70	8.5	51 x 120	0.70	9.2	63.5 x 120	0.60	11.4
120000	12T	51 x 100	0.70	9.5	63.5 x 100	0.80	9.9	76 x 100	0.60	12.8
150000	15T	63.5 x 100	0.80	11.0	76 x 100	0.80	12.3	76 x 120	0.75	13.7
180000	18T	63.5 x 100	0.80	12.1	76 x 120	0.80	14.5	76 x 140	0.76	16.1
220000	22T	76 x 100	1.00	13.2	76 x 140	1.00	15.2	90 x 140	1.00	16.6
270000	27T	76 x 120	1.20	14.4	90 x 140	1.20	16.8			
330000	33T	76 x 140	1.20	17.0						
390000	39T	90 x 140	1.40	18.6						

Maximum Allowable Ripple Current (Arms) at 105°C 120Hz
tan δ at 20°C 120Hz

Case Size ΦD x L (mm)

Voltage (Code)		35V (1V)			50V (1H)			63V (1J)		
SV		44			63			79		
Cap. (µF)	Code	Case Size	tan δ	Ripple Current	Case Size	tan δ	Ripple Current	Case Size	tan δ	Ripple Current
2700	278							35 x 50	0.19	1.9
3300	338							35 x 50	0.15	2.1
3900	398				35 x 50	0.20	2.0	35 x 80	0.20	2.7
4700	478				35 x 50	0.25	2.2	35 x 80	0.20	2.9
5600	568				35 x 80	0.25	2.8	35 x 80	0.20	3.2
6800	688				35 x 80	0.25	3.0	35 x 80	0.20	3.5
8200	828	35 x 80	0.30	3.0	35 x 80	0.25	3.3	35 x 100	0.25	4.2
10000	109	35 x 80	0.30	3.3	35 x 80	0.25	3.7	35 x 120	0.25	4.3
12000	129	35 x 80	0.30	3.6	35 x 100	0.25	4.4	51 x 80	0.25	4.8
15000	159	35 x 80	0.30	4.1	35 x 120	0.30	4.7	51 x 100	0.25	5.9
18000	189	35 x 100	0.30	4.8	51 x 80	0.35	4.8	51 x 120	0.30	6.3
22000	229	35 x 120	0.35	5.2	51 x 100	0.35	5.9	51 x 120	0.30	6.7
27000	279	51 x 80	0.40	5.9	51 x 120	0.35	7.0	63.5 x 120	0.30	8.8
33000	339	51 x 100	0.40	6.6	63.5 x 100	0.40	7.6	76 x 120	0.35	10.0
39000	399	51 x 120	0.40	7.8	63.5 x 120	0.40	8.9	76 x 140	0.35	12.5
47000	479	51 x 120	0.45	8.0	63.5 x 120	0.40	9.8	90 x 140	0.40	13.8
56000	569	63.5 x 100	0.45	9.2	76 x 120	0.40	11.9			
68000	689	63.5 x 120	0.45	11.0	76 x 140	0.45	13.1			
82000	829	76 x 120	0.50	12.7	90 x 140	0.50	14.8			
100000	10T	76 x 140	0.60	13.5						
120000	12T	90 x 140	0.60	16.1						

Maximum Allowable Ripple Current (Arms) at 105°C 120Hz
tan δ at 20°C 120Hz

Case Size ΦD x L (mm)

Specifications are subject to change without notice. Should a safety or technical concern arise regarding the product, please be sure to contact our sales offices or agents immediately.

STANDARD RATINGS

Voltage (Code)		80V (1K)			100V (2A)			160V (2C)		
SV		100			125			200		
Cap. (μF)	Code	Case Size	tan δ	Ripple Current	Case Size	tan δ	Ripple Current	Case Size	tan δ	Ripple Current
680	687							35 x 50	0.15	1.1
820	827							35 x 80	0.15	1.2
1000	108							35 x 80	0.15	1.3
1200	128				35 x 50	0.15	1.4	35 x 80	0.15	1.5
1500	158				35 x 80	0.15	1.6	35 x 80	0.15	1.7
1800	188				35 x 80	0.15	1.8	35 x 100	0.15	2.0
2200	228	35 x 50	0.15	1.9	35 x 80	0.15	2.0	35 x 120	0.15	2.3
2700	278	35 x 80	0.15	2.2	35 x 80	0.15	2.4	35 x 120	0.15	2.7
3300	338	35 x 80	0.15	2.5	35 x 100	0.15	2.8	51 x 100	0.15	3.3
3900	398	35 x 80	0.15	2.9	35 x 120	0.15	3.1	51 x 120	0.15	3.8
4700	478	35 x 100	0.15	3.1	51 x 80	0.15	3.6	51 x 120	0.15	4.2
5600	568	35 x 100	0.15	3.6	51 x 100	0.15	4.3	51 x 120	0.15	4.7
6800	688	35 x 120	0.20	4.1	51 x 120	0.15	5.0	63.5 x 120	0.15	5.7
8200	828	51 x 80	0.20	4.8	51 x 120	0.15	5.5	76 x 100	0.20	6.4
10000	109	51 x 100	0.20	5.6	63.5 x 100	0.15	6.4	76 x 120	0.20	6.6
12000	129	51 x 100	0.20	6.1	63.5 x 120	0.20	6.6	76 x 140	0.20	7.8
15000	159	51 x 120	0.20	7.4	76 x 100	0.20	7.5	90 x 140	0.20	9.5
18000	189	63.5 x 120	0.25	8.0	76 x 120	0.25	8.0			
22000	229	76 x 100	0.25	9.1	76 x 140	0.25	9.4			
27000	279	76 x 120	0.30	9.7	90 x 140	0.30	10.4			
33000	339	76 x 140	0.30	11.5						
39000	399	90 x 140	0.30	12.5						

Maximum Allowable Ripple Current (Arms) at 105°C 120Hz
tan δ at 20°C 120Hz

Case Size ΦD x L (mm)

Voltage (Code)		200V (2G)			250V (2W)			350V (2H)		
SV		250			300			400		
Cap. (μF)	Code	Case Size	tan δ	Ripple Current	Case Size	tan δ	Ripple Current	Case Size	tan δ	Ripple Current
330	337				35 x 50	0.15	0.7			
390	397				35 x 80	0.15	0.8			
470	477	35 x 50	0.15	0.9	35 x 80	0.15	0.9			
560	567	35 x 80	0.15	1.0	35 x 80	0.15	1.0			
680	687	35 x 80	0.15	1.1	35 x 100	0.15	1.2			
820	827	35 x 80	0.15	1.3	35 x 100	0.15	1.4	51 x 80	0.25	3.3
1000	108	35 x 80	0.15	1.5	35 x 120	0.15	1.6			
1200	128	35 x 100	0.15	1.7	51 x 80	0.15	1.8			
1500	158	35 x 120	0.15	1.9	51 x 90	0.15	2.1	51 x 90	0.25	5.2
1800	188	35 x 120	0.15	2.2	51 x 100	0.15	2.4			
2200	228	51 x 80	0.15	2.7	51 x 110	0.15	2.7	51 x 110	0.25	7.0
2700	278	51 x 100	0.15	3.2	63.5 x 90	0.15	3.2	51 x 130	0.25	8.4
								63.5 x 90	0.25	8.1
3300	338	51 x 120	0.15	3.5	63.5 x 120	0.15	4.0	51 x 150	0.25	9.9
3900	398	63.5 x 100	0.15	4.0	76 x 90	0.15	4.2	63.5 x 130	0.25	11.5
								76 x 90	0.25	10.8
4700	478	63.5 x 120	0.15	4.7	76 x 120	0.15	5.2			
5600	568	76 x 100	0.15	5.3	76 x 140	0.15	6.1	63.5 x 150	0.25	14.7
6800	688	76 x 120	0.15	6.3	76 x 140	0.15	6.7	76 x 140	0.25	17.4
8200	828	76 x 140	0.20	6.4				76 x 150	0.25	19.6
10000	109	90 x 140	0.20	7.7				76 x 190	0.25	23.0
15000	159							90 x 190	0.25	30.6
22000	229							90 x 260	0.25	42.7

Maximum Allowable Ripple Current (Arms) at 105°C 120Hz
tan δ at 20°C 120Hz

Case Size ΦD x L (mm)

Specifications are subject to change without notice. Should a safety or technical concern arise regarding the product, please be sure to contact our sales offices or agents immediately.

STANDARD RATINGS

Voltage (Code)		400 (2G)			450V (2W)			500V (2H)		
SV		450			500			550		
Cap. (μF)	Code	Case Size	tan δ	Ripple Current	Case Size	tan δ	Ripple Current	Case Size	tan δ	Ripple Current
470	477							51 x 80	0.25	2.4
560	567				51 x 80	0.25	2.6			
680	687	51 x 80	0.25	3.0						
820	827							51 x 90	0.25	3.6
1000	108				51 x 90	0.25	4.0	51 x 110	0.25	4.4
1200	128	51 x 90	0.25	4.7	51 x 110	0.25	4.8	51 x 130	0.25	5.2
1500	158							63.5 x 90	0.25	5.0
1800	188	51 x 110	0.25	6.3				51 x 150	0.25	6.3
					51 x 130	0.25	6.4			
					63.5 x 90	0.25	6.2	63.5 x 110	0.25	6.8
2200	228	51 x 130	0.25	7.5	51 x 150	0.25	7.6			
		63.5 x 90	0.25	7.3	63.5 x 110	0.25	7.5			
2700	278	51 x 150	0.25	8.9	63.5 x 130	0.25	8.9	63.5 x 150	0.25	9.6
		63.5 x 110	0.25	8.8	76 x 110	0.25	9.1	76 x 110	0.25	9.2
3300	338	63.5 x 130	0.25	10.5	63.5 x 150	0.25	10.6			
		76 x 90	0.25	9.9	76 x 110	0.25	10.6			
3900	398				76 x 130	0.25	11.9	76 x 150	0.25	12.7
								90 x 130	0.25	11.9
4700	478	63.5 x 150	0.25	13.4						
		76 x 130	0.25	13.9	76 x 140	0.25	13.6			
5600	568				76 x 150	0.25	13.8			
6800	688	76 x 150	0.25	17.9	76 x 190	0.25	17.3			
		90 x 130	0.25	17.2	90 x 150	0.25	16.7	90 x 190	0.25	18.8
8200	828	76 x 190	0.25	20.8						
		90 x 150	0.25	20.1						
10000	109				90 x 200	0.25	23.3	90 x 260	0.25	26.3
12000	129	90 x 190	0.25	27.4						
15000	159				90 x 250	0.25	31.7			

Maximum Allowable Ripple Current (Arms) at 105°C 120Hz
tan δ at 20°C 120Hz

Case Size ΦD x L (mm)

FEATURES

- Load life of 10,000 hours application of ripple current at 85°C.
- High ripple, high reliability.
- Best for use in industrial power supplies for inverter circuitry.



SPECIFICATIONS

Item	Performance Characteristics	
Operating Temperature Range	-25 to +85°C	
Rated Working Voltage Range	350 to 500V	
Nominal Capacitance Range	470 to 22000µF	
Capacitance Tolerance	±20% at 120Hz, +20°C	
Leakage Current	I ≤ 0.02CV (µA) or 5 (mA) whichever is smaller measured after 5 minutes application of rated working voltage at +20°C	
tan δ (120Hz, +20°C)	Working Voltage (V)	350~500
	tan δ (max.)	0.2
Low Temperature Characteristics	Impedance ratio max. at 120Hz	
	Working Voltage (V) Z-25°C / Z+20°C	350~500 8
High Temperature Loading	Test time : 10,000 hours Test temperature : +85°C Test conditions : Rated DC working voltage with rated ripple current	Post test requirements at +20°C Leakage current : ≤ Initial specified value Cap. change : within ±20% of the initial measured tan δ : value ≤ 300% of the initial specified value
	Shelf Life	At +85°C no voltage applied after 1,000 hours and then being stabilized at +20°C the capacitors shall meet the following limits Leakage current : ≤ Initial specified value Cap. change : within ±20% of the initial measured value tan δ : ≤ 300% of the initial specified value
Industrial Standard	JIS C - 5101-4 (IEC 60384-4)	

RIPPLE CURRENT MULTIPLIER

Frequency Coefficient

Coefficient Rated Voltage	Freq. (Hz)	Frequency Coefficient				
		50	120	300	1k	10k~
<160V		0.80	1.00	1.08	1.15	1.15
≥160V		0.80	1.00	1.08	1.15	1.20

PART NUMBER SYSTEM (EXAMPLE : 400V 3300µF)

1	2 3	4 5 6	7	8 9	10	11 12	13 14
E	WH	338	M	2G	U	90	OO

Type (Terminal Code)
 Case Length (90mm)
 Diameter (76.2mm)
 Voltage (400V)
 Tolerance (±20%)
 Capacitance (3300µF)
 Series
 E-CAP

CASE SIZE TABLE



Dimensions of mounting bracket

Voltage (Code)		3 - Leg				2 - Leg			
Symbol	ϕD	51	63.5	76	90	51	63.5	76	90
P		32.5	38.1	44.5	50.8	33.2	40.5	46.5	53
A		38.5	43	49.2	58.5	40	46.5	53	59
T		7.5	8.0	7.0	8.0	6.0	7.0	6.0	6.0
S		5.0	5.0	5.0	5.0	4.5	4.5	4.5	4.5
U		12	14	14	18	14	14	14	14
θ°		60	60	60	60	30	30	30	30
H		20	25	30	35	25	35	35	35
h		15	20	24	25	15	20	20	20

STANDARD RATINGS

Voltage (Code)		350V (2V)		400V (2G)		450V (2W)		500V (2H)	
SV		400		450		500		550	
Cap. (µF)	Code	Case Size	Ripple Current	Case Size	Ripple Current	Case Size	Ripple Current	Case Size	Ripple Current
470	477							51 x 80	2.4
560	567					51 x 80	2.6		
680	687			51 x 80	3.0				
820	827	51 x 80	3.3					51 x 90	3.6
1000	108					51 x 90	4.0	51 x 110	4.4
1200	128			51 x 90	4.7	51 x 110	4.8	51 x 130	5.2
1500	158	51 x 90	5.2					63.5 x 90	5.0
1800	188							51 x 150	6.3
				51 x 110	6.3	51 x 130	6.4	63.5 x 110	6.8
						63.5 x 90	6.2		
2200	228	51 x 110	7.0	51 x 130	7.5	51 x 150	7.6		
				63.5 x 90	7.3	63.5 x 110	7.5		
		51 x 130	8.4	51 x 150	8.9	63.5 x 130	8.9	63.5 x 150	9.6
2700	278	63.5 x 90	8.1	63.5 x 110	8.8	76 x 90	8.4	76 x 110	9.2
3300	338	51 x 150	9.9	63.5 x 130	10.5	63.5 x 150	10.6		
				76 x 90	9.9	76 x 110	10.2		
3900	398	63.5 x 130	11.5					76 x 150	12.7
		76 x 90	10.8			76 x 130	11.9	90 x 130	11.9
4700	478			63.5 x 150	13.4	76 x 115	12.4		
				76 x 130	13.9	76 x 150	14.0		
5600	568	63.5 x 150	14.7			90 x 130	14.2		
6800	688	76 x 130	16.8	76 x 150	17.9	76 x 190	17.3	90 x 190	18.8
				90 x 130	17.2	90 x 150	16.7		
8200	828	76 x 150	19.6	76 x 190	20.8				
				90 x 150	20.1				
10000	109	76 x 190	23.0			90 x 190	22.8	90 x 270	26.8
12000	129			90 x 190	27.4				
15000	159	90 x 190	30.6			90 x 270	32.8		
22000	229	90 x 270	43.5	90 x 270	39.4				

Maximum Allowable Ripple Current (Arms) at 85°C 120Hz

Case Size Φ D x L (mm)

Specifications are subject to change without notice. Should a safety or technical concern arise regarding the product, please be sure to contact our sales offices or agents immediately.

FEATURES

- Load life of 20,000 hours application of ripple current at 85°C.
- High ripple, high reliability.
- Best for use in industrial power supplies for inverter circuitry.



SPECIFICATIONS

Item	Performance Characteristics	
Operating Temperature Range	-25 to +85°C	
Rated Working Voltage Range	350 to 450V	
Nominal Capacitance Range	2200 to 12000µF	
Capacitance Tolerance	±20% at 120Hz, +20°C	
Leakage Current	I ≤ 0.02CV (µA) or 5 (mA) whichever is smaller measured after 5 minutes application of rated working voltage at +20°C	
tan δ (120Hz, +20°C)	Working Voltage (V)	350~450
	tan δ (max.)	0.25
Low Temperature Characteristics	Impedance ratio max. at 120Hz	
	Working Voltage (V) Z-25°C / Z+20°C	350~450 8
High Temperature Loading	Test time : 20,000 hours Test temperature : +85°C Test conditions : Rated DC working voltage with rated ripple current	Post test requirements at +20°C Leakage current : ≤ Initial specified value Cap. change : within ±30% of the initial measured value tan δ : ≤ 300% of the initial specified value
	Shelf Life	At +85°C no voltage applied after 1,000 hours and then being stabilized at +20°C the capacitors shall meet the following limits Leakage current : ≤ Initial specified value Cap. change : within ±20% of the initial measured value tan δ : ≤ 200% of the initial specified value
Industrial Standard	JIS C - 5101-4 (IEC 60384-4)	

RIPPLE CURRENT MULTIPLIER

Frequency Coefficient

Coefficient Rated Voltage	Freq. (Hz)					
	50	120	300	1k	10k~	
< 160V	0.80	1.00	1.08	1.15	1.15	
≥ 160V	0.80	1.00	1.08	1.15	1.20	

PART NUMBER SYSTEM (EXAMPLE : 350V 4700µF)

1	2 3	4 5 6	7	8 9	10	11 12	13 14
E	WL	478	M	2V	U	1N	OO

Type (Terminal Code)
 Case Length (120mm)
 Diameter (76.2mm)
 Voltage (350V)
 Tolerance (±20%)
 Capacitance (4700µF)
 Series
 E-CAP

CASE SIZE TABLE



Dimensions of mounting bracket

Voltage (Code)		3 - Leg			2 - Leg		
Symbol	ϕD	63.5	76	90	63.5	76	90
P		38.1	44.5	50.8	40.5	46.5	53
A		43	49.2	58.5	46.5	53	59
T		8.0	7.0	8.0	7.0	6.0	6.0
S		5.0	5.0	5.0	4.5	4.5	4.5
U		14	14	18	14	14	14
θ°		60	60	60	30	30	30
H		25	30	35	35	35	35
h		20	24	25	20	20	20

STANDARD RATINGS

Voltage (Code)		350V (2V)		400V (2G)		450V (2W)	
SV		400		450		500	
Cap. (μF)	Code	Case Size	Ripple Current	Case Size	Ripple Current	Case Size	Ripple Current
2200	228					63.5 x 120	9.1
2700	278			63.5 x 120	10.1	63.5 x 130	10.6
						76 x 120	11.2
3300	338	63.5 x 120	11.1	63.5 x 130	11.7	63.5 x 160	12.7
						76 x 130	13.0
3900	398	63.5 x 130	12.8	63.5 x 160	13.8	63.5 x 170	14.4
				76 x 120	14.7		
4700	478	63.5 x 160	15.2	63.5 x 170	15.8	76 x 160	16.7
		76 x 120	14.7	76 x 130	15.5		
5600	568	63.5 x 170	17.3	63.5 x 190	18.2	76 x 190	20.1
		76 x 130	16.9	76 x 160	18.3	90 x 160	19.9
6800	688	63.5 x 190	20.0	76 x 170	21.0	90 x 170	23.0
		76 x 160	20.2				
8200	828	76 x 170	23.1	90 x 160	24.1	90 x 190	26.4
10000	109	90 x 160	26.6	90 x 190	29.1	90 x 190	29.1
12000	129	90 x 190	32.0				

Maximum Allowable Ripple Current (Arms) at 85°C 120Hz

Case Size Φ D x L (mm)

FEATURES

- +125°C, high temperature.
- High reliability equipment in automotive power electronics, e.g. integrated starter alternator.



SPECIFICATIONS

Item	Performance Characteristics			
Operating Temperature Range	-25 to +125°C			
Rated Working Voltage Range	160 to 400V			
Nominal Capacitance Range	330 to 15000μF			
Capacitance Tolerance	±20% at 120Hz, +20°C			
Leakage Current	I ≤ 0.02CV (μA) or 5 (mA) whichever is smaller measured after 5 minutes application of rated working voltage at +20°C			
tan δ (120Hz, +20°C)	The values shown in the STANDARD RATINGS tables			
Low Temperature Characteristics	Impedance ratio max. at 120Hz			
	<table border="1"> <tr> <td>Working Voltage (V)</td> <td>160~400</td> </tr> <tr> <td>Z-25°C / Z+20°C</td> <td>8</td> </tr> </table>	Working Voltage (V)	160~400	Z-25°C / Z+20°C
Working Voltage (V)	160~400			
Z-25°C / Z+20°C	8			
High Temperature Loading	Test time : 3,000 hours	Post test requirements at +20°C		
	Test temperature : +125°C	Leakage current : ≤ Initial specified value		
	Test conditions : Rated DC working voltage with rated ripple current	Cap. change : within ±30% of the initial measured value		
		tan δ : ≤ 300% of the initial specified value		
Shelf Life	At +125°C no voltage applied after 1,000 hours and then being stabilized at +20°C the capacitors shall meet the following limits			
	Leakage current	: ≤ Initial specified value		
	Cap. change	: within ±20% of the initial measured value		
	tan δ	: ≤ 200% of the initial specified value		
Industrial Standard	JIS C - 5101-4 (IEC 60384-4)			

RIPPLE CURRENT MULTIPLIER

Frequency Coefficient

Coefficient Rated Voltage	Freq. (Hz)				
	50	120	300	1k	10k~
<160V	0.80	1.00	1.08	1.15	1.15
≥160V	0.80	1.00	1.08	1.15	1.20

PART NUMBER SYSTEM (EXAMPLE : 200V 1000μF)

1	23	456	7	89	10	1112	1314	
E	WB	108	M	2D	Q	80	OO	
								Type (Terminal Code)
								Case Length (80mm)
								Diameter (35mm)
								Voltage (200V)
								Tolerance (±20%)
								Capacitance (1000μF)
								Series
								E-CAP

CASE SIZE TABLE



Dimensions of mounting bracket

Voltage (Code)		3 - Leg				2 - Leg				
Symbol	ϕD	51	63.5	76	90	35	51	63.5	76	90
P		32.5	38.1	44.5	50.8	24	33.2	40.5	46.5	53
A		38.5	43	49.2	58.5	29	40	46.5	53	59
T		7.5	8.0	7.0	8.0	6.0	6.0	7.0	6.0	6.0
S		5.0	5.0	5.0	5.0	3.5	4.5	4.5	4.5	4.5
U		12	14	14	18	10	14	14	14	14
θ°		60	60	60	60	30	30	30	30	30
H		20	25	30	35	15	25	35	35	35
h		15	20	24	25	10	15	20	20	20

STANDARD RATINGS

Voltage (Code)		160V (2C)			200V (2D)			250V (2E)		
SV		200			250			300		
Cap. (μF)	Code	Case Size	tan δ	Ripple Current	Case Size	tan δ	Ripple Current	Case Size	tan δ	Ripple Current
330	337							35 x 50	0.15	0.7
390	397							35 x 80	0.15	0.8
470	477				35 x 50	0.15	0.9	35 x 80	0.15	0.9
560	567				35 x 80	0.15	1.0	35 x 80	0.15	1.0
680	687	35 x 50	0.15	1.1	35 x 80	0.15	1.1	35 x 100	0.15	1.2
820	827	35 x 80	0.15	1.2	35 x 80	0.15	1.3	35 x 100	0.15	1.4
1000	108	35 x 80	0.15	1.3	35 x 80	0.15	1.5	35 x 120	0.15	1.6
1200	128	35 x 80	0.15	1.5	35 x 100	0.15	1.7	51 x 80	0.15	1.8
1500	158	35 x 80	0.15	1.7	35 x 120	0.15	1.9	51 x 100	0.15	2.2
1800	188	35 x 100	0.15	2.0	35 x 120	0.15	2.2	51 x 120	0.15	2.6
2200	228	35 x 120	0.15	2.3	51 x 80	0.15	2.7	51 x 120	0.15	2.8
2700	278	35 x 120	0.15	2.7	51 x 100	0.15	3.2	63.5 x 100	0.15	3.3
3300	338	51 x 100	0.15	3.3	51 x 120	0.15	3.5	63.5 x 120	0.15	4.0
3900	398	51 x 120	0.15	3.8	63.5 x 100	0.15	4.0	76 x 100	0.15	4.4
4700	478	51 x 120	0.15	4.2	63.5 x 120	0.15	4.7	76 x 120	0.15	5.2
5600	568	51 x 120	0.15	4.7	76 x 100	0.15	5.3	76 x 140	0.15	6.1
6800	688	63.5 x 120	0.15	5.7	76 x 120	0.15	6.3	90 x 140	0.15	7.4
8200	828	76 x 100	0.20	6.4	76 x 140	0.20	6.4			
10000	109	76 x 120	0.20	6.6	90 x 140	0.20	7.7			
12000	129	76 x 140	0.20	7.8						
15000	159	90 x 140	0.20	9.5						

Maximum Allowable Ripple Current (Arms) at 125°C 120Hz
tan δ at 20°C 120Hz

Case Size ΦD x L (mm)

Voltage (Code)		350V (2V)			400V (2G)		
SV		400			450		
Cap. (μF)	Code	Case Size	tan δ	Ripple Current	Case Size	tan δ	Ripple Current
680	687				51 x 80	0.25	3.0
820	827	51 x 80	0.25	3.3			
1200	128				51 x 100	0.25	4.7
1500	158	51 x 100	0.25	5.2			
1800	188				63.5 x 90	0.25	6.3
2200	228	63.5 x 90	0.25	7.0	63.5 x 110	0.25	7.5
2700	278	63.5 x 110	0.25	8.4	63.5 x 120	0.25	8.8
3300	338	63.5 x 120	0.25	9.9	63.5 x 140	0.25	10.5
					76 x 110	0.25	9.9
3900	398	63.5 x 140	0.25	11.5			
		76 x 110	0.25	10.8			
4700	478				63.5 x 150	0.25	13.4
5600	568	76 x 150	0.25	14.7			
6800	688	76 x 170	0.25	16.8	76 x 190	0.25	17.9
					90 x 160	0.25	17.2
8200	828	76 x 190	0.25	19.6	90 x 190	0.25	20.1
10000	109	90 x 190	0.25	23.0			

Maximum Allowable Ripple Current (Arms) at 125°C 120Hz
tan δ at 20°C 120Hz

Case Size ΦD x L (mm)

Specifications are subject to change without notice. Should a safety or technical concern arise regarding the product, please be sure to contact our sales offices or agents immediately.

PACKAGING SPECIFICATIONS

	Specifications		Quantity				
	$\phi 4 \times 5.4$ $\phi 5 \sim 6.3 \times 5.4 \sim 7.7$ $\phi 8 \times 6.2$ $\phi 8 \sim 10 \times 10.2$ $\phi 12.5 \times 13.5$ $\phi 12.5 \times 16$ $\phi 16 \times 16.5$ $\phi 16 \times 21.5$	2,000 pcs 1,000 pcs 1,000 pcs 500 pcs 200 pcs 150 pcs 125 pcs 75 pcs					
ϕD	4	5	6.3	8	10	12	16
A	14	14	18	26	26	34	46

TAPING DIMENSIONS



Specifications	W ± 0.30	A	B	P ₁ ± 0.10	F ± 0.10	t ₂
$\phi 4 \times 5.4$	12.0	4.7	4.7	8.0	5.5	5.8
$\phi 5 \times 5.4$	12.0	6.0	6.0	12.0	5.5	5.8
$\phi 6.3 \times 5.4$	16.0	7.0	7.0	12.0	7.5	5.8
$\phi 6.3 \times 7.7$	16.0	7.0	7.0	12.0	7.5	8.3
$\phi 8 \times 6.2$	16.0	8.7	8.7	12.0	7.5	6.8
$\phi 8 \times 10.2$	24.0	8.7	8.7	16.0	11.5	11.0
$\phi 10 \times 10.2$	24.0	10.7	10.7	16.0	11.5	11.0
$\phi 12.5 \times 13.5$	32.0	13.4	13.4	24	14.2	14.4
$\phi 12.5 \times 16$	32.0	13.4	13.4	24	14.2	16.3
$\phi 16 \times 16.5$	44.0	17.5	17.5	28	20.2	17.4
$\phi 16 \times 21.2$	44.0	17.5	17.5	28	20.2	22.4

REFLOW SOLDERING FOR CHIP CAPACITORS



ALLOWABLE RANGE OF PEAK TEMPERATURE

Size	T (°C)	t (second)	t ₁ (second)
$\phi 4 \phi 6.3$	255	100	50
$\phi 8$	245	100	40
$\phi 10 \phi 16$	245	100	40

RECOMMENDED LAND SIZE

Size	mm		
	X	Y	a
$\phi 4$	1.6	2.6	1.0
$\phi 5$	1.6	3.0	1.4
$\phi 6.3$	1.6	3.5	2.1
$\phi 8$	2.5	3.5	3.0
$\phi 10$	2.5	4.0	4.5
$\phi 12.5$	2.5	6.0	5.0
$\phi 16$	3.0	6.5	8.0

- Preheat shall be done 100°C-200°C and for maximum 180 seconds.
- The temperature at capacitor top shall not exceed +255°C.
- The duration for over +200°C temperature at capacitor top shall not exceed 110 seconds.
- If capacitors are subject to the conditions other than the allowable range of reflow. Please contact us.

FEATURES

- Reflow soldering is available
- Available for high density surface mounting
- High stability and reliability
- Life time: 85°C, 2,000Hrs



SPECIFICATIONS

Item	Performance Characteristics						
Operating Temperature Range	-40 to +85°C						
Rated Working Voltage Range	6.3 to 50V						
Nominal Capacitance Range	0.1 to 1500μF						
Capacitance Tolerance	±20% at 120Hz, +20°C						
Leakage Current	I ≤ 0.01CV or 3(μA) whichever is greater measure after 2 minutes application of rated working voltage at +20°C						
tanδ (120Hz, +20°C)	Working Voltage (V)	6.3	10	16	25	35	50
	tanδ (max.) φ4-6.3	0.26	0.22	0.18	0.16	0.13	0.12
	φ8-10	0.35	0.26	0.20	0.16	0.14	0.12
Low Temperature Characteristics	Impedance ratio max. at 120Hz						
	Working Voltage (V)	6.3	10	16	25	35	50
	Z-40°C / Z+20°C	8	8	4	4	3	3
High Temperature Loading	Test time	: 2,000 hours			Post test requirements at +20°C		
	Test temperature	: +85°C			Leakage current : ≤ Initial specified value		
	Test conditions	: Rated DC working voltage			Cap. change : within ±20% of the initial measured value		
					tanδ : ≤ 200% of the initial specified value		
Shelf Life	At +85°C no voltage applied after 1,000 hours and then being stabilized at +20°C the capacitors shall meet the following limits						
	Leakage current	: ≤ 200% of initial specified value					
	Cap. change	: within ±20% of the initial measured value					
	tanδ	: ≤ 200% of the initial specified value					
Industrial Standard	JIS C - 5101-4 (IEC 60384-4)						

DIMENSIONS & MARKING

Size	φ4 x 5.4	φ5 x 5.4	φ6.3 x 5.4	φ6.3 x 7.7	φ8 x 10.2	φ10 x 10.2
A	1.8	2.1	2.4	2.5	2.9	3.2
B	4.3	5.3	6.6	6.6	8.3	10.3
C	4.3	5.3	6.6	6.6	8.3	10.3
E	1.0	1.3	2.2	2.2	3.1	4.5
L	5.4	5.4	5.4	7.7	10.2	10.2
H	0.5 - 0.9				0.9 - 1.1	

(φ4 ~ φ6.3)

(φ6.3 x 7.7)

(φ8 ~ φ10 x 10.2)

PART NUMBER SYSTEM (EXAMPLE: 16V 470µF)



STANDARD RATINGS

Voltage (Code)		6.3V (0J)		10V (1A)		16V (1C)		25V (1E)	
Cap. (µF)	Code	Case Size	Ripple Current	Case Size	Ripple Current	Case Size	Ripple Current	Case Size	Ripple Current
4.7	475							4 x 5.4	16
10	106					4 x 5.4	23	4 x 5.4	24
22	226	4 x 5.4	28	4 x 5.4	30	5 x 5.4	37	5 x 5.4	38
33	336	5 x 5.4	37	5 x 5.4	41	5 x 5.4	44	6.3 x 5.4	52
47	476	5 x 5.4	45	6.3 x 5.4	52	5 x 5.4	48	6.3 x 5.4	60
						6.3 x 5.4	58		
100	107	5 x 5.4	50	6.3 x 5.4	76	6.3 x 5.4	86	6.3 x 7.7	130
		6.3 x 5.4	70						
220	227	6.3 x 5.4	95	6.3 x 7.7	150	6.3 x 7.7	150	8 x 10.2	232
330	337	6.3 x 7.7	150	8 x 10.2	240	8 x 10.2	270	10 x 10.2	305
470	477	8 x 10.2	265	8 x 10.2	290	8 x 10.2	280	10 x 10.2	393
						10 x 10.2	330		
1000	108	10 x 10.2	400	10 x 10.2	454				
1500	158	10 x 10.2	489						

Maximum Allowable Ripple Current (mA rms) at 85°C 120Hz

Case Size Φ D x L (mm)

Voltage (Code)		35V (1V)		50V (1H)	
Cap. (µF)	Code	Case Size	Ripple Current	Case Size	Ripple Current
0.1	104			4 x 5.4	1.0
0.22	224			4 x 5.4	2.0
0.33	334			4 x 5.4	2.8
0.47	474			4 x 5.4	4.0
1	105			4 x 5.4	8.4
2.2	225			4 x 5.4	13
3.3	335	4 x 5.4	18	4 x 5.4	17
4.7	475	4 x 5.4	20	5 x 5.4	20
10	106	5 x 5.4	29	6.3 x 5.4	33
22	226	6.3 x 5.4	46	6.3 x 5.4	43
33	336	6.3 x 5.4	53	6.3 x 7.7	85
47	476	6.3 x 5.4	55	6.3 x 7.7	90
		6.3 x 7.7	70	8 x 10.2	140
100	107	6.3 x 7.7	80	8 x 10.2	145
		8 x 10.2	175	10 x 10.2	195
220	227	8 x 10.2	185	10 x 10.2	415
		10 x 10.2	265		
330	337	10 x 10.2	324		
470	477	10 x 10.2	395		

Maximum Allowable Ripple Current (mA rms) at 85°C 120Hz

Case Size Φ D x L (mm)

Specifications are subject to change without notice. Should a safety or technical concern arise regarding the product, please be sure to contact our sales offices or agents immediately.

FEATURES

- Operating over wide temperature range
- Reflow soldering is available
- Available for high density surface mounting
- High stability and reliability



SPECIFICATIONS

Item	Performance Characteristics						
Operating Temperature Range	-55 to +105°C						
Rated Working Voltage Range	6.3 to 50V						
Nominal Capacitance Range	0.1 to 220μF						
Capacitance Tolerance	±20% at 120Hz, +20°C						
Leakage Current	$I \leq 0.01CV$ or $3(\mu A)$ whichever is greater measure after 2 minutes application of rated working voltage at +20°C						
tan δ (120Hz, +20°C)	Working Voltage (V)	6.3	10	16	25	35	50
	tanδ	0.26	0.20	0.16	0.14	0.12	0.12
Low Temperature Characteristics	Impedance ratio max. at 120Hz						
	Working Voltage (V)	6.3	10	16	25	35	50
	Z-25°C / Z+20°C	4	3	2	2	2	2
High Temperature Loading	Test time : 1,000 hours	Post test requirements at +20°C					
	Test temperature : +105°C	Leakage current : ≤Initial specified value					
Shelf Life	Test conditions : Rated DC working voltage	Cap. change : within ±20% of the initial measured value					
		tan δ : ≤200% of the initial specified value					
Industrial Standard	At +105°C no voltage applied after 1,000 hours and then being stabilized at +20°C the capacitors shall meet the following limits Leakage current : ≤200% of the initial specified value Cap. change : within ±20% of the initial measured value tanδ : ≤200% of the initial specified value JIS C - 5101-4 (IEC 60384-4)						

DIMENSIONS & MARKING



Size	Φ4 x 5.4	Φ5 x 5.4	Φ6.3 x 5.4
A	1.8	2.1	2.4
B	4.3	5.3	6.6
C	4.3	5.3	6.6
E	1.0	1.3	2.2
L	5.4	5.4	5.4
H	0.5 ~ 0.9		

PART NUMBER SYSTEM (EXAMPLE: 16V 100μF)

1	23	456	7	89	10	11 12	13 14
V	T1	107	M	1C	E	54	TR



STANDARD RATINGS

Voltage (Code)		6.3V (0J)		10V (1A)		16V (1C)		25V (1E)	
Cap. (μF)	Code	Case Size	Ripple Current	Case Size	Ripple Current	Case Size	Ripple Current	Case Size	Ripple Current
4.7	475					4 x 5.4	12	4 x 5.4	13
10	106					4 x 5.4	20	4 x 5.4	14
						5 x 5.4	20	5 x 5.4	20
22	226	4 x 5.4	20	4 x 5.4	21	4 x 5.4	22	5 x 5.4	25
				5 x 5.4	27	5 x 5.4	31	6.3 x 5.4	36
33	336	4 x 5.4	22	4 x 5.4	23	5 x 5.4	28	5 x 5.4	29
		5 x 5.4	27	5 x 5.4	34	6.3 x 5.4	40	6.3 x 5.4	44
47	476	4 x 5.4	25	5 x 5.4	30	5 x 5.4	31	6.3 x 5.4	48
		5 x 5.4	37	6.3 x 5.4	41	6.3 x 5.4	56		
100	107	5 x 5.4	39	6.3 x 5.4	53	6.3 x 5.4	75		
		6.3 x 5.4	57						
220	227	6.3 x 5.4	67						

Maximum Allowable Ripple Current (mA rms) at 105°C 120Hz

Case Size ΦD x L (mm)

Voltage (Code)		35V (1V)		50V (1H)	
Cap. (μF)	Code	Case Size	Ripple Current	Case Size	Ripple Current
0.1	104			4 x 5.4	1.0
0.22	224			4 x 5.4	2.0
0.33	334			4 x 5.4	3.0
0.47	474			4 x 5.4	4.0
1	105			4 x 5.4	8.0
2.2	225			4 x 5.4	11
3.3	335			4 x 5.4	13
4.7	475	4 x 5.4	14	5 x 5.4	18
10	106	5 x 5.4	24	6.3 x 5.4	28
		5 x 5.4	27		
22	226	6.3 x 5.4	40	6.3 x 5.4	42
		6.3 x 5.4	50		

Maximum Allowable Ripple Current (mArms) at 105°C 120Hz

Case Size ΦD x L (mm)

Specifications are subject to change without notice. Should a safety or technical concern arise regarding the product, please be sure to contact our sales offices or agents immediately.

FEATURES

- Life time: 105°C, 2,000Hrs
- Reflow soldering is available
- Available for high density surface mounting
- High stability and reliability



SPECIFICATIONS

Item	Performance Characteristics								
Operating Temperature Range	-55 to +105°C								
Rated Working Voltage Range	6.3 to 100V								
Nominal Capacitance Range	4.7 to 1500μF								
Capacitance Tolerance	±20% at 120Hz, +20°C								
Leakage Current	I ≤ 0.01CV or 3(μA) whichever is greater measure after 2 minutes application of rated working voltage at +20°C								
tanδ (120Hz, +20°C)	Working Voltage (V)	6.3	10	16	25	35	50	63	100
	tanδ (max.)	0.26	0.20	0.16	0.14	0.12	0.12	0.12	0.12
Low Temperature Characteristics	Impedance ratio max. at 120Hz								
	Working Voltage (V)	6.3	10	16	25	35	50	63	100
	Z-25°C / Z+20°C	4	3	2	2	2	2	3	3
	Z-40°C / Z+20°C	8	6	4	4	3	3	4	4
High Temperature Loading	Test time : 2,000 hours	Post test requirements at +20°C							
	Test temperature : +105°C Test conditions : Rated DC working voltage	Leakage current : ≤ Initial specified value Cap. change : within ±20% of the initial measured value (≤16V: within ±25%) tanδ : ≤200% of the initial specified value							
Shelf Life	At +105°C no voltage applied after 1,000 hours and then being stabilized at +20°C the capacitors shall meet the following limits Leakage current : ≤ Initial specified value Cap. change : within ±20% of the initial measured value tanδ : ≤200% of the initial specified value								
Industrial Standard	JIS C - 5101-4 (IEC 60384-4)								

DIMENSIONS & MARKING

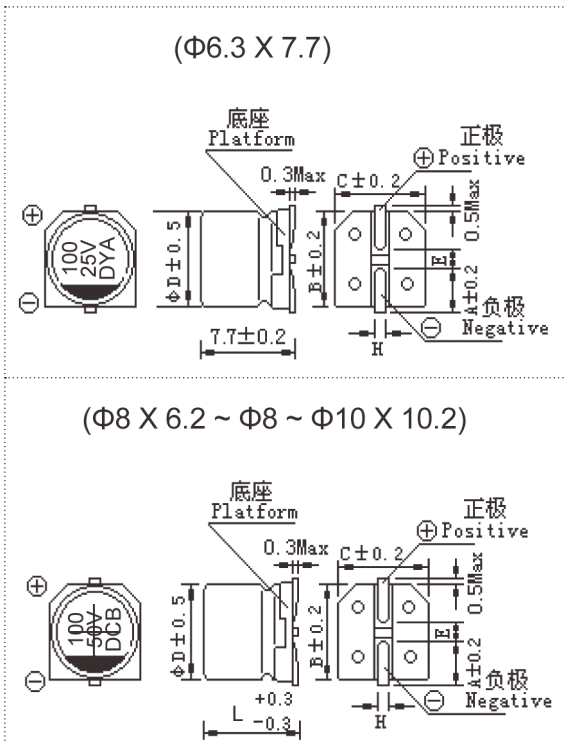

Size	Φ6.3 x 7.7	Φ8 x 6.2	Φ8 x 10.2	Φ10 x 10.2
A	2.5	2.9	2.9	3.2
B	6.6	8.3	8.3	10.3
C	6.6	8.3	8.3	10.3
E	2.2	3.1	3.1	4.5
L	7.7	6.2	10.2	10.2
H	0.5 ~ 0.9		0.8 ~ 1.1	

PART NUMBER SYSTEM (EXAMPLE: 25V 470µF)



STANDARD RATINGS

Voltage (Code)		6.3V (0J)		10V (1A)		16V (1C)		25V (1E)	
Cap. (µF)	Code	Case Size	Ripple Current	Case Size	Ripple Current	Case Size	Ripple Current	Case Size	Ripple Current
100	107							6.3 x 7.7	91
								8 x 6.2	105
220	227	6.3 x 7.7	105	6.3 x 7.7	110	6.3 x 7.7	105	8 x 10.2	175
		8 x 6.2	115	8 x 6.2	120	8 x 6.2	125		
330	337	6.3 x 7.7	110	8 x 10.2	196	8 x 10.2	195	10 x 10.2	240
		8 x 6.2	120					8 x 10.2	220
470	477	8 x 10.2	210	8 x 10.2	210	10 x 10.2	295	10 x 10.2	280
						8 x 10.2	230		
1000	108	10 x 10.2	300	10 x 10.2	315	10 x 10.2	340		
		8 x 10.2	230						
1500	158	10 x 10.2	315	10 x 12	350				

Maximum Allowable Ripple Current (mA rms) at 105°C 120Hz

Case Size Φ D x L (mm)

Voltage (Code)		35V (1V)		50V (1H)		63V (1J)		100V (2A)	
Cap. (µF)	Code	Case Size	Ripple Current	Case Size	Ripple Current	Case Size	Ripple Current	Case Size	Ripple Current
4.7	475							6.3 x 7.7	35
								8 x 6.2	40
10	106					6.3 x 7.7	39	8 x 10.2	77
						8 x 6.2	45	6.3 x 7.7	35
22	226			6.3 x 7.7	51	6.3 x 7.7	48	10 x 10.2	126
				8 x 6.2	54			8 x 10.2	84
33	336	8 x 6.2	50	6.3 x 7.7	60	8 x 10.2	98	10 x 10.2	133
						6.3 x 7.7	49		
47	476	6.3 x 7.7	70	8 x 10.2	120	10 x 10.2	160	10 x 10.2	140
		8 x 6.2	78	6.3 x 7.7	75	8 x 10.2	119		
100	107	8 x 10.2	120	10 x 10.2	170	10 x 10.2	196		
		6.3 x 7.7	84	8 x 10.2	140				
220	227	10 x 10.2	220	10 x 10.2	220				
		8 x 10.2	190						
330	337	10 x 10.2	245						
470	477	10 x 12	280						

Maximum Allowable Ripple Current (mA rms) at 105°C 120Hz

Case Size Φ D x L (mm)

Specifications are subject to change without notice. Should a safety or technical concern arise regarding the product, please be sure to contact our sales offices or agents immediately.

FEATURES

- Life time: 105°C, 3,000Hrs
- Small size, large capacity
- High stability and reliability with high ripple current



SPECIFICATIONS

Item	Performance Characteristics	
Operating Temperature Range	-25 to +105°C	
Rated Working Voltage Range	400V.DC	
Nominal Capacitance Range	2.2 ~ 4.7μF	
Capacitance Tolerance	±20% at 120Hz, +20°C	
Leakage Current	I ≤ 0.04CV + 100(μA) after 1 minute application of rated working voltage at +20°C	
tanδ (120Hz, +20°C)	Working Voltage (V)	400
	tanδ	0.22
Low Temperature Characteristics	Impedance ratio max. at 120Hz	
	Z-25°C / Z+20°C	6
High Temperature Loading	Test time : 3,000 hours	Post test requirements at +20°C
	Test temperature : +105°C	Leakage current : ≤ Initial specified value
Shelf Life	Test conditions : Rated DC working voltage	Cap. change : within ±20% of the initial measured value
		tan δ : ≤ 200% of the initial specified value
Industrial Standard	At +105°C no voltage applied after 1,000 hours and then being stabilized at +20°C the capacitors shall meet the following limits	
	Leakage current : ≤ 200% of initial specified value	Cap. change : within ±20% of the initial measured value
	tanδ : ≤ 200% of the initial specified value	

DIMENSIONS & MARKING



Size	Φ8 x 10.2	Φ10 x 10.2
A	2.9	3.2
B	8.3	10.3
C	8.3	10.3
E	3.1	4.5
L	10.2	10.2
H	0.8 ~ 1.1	

PART NUMBER SYSTEM (EXAMPLE: 400V 2.2μF)

1	23	456	7	89	10	11 12	13 14
V	TG	225	M	2G	F	T2	TR



STANDARD RATINGS

Voltage (Code)		400V (2G)	
Cap. (μF)	Code	Case Size	Ripple Current
2.2	225	8 x 10.2	26
3.3	335	10 x 10.2	37
4.7	475	10 x 10.2	39

Maximum Allowable Ripple Current (mA rms) at 105°C 120Hz

Case Size Φ D x L (mm)

FEATURES

- Life time: 105°C, 2,000Hrs
- Reflow soldering is available
- Available for high density surface mounting
- High stability and reliability
- Low impedance



SPECIFICATIONS

Item	Performance Characteristics										
Operating Temperature Range	-55 to +105°C										
Rated Working Voltage Range	6.3 to 100V										
Nominal Capacitance Range	1 to 1500μF										
Capacitance Tolerance	±20% at 120Hz, +20°C										
Leakage Current	I ≤ 0.01CV or 3(μA) whichever is greater measure after 2 minutes application of rated working voltage at +20°C										
tanδ (120Hz, +20°C)	Working Voltage (V)	6.3	10	16	25	35	50	63	80	100	
	tanδ (max.)	0.22	0.19	0.16	0.14	0.12	0.10	0.08	0.08	0.08	
Low Temperature Characteristics	Impedance ratio max. at 120Hz										
	Working Voltage (V)	6.3	10	16	25	35	50	63	80	100	
	Z-25°C / Z+20°C	2	2	2	2	2	2	2	2	2	
	Z-40°C / Z+20°C	3	3	3	3	3	3	3	3	3	
High Temperature Loading	Test time	: 2,000 hours				Post test requirements at +20°C					
	Test temperature	: +105°C				Leakage current : ≤ Initial specified value					
Shelf Life	Test conditions	: Rated DC working voltage				Cap. change : within ±20% of the initial measured value (≤16V: within ±25%)					
						tanδ : ≤200% of the initial specified value					
Industrial Standard	At +105°C no voltage applied after 1,000 hours and then being stabilized at +20°C the capacitors shall meet the following limits Leakage current : ≤200% of initial specified value Cap. change : within ±20% of the initial measured value tanδ : ≤120% of the initial specified value										
	JIS C - 5101-4 (IEC 60384-4)										

DIMENSIONS & MARKING



Size	Φ4x5.4	Φ5x5.4	Φ6.3x5.4	Φ6.3x7.7	Φ8x6.2	Φ8x10.2	Φ10x10.2
A	1.8	2.2	2.6	2.6	2.9	2.9	3.3
B	4.3	5.3	6.6	6.6	8.3	8.3	10.3
C	4.3	5.3	6.6	6.6	8.3	8.3	10.3
L	5.4	5.4	5.4	7.7	6.2	10.2	10.2
H	0.5 - 0.9				0.9 - 1.1		

PART NUMBER SYSTEM (EXAMPLE: 25V 470µF)

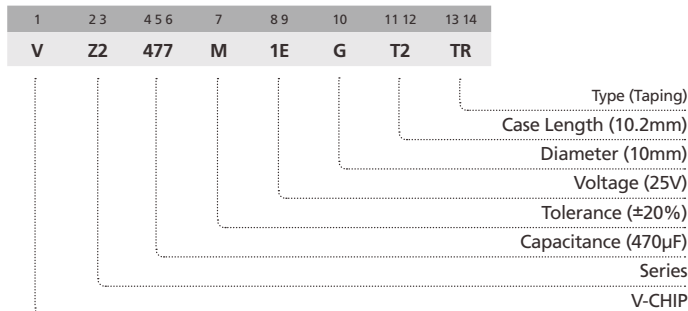

STANDARD RATINGS

Voltage (Code)		6.3V (0J)			10V (1A)			16V (1C)			25V (1E)			35V (1V)		
Cap. (µF)	Code	Case Size	Impedance	Ripple Current	Case Size	Impedance	Ripple Current	Case Size	Impedance	Ripple Current	Case Size	Impedance	Ripple Current	Case Size	Impedance	Ripple Current
4.7	475										4 x 5.4	2.2	80	4 x 5.4	2.2	80
10	106							4 x 5.4	2.2	80	4 x 5.4	2.2	80	5 x 5.4	1.2	150
22	226	4 x 5.4	2.2	80	4 x 5.4	2.2	80	5 x 5.4	1.2	150	6.3 x 5.4	0.58	230	6.3 x 5.4	0.58	230
33	336	5 x 5.4	1.2	150	5 x 5.4	1.2	150	6.3 x 5.4	0.58	230	6.3 x 5.4	0.58	230	6.3 x 5.4	0.58	230
47	476	5 x 5.4	1.2	150	6.3 x 5.4	0.58	230	6.3 x 5.4	0.58	230	6.3 x 7.7	0.34	280	6.3 x 7.7	0.34	280
100	107	6.3 x 5.4	0.58	230	6.3 x 7.7	0.34	280	6.3 x 5.4	0.52	230	6.3 x 7.7	0.34	280	8 x 10.2	0.17	450
		6.3 x 7.7	0.34	280	6.3 x 7.7	0.34	280	6.3 x 7.7	0.34	280	8 x 6.2	0.26	300			
150	157	6.3 x 5.4	0.58	230	6.3 x 7.7	0.34	280	6.3 x 7.7	0.34	280	8 x 10.2	0.17	450	10 x 10.2	0.1	670
220	227	6.3 x 5.4	0.58	243	6.3 x 7.7	0.34	280	6.3 x 7.7	0.34	384	8 x 10.2	0.17	450	8 x 10.2	0.17	587
		6.3 x 7.7	0.34	280				8 x 10.2	0.17	450						
330	337	6.3 x 7.7	0.34	280	8 x 10.2	0.17	450	8 x 10.2	0.17	450	10 x 10.2	0.1	670	10 x 10.2	0.1	670
470	477	8 x 10.2	0.17	450	8 x 10.2	0.17	450	8 x 10.2	0.17	450	10 x 10.2	0.1	670	10 x 10.2	0.1	670
		10 x 10.2	0.1	670				10 x 10.2	0.1	670						
1000	108	8 x 10.2	0.17	450	10 x 10.2	0.1	670	10 x 10.2	0.1	670	10 x 10.2	0.1	670	10 x 10.2	0.1	670
		10 x 10.2	0.1	670												
1500	158	10 x 10.2	0.1	670												

Maximum Allowable Ripple Current (mA rms) at 105°C 100kHz

Case Size Φ D x L (mm)

Maximum ESR (Ω) at 20°C 100kHz

Voltage (Code)		50V (1H)			63V (1J)			80V(1K)			100V (2A)		
Cap. (µF)	Code	Case Size	Impedance	Ripple Current	Case Size	Impedance	Ripple Current	Case Size	Impedance	Ripple Current	Case Size	Impedance	Ripple Current
1	105	4 x 5.4	4.5	60									
2.2	225	4 x 5.4	4.5	60									
3.3	335	4 x 5.4	4.5	60				5 x 5.4	5	25			
4.7	475	5 x 5.4	3.5	85	5 x 5.4	3	50	6.3 x 5.4	3	40			
10	106	6.3 x 5.4	1.8	165	6.3 x 5.4	1.5	80	6.3 x 7.7	2.4	60	8 x 10.2	1.3	130
					6.3 x 7.7	1.2	120						
22	226	6.3 x 7.7	1.6	185	6.3 x 7.7	1.2	120	8 x 10.2	1.3	130	8 x 10.2	1.3	130
33	336	6.3 x 7.7	1.6	185	8 x 10.2	0.65	250	8 x 10.2	1.3	130	10 x 10.2	0.7	200
47	476	8 x 10.2	0.4	300	8 x 10.2	0.65	250	10 x 10.2	0.7	200	10 x 10.2	0.7	200
		10 x 10.2	0.3	342									
68	686	10 x 10.2	0.3	342	8 x 10.2	0.65	250						
100	107	10 x 10.2	0.22	670	10 x 10.2	0.35	400						
150	157	10 x 10.2	0.2	670									
220	227	10 x 10.2	0.18	670									

Maximum Allowable Ripple Current (mA rms) at 105°C 100kHz

Case Size Φ D x L (mm)

Maximum ESR (Ω) at 20°C 100kHz

Specifications are subject to change without notice. Should a safety or technical concern arise regarding the product, please be sure to contact our sales offices or agents immediately.

FEATURES

- Load life of 3,000/5,000 hours at 105°C
- Reflow soldering is available
- Available for high density surface mounting



SPECIFICATIONS

Item	Performance Characteristics							
Operating Temperature Range	-40 to +105°C							
Rated Working Voltage Range	6.3 to 50V							
Nominal Capacitance Range	0.1 to 1000μF							
Capacitance Tolerance	±20% at 120Hz, +20°C							
Leakage Current	I ≤ 0.01CV or 3(μA) whichever is greater measure after 2 minutes application of rated working voltage at +20°C							
tanδ (120Hz, +20°C)	Working Voltage (V)	6.3	10	16	25	35	50	
	tanδ	0.30	0.24	0.20	0.16	0.14	0.14	
Low Temperature Characteristics	Impedance ratio max. at 120Hz							
	Working Voltage (V)	6.3	10	16	25	35	50	
	Z-25°C / Z+20°C	4	3	2	2	2	2	
	Z-40°C / Z+20°C	12	8	6	4	3	3	
High Temperature Loading	Test time	: 3,000 hours (Φ4~6.3); 5,000 hours (Φ8~10)					Post test requirements at +20°C	
	Test temperature	: +105°C					Leakage current : ≤Initial specified value	
	Test conditions	: Rated DC working voltage					Cap. change : within ±30% of the initial measured value	
							tanδ : ≤300% of the initial specified value	
Shelf Life	At +105°C no voltage applied after 1,000 hours and then being stabilized at +20°C the capacitors shall meet the following limits							
	Leakage current	: ≤Initial specified value						
	Cap. change	: within ±30% of the initial measured value						
	tanδ	: ≤300% of the initial specified value						
Industrial Standard	JIS C - 5101-4 (IEC 60384-4)							

DIMENSIONS & MARKING

Size	Φ4 x 6.0	Φ5 x 6.0	Φ6.3 x 6.0	Φ6.3 x 8.0	Φ8 x 10.5	Φ10 x 10.5
A	1.8	2.1	2.4	2.5	2.9	3.2
B	4.3	5.3	6.6	6.6	8.3	10.3
C	4.3	5.3	6.6	6.6	8.3	10.3
D	4.0	5.0	6.3	6.3	8.0	10.0
E	1.0	1.3	2.2	2.2	3.1	4.5
L	6.0	6.0	6.0	8.0	10.5	10.5
H	0.5 ~ 0.9				0.9 ~ 1.1	

(Φ4 ~ Φ6.3 × 6.0)

(Φ6.3 × 8.0)

(Φ8 ~ Φ10 × 10.5)

PART NUMBER SYSTEM (EXAMPLE: 25V 470µF)



STANDARD RATINGS

Voltage (Code)		6.3V (0J)		10V (1A)		16V (1C)		25V (1E)	
Cap. (µF)	Code	Case Size	Ripple Current	Case Size	Ripple Current	Case Size	Ripple Current	Case Size	Ripple Current
4.7	475							4 x 6.0	13
10	106					4 x 6.0	18	4 x 6.0	20
22	226	4 x 6.0	22	4 x 6.0	27	5 x 6.0	30	6.3 x 6.0	34
33	336	5 x 6.0	30	5 x 6.0	35	6.3 x 6.0	40	6.3 x 6.0	50
47	476	5 x 6.0	38	6.3 x 6.0	48	6.3 x 6.0	50	6.3 x 8.0	63
100	107	6.3 x 6.0	69	6.3 x 8.0	80	6.3 x 8.0	81	6.3 x 8.0	90
220	227	6.3 x 8.0	120	6.3 x 8.0	130	8 x 10.5	115	8 x 10.5	170
330	337	6.3 x 8.0	130	8 x 10.5	180	8 x 10.5	195	10 x 10.5	230
470	477	8 x 10.5	210	8 x 10.5	210	10 x 10.5	260	10 x 10.5	280
1000	108	10 x 10.5	300	10 x 10.5	300				

Maximum Allowable Ripple Current (mA rms) at 105°C 120Hz

Case Size Φ D x L (mm)

Voltage (Code)		35V (1V)		50V (1H)	
Cap. (µF)	Code	Case Size	Ripple Current	Case Size	Ripple Current
0.1	104			4 x 6.0	1.0
0.22	224			4 x 6.0	2.6
0.33	334			4 x 6.0	3.2
0.47	474			4 x 6.0	4.0
1	105			4 x 6.0	8.0
2.2	225			4 x 6.0	11
3.3	335			4 x 6.0	14
4.7	475	4 x 6.0	16	5 x 6.0	19
10	106	5 x 6.0	27	6.3 x 6.0	32
22	226	6.3 x 6.0	44	6.3 x 8.0	58
33	336	6.3 x 8.0	57	6.3 x 8.0	70
47	476	6.3 x 8.0	68	8 x 10.5	124
100	107	8 x 10.5	120	10 x 10.5	200
220	227	10 x 10.5	220	10 x 10.5	230
330	337	10 x 10.5	260		

Maximum Allowable Ripple Current (mA rms) at 105°C 120Hz

Case Size Φ D x L (mm)

Specifications are subject to change without notice. Should a safety or technical concern arise regarding the product, please be sure to contact our sales offices or agents immediately.

總公司 HEAD OFFICE

香港

HONG KONG

萬裕電子有限公司

香港九龍紅磡鶴翔街8號

維港中心二期6樓03室

Man Yue Electronics Co., Ltd.

Unit 03, 6/F., Harbour Centre Tower 2,

8 Hok Cheung Street, Hung Hom,

Kowloon, Hong Kong

電話 TEL: (852) 2897 5277

傳真 FAX: (852) 2558 6299

分公司 BRANCH OFFICE

香港

HONG KONG

三信電子零件有限公司

香港九龍紅磡鶴翔街8號

維港中心二期6樓03室

Samxon Electronic Components Ltd.

Unit 03, 6/F., Harbour Centre Tower 2,

8 Hok Cheung Street, Hung Hom,

Kowloon, Hong Kong

電話 TEL: (852) 2897 5277

傳真 FAX: (852) 2558 6299

台灣

TAIWAN

香港商萬裕國際電子有限公司台灣分公司

台灣新北市23553中和區

連城路258號13樓之1

郵政編碼：23553

Man Yue Electronics Company Limited

Taiwan Branch (H.K.)

13F-1, No. 258 Liancheng Road,

Zhonghe District, New Taipei City,

Taiwan 23553, R.O.C.

Postal Code: 23553

電話 TEL: 886 (02) 8227 2227

傳真 FAX: 886 (02) 8227 2226

www.samxon.com

中國深圳 SHENZHEN, CHINA

萬晉電子(深圳)有限公司

中國深圳市羅湖區

中國深圳市羅湖區寶安南路2014號

振業大廈B座913·915房

郵政編碼：518000

Man Jin Electronics (Shenzhen) Co., Ltd.

Rm 913 & 915, Block B, 9/F., Zhenye Tower,

2014 Baoan South Road,

Luohu, Shenzhen City,

Guangdong Province, PR China

Postal Code: 518000

電話 TEL: 86 (755) 2586 2216

傳真 FAX: 86 (755) 2586 2239

中國上海 SHANGHAI, CHINA

萬發國際貿易(上海)有限公司

中國江蘇省無錫市錫山經濟開發區

東亭鎮春暉東路148號

郵政編碼：214101

Man Fat International Trading

(Shanghai) Co., Ltd.

148 Chunhui East Road, Dongting Town,

Xishan Economic Development Zone,

Wuxi, Jiangsu Province, PR China

Postal Code: 214101

電話 TEL: 86 (510) 8866 2688

傳真 FAX: 86 (510) 8865 2933

中國上海市寶山區

共和新路4995號611室

郵政編碼：200435

Room 611,

No.4995 Gong He Xin Road,

Baoshan District,

Shanghai, PR China

Postal Code: 200435

電話 TEL: 86 (021) 6639 2180

傳真 FAX: 86 (021) 6639 2180

中國廠址 PRC MANUFACTURING PLANTS

中國東莞

DONGGUAN, CHINA

萬裕三信電子(東莞)有限公司

中國廣東省東莞市長安鎮烏沙村

興發南路新星工業園

郵政編碼：523857

Samxon Electronics (Dongguan) Co., Ltd.

Xin Xing Industrial Area,

Xing Fa South Road, Wu Sha Village,

Changan Town, Dongguan,

Guangdong Province, PR China

Postal Code: 523857

電話 TEL: 86 (769) 8228 6000 / 8532 3339

傳真 FAX: 86 (769) 8541 6401

中國無錫

WUXI, CHINA

無錫萬裕電子有限公司

中國江蘇省無錫市錫山經濟開發區

東亭鎮春暉東路148號

郵政編碼：214101

Wuxi Man Yue Electronics Co., Ltd.

148 Chunhui East Road, Dongting Town,

Xishan Economic Development Zone,

Wuxi, Jiangsu Province, PR China

Postal Code: 214101

電話 TEL: 86 (510) 8866 2688

傳真 FAX: 86 (510) 8865 0388

X-ON Electronics

Largest Supplier of Electrical and Electronic Components

Click to view similar products for [Aluminium Electrolytic Capacitors - Radial Leaded](#) category:

Click to view products by [Man Yue](#) manufacturer:

Other Similar products are found below :

[LXY50VB4.7M-5X11](#) [RFO-100V471MJ7P#](#) [ECE-A1EGE220](#) [B41041A2687M8](#) [B41041A7226M8](#) [B41044A7157M6](#)
[EKXG201EC3101ML20S](#) [EKZM160ETD471MHB5D](#) [NCD681K10KVY5PF](#) [NEV1000M25EF-BULK](#) [NEV100M35DC](#) [NEV100M63DE](#)
[NEV220M25DD-BULK](#) [NEV.33M100AA](#) [NEV4700M50HB](#) [NEV.47M100AA](#) [NEVH1.0M250AB](#) [NEVH3.3M250BB](#) [NEVH3.3M450CC](#)
[KM4700/16](#) [KME50VB100M-8X11.5](#) [SG220M1CSA-0407](#) [ES5107M016AE1DA](#) [ESMG160ETD102MJ16S](#) [ESX472M16B](#)
[SZ010M1500A5S-1015](#) [227RZS050M](#) [476CKH100MSA](#) [477RZS050M](#) [UVX1V101KPA1FA](#) [UVX1V222MHA1CA](#) [KME25VB100M-](#)
[6.3X11](#) [VTL100S10](#) [VTL470S10](#) [VTL470S16A](#) [511D336M250EK5D](#) [052687X](#) [ECE-A1CF471](#) [EKMA500ELL4R7ME07D](#) [NRE-](#)
[S560M16V6.3X7TBSTF](#) [RGA221M1CTA-0611G](#) [ERZA630VHN182UP54N](#) [UPL1A331MPH](#) [SK035M0100AZS-0611](#) [MAL214658821E3](#)
[NEV1000M6.3DE](#) [NEV100M16CB](#) [NEV100M50DD-BULK](#) [NEV2200M16FF](#) [NEV220M50EE](#)