



X-CON

CONDUCTIVE POLYMER ALUMINUM SOLID CAPACITORS

2016-2017



QC 080000



ISO 9001 ISO 14001



ACCREDITED

目錄 Contents

產品一覽表 Series Table	P.3
產品體系圖 Series Chart	P.3
應用指引 Application Guidelines	P.4
產品編碼 Part Number System	P.8
編帶產品規格 Taping Specifications	P.9
成型產品規格 Lead Forming Specifications	P.9
貼片產品包裝規格 Specifications for SMD Type Packing	P.10
最少訂單量 Minimum Order Quantity	P.10
引線式導電高分子鋁質固態電容器 Radial Leaded Type Aluminum Solid Capacitors	P.11
貼片式導電高分子鋁質固態電容器 V-Chip Type Aluminum Solid Capacitors	P.27



X-CON[®]
Conductive Polymer
Aluminum Solid Capacitors

Features

Low ESR obtained by using conductive polymer electrolyte

- Suitable as a decoupling capacitor, because its impedance has ideal frequency characteristics.
- Suitable as a smoothing capacitor, enabling miniaturizing switching power supplies, because it allows large ripple current.
- Suitable as a backup capacitor for the circuits that consume large current at a high speed.

Pb-free compliant

- All the models are completely Pb-free and RoHS compliant products.

Long life

- Some special series can be expected 50,000 hours life at 85°C suitable for long-operating equipments.

Superior temperature characteristics

- Its ESR has stable characteristics at a temperature from -55°C to 105°C (partly 125°C), suitable for applications used at low temperatures (under 0°C).

Wide capacitance range from 1 μ F to 2700 μ F

- An array of various series covers wide capacitance range.

High voltage

- High reliability products have achieved the highest rated voltage 200V.

Applications

Use as a smoothing, backup and bypass capacitor used in various fields such as digital equipments, household appliances, computer-related hardware and industrial equipment.

Series Table

產品一覽表

Series Features (特點)		Temp (°C)	Voltage (VDC)	Cap. (µF)	Load Life	Appearance	Page
Radial Lead Type 引線式							
ULG	+105°C, High Ripple Current, Low ESR (高紋波, 低阻抗)	-55 ~ +105°C	2.5 to 35	10 to 1500	2,000 hours	Low ESR	P.11
ULR	+105°C, Higher Ripple Current, Lower ESR than ULG (高紋波, 比ULG更低阻抗)	-55 ~ +105°C	2.5 to 35	22 to 2700	2,000 hours	Lower ESR	P.14
UER	+105°C, Higher Ripple Current, Long Life 5,000 Hours (高紋波, 長壽命)	-55 ~ +105°C	2.5 to 35	100 to 2500	5,000 hours	Long Life	P.19
UPG	+105°C, High Voltage, Low ESR (高電壓, 低阻抗)	-55 ~ +105°C	50 to 200	1 to 120	2,000 hours	High Voltage	P.22
UBR	+125°C, High Temperature, Low ESR (高溫度, 低阻抗)	-55 ~ +125°C	2.5 to 100	10 to 1200	1,000 hours	High Temperature	P.25
USR	Discontinued Item	** End of life series, replaced by ULR series. 停產系列, 以ULR系列取代。					
V-Chip Type 貼片式							
UVG	+105°C, Surface Mount Type, Low ESR (貼片標準品, 低阻抗)	-55 ~ +105°C	2.5 to 25	10 to 820	2,000 hours	Low ESR V-Chip	P.27
UVR	+105°C, Surface Mount Type, Lower ESR than UVG (貼片標準品, 比UVG更低阻抗)	-55 ~ +105°C	2.5 to 16	39 to 2200	2,000 hours	Lower ESR V-Chip	P.30

Series Chart

產品體系圖

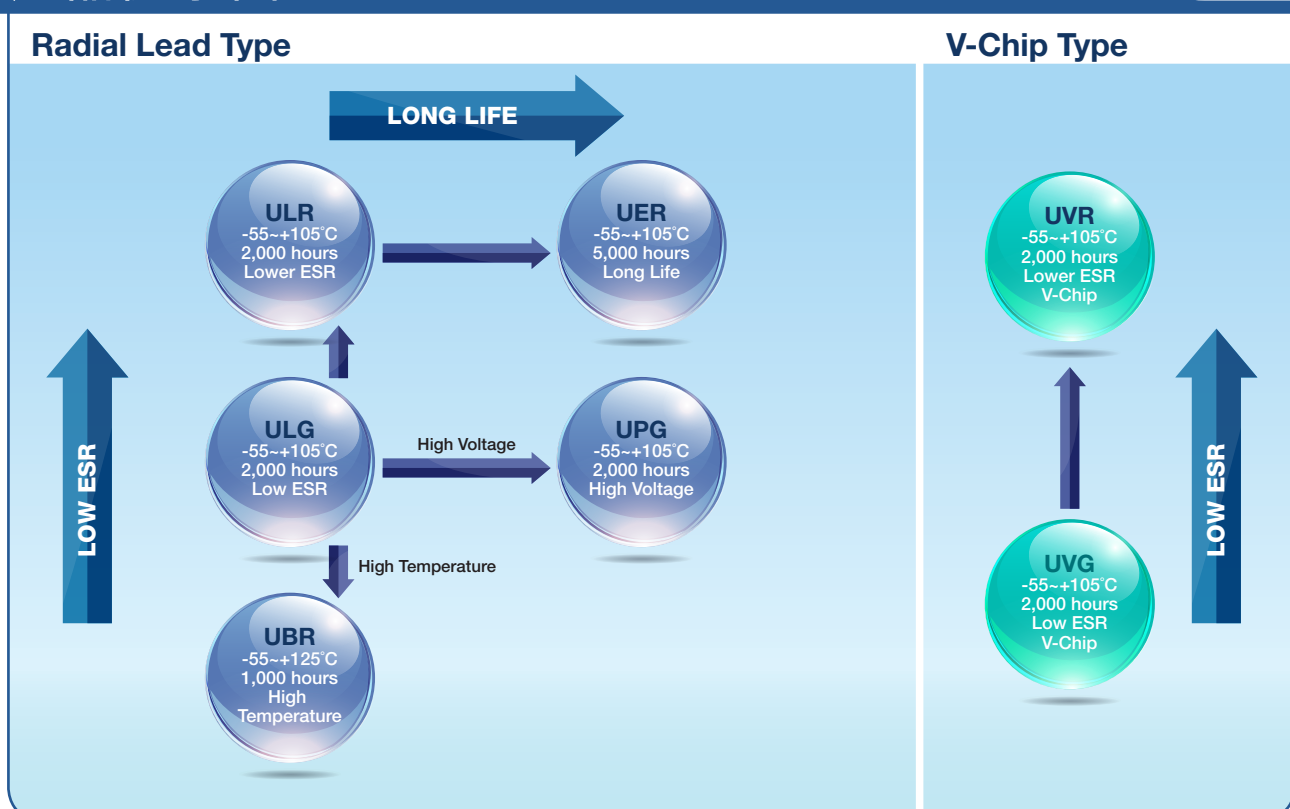

應用指引

X-CON should be used in compliance with the following guidelines.

1. Circuit Design

1.1 Prohibited Circuits

Do not use the capacitors in the following circuits, because leakage current may increase.

- 1) Time constant circuits
- 2) Coupling circuits
- 3) Circuits which are greatly affected by leakage current
- 4) High impedance voltage retention circuits

1.2 Polarity

X-CON is a polarized solid aluminum electrolytic capacitor with positive and negative electrodes. Do not apply reverse voltage on the capacitors, otherwise it may cause leakage current increase or life span decreased.

1.3 Voltage Applied

The applied voltage is equal to the voltage value including the peak value of the transitional instantaneous voltage and that of ripple voltage, not just steady line voltage.

- 1) Do not apply over-rated voltage or reverse voltage as it may lead to the increase in leakage current and short circuit.
- 2) When DC voltage is low, a negative ripple voltage peak value must not become a reverse voltage that exceeds 10% of the rated voltage.

1.4 Restriction on Sudden Charge or Discharge

Sudden charge and discharge may result in short circuits or larger leakage current. Therefore, protection circuits are suggested to build in when one of the following conditions are anticipated.

- 1) The rush current exceeding 10A
- 2) The rush current exceeding 10 times of rated ripple current of X-CON

A protection resistor (1K Ω) must be inserted to the circuit during the charge and discharge when measuring the leakage current.

1.5 Ripple Current

Use the capacitors within the rated ripple current. When excessive ripple current is applied to the capacitor, it may cause the increase in leakage current and short circuits due to self-heating.

1.6 Leakage Current

There is a risk of leakage current increasing even if the following usage environments are within the suggested range. Owing to the self-correction mechanism, the leakage current returns to a small value in most cases after the application of voltage.

- 1) After soldering or re-flow
- 2) High temperature under no loading
- 3) High humidity under no loading
- 4) Sudden temperature changes

1.7 Capacitor Insulation

- 1) Insulation of the marked sleeve is not guaranteed. Be aware that the space between the case and the negative electrode terminal is not insulated and has some resistance.
- 2) Completely separate the case, negative lead terminal, positive lead terminal and PCB patterns with each other.

1.8 Precautions for Using Capacitors

X-CON capacitors should not be used in the following environments.

- 1) Direct contact with salt water, oil & chemically active gases
- 2) Exposure direct under sunlight
- 3) High temperature owing to heat generating components around the X-CON and on the underside of the PCB
- 4) High humidity where condensation can form on the surface of the capacitor
- 5) Acid or alkaline environments
- 6) High-frequency induction
- 7) Excessive vibration and shock

2. Failure and Life-span

The failure rate is 0.5% / 1,000 hours (with a 60% reliability standard) based on JIS-C-5003. The mainly failure modes are as follows.

2.1 Contingency Failure

The main causes of failure are thermal stresses cause by the soldering or thermal use environment, along with heat stresses, electrical stresses or mechanical stresses.

The most common failure mode is a short circuit.

Application Guidelines

應用指引

- a) Phenomenon after a short circuit
 - 1) If the pass-through current is 1A or less on $\Phi 10$, 0.5A or less on $\Phi 8$ and 0.2A or less on $\Phi 6.3$ in case of a short circuit, the X-CON will become heated, but no effects are visible even when the current is continuously carried.
 - 2) If the short circuit currents exceed the mentioned value above, the temperature inside the X-CON will increase. The rubber sealing will be turned over and odorous gas will be released. In this case, keep your face and hands away from the area.
- b) In case a short circuit occurs, ensure safety by fully considering the followings.
 - 1) If odorous gas is released, turn off the main power of the equipment.
 - 2) If the gas comes in contact with eyes, rinse immediately. If the gas is inhaled, gargle immediately.
 - 3) Do not lick the electrolyte. If the electrolyte comes in contact with skin, wash it off with soap immediately.
 - 4) X-CON contains combustible substances. In case a large current continues to flow after a short circuit, in the worst case, the shorted-out section may ignite. For safety, install a redundant circuit or a protective circuit, etc.

2.2 Wear-out Failure (Life-span)

When life span exceeded the specified guarantee time of Endurance and Damp heat, electrolyte might insulate and cause electric characteristic changed. This is called an open circuit. The electric characteristics of capacitance and ESR may possibly change within the specified range in specifications when it is used under the condition of the rated voltage, electric and mechanical performance. Please note it when design.

3. Mounting Precautions

Phases	Things to be noted	Disposition												
Before mounting	1) Check the marking on the body	Don't use products without marked polar, capacitance and rated voltage.												
	2) Check the pitch between lead terminal and PCB	Use X-CON only when the said pitch is matched.												
	3) Find the leakage current increased after long storage	Apply the capacitor with rated voltage in series with 1K Ω resistance for 1 hour at the range between 60 and 70°C.												
	4) Drop to the floor	Don't use												
	5) Handling	Use X-CON with lead terminal and body not subject to any stress.												
	6) Adopt a used X-CON	No re-used												
Mounting	1) Soldering with a soldering iron	<ul style="list-style-type: none"> • Meet the temperature and duration requirements of out-going specification; • Not allow any stress during mounting; • Don't let the tip of the soldering iron touch X-CON. 												
	2) Flow soldering (for radial type)	<ul style="list-style-type: none"> • Don't submerge X-CON body in melted solder; • Meet the temperature and duration requirements of out-going specification; • Not allow the flux to adhere to anywhere except the lead terminal. <p>The details for flow soldering are as follows:</p> <table border="1"> <thead> <tr> <th></th> <th>Temperature</th> <th>Duration</th> <th>Flow times</th> </tr> </thead> <tbody> <tr> <td>Preheating</td> <td>$\leq 120^{\circ}\text{C}$ (ambient temp.)</td> <td>$\leq 120\text{sec.}$</td> <td>1</td> </tr> <tr> <td>Soldering conditions</td> <td>$\leq (260 \pm 5)^{\circ}\text{C}$</td> <td>$\leq (10 \pm 1)\text{sec.}$</td> <td>$\leq 2$</td> </tr> </tbody> </table>		Temperature	Duration	Flow times	Preheating	$\leq 120^{\circ}\text{C}$ (ambient temp.)	$\leq 120\text{sec.}$	1	Soldering conditions	$\leq (260 \pm 5)^{\circ}\text{C}$	$\leq (10 \pm 1)\text{sec.}$	≤ 2
		Temperature	Duration	Flow times										
Preheating	$\leq 120^{\circ}\text{C}$ (ambient temp.)	$\leq 120\text{sec.}$	1											
Soldering conditions	$\leq (260 \pm 5)^{\circ}\text{C}$	$\leq (10 \pm 1)\text{sec.}$	≤ 2											
3) Reflow soldering (for SMD type)	Allow for UVG, UVR series. (see page 7 for details)													
After mounting	1) Handling	<ul style="list-style-type: none"> • Do not tilt, bend, twist X-CON; • Do not allow other things touching X-CON. 												
	2) Wash the PCB (Suggested cleaning agents) <ul style="list-style-type: none"> • High quality alcohol-based cleaning fluids such as st-100s, 750L, 750M; • Detergents including substitute freon such as AK-225AES and IPA) 	<ul style="list-style-type: none"> • Use immersion or ultrasonic waves to clean for a total of less than 5 minutes and adjust the temperature of the agents not higher than 60°C; • Observe the contamination of the agents (conductivity, pH, specific gravity, water cleaning and etc.); • Dry X-CON in hot air with the air temperature less than the maximum operating temperature. 												

4. Reflow Soldering Conditions

Item	Recommended Condition 1	Recommended Condition 2
	Peak Temperature	260°C or less
Preheating	150°C to 180°C 90 seconds	150°C to 180°C 90 seconds
A	200°C and higher Within 60 seconds	200°C and higher Within 60 seconds
B	230°C and higher Within 40 seconds	230°C and higher Within 40 seconds
The number of reflow	Only 1 time	Twice or less

All temperatures are measured on the topside of the Al-can and terminal surface.

Attention:

Reflow soldering may reduce the capacitance of products before or after soldering even if meeting soldering conditions per Recommended Reflow Condition. Soldering considerably deviating from these conditions will cause problems such as a 50% reduction in capacitance, and a considerable increase in leakage current. Thus, the peak temperature at the top of Al-case/Electrode terminals and the duration of the reflow over 200°C should not exceed the specifications.

5. Emergency Procedure

If the capacitor is overheated, the resin case may emit smoke. If this occurs, immediately switch off the unit's main power supply to stop operation. Keep your body away from the capacitor as the temperature may be high enough to cause the capacitor to ignite and burn.

6. Disposal and Storage Conditions

6.1 Disposal

Since capacitors are composed of various metals and resins, dispose them as industrial waste.

6.2 Storage Conditions

- Do not store the X-CONs in the environment of high temperature and high humidity, or in the location subject to direct sunlight. The X-CONs should be stored under the conditions within 5°C ~ 35°C and relative humidity below 75%;
- Store the X-CONs in the condition as they are shipped to keep good solder ability. SMD types (UVR and UVG series) should be sealed in specifically designed aluminum laminate bags to avoid deterioration in characteristics and solder ability before and after reflows, which results from moisture absorption;
- Store the X-CONs in sealed package bags after delivery per the table below;

X-CON type	Before unsealing	After unsealing
Radial lead type packed in bags	Must be used within 24 months after delivery (unsealed status)	Must be used within a week (opened status)
Radial lead type packed in taping method	Must be used within 24 months after delivery (unsealed status)	Must be used within a week (opened status)
SMD type	Must be used within 24 months after delivery (unsealed status)	Must be used within a week (opened status)

- Don't open package bags until mounting, and use up all products once open. In case of leftovers, pack radial lead types in bags, return SMD types and unpackaged ones back into special storage bags (designed aluminum laminate bags for SMD types), and seal up the opening. Put radial lead types with taping in plastic bags as they are put into storage boxes and seal up the opening, too. Regarding leftover storage, please follow the storage instructions as shown in above table;
- Don't store X-CONs in damp conditions or as stated in Item 1.8;
- Don't store X-CONs in places filled with toxic gases or susceptible to ozone, ultraviolet ray and radiation.

Application Guidelines

應用指引

7. Compliance with RoHS Directive

Our company is committed to comply with the European Union Restriction of Hazardous Substance (RoHS) Directive. We hereby guarantee that our products do not contain the following materials exceeding the content regulated in RoHS Directive.

Lead (Pb)	≤1000ppm
Mercury (Hg)	≤1000ppm
Cadmium (Cd)	≤100ppm
Hexavalent Chromium, Cr ⁶⁺	≤1000ppm
Polybrominated Biphenyls (PBBs)	≤1000ppm
Polybrominated Diphenyl Ethers (PBDEs)	≤1000ppm

8. Halogen Free Compliant

The products identified in the catalogue, and their homogeneous subcomponents, do not contain any of the following substances in concentrations greater than the listed maximum limits.

Substance	Maximum Limit (ppm)
Bromine (Br)	900 ppm (0.09%)
Chlorine (Cl)	900 ppm (0.09%)
Total concentration of Chlorine (Cl) + Bromine (Br)	1500 ppm (0.15%)

9. Reliability Presumption of Life

$$L_x = L_0 \times 10^{\frac{T_0 - T_x}{20}}$$

L_x: Life expectancy (Hours) in actual use (T_x)

L₀: Guaranteed (Hours) at maximum temperature (T₀)

T₀: Maximum operating temperature (°C)

T_x: Temperature in actual use (Ambient temperature of X-CON) (°C)

Owing to the excellent heat-proof characteristics of conductive polymer, the estimated life expectancy can be calculated without consideration of self-heating under application of the ripple current.

10. General Electrical Characteristics of X-CON

Temperature Variation on ESR (Ω)

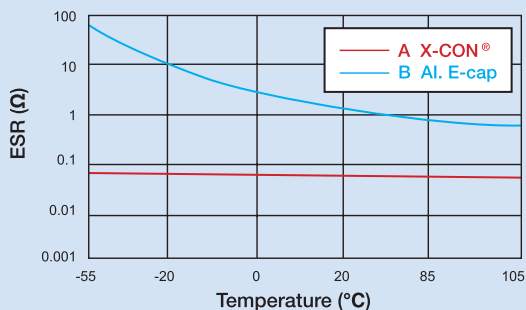

Frequency Variation on ESR

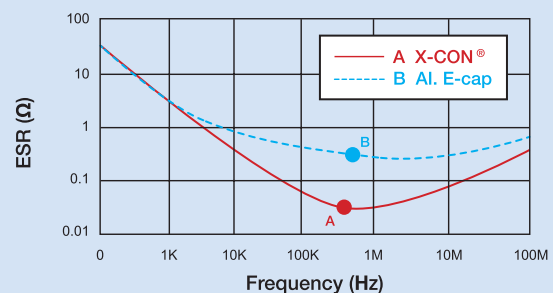

Part Number System

產品編碼

1 2 3 ULR			4 5 6 567			7 M		8 9 0G		10 F		11 12 08		13 14 RR	
Series			Capacitance			Tolerance		Voltage		Case Dia.		Case Length		Type	
Series	Cap. (µF)	Code	Tol. (%)	Code	Vol. (V)	Code	Dia. (mm)	Code	Len. (mm)	Code	Feature	Code			
ULG	3.3	335	±20	M	2.5	0E	4	C	4.2	42	Bulk	RR			
ULR	10	106			4	0G	5	D	4.5	45	Lead Cut & Form	CB			
UER	22	226			6.3	0J	5.5	X	5	05					
UPG	33	336			6.8	06	6.3	E	5.5	55	Taping F=2.0mm	TT			
UBR	47	476			7	0S	8	F	6	06					
UVG	68	686			7.5	07	10	G	6.5	65	Taping F=2.5mm	TU			
UVR	100	107			10	1A			7	07					
	150	157			12	10			7.5	75	Taping F=3.5mm	TV			
	180	187			14	14			8	08					
	220	227			16	1C			8.5	85	Taping F=5.0mm	TC			
	270	277			20	1D			9	09					
	330	337			25	1E			10	10	Tape & Reel	TR			
	390	397			35	1V			10.2	T2					
	470	477			50	1H			10.5	1K					
	560	567			63	1J			11	11					
	680	687			80	1K			11.5	1A					
	820	827			100	2A			12	12					
	1000	108			200	2D			12.5	1B					
	1200	128							16	16					
	1500	158													
	1800	188													
	2200	228													
	2500	258													
	2700	278													

Taping Specifications

編帶產品規格

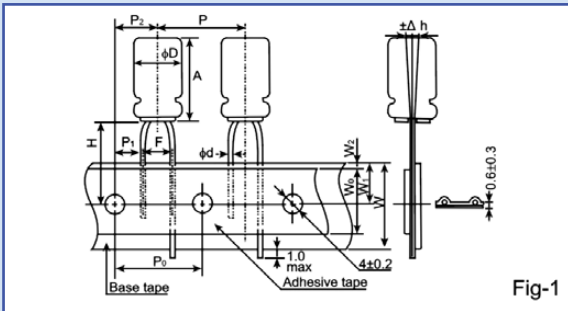

Fig-1

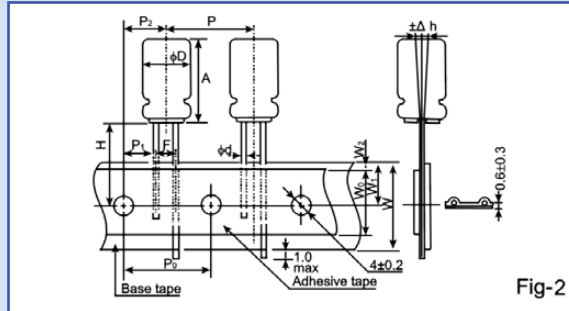

Fig-2

Specifications

Item		Dimensions (mm)				
		Fig. 1	5	6.3	8	10
Reference Figure		Fig. 1			Fig. 2	
Diameter	D	4	5	6.3	8	10
Height	A	5~11	7~11	8~11	8~11.5	12.5
Lead Diameter	d±0.05	0.45~0.6	0.45~0.6	0.45~0.6	0.6	0.6
Component Spacing	P±1.0	12.7	12.7	12.7	12.7	12.7
Pitch of sprocket holes	P0±0.2	12.7	12.7	12.7	12.7	12.7
Distance between centers of terminal and the sprocket holes	P1±0.5	5.35	5.35	5.1	4.6	3.85
Distance between centers of the component and the sprocket holes	P2±1.0	6.35	6.35	6.35	6.35	6.35
Distance between centers of component leads	F ^{+0.8} _{-0.5}	2.0	2.0	2.5	3.5	5.0
Carrier tape width	W±0.5	18.0	18.0	18.0	18.0	18.0
Hold down tape width	W0	7.0min	7.0min	7.0min	7.0min	7.0min
Distance between the center of upper edge of carrier tape and sprocket hole	W1±0.5	9.0	9.0	9.0	9.0	9.0
Distance between the upper edges of the carrier tape and the hold down tape	W2	3max	3max	3max	3max	3max
Distance between the abscissa and the bottom of the components body	H ^{+0.75} _{-0.5}	18.5	18.5	18.5	18.5	18.5
Distance between the abscissa and the reference plane of the components with crimped leads	H0±0.5	-	-	-	-	-
Max. lateral deviation of the component body vertical to the tape plane	Δh±1.0	0	0	0	0	0

Lead Forming Specifications

成型產品規格

CB Type

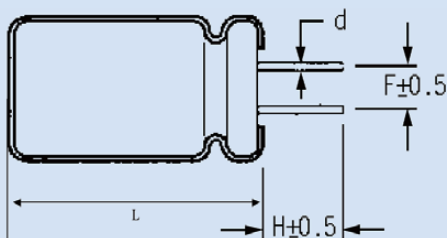

(Unit: mm)					
Shape Code	ΦD	5	6.3	8	10
CB	F	2.0	2.5	3.5	5.0
	H	3.2	3.2	3.2	3.2
	Φd±0.05	L<8mm, d≤0.5 L≥8mm, d=0.6			

Specifications for SMD Type Packing

貼片產品包裝規格

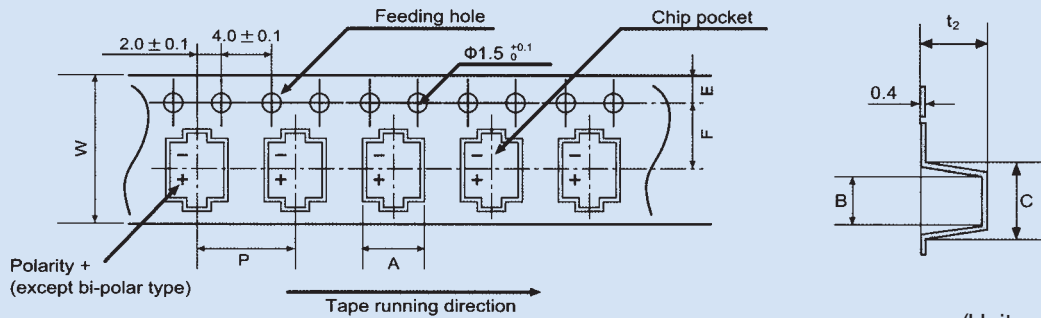

(Unit: mm)

Size	Dimensions	A	B	C	W	F	E	P	t ₂
Φ6.3 x 5.9/6		6.9 ±0.2	6.9 ±0.5	9.0 ±0.5	16.0 ±0.3	7.5 ±0.2	1.75 ±0.2	12.0 ±0.2	6.5 ±0.5
Φ6.3 x 8		6.9 ±0.2	6.9 ±0.5	9.5 ±0.5	16.0 ±0.3	7.5 ±0.2	1.75 ±0.2	12.0 ±0.2	8.2 ±0.5
Φ8 x 8		8.6 ±0.2	8.6 ±0.5	11.7 ±0.5	24.0 ±0.3	11.5 ±0.2	1.75 ±0.2	16.0 ±0.2	9.0 ±0.5
Φ8 x 10.2		8.6 ±0.2	8.6 ±0.5	12.5 ±0.5	24.0 ±0.3	11.5 ±0.2	1.75 ±0.2	16.0 ±0.2	11.0 ±0.5
Φ8 x 12		8.6 ±0.2	8.6 ±0.5	12.5 ±0.5	24.0 ±0.3	11.5 ±0.2	1.75 ±0.2	16.0 ±0.2	12.7 ±0.5

a. Reel

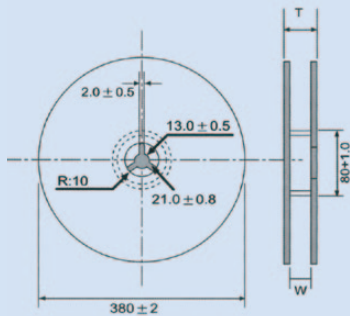

b. Polarity

(Unit: mm)

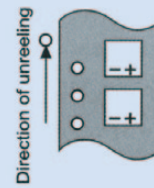

Size	W	T
Φ6.3 x 5.9/6 Φ6.3 x 8	17.0±1.0	21.5±1.0
Φ8 x 8 Φ8 x 10.2 Φ8 x 12	25.0±1.0	29.5±1.0

Minimum Order Quantity

最少訂單量

Size of product 產品尺寸			Bulk 散裝						Taping 編帶	
			最少包裝量 (MPQ)			最少訂單量 (MOQ)			最少包裝量 (MPQ)	最少訂單量 (MOQ)
			Long lead 長短腳	Lead forming 成型		Long lead 長短腳	Lead forming 成型			
Cut 直腳	Formed 彎腳	Cut 直腳		Formed 彎腳						
Chip type 貼片式	Φ5	6L	-						1,250	1,250
		4.2L, 4.5L	-						1,500	1,500
	Φ6.3	5.9L, 6L	-						1,250	1,250
		8L, 9L	-						1,000	1,000
	Φ8	7.7L, 8L	-						500	500
		10.2L	-						500	500
		12L	-						400	400
Φ10	10.2L	-						500	500	
	12.5L	-						300	300	
Radial lead type 導針型	Φ4	6.5L~7L	1,000	2,000	-	4,000	4,000	-	-	-
		Φ5-Φ5.5	6~11L	1,000	1,000	1,000	4,000	4,000	4,000	2,000
	Φ6.3	5~6L	1,000	1,000	1,000	4,000	4,000	4,000	1,500	1,500
		7~11L	1,000	1,000	1,000	3,000	3,000	3,000	1,500	1,500
	Φ8	6.5~9L	500	1,000	-	2,000	2,000	-	1,000	1,000
		11.5L, 16L	500	500	500	2,000	2,000	2,000	1,000	1,000
Φ10	9~12.5L, 16L	400	500	-	1,200	1,500	-	500	500	

ULG Series

+105°C, High Ripple Current, Low ESR

Features

- High Ripple Current, Low ESR
- Wide Temperature Range
- RoHS Compliant

Applications

- Suitable for DC-DC Converters, Voltage Regulators, Decoupling Applications for Computer Motherboards, etc.

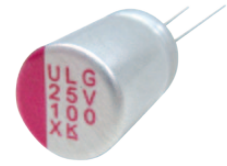

Specifications

Item	Performance Characteristics				
Operating Temperature Range	-55 to +105°C				
Rated Working Voltage Range	2.5VDC to 35VDC				
Surge Voltage, SV	SV=VVx1.15VDC (Normal temperature)				
Nominal Capacitance Range	10 to 1500μF (120Hz, +20°C)				
Capacitance Tolerance	±20% (120Hz, +20°C)				
tan δ	0.12 (120Hz, +20°C)				
Leakage Current, Lc	I≤0.2CV or 280 (μA) whichever is greater measured, after 2 minutes application of rated working voltage at +20°C				
Temperature Characteristics, Impedance Ratio	At -55°C 100kHz (Low temperature)			Z/Z20°C≤1.25	
	At +105°C 100kHz (High temperature)			Z/Z20°C≤1.25	
Frequency Coefficient for Allowable Ripple Current	Frequency	120Hz≤f<1kHz	1kHz≤f<10kHz	10kHz≤f<100kHz	100kHz≤f<500kHz
	Coefficient	0.05	0.30	0.70	1.00
Endurance	Test conditions +105°C, 2,000 hours Rated voltage applied	ΔC/C	Within ±20% of the initial measured value		
		tan δ	≤150% of the initial specified value		
		ESR	≤150% of the initial specified value		
		Lc	≤The initial specified value		
Damp Heat Test (Steady State)	Test conditions +60°C, 90% to 95% RH 1,000 hours No applied voltage	ΔC/C	Within ±20% of the initial measured value		
		tan δ	≤150% of the initial specified value		
		ESR	≤150% of the initial specified value		
		Lc	≤The initial specified value		
Surge Voltage Test	At normal temperature, charge at surge voltage for 30 sec, and discharge via a 1kΩ protective resistor for 330 sec. Repeat for 1,000 cycles.	ΔC/C	Within ±20% of the initial measured value		
		tan δ	≤150% of the initial specified value		
		ESR	≤150% of the initial specified value		
		Lc	≤The initial specified value		
Others	JIS-C-5101-4				

Dimensions

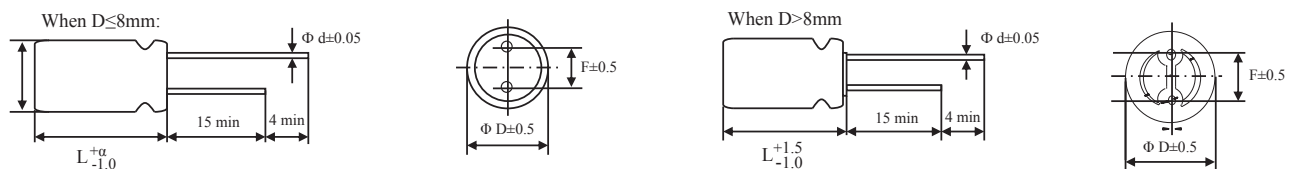

ULG Series

+105°C, High Ripple Current, Low ESR

ULG Series

Size List

 New Item | RV: Rated Voltage

μF \diagdown RV	Code	2.5 (0E)	4 (0G)	6.3 (0J)	10 (1A)	16 (1C)	20 (1D)	25 (1E)	35 (1V)
10	106								E08 ^(N)
22	226							D08 ^(N) , E08	F08
33	336						E08	E08, F08	E08 ^(N) , F08
47	476						F08	D08 ^(N) , E06 ^(N) , F08	E06 ^(N) , F08, F1A
56	566							F08	
68	686						E11 ^(N)		
100	107						F1A	E08 ^(N) , F1A, G1B	E11 ^(N) , F08, F1A, G1B
150	157						G1B	E11 ^(N) , F1A	
180	187					F1A		F1A	
220	227							F1A ^(N) , G1B	F1A ^(N) , G1B
270	277				F1A				
330	337					G1B		G1B	G1B
390	397			F1A			F1A ^(N)	G1B	
470	477				G1B			F1A ^(N) , G1B	
560	567		F1A						
680	687	F1A		G1B			F16 ^(N) , G1A ^(N)	F16 ^(N)	
820	827		G1B						
1500	158	G1B							

(Unit: mm)

Size Code	D08	E06	E08	E11	F08	F1A	F16	G1A	G1B
$\Phi\text{D} \times \text{L}$	5 x 8	6.3 x 6	6.3 x 8	6.3 x 11	8 x 8	8 x 11.5	8 x 16	10 x 11.5	10 x 12.5
$F \pm 0.5$	2.0	2.5	2.5	2.5	3.5	3.5	3.5	5.0	5.0
Φd	0.6	0.45	0.6	0.6	0.6	0.6	0.6	0.6	0.6
α	1.0	1.0	1.0	1.5	1.0	1.5	1.5	1.5	1.5

Specifications are subject to change without notice. Should a safety or technical concern arise regarding the product, please be sure to contact our sales offices or agents immediately.

+105°C, High Ripple Current, Low ESR

Characteristics List

Rated Vol. (V)	Rated Cap. (μF)	Case Size ΦD x L (mm)	Size Code	Part Number	ESR (mΩ, max/ 20°C, 100kHz)	Rated Ripple (mArms/ 105°C, 100kHz)	DF (%max)	Leakage Current (μA/2 mins)
2.5	680	8 x 11.5	F1A	ULG687M0EF1A	10	5230	12	340
2.5	1500	10 x 12.5	G1B	ULG158M0EG1B	8	5500	12	750
4	560	8 x 11.5	F1A	ULG567M0GF1A	10	5230	12	448
4	820	10 x 12.5	G1B	ULG827M0GG1B	8	5500	12	656
6.3	390	8 x 11.5	F1A	ULG397M0JF1A	12	4770	12	491
6.3	680	10 x 12.5	G1B	ULG687M0JG1B	10	5500	12	857
10	270	8 x 11.5	F1A	ULG277M1AF1A	14	4420	12	540
10	470	10 x 12.5	G1B	ULG477M1AG1B	12	5300	12	940
16	180	8 x 11.5	F1A	ULG187M1CF1A	16	4360	12	576
16	330	10 x 12.5	G1B	ULG337M1CG1B	14	5050	12	1056
20	33	6.3 x 8	E08	ULG336M1DE08	45	1880	12	280
20	47	8 x 8	F08	ULG476M1DF08	42	1952	12	280
20	68	6.3 x 11	E11	ULG686M1DE11	55	1500	12	280
20	100	8 x 11.5	F1A	ULG107M1DF1A	35	2670	12	400
20	150	10 x 12.5	G1B	ULG157M1DG1B	35	2672	12	600
20	390	8 x 11.5	F1A	ULG397M1DF1A	35	2670	12	1560
20	680	8 x 16	F16	ULG687M1DF16	16	4650	12	2720
20	680	10 x 11.5	G1A	ULG687M1DG1A	30	2800	12	2720
25	22	5 x 8	D08	ULG226M1ED08	80	900	12	280
25	22	6.3 x 8	E08	ULG226M1EE08	55	1700	12	280
25	33	6.3 x 8	E08	ULG336M1EE08	80	1200	12	280
25	33	8 x 8	F08	ULG336M1EF08	50	1870	12	280
25	47	5 x 8	D08	ULG476M1ED08	60	1100	12	280
25	47	6.3 x 6	E06	ULG476M1EE06	50	1600	12	280
25	47	8 x 8	F08	ULG476M1EF08	45	1940	12	280
25	56	8 x 8	F08	ULG566M1EF08	40	2500	12	280
25	100	6.3 x 8	E08	ULG107M1EE08	50	1200	12	500
25	100	8 x 11.5	F1A	ULG107M1EF1A	40	2500	12	500
25	100	10 x 12.5	G1B	ULG107M1EG1B	40	4320	12	500
25	150	6.3 x 11	E11	ULG157M1EE11	40	2500	12	750
25	150	8 x 11.5	F1A	ULG157M1EF1A	40	2550	12	750
25	180	8 x 11.5	F1A	ULG187M1EF1A	40	2550	12	900
25	220	8 x 11.5	F1A	ULG227M1EF1A	35	2900	12	1100
25	220	10 x 12.5	G1B	ULG227M1EG1B	35	3100	12	1100
25	330	10 x 12.5	G1B	ULG337M1EG1B	45	3100	12	1650
25	390	10 x 12.5	G1B	ULG397M1EG1B	35	3100	12	1950
25	470	8 x 11.5	F1A	ULG477M1EF1A	35	2900	12	2350
25	470	10 x 12.5	G1B	ULG477M1EG1B	35	3100	12	2350
25	680	8 x 16	F16	ULG687M1EF16	16	4650	12	3400
35	10	6.3 x 8	E08	ULG106M1VE08	90	1500	12	280
35	22	8 x 8	F08	ULG226M1VF08	100	1600	12	280
35	33	6.3 x 8	E08	ULG336M1VE08	100	1300	12	280
35	33	8 x 8	F08	ULG336M1VF08	90	1700	12	280
35	47	6.3 x 6	E06	ULG476M1VE06	90	1250	12	329
35	47	8 x 8	F08	ULG476M1VF08	90	1500	12	329
35	47	8 x 11.5	F1A	ULG476M1VF1A	90	1500	12	329
35	100	6.3 x 11	E11	ULG107M1VE11	75	1800	12	700
35	100	8 x 8	F08	ULG107M1VF08	80	1900	12	700
35	100	8 x 11.5	F1A	ULG107M1VF1A	55	2000	12	700
35	100	10 x 12.5	G1B	ULG107M1VG1B	65	1870	12	700
35	220	8 x 11.5	F1A	ULG227M1VF1A	55	2000	12	1540
35	220	10 x 12.5	G1B	ULG227M1VG1B	55	2450	12	1540
35	330	10 x 12.5	G1B	ULG337M1VG1B	45	2700	12	2310

Specifications are subject to change without notice. Should a safety or technical concern arise regarding the product, please be sure to contact our sales offices or agents immediately.

ULR Series

+105°C, Higher Ripple Current, Lower ESR than ULG

Features

- Higher Ripple Current, Lower ESR than ULG
- Wide Temperature Range
- RoHS Compliant

Applications

- Suitable for DC-DC Converters, Voltage Regulators, Decoupling Applications for Computer Motherboards, etc.



Specifications

Item	Performance Characteristics				
Operating Temperature Range	-55 to +105°C				
Rated Working Voltage Range	2.5VDC to 35VDC				
Surge Voltage, SV	SV=WVx1.15VDC (Normal temperature)				
Nominal Capacitance Range	22 to 2700μF (120Hz, +20°C)				
Capacitance Tolerance	±20% (120Hz, +20°C)				
tan δ	0.10 (120Hz, +20°C)				
Leakage Current, Lc	I ≤ 0.2CV or 280 (μA) whichever is greater measured, after 2 minutes application of rated working voltage at +20°C				
Temperature Characteristics, Impedance Ratio	At -55°C 100kHz (Low temperature)			Z/Z20°C ≤ 1.25	
	At +105°C 100kHz (High temperature)			Z/Z20°C ≤ 1.25	
Frequency Coefficient for Allowable Ripple Current	Frequency	120Hz ≤ f < 1kHz	1kHz ≤ f < 10kHz	10kHz ≤ f < 100kHz	100kHz ≤ f < 500kHz
	Coefficient	0.05	0.30	0.70	1.00
Endurance	Test conditions +105°C, 2,000 hours Rated voltage applied	ΔC/C	Within ±20% of the initial measured value		
		tan δ	≤ 150% of the initial specified value		
		ESR	≤ 150% of the initial specified value		
		Lc	≤ The initial specified value		
Damp Heat Test (Steady State)	Test conditions +60°C, 90% to 95% RH 1,000 hours No applied voltage	ΔC/C	Within ±20% of the initial measured value		
		tan δ	≤ 150% of the initial specified value		
		ESR	≤ 150% of the initial specified value		
		Lc	≤ The initial specified value		
Surge Voltage Test	At normal temperature, charge at surge voltage for 30 sec. and discharge via a 1kΩ protective resistor for 330 sec. Repeat for 1,000 cycles.	ΔC/C	Within ±20% of the initial measured value		
		tan δ	≤ 150% of the initial specified value		
		ESR	≤ 150% of the initial specified value		
		Lc	≤ The initial specified value		
Others	JIS-C-5101-4				

Dimensions

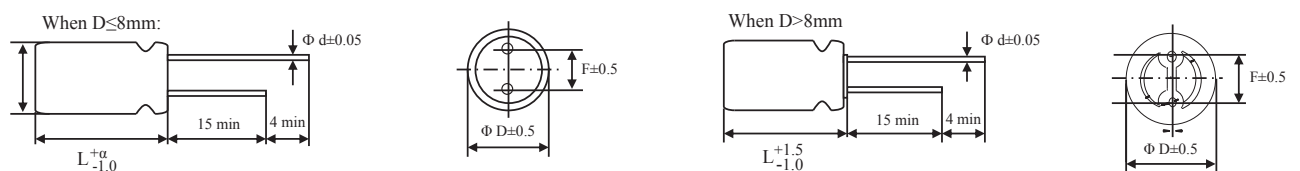

ULR Series

+105°C, Higher Ripple Current, Lower ESR than ULG

Size List

 New item | RV: Rated Voltage

RV μF	Code	2.5 (0E)	4 (0G)	6.3 (0J)	6.8 (06)	7 (0S)	7.5 (07)	10 (1A)	12 (1O)	14 (14)	16 (1C)	20 (1D)	25 (1E)	35 (1V)
22	226							E08			E06 [Ⓢ]		E08	
33	336							E08				E08	F08	
47	476							E08			E08	F08	F08	
100	107			E55			D07 [Ⓢ]				D09, E06, E07, E08, E11	F1A	F1A	F1A [Ⓢ] , G1B
150	157			C65		D06 [Ⓢ]		E11 [Ⓢ]				G1B		
180	187							E08			F1A			
220	227	E06		D07, E06, E08				E06, E07, E08			E11, F08, F1A		F1A [Ⓢ]	G1B
270	277		E08	D07, E06 [Ⓢ]				F08, F1A			E11, F08, F1A			
330	337	E08		D08, D09, X08 [Ⓢ] , E55 [Ⓢ] , E06, E08, F08		D09 [Ⓢ]	D09 [Ⓢ]	E08, F08 [Ⓢ] , F1A	D09 [Ⓢ]		E1K [Ⓢ] , E11 [Ⓢ] , F07, F08, F1A, G09, G1B		F1A [Ⓢ] , G1B	
390	397	E06		D09, F08				F08, F1A						
470	477	D09		D95 [Ⓢ] , D11 [Ⓢ] , X10 [Ⓢ] , E06 [Ⓢ] , E08, F08, F1A			E07 [Ⓢ]	E85 [Ⓢ] , E11 [Ⓢ] , F08, F1A, G1B			F1A, G1B			
500	507						D85 [Ⓢ]							
560	567	D08, D09, E06, E08, F08	E08, F08, F1A	E07 [Ⓢ] , E08, F08				F08, F1A		E10 [Ⓢ]				
680	687	F65 [Ⓢ] , F08	F08, F1A	E08, F08, F1A, G1B			E85 [Ⓢ]	F1A, G1B			F1A [Ⓢ] , G1B		F16 [Ⓢ]	
820	827	E08, F07 [Ⓢ] , F08, F1A	F08, F1A	E85 [Ⓢ] , E95 [Ⓢ] , E11 [Ⓢ] , F08, F1A, G1B		E10 [Ⓢ] , F08 [Ⓢ]	E11 [Ⓢ]	F1A			G1B			
1000	108	F08, F09, F1A	F08, G1B	E1K, F08, F1A, G1B	E11 [Ⓢ]			F1A [Ⓢ] , G1B			F16 [Ⓢ] , G1B		G16 [Ⓢ]	
1200	128	F08	F08, F1A, G1B	F1A				G1B						
1500	158	F1A, G1B		F1A, G1B										
2200	228			G1B [Ⓢ]										
2500	258			F16 [Ⓢ]										
2700	278	G1B	G1B											

(Unit: mm)

Size Code	C65	D06	D07	D08	D85	D09	D95	D11	X08	X10	E55	E06	E07	E08
ΦDxL	4 x 6.5	5 x 6	5 x 7	5 x 8	5 x 8.5	5 x 9	5 x 9.5	5 x 11	5.5 x 8	5.5 x 10	6.3 x 5.5	6.3 x 6	6.3 x 7	6.3 x 8
F±0.5	1.5	2.0	2.0	2.0	2.0	2.0	2.0	2.0	2.5	2.5	2.5	2.5	2.5	2.5
Φd	0.45	0.5	0.5	0.6	0.6	0.6	0.6	0.6	0.5	0.5	0.45	0.45	0.5	0.6
α	1.0	1.0	1.0	1.0	1.0	1.0	1.0	1.5	1.0	1.0	1.0	1.0	1.0	1.0

Size Code	E85	E95	E10	E1K	E11	F65	F07	F08	F09	F1A	F16	G09	G1B	G16
ΦDxL	6.3 x 8.5	6.3 x 9.5	6.3 x 10	6.3 x 10.5	6.3 x 11	8 x 6.5	8 x 7	8 x 8	8 x 9	8 x 11.5	8 x 16	10 x 9	10 x 12.5	10 x 16
F±0.5	2.5	2.5	2.5	2.5	2.5	3.5	3.5	3.5	3.5	3.5	3.5	5.0	5.0	5.0
Φd	0.6	0.6	0.6	0.6	0.6	0.6	0.6	0.6	0.6	0.6	0.6	0.6	0.6	0.6
α	1.0	1.0	1.0	1.0	1.5	1.0	1.0	1.0	1.0	1.5	1.5	1.5	1.5	1.5

Specifications are subject to change without notice. Should a safety or technical concern arise regarding the product, please be sure to contact our sales offices or agents immediately.

ULR Series

+105°C, Higher Ripple Current, Lower ESR than ULG

Characteristics List

Rated Vol. (V)	Rated Cap. (μF)	Case Size ΦD x L (mm)	Size Code	Part Number	ESR (mΩ, max/ 20°C, 100kHz)	Rated Ripple (mArms/ 105°C, 100kHz)	DF (%max)	Leakage Current (μA/2 mins)
2.5	220	6.3 x 6	E06	ULR227M0EE06	15	3400	10	280
2.5	330	6.3 x 8	E08	ULR337M0EE08	7	4200	10	280
2.5	390	6.3 x 6	E06	ULR397M0EE06	15	3400	10	280
2.5	470	5 x 9	D09	ULR477M0ED09	7	4180	10	280
2.5	560	5 x 8	D08	ULR567M0ED08	7	4180	10	280
2.5	560	5 x 9	D09	ULR567M0ED09	7	4180	10	280
2.5	560	6.3 x 6	E06	ULR567M0EE06	15	3400	10	280
2.5	560	6.3 x 8	E08	ULR567M0EE08	7	4000	10	280
2.5	560	8 x 8	F08	ULR567M0EF08	7	6100	10	280
2.5	680	8 x 6.5	F65	ULR687M0EF65	8	4900	10	340
2.5	680	8 x 8	F08	ULR687M0EF08	7	6100	10	390
2.5	820	6.3 x 8	E08	ULR827M0EE08	7	5600	10	410
2.5	820	8 x 7	F07	ULR827M0EF07	8	5600	10	410
2.5	820	8 x 8	F08	ULR827M0EF08	7	6100	10	410
2.5	820	8 x 11.5	F1A	ULR827M0EF1A	7	6100	10	410
2.5	1000	8 x 8	F08	ULR108M0EF08	7	6100	10	500
2.5	1000	8 x 9	F09	ULR108M0EF09	7	6100	10	500
2.5	1000	8 x 11.5	F1A	ULR108M0EF1A	7	6100	10	500
2.5	1200	8 x 8	F08	ULR128M0EF08	7	6100	10	600
2.5	1500	8 x 11.5	F1A	ULR158M0EF1A	7	6100	10	750
2.5	1500	10 x 12.5	G1B	ULR158M0EG1B	7	6100	10	750
2.5	2700	10 x 12.5	G1B	ULR278M0EG1B	8	5560	10	1350
4	270	6.3 x 8	E08	ULR277M0GE08	12	3200	10	280
4	560	6.3 x 8	E08	ULR567M0GE08	7	5600	10	448
4	560	8 x 8	F08	ULR567M0GF08	7	6100	10	448
4	560	8 x 11.5	F1A	ULR567M0GF1A	7	6100	10	448
4	680	8 x 8	F08	ULR687M0GF08	7	6100	10	544
4	680	8 x 11.5	F1A	ULR687M0GF1A	7	6100	10	544
4	820	8 x 8	F08	ULR827M0GF08	7	6100	10	656
4	820	8 x 11.5	F1A	ULR827M0GF1A	7	6100	10	656
4	1000	8 x 8	F08	ULR108M0GF08	7	6100	10	800
4	1000	10 x 12.5	G1B	ULR108M0GG1B	7	6640	10	800
4	1200	8 x 8	F08	ULR128M0GF08	7	6100	10	960
4	1200	8 x 11.5	F1A	ULR128M0GF1A	7	6100	10	960
4	1200	10 x 12.5	G1B	ULR128M0GG1B	8	5600	10	960
4	2700	10 x 12.5	G1B	ULR278M0GG1B	8	6900	10	2160
6.3	100	6.3 x 5.5	E55	ULR107M0JE55	80	1200	10	280
6.3	150	4 x 6.5	C65	ULR157M0JC65	100	2000	10	280
6.3	220	5 x 7	D07	ULR227M0JD07	11	3700	10	280
6.3	220	6.3 x 6	E06	ULR227M0JE06	20	3160	10	280
6.3	220	6.3 x 8	E08	ULR227M0JE08	20	3400	10	280
6.3	270	5 x 7	D07	ULR277M0JD07	11	3700	10	340
6.3	270	6.3 x 6	E06	ULR277M0JE06	20	3160	10	340
6.3	330	5 x 8	D08	ULR337M0JD08	12	2900	10	416
6.3	330	5 x 9	D09	ULR337M0JD09	11	3100	10	416
6.3	330	5.5 x 8	X08	ULR337M0JX08	12	2900	10	416
6.3	330	6.3 x 5.5	E55	ULR337M0JE55	20	3160	10	416
6.3	330	6.3 x 6	E06	ULR337M0JE06	20	3160	10	416
6.3	330	6.3 x 8	E08	ULR337M0JE08	10	4500	10	416
6.3	330	8 x 8	F08	ULR337M0JF08	8	5700	10	416
6.3	390	5 x 9	D09	ULR397M0JD09	11	3100	10	492
6.3	390	8 x 8	F08	ULR397M0JF08	8	5700	10	492
6.3	470	5 x 9.5	D95	ULR477M0JD95	10	3100	10	592
6.3	470	5 x 11	D11	ULR477M0JD11	11	3700	10	592
6.3	470	5.5 x 10	X10	ULR477M0JX10	11	3100	10	592

Specifications are subject to change without notice. Should a safety or technical concern arise regarding the product, please be sure to contact our sales offices or agents immediately.

ULR Series

+105°C, Higher Ripple Current, Lower ESR than ULG

Rated Vol. (V)	Rated Cap. (µF)	Case Size ΦD x L (mm)	Size Code	Part Number	ESR (mΩ, max/ 20°C, 100kHz)	Rated Ripple (mArms/ 105°C, 100kHz)	DF (%max)	Leakage Current (µA/2 mins)
6.3	470	6.3 x 6	E06	ULR477M0JE06	20	3160	10	592
6.3	470	6.3 x 8	E08	ULR477M0JE08	8	4700	10	592
6.3	470	8 x 8	F08	ULR477M0JF08	8	5700	10	593
6.3	470	8 x 11.5	F1A	ULR477M0JF1A	7	6100	10	592
6.3	560	6.3 x 7	E07	ULR567M0JE07	16	3500	10	706
6.3	560	6.3 x 8	E08	ULR567M0JE08	8	4700	10	706
6.3	560	8 x 8	F08	ULR567M0JF08	8	5700	10	706
6.3	680	6.3 x 8	E08	ULR687M0JE08	8	4700	10	857
6.3	680	8 x 8	F08	ULR687M0JF08	8	5700	10	857
6.3	680	8 x 11.5	F1A	ULR687M0JF1A	7	6100	10	857
6.3	680	10 x 12.5	G1B	ULR687M0JG1B	7	6640	10	857
6.3	820	6.3 x 8.5	E85	ULR827M0JE85	8	4700	10	1033
6.3	820	6.3 x 9.5	E95	ULR827M0JE95	8	5030	10	1033
6.3	820	6.3 x 11	E11	ULR827M0JE11	8	5400	10	1033
6.3	820	8 x 8	F08	ULR827M0JF08	7	6100	10	1033
6.3	820	8 x 11.5	F1A	ULR827M0JF1A	7	6100	10	1033
6.3	820	10 x 12.5	G1B	ULR827M0JG1B	7	6640	10	1033
6.3	1000	6.3 x 10.5	E1K	ULR108M0JE1K	8	4700	10	1260
6.3	1000	8 x 8	F08	ULR108M0JF08	7	6100	10	1260
6.3	1000	8 x 11.5	F1A	ULR108M0JF1A	7	6100	10	1260
6.3	1000	10 x 12.5	G1B	ULR108M0JG1B	10	5500	10	1260
6.3	1200	8 x 11.5	F1A	ULR128M0JF1A	7	6100	10	1512
6.3	1500	8 x 11.5	F1A	ULR158M0JF1A	10	5500	10	1890
6.3	1500	10 x 12.5	G1B	ULR158M0JG1B	10	5560	10	1890
6.3	2200	10 x 12.5	G1B	ULR228M0JG1B	10	5560	10	2772
6.3	2500	8 x 16	F16	ULR258M0JF16	8	6100	10	3150
6.8	1000	6.3 x 11	E11	ULR108M06E11	11	4650	10	1033
7	150	5 x 6	D06	ULR157M0SD06	12	2900	10	280
7	330	5 x 9	D09	ULR337M0SD09	11	3100	10	462
7	820	6.3 x 10	E10	ULR827M0SE10	10	4930	10	1148
7	820	8 x 8	F08	ULR827M0SF08	10	5030	10	1148
7.5	100	5 x 7	D07	ULR107M07D07	12	2900	10	280
7.5	330	5 x 9	D09	ULR337M07D09	12	3100	10	495
7.5	470	6.3 x 7	E07	ULR477M07E07	12	4050	10	705
7.5	500	5 x 8.5	D85	ULR507M07D85	12	4000	10	750
7.5	680	6.3 x 8.5	E85	ULR687M07E85	8	4700	10	1020
7.5	820	6.3 x 11	E11	ULR827M07E11	11	4700	10	1230
10	22	6.3 x 8	E08	ULR226M1AE08	45	1870	10	280
10	33	6.3 x 8	E08	ULR336M1AE08	35	2000	10	280
10	47	6.3 x 8	E08	ULR476M1AE08	32	2100	10	280
10	150	6.3 x 11	E11	ULR157M1AE11	25	2820	10	300
10	180	6.3 x 8	E08	ULR187M1AE08	25	2820	10	360
10	220	6.3 x 6	E06	ULR227M1AE06	15	2700	10	440
10	220	6.3 x 7	E07	ULR227M1AE07	15	2700	10	440
10	220	6.3 x 8	E08	ULR227M1AE08	12	3200	10	440
10	270	8 x 8	F08	ULR277M1AF08	14	4420	10	540
10	270	8 x 11.5	F1A	ULR277M1AF1A	11	5100	10	540
10	330	6.3 x 8	E08	ULR337M1AE08	11	3500	10	660
10	330	8 x 8	F08	ULR337M1AF08	11	5000	10	660
10	330	8 x 11.5	F1A	ULR337M1AF1A	11	5100	10	660
10	390	8 x 8	F08	ULR397M1AF08	11	5000	10	780
10	390	8 x 11.5	F1A	ULR397M1AF1A	9	6100	10	780
10	470	6.3 x 8.5	E85	ULR477M1AE85	12	3500	10	940
10	470	6.3 x 11	E11	ULR477M1AE11	12	3750	10	940
10	470	8 x 8	F08	ULR477M1AF08	11	5000	10	940
10	470	8 x 11.5	F1A	ULR477M1AF1A	9	5650	10	940
10	470	10 x 12.5	G1B	ULR477M1AG1B	8	6100	10	940

Specifications are subject to change without notice. Should a safety or technical concern arise regarding the product, please be sure to contact our sales offices or agents immediately.

ULR Series

+105°C, Higher Ripple Current, Lower ESR than ULG

ULR Series

Rated Vol. (V)	Rated Cap. (µF)	Case Size ΦD x L (mm)	Size Code	Part Number	ESR (mΩ, max/ 20°C, 100kHz)	Rated Ripple (mA _{rms} / 105°C, 100kHz)	DF (%max)	Leakage Current (µA/2 mins)
10	560	8 x 8	F08	ULR567M1AF08	9	5600	10	1120
10	560	8 x 11.5	F1A	ULR567M1AF1A	9	5650	10	1120
10	680	8 x 11.5	F1A	ULR687M1AF1A	10	5800	10	1360
10	680	10 x 12.5	G1B	ULR687M1AG1B	8	6100	10	1360
10	820	8 x 11.5	F1A	ULR827M1AF1A	8	6100	10	1640
10	1000	8 x 11.5	F1A	ULR108M1AF1A	10	5200	10	2000
10	1000	10 x 12.5	G1B	ULR108M1AG1B	9	6100	10	2000
10	1200	10 x 12.5	G1B	ULR128M1AG1B	8	6200	10	2400
12	330	5 x 9	D09	ULR337M1OD09	12	2690	10	792
14	560	6.3 x 10	E10	ULR567M14E10	12	3800	10	1568
16	22	6.3 x 6	E06	ULR226M1CE06	80	1200	10	280
16	47	6.3 x 8	E08	ULR476M1CE08	60	1500	10	280
16	100	5 x 9	D09	ULR107M1CD09	24	2820	10	320
16	100	6.3 x 6	E06	ULR107M1CE06	25	2700	10	320
16	100	6.3 x 7	E07	ULR107M1CE07	24	2820	10	320
16	100	6.3 x 8	E08	ULR107M1CE08	24	2820	10	320
16	100	6.3 x 11	E11	ULR107M1CE11	24	2820	10	320
16	180	8 x 11.5	F1A	ULR187M1CF1A	13	5000	10	576
16	220	6.3 x 11	E11	ULR227M1CE11	20	3100	10	704
16	220	8 x 8	F08	ULR227M1CF08	13	4300	10	704
16	220	8 x 11.5	F1A	ULR227M1CF1A	13	5000	10	704
16	270	6.3 x 11	E11	ULR277M1CE11	20	3100	10	864
16	270	8 x 8	F08	ULR277M1CF08	13	4300	10	864
16	270	8 x 11.5	F1A	ULR277M1CF1A	13	5000	10	864
16	330	6.3 x 10.5	E1K	ULR337M1CE1K	18	3200	10	1056
16	330	6.3 x 11	E11	ULR337M1CE11	18	3200	10	1056
16	330	8 x 7	F07	ULR337M1CF07	13	4300	10	1056
16	330	8 x 8	F08	ULR337M1CF08	13	4300	10	1056
16	330	8 x 11.5	F1A	ULR337M1CF1A	10	5800	10	1056
16	330	10 x 9	G09	ULR337M1CG09	13	4300	10	1056
16	330	10 x 12.5	G1B	ULR337M1CG1B	10	6100	10	1056
16	470	8 x 11.5	F1A	ULR477M1CF1A	11	5100	10	1504
16	470	10 x 12.5	G1B	ULR477M1CG1B	10	6100	10	1504
16	680	8 x 11.5	F1A	ULR687M1CF1A	11	5100	10	2176
16	680	10 x 12.5	G1B	ULR687M1CG1B	10	6100	10	2176
16	820	10 x 12.5	G1B	ULR827M1CG1B	10	6100	10	2624
16	1000	8 x 16	F16	ULR108M1CF16	10	5950	10	3200
16	1000	10 x 12.5	G1B	ULR108M1CG1B	10	6100	10	3200
20	33	6.3 x 8	E08	ULR336M1DE08	35	2000	10	280
20	47	8 x 8	F08	ULR476M1DF08	33	2100	10	280
20	100	8 x 11.5	F1A	ULR107M1DF1A	32	2750	10	400
20	150	10 x 12.5	G1B	ULR157M1DG1B	28	2900	10	600
25	22	6.3 x 8	E08	ULR226M1EE08	45	1870	10	280
25	33	8 x 8	F08	ULR336M1EF08	40	2050	10	280
25	47	8 x 8	F08	ULR476M1EF08	36	2100	10	280
25	100	8 x 11.5	F1A	ULR107M1EF1A	32	2750	10	500
25	220	8 x 11.5	F1A	ULR227M1EF1A	32	2750	10	1100
25	330	8 x 11.5	F1A	ULR337M1EF1A	32	2750	10	1650
25	330	10 x 12.5	G1B	ULR337M1EG1B	45	2700	10	1650
25	680	8 x 16	F16	ULR687M1EF16	16	4700	10	3400
25	1000	10 x 16	G16	ULR108M1EG16	10	6100	10	5000
35	100	8 x 11.5	F1A	ULR107M1VF1A	55	2000	10	700
35	100	10 x 12.5	G1B	ULR107M1VG1B	60	2000	10	700
35	220	10 x 12.5	G1B	ULR227M1VG1B	50	2500	10	1540

Specifications are subject to change without notice. Should a safety or technical concern arise regarding the product, please be sure to contact our sales offices or agents immediately.

UER Series

+105°C, Higher Ripple Current, Long Life 5,000 Hours

Features

- Higher Ripple Current, Long Life 5,000 Hours
- Wide Temperature Range
- RoHS Compliant

Applications

- Suitable for DC-DC Converters, Voltage Regulators, Decoupling Applications for Computer Motherboards, etc.



Specifications

Item	Performance Characteristics				
Operating Temperature Range	-55 to +105°C				
Rated Working Voltage Range	2.5VDC to 35VDC				
Surge Voltage, SV	SV=WVx1.15VDC (Normal temperature)				
Nominal Capacitance Range	100 to 2500μF (120Hz, +20°C)				
Capacitance Tolerance	±20% (120Hz, +20°C)				
tan δ	0.10 (120Hz, +20°C)				
Leakage Current, Lc	I≤0.2CV or 280 (μA) whichever is greater measured, after 2 minutes application of rated working voltage at +20°C				
Temperature Characteristics, Impedance Ratio	At -55°C 100kHz (Low temperature)			Z/Z20°C≤1.25	
	At +105°C 100kHz (High temperature)			Z/Z20°C≤1.25	
Frequency Coefficient for Allowable Ripple Current	Frequency	120Hz≤f<1kHz	1kHz≤f<10kHz	10kHz≤f<100kHz	100kHz≤f<500kHz
	Coefficient	0.05	0.30	0.70	1.00
Endurance	Test conditions +105°C, 5,000 hours Rated voltage applied	ΔC/C	Within ±20% of the initial measured value		
		tan δ	≤150% of the initial specified value		
		ESR	≤150% of the initial specified value		
		Lc	≤The initial specified value		
Damp Heat Test (Steady State)	Test conditions +60°C, 90% to 95% RH 1,000 hours No applied voltage	ΔC/C	Within ±20% of the initial measured value		
		tan δ	≤150% of the initial specified value		
		ESR	≤150% of the initial specified value		
		Lc	≤The initial specified value		
Surge Voltage Test	At normal temperature, charge at surge voltage for 30 sec. and discharge via a 1kΩ protective resistor for 330 sec. Repeat for 1,000 cycles.	ΔC/C	Within ±20% of the initial measured value		
		tan δ	≤150% of the initial specified value		
		ESR	≤150% of the initial specified value		
		Lc	≤The initial specified value		
Others	JIS-C-5101-4				

Dimensions

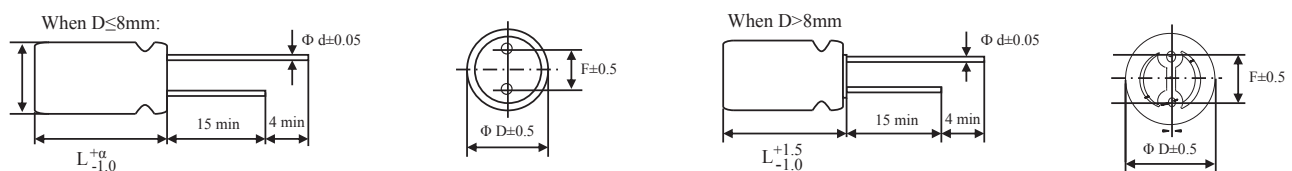

UER Series

+105°C, Higher Ripple Current, Long Life 5,000 Hours

Size List

 New Item | RV: Rated Voltage

RV μF	Code	2.5 (0E)	4 (0G)	6.3 (0J)	7.5 (07)	10 (1A)	16 (1C)	20 (1D)	25 (1E)	35V (1V)
100	107			E06			E05, E07, E08		F1A ^(N)	
120	127									G1B ^(N)
220	227						F1A		F1A ^(N)	
270	277						E08 ^(N) , F08, F1A			
330	337				D09 ^(N)		F1A		F1A ^(N) , G1B ^(N)	
390	397							F1A ^(N)		
470	477	E08		E08, F08			F1A, G1B		F1A ^(N)	
500	507				D09 ^(N)					
560	567	D08 ^(N) , D09	E08	E08, F08				G1B ^(N)		
680	687			E75, E11 ^(N)						
820	827	E08, F08		E85 ^(N) , F08 ^(N)	E10 ^(N)					
1000	108			F1A ^(N)			G1B		G16 ^(N)	
1200	128					G1B				
1500	158			F1A ^(N)			G16 ^(N)			
2500	258			G1B ^(N)						

(Unit: mm)

Size Code	D08	D09	E05	E06	E07	E75	E08
ΦDxL	5 x 8	5 x 9	6.3 x 5	6.3 x 6	6.3 x 7	6.3 x 7.5	6.3 x 8
F±0.5	2.0	2.0	2.5	2.5	2.5	2.5	2.5
Φd	0.6	0.6	0.45	0.45	0.5	0.5	0.6
α	1.0	1.0	1.0	1.0	1.0	1.0	1.0

Size Code	E85	E10	E11	F08	F1A	G1B	G16
ΦDxL	6.3 x 8.5	6.3 x 10	6.3 x 11	8 x 8	8 x 11.5	10 x 12.5	10 x 16
F±0.5	2.5	2.5	2.5	3.5	3.5	5.0	5.0
Φd	0.6	0.6	0.6	0.6	0.6	0.6	0.6
α	1.0	1.0	1.5	1.0	1.5	1.5	1.5

Specifications are subject to change without notice. Should a safety or technical concern arise regarding the product, please be sure to contact our sales offices or agents immediately.

UER Series

+105°C, Higher Ripple Current, Long Life 5,000 Hours

Characteristics List

Rated Vol. (V)	Rated Cap. (μF)	Case Size ΦD x L (mm)	Size Code	Part Number	ESR (mΩ, max/ 20°C, 100kHz)	Rated Ripple (mArms/ 105°C, 100kHz)	DF (%max)	Leakage Current (μA/2 mins)
2.5	470	6.3 x 8	E08	UER477M0EE08	10	4500	10	280
2.5	560	5 x 8	D08	UER567M0ED08	7	4300	10	280
2.5	560	5 x 9	D09	UER567M0ED09	7	4350	10	280
2.5	820	6.3 x 8	E08	UER827M0EE08	7	5600	10	410
2.5	820	8 x 8	F08	UER827M0EF08	7	5600	10	410
4	560	6.3 x 8	E08	UER567M0GE08	7	4500	10	448
6.3	100	6.3 x 6	E06	UER107M0JE06	30	2580	10	280
6.3	470	6.3 x 8	E08	UER477M0JE08	10	4500	10	592
6.3	470	8 x 8	F08	UER477M0JF08	8	4000	10	592
6.3	560	6.3 x 8	E08	UER567M0JE08	8	4700	10	706
6.3	560	8 x 8	F08	UER567M0JF08	8	4800	10	706
6.3	680	6.3 x 7.5	E75	UER687M0JE75	8	4800	10	857
6.3	680	6.3 x 11	E11	UER687M0JE11	8	4950	10	857
6.3	820	6.3 x 8.5	E85	UER827M0JE85	8	4800	10	1033
6.3	820	8 x 8	F08	UER827M0JF08	8	4850	10	1033
6.3	1000	8 x 11.5	F1A	UER108M0JF1A	8	4900	10	1260
6.3	1500	8 x 11.5	F1A	UER158M0JF1A	8	4900	10	1890
6.3	2500	10 x 12.5	G1B	UER258M0JG1B	7	6100	10	3150
7.5	330	5 x 9	D09	UER337M07D09	12	3100	10	495
7.5	500	5 x 9	D09	UER507M07D09	12	3100	10	750
7.5	820	6.3 x 10	E10	UER827M07E10	10	4200	10	1230
10	1200	10 x 12.5	G1B	UER128M1AG1B	8	5000	10	2400
16	100	6.3 x 5	E05	UER107M1CE05	24	2490	10	320
16	100	6.3 x 7	E07	UER107M1CE07	24	2490	10	320
16	100	6.3 x 8	E08	UER107M1CE08	24	2820	10	320
16	220	8 x 11.5	F1A	UER227M1CF1A	15	4300	10	704
16	270	6.3 x 8	E08	UER277M1CE08	15	3800	10	864
16	270	8 x 8	F08	UER277M1CF08	12	5000	10	864
16	270	8 x 11.5	F1A	UER277M1CF1A	10	5000	10	864
16	330	8 x 11.5	F1A	UER337M1CF1A	10	5000	10	1056
16	470	8 x 11.5	F1A	UER477M1CF1A	11	5400	10	1504
16	470	10 x 12.5	G1B	UER477M1CG1B	11	5600	10	1504
16	1000	10 x 12.5	G1B	UER108M1CG1B	11	5600	10	3200
16	1500	10 x 16	G16	UER158M1CG16	10	6100	10	4800
20	390	8 x 11.5	F1A	UER397M1DF1A	18	4520	10	1560
20	560	10 x 12.5	G1B	UER567M1DG1B	30	3350	10	2240
25	100	8 x 11.5	F1A	UER107M1EF1A	38	2600	10	500
25	220	8 x 11.5	F1A	UER227M1EF1A	38	2600	10	1100
25	330	8 x 11.5	F1A	UER337M1EF1A	35	3100	10	1650
25	330	10 x 12.5	G1B	UER337M1EG1B	35	2750	10	1650
25	470	8 x 11.5	F1A	UER477M1EF1A	35	2750	10	2350
25	1000	10 x 16	G16	UER108M1EG16	20	5050	10	5000
35	120	10 x 12.5	G1B	UER127M1VG1B	40	3030	10	840

Specifications are subject to change without notice. Should a safety or technical concern arise regarding the product, please be sure to contact our sales offices or agents immediately.

UPG Series

+105°C, High Voltage, Low ESR

Features

- High Voltage, Low ESR
- Wide Temperature Range
- RoHS Compliant

Applications

- Suitable for DC-DC Converters, Voltage Regulators, Decoupling Applications for Computer Motherboards, etc.



Specifications

Item	Performance Characteristics				
Operating Temperature Range	-55 to +105°C				
Rated Working Voltage Range	50VDC to 200VDC				
Surge Voltage, SV	SV=WVx1.15VDC (Normal temperature)				
Nominal Capacitance Range	1 to 120μF (120Hz, +20°C)				
Capacitance Tolerance	±20% (120Hz, +20°C)				
tan δ	0.12 (120Hz, +20°C)				
Leakage Current, Lc	I ≤ 0.2CV or 280 (μA) whichever is greater measured, after 2 minutes application of rated working voltage at +20°C				
Temperature Characteristics, Impedance Ratio	At -55°C 100kHz (Low temperature)			Z/Z20°C ≤ 1.25	
	At +105°C 100kHz (High temperature)			Z/Z20°C ≤ 1.25	
Frequency Coefficient for Allowable Ripple Current	Frequency	120Hz ≤ f < 1kHz	1kHz ≤ f < 10kHz	10kHz ≤ f < 100kHz	100kHz ≤ f < 500kHz
	Coefficient	0.05	0.30	0.70	1.00
Endurance	Test conditions +105°C, 2,000 hours Rated voltage applied	ΔC/C	Within ±20% of the initial measured value		
		tan δ	≤ 150% of the initial specified value		
		ESR	≤ 150% of the initial specified value		
		Lc	≤ The initial specified value		
Damp Heat Test (Steady State)	Test conditions +60°C, 90% to 95% RH 1,000 hours No applied voltage	ΔC/C	Within ±20% of the initial measured value		
		tan δ	≤ 150% of the initial specified value		
		ESR	≤ 150% of the initial specified value		
		Lc	≤ The initial specified value		
Surge Voltage Test	At normal temperature, charge at surge voltage for 30 sec. and discharge via a 1kΩ protective resistor for 330 sec. Repeat for 1,000 cycles.	ΔC/C	Within ±20% of the initial measured value		
		tan δ	≤ 150% of the initial specified value		
		ESR	≤ 150% of the initial specified value		
		Lc	≤ The initial specified value		
Others	JIS-C-5101-4				

Dimensions

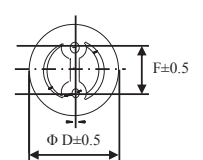
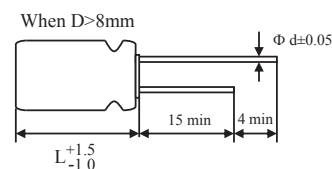
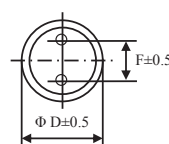
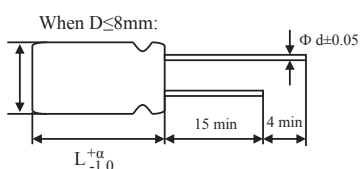

UPG Series

+105°C, High Voltage, Low ESR

Size List

 New Item | RV: Rated Voltage

μF \ RV	Code	50 (1H)	63 (1J)	80 (1K)	100 (2A)	200 (2D)
1	105					E08
3.3	335			E06 ^①		F08
4.7	475					F1A
6.8	685				F1A	G1B
8.2	825					G1B
10	106	D08 ^① , E06 ^①	E11 ^①		E11 ^① , F1A	
18	186				G1B	
22	226	F08	F08		G1B ^①	
33	336	F08	F08		G1B ^①	
47	476	F1A	G1B			
56	566	G1B	G1B			
68	686	G1B				
100	107	G1B				
120	127	G1B				

(Unit: mm)

Size Code	D08	E06	E08	E11	F08	F1A	G1B
$\Phi\text{D} \times \text{L}$	5 x 8	6.3 x 6	6.3 x 8	6.3 x 11	8 x 8	8 x 11.5	10 x 12.5
$F \pm 0.5$	2.0	2.5	2.5	2.5	3.5	3.5	5.0
Φd	0.6	0.45	0.6	0.6	0.6	0.6	0.6
α	1.0	1.0	1.0	1.5	1.0	1.5	1.5

Specifications are subject to change without notice. Should a safety or technical concern arise regarding the product, please be sure to contact our sales offices or agents immediately.

UPG Series

+105°C, High Voltage, Low ESR

Characteristics List

Rated Vol. (V)	Rated Cap. (μF)	Case Size ΦD x L (mm)	Size Code	Part Number	ESR (mΩ, max/ 20°C, 100kHz)	Rated Ripple (mArms/ 105°C, 100kHz)	DF (%max)	Leakage Current (μA/2 mins)
50	10	5 x 8	D08	UPG106M1HD08	80	790	12	280
50	10	6.3 x 6	E06	UPG106M1HE06	200	547	12	280
50	22	8 x 8	F08	UPG226M1HF08	45	1300	12	280
50	33	8 x 8	F08	UPG336M1HF08	45	1300	12	330
50	47	8 x 11.5	F1A	UPG476M1HF1A	42	1500	12	470
50	56	10 x 12.5	G1B	UPG566M1HG1B	38	2000	12	560
50	68	10 x 12.5	G1B	UPG686M1HG1B	35	2100	12	680
50	100	10 x 12.5	G1B	UPG107M1HG1B	35	2100	12	1000
50	120	10 x 12.5	G1B	UPG127M1HG1B	35	2100	12	1200
63	10	6.3 x 11	E11	UPG106M1JE11	90	850	12	280
63	22	8 x 8	F08	UPG226M1JF08	65	1100	12	280
63	33	8 x 8	F08	UPG336M1JF08	65	1100	12	416
63	47	10 x 12.5	G1B	UPG476M1JG1B	60	1300	12	592
63	56	10 x 12.5	G1B	UPG566M1JG1B	55	1500	12	706
80	3.3	6.3 x 6	E06	UPG335M1KE06	300	350	12	280
100	6.8	8 x 11.5	F1A	UPG685M2AF1A	45	1600	12	280
100	10	6.3 x 11	E11	UPG106M2AE11	90	1650	12	280
100	10	8 x 11.5	F1A	UPG106M2AF1A	42	1800	12	280
100	18	10 x 12.5	G1B	UPG186M2AG1B	38	2200	12	300
100	22	10 x 12.5	G1B	UPG226M2AG1B	38	2200	12	440
100	33	10 x 12.5	G1B	UPG336M2AG1B	65	1550	12	660
200	1	6.3 x 8	E08	UPG105M2DE08	2000	150	12	280
200	3.3	8 x 8	F08	UPG335M2DF08	500	300	12	280
200	4.7	8 x 11.5	F1A	UPG475M2DF1A	400	350	12	280
200	6.8	10 x 12.5	G1B	UPG685M2DG1B	300	500	12	280
200	8.2	10 x 12.5	G1B	UPG825M2DG1B	300	595	12	328

Specifications are subject to change without notice. Should a safety or technical concern arise regarding the product, please be sure to contact our sales offices or agents immediately.

UBR Series

+125°C, High Temperature, Low ESR

Features

- High Temperature
- Low ESR
- RoHS Compliant

Applications

- Suitable for DC-DC Converters, Voltage Regulators, Decoupling Applications for Computer Motherboards, etc.

Specifications



Item	Performance Characteristics				
Operating Temperature Range	-55 to +125°C				
Rated Working Voltage Range	2.5VDC to 100VDC				
Surge Voltage, SV	SV=WVx1.15VDC (Normal temperature)				
Nominal Capacitance Range	10 to 1200μF (120Hz, +20°C)				
Capacitance Tolerance	±20% (120Hz, +20°C)				
tan δ	0.12 (120Hz, +20°C)				
Leakage Current, Lc	I≤0.2CV or 280 (μA) whichever is greater measured, after 2 minutes application of rated working voltage at +20°C				
Temperature Characteristics, Impedance Ratio	At -55°C 100kHz (Low temperature)			Z/Z20°C≤1.25	
	At +125°C 100kHz (High temperature)			Z/Z20°C≤1.25	
Frequency Coefficient for Allowable Ripple Current	Frequency	120Hz≤f<1kHz	1kHz≤f<10kHz	10kHz≤f<100kHz	100kHz≤f<500kHz
	Coefficient	0.05	0.30	0.70	1.00
Endurance	Test conditions +125°C, 1,000 hours Rated voltage applied	ΔC/C	Within ±20% of the initial measured value		
		tan δ	≤200% of the initial specified value		
		ESR	≤200% of the initial specified value		
		Lc	≤The Initial specified value		
Damp Heat Test (Steady State)	Test conditions +60°C, 90% to 95% RH 1,000 hours No applied voltage	ΔC/C	Within ±20% of the initial measured value		
		tan δ	≤150% of the initial specified value		
		ESR	≤150% of the initial specified value		
		Lc	≤The initial specified value		
Surge Voltage Test	At normal temperature, charge at surge voltage for 30 sec. and discharge via a 1kΩ protective resistor for 330 sec. Repeat for 1,000 cycles.	ΔC/C	Within ±20% of the initial measured value		
		tan δ	≤150% of the initial specified value		
		ESR	≤150% of the initial specified value		
		Lc	≤The initial specified value		
Others	JIS-C-5101-4				

Dimensions

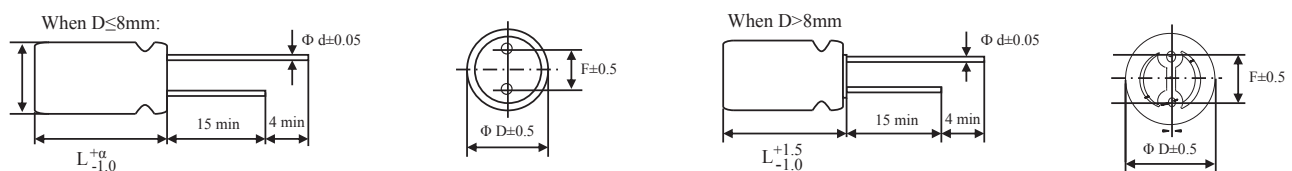

UBR Series

+125°C, High Temperature, Low ESR

Size List

 New Item | RV: Rated Voltage

RV μF	Code	2.5 (0E)	4 (0G)	6.3 (0J)	10 (1V)	16 (1C)	20 (1D)	25 (1E)	35 (1V)	63 (1J)	100 (2A)
10	827								E08 [Ⓔ]	E11 [Ⓔ]	E11 [Ⓔ]
47	476								F08		
100	107					E11			F1A [Ⓔ]		
180	187							F1A			
220	227					F08		F1A	G1B		
270	277					F1A [Ⓔ]		F1A			
470	477					G1B [Ⓔ]					
560	567			F08			G1B [Ⓔ]				
820	827	E08		E85 [Ⓔ] , E11 [Ⓔ] , F08 [Ⓔ]	F1A [Ⓔ]						
1200	128	F1A	G1B								

(Unit: mm)

Size Code	E08	E85	E11	F08	F1A	G1B
ΦDxL	6.3 x 8	6.3 x 8.5	6.3 x 11	8 x 8	8 x 11.5	10 x 12.5
F±0.5	2.5	2.5	2.5	3.5	3.5	5.0
Φd	0.6	0.6	0.6	0.6	0.6	0.6
α	1.0	1.0	1.5	1.0	1.5	1.5

Characteristics List

Rated Vol. (V)	Rated Cap. (μF)	Case Size ΦD x L (mm)	Size Code	Part Number	ESR (mΩ, max/ 20°C, 100kHz)	Rated Ripple (mArms/ 125°C, 100kHz)	Rated Ripple (mArms/ 105°C, 100kHz)	DF (%max)	Leakage Current (μA/2 mins)
2.5	820	6.3 x 8	E08	UBR827M0EE08	12	1680	5600	12	410
2.5	1200	8 x 11.5	F1A	UBR128M0EF1A	10	1830	6100	12	600
4	1200	10 x 12.5	G1B	UBR128M0GG1B	10	1830	6100	12	960
6.3	560	8 x 8	F08	UBR567M0JF08	12	1710	5700	12	706
6.3	820	6.3 x 8.5	E85	UBR827M0JE85	12	1180	3950	12	1033
6.3	820	6.3 x 11	E11	UBR827M0JE11	10	1560	5200	12	1033
6.3	820	8 x 8	F08	UBR827M0JF08	12	1500	5000	12	1033
10	820	8 x 11.5	F1A	UBR827M1AF1A	12	1530	5100	12	1640
16	100	6.3 x 11	E11	UBR107M1CE11	24	846	2820	12	320
16	220	8 x 8	F08	UBR227M1CF08	13	1290	4300	12	704
16	270	8 x 11.5	F1A	UBR277M1CF1A	13	1500	5000	12	864
16	470	10 x 12.5	G1B	UBR477M1CG1B	10	1800	6000	12	1504
20	560	10 x 12.5	G1B	UBR567M1DG1B	30	1000	3350	12	2240
25	180	8 x 11.5	F1A	UBR187M1EF1A	35	825	2750	12	900
25	220	8 x 11.5	F1A	UBR227M1EF1A	40	600	2000	12	1100
25	270	8 x 11.5	F1A	UBR277M1EF1A	40	600	2000	12	1350
35	10	6.3 x 8	E08	UBR106M1VE08	90	450	1500	12	280
35	47	8 x 8	F08	UBR476M1VF08	90	360	1200	12	329
35	100	8 x 11.5	F1A	UBR107M1VF1A	70	540	1800	12	700
35	220	10 x 12.5	G1B	UBR227M1VG1B	55	735	2450	12	1540
63	10	6.3 x 11	E11	UBR106M1JE11	90	490	1650	12	280
100	10	6.3 x 11	E11	UBR106M2AE11	90	490	1650	12	280

Specifications are subject to change without notice. Should a safety or technical concern arise regarding the product, please be sure to contact our sales offices or agents immediately.

UVG Series

+105°C, Surface Mount Type, Low ESR

Features

- Standard SMD Type Product
- Support Lead Free Reflow
- RoHS Compliant

Applications

- Suitable for DC-DC Converters, Voltage Regulators, Decoupling Applications for Computer Motherboards, etc.

Specifications



Item	Performance Characteristics				
Operating Temperature Range	-55 to +105°C				
Rated Working Voltage Range	2.5VDC to 25VDC				
Surge Voltage, SV	SV=WV x 1.15VDC (Normal temperature)				
Nominal Capacitance Range	10 to 820μF (120Hz, +20°C)				
Capacitance Tolerance	±20% (120Hz, +20°C)				
tan δ	0.15 (120Hz, +20°C)				
Leakage Current, Lc	After 2 minutes of rated voltage applied at +20°C, please see the characteristics list				
Temperature Characteristics, Impedance Ratio	At -55°C 100kHz (Low temperature)			Z/Z20°C ≤ 1.25	
	At +105°C 100kHz (High temperature)			Z/Z20°C ≤ 1.25	
Frequency Coefficient for Allowable Ripple Current	Frequency	120Hz ≤ f < 1kHz	1kHz ≤ f < 10kHz	10kHz ≤ f < 100kHz	100kHz ≤ f < 500kHz
	Coefficient	0.05	0.30	0.70	1.00
Endurance	Test conditions +105°C, 2,000 hours Rated voltage applied	ΔC/C	Within ±20% of the initial measured value		
		tan δ	≤ 150% of the initial specified value		
		ESR	≤ 150% of the initial specified value		
		Lc	≤ The initial specified value		
Damp Heat Test (Steady State)	Test conditions +60°C, 90% to 95% RH 1,000 hours No applied voltage	ΔC/C	Within ±20% of the initial measured value		
		tan δ	≤ 150% of the initial specified value		
		ESR	≤ 150% of the initial specified value		
		Lc	≤ The initial specified value		
Resistance to Soldering Heat	+230°C, 75 sec.	ΔC/C	Within ±20% of the initial measured value		
		tan δ	≤ 150% of the initial specified value		
		ESR	≤ 150% of the initial specified value		
		Lc	≤ The initial specified value		
Others	JIS-C-5101-18				

UVG Series

+105°C, Surface Mount Type, Low ESR

Case Size Table

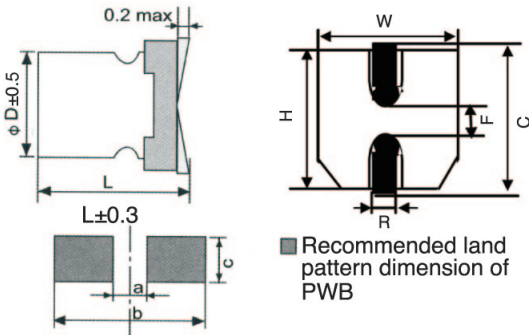

(Unit: mm)

Size Code	D06	E06	F08	FT2	F12	G1B
ΦD x L	5 x 6	6.3 x 6	8 x 8	8 x 10.2	8 x 12	10 x 12.5
W±0.2	5.3	6.6	8.3	8.3	8.3	10.3
H±0.2	5.3	6.6	8.3	8.3	8.3	10.3
C±0.2	6	7.3	9.0	9.0	9.0	11
R	0.5~0.8	0.5~0.8	0.6~1.0	0.8~1.1	0.8~1.1	0.8~1.1
F±0.2	1.7	1.9	3.2	3.2	3.2	4.6
a	2.1	2.1	2.8	2.8	2.8	4.3
b	7.7	9.1	11.1	11.1	11.1	13.1
c	1.6	1.6	1.9	1.9	1.9	1.9

Size List

New Item | RV: Rated Voltage

RV μF	Code	2.5 (0E)	4 (0G)	6.3 (0J)	10 (1A)	16 (1C)	20 (1D)	25 (E)
10	106						D06 ^(N)	E06 ^(N)
22	226						E06	
47	476						F08	E06, FT2
100	107						F12	F12
150	157							G1B ^(N)
180	187					F12		
220	227							G1B ^(N)
270	277					F12 ^(N)		
330	337	E06	E06		F12			
470	477			F12				
560	567	FT2	F12		F12			
680	687	F12						
820	827			F12				

Specifications are subject to change without notice. Should a safety or technical concern arise regarding the product, please be sure to contact our sales offices or agents immediately.

UVG Series

+105°C, Surface Mount Type, Low ESR

Characteristics List

Rated Vol. (V)	Rated Cap. (μF)	Case Size ΦD x L (mm)	Size Code	Part Number	ESR (mΩ, max/ 20°C, 100kHz)	Rated Ripple (mArms/ 105°C, 100kHz)	DF (%max)	Leakage Current (μA/2 mins)
2.5	330	6.3 x 6	E06	UVG337M0EE06	26	2247	15	500
2.5	560	8 x 10.2	FT2	UVG567M0EFT2	15	4210	15	500
2.5	680	8 x 12	F12	UVG687M0EF12	13	4520	15	500
4	330	6.3 x 6	E06	UVG337M0GE06	21	2630	15	500
4	560	8 x 12	F12	UVG567M0GF12	15	4000	15	500
6.3	470	8 x 12	F12	UVG477M0JF12	15	4210	15	592
6.3	820	8 x 12	F12	UVG827M0JF12	15	4210	15	1033
10	330	8 x 12	F12	UVG337M1AF12	17	3950	15	660
10	560	8 x 12	F12	UVG567M1AF12	17	3950	15	1120
16	180	8 x 12	F12	UVG187M1CF12	20	3640	15	576
16	270	8 x 12	F12	UVG277M1CF12	19	4070	15	864
20	10	5 x 6	D06	UVG106M1DD06	120	1000	15	500
20	22	6.3 x 6	E06	UVG226M1DE06	60	1650	15	500
20	47	8 x 8	F08	UVG476M1DF08	45	1890	15	500
20	100	8 x 12	F12	UVG107M1DF12	30	2960	15	500
25	10	6.3 x 6	E06	UVG106M1EE06	70	1600	15	500
25	47	6.3 x 6	E06	UVG476M1EE06	70	1600	15	500
25	47	8 x 10.2	FT2	UVG476M1EFT2	45	2000	15	500
25	100	8 x 12	F12	UVG107M1EF12	40	2500	15	500
25	150	10 x 12.5	G1B	UVG157M1EG1B	35	3050	15	750
25	220	10 x 12.5	G1B	UVG227M1EG1B	35	3050	15	1100

Specifications are subject to change without notice. Should a safety or technical concern arise regarding the product, please be sure to contact our sales offices or agents immediately.

UVR Series

+105°C, Surface Mount Type, Lower ESR than UVG

Features

- Surface Mount Type Product with Large Capacitance and Low ESR
- Support Lead Free Reflow
- RoHS Compliant



Applications

- Suitable for DC-DC Converters, Voltage Regulators, Decoupling Applications for Computer Motherboards and High End Graphic Card, etc..

Specifications

Item	Performance Characteristics				
Operating Temperature Range	-55 to +105°C				
Rated Working Voltage Range	2.5VDC to 16VDC				
Surge Voltage, SV	SV=WVx1.15VDC (Normal temperature)				
Nominal Capacitance Range	39 to 2200μF (120Hz, +20°C)				
Capacitance Tolerance	±20% (120Hz, +20°C)				
tan δ	0.12 (120Hz, +20°C)				
Leakage Current, Lc	After 2 minutes of rated voltage applied at +20°C, please see the characteristics list				
Temperature Characteristics, Impedance Ratio	At -55°C 100kHz (Low temperature)			Z/Z20°C≤1.25	
	At +105°C 100kHz (High temperature)			Z/Z20°C≤1.25	
Frequency Coefficient for Allowable Ripple Current	Frequency	120Hz≤f<1kHz	1kHz≤f<10kHz	10kHz≤f<100kHz	100kHz≤f<500kHz
	Coefficient	0.05	0.30	0.70	1.00
Endurance	Test conditions +105°C, 2,000 hours Rated voltage applied	ΔC/C	Within ±20% of the initial measured value		
		tan δ	≤150% of the initial specified value		
		ESR	≤150% of the initial specified value		
		Lc	≤The initial specified value		
Damp Heat Test (Steady State)	Test conditions +60°C, 90% to 95% RH 1,000 hours No applied voltage	ΔC/C	Within ±20% of the initial measured value		
		tan δ	≤150% of the initial specified value		
		ESR	≤150% of the initial specified value		
		Lc	≤The initial specified value		
Resistance to Soldering Heat	+230°C, 75 sec.	ΔC/C	Within ±20% of the initial measured value		
		tan δ	≤150% of the initial specified value		
		ESR	≤150% of the initial specified value		
		Lc	≤The initial specified value		
Others	JIS-C-5101-18				

UVR Series

+105°C, Surface Mount Type, Lower ESR than UVG

Case Size Table

(Unit: mm)

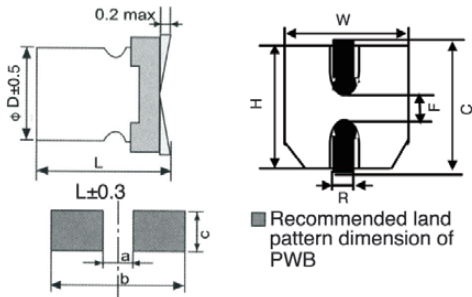

Size Code	E42	E45	E59	E06	E08	E09	F08	FT2	F12	G1B
ΦDxL	6.3 x 4.2	6.3 x 4.5	6.3 x 5.9	6.3 x 6	6.3 x 8	6.3 x 9	8 x 8	8 x 10.2	8 x 12	10 x 12.5
W±0.2	6.6	6.6	6.6	6.6	6.6	6.6	8.3	8.3	8.3	10.3
H±0.2	6.6	6.6	6.6	6.6	6.6	6.6	8.3	8.3	8.3	10.3
C±0.2	7.3	7.3	7.3	7.3	7.3	7.3	9.0	9.0	9.0	11
R	0.5-0.8	0.5-0.8	0.5-0.8	0.5-0.8	0.5-0.8	0.5-0.8	0.6-1.0	0.8-1.1	0.8-1.1	0.8-1.1
F±0.2	1.9	1.9	1.9	1.9	1.9	1.9	3.2	3.2	3.2	4.6
a	2.1	2.1	2.1	2.1	2.1	2.1	2.8	2.8	2.8	4.3
b	9.1	9.1	9.1	9.1	9.1	9.1	11.1	11.1	11.1	13.1
c	1.6	1.6	1.6	1.6	1.6	1.6	1.9	1.9	1.9	1.9

Size List

New Item | RV: Rated Voltage

RV μF	Code	2.5 (0E)	4 (0G)	6.3 (0J)	10 (1A)	16 (1C)
39	396					E06
47	476			E06 ^(N)	E06	
68	686					E06
100	107			E06		E06
120	127				E06	
150	157			E06	E06	F08
180	187					F12
220	270			E42 ^(N) , E45 ^(N) , E59		F08, FT2, F12
270	277					FT2, F12
330	337	E42 ^(N) , E45 ^(N) , E06	E06	E59, E08	F12	F12, G1B
390	397	E06				
470	477			E09, F12	F12	F12, G1B
560	567	E06, FT2	FT2, F12	F08, F12		
680	687	F12	F08	G1B		G1B ^(N)
820	827	FT2		F12, G1B		
1000	108	F08	G1B	F12		
1500	158			G1B		
2200	228			G1B ^(N)		

Characteristics List

Rated Vol. (V)	Rated Cap. (μF)	Case Size ΦD x L (mm)	Size Code	Part Number	ESR (mΩ, max/ 20°C, 100kHz)	Rated Ripple (mArms/ 105°C, 100kHz)	DF (%max)	Leakage Current (μA/2 mins)
2.5	330	6.3 x 4.2	E42	UVR337M0EE42	17	2300	12	700
2.5	330	6.3 x 4.5	E45	UVR337M0EE45	17	2300	12	700
2.5	330	6.3 x 6	E06	UVR337M0EE06	17	2900	12	500
2.5	390	6.3 x 6	E06	UVR397M0EE06	17	3390	12	500
2.5	560	6.3 x 6	E06	UVR567M0EE06	16	3500	12	500
2.5	560	8 x 10.2	FT2	UVR567M0EFT2	12	4210	12	500

Specifications are subject to change without notice. Should a safety or technical concern arise regarding the product, please be sure to contact our sales offices or agents immediately.

UVR Series

+105°C, Surface Mount Type, Lower ESR than UVG

Rated Vol. (V)	Rated Cap. (μF)	Case Size ΦD x L (mm)	Size Code	Part Number	ESR (mΩ, max/ 20°C, 100kHz)	Rated Ripple (mArms/ 105°C, 100kHz)	DF (%max)	Leakage Current (μA/2 mins)
2.5	680	8 x 12	F12	UVR687M0EF12	10	5020	12	500
2.5	820	8 x 10.2	FT2	UVR827M0EFT2	12	4210	12	500
2.5	1000	8 x 8	F08	UVR108M0EF08	12	4260	12	500
4	330	6.3 x 6	E06	UVR337M0GE06	17	2900	12	500
4	560	8 x 10.2	FT2	UVR567M0GFT2	14	3950	12	544
4	560	8 x 12	F12	UVR567M0GF12	13	4520	12	500
4	680	8 x 8	F08	UVR687M0GF08	13	3950	12	544
4	1000	10 x 12.5	G1B	UVR108M0GG1B	10	4850	12	800
6.3	47	6.3 x 6	E06	UVR476M0JE06	70	1600	12	500
6.3	100	6.3 x 6	E06	UVR107M0JE06	50	1620	12	500
6.3	150	6.3 x 6	E06	UVR157M0JE06	50	1620	12	500
6.3	220	6.3 x 4.2	E42	UVR227M0JE42	24	2100	12	700
6.3	220	6.3 x 4.5	E45	UVR227M0JE45	24	2100	12	700
6.3	220	6.3 x 5.9	E59	UVR227M0JE59	26	2450	12	500
6.3	330	6.3 x 5.9	E59	UVR337M0JE59	25	2200	12	500
6.3	330	6.3 x 8	E08	UVR337M0JE08	15	2700	12	500
6.3	470	6.3 x 9	E09	UVR477M0JE09	15	2700	12	592
6.3	470	8 x 12	F12	UVR477M0JF12	12	4780	12	592
6.3	560	8 x 8	F08	UVR567M0JF08	20	2500	12	706
6.3	560	8 x 12	F12	UVR567M0JF12	12	4780	12	706
6.3	680	10 x 12.5	G1B	UVR687M0JG1B	15	3500	12	857
6.3	820	8 x 12	F12	UVR827M0JF12	12	4260	12	1033
6.3	820	10 x 12.5	G1B	UVR827M0JG1B	12	4500	12	1033
6.3	1000	8 x 12	F12	UVR108M0JF12	15	3500	12	1260
6.3	1500	10 x 12.5	G1B	UVR158M0JG1B	10	4850	12	1890
6.3	2200	10 x 12.5	G1B	UVR228M0JG1B	12	5250	12	2772
10	47	6.3 x 6	E06	UVR476M1AE06	50	1620	12	500
10	120	6.3 x 6	E06	UVR127M1AE06	25	2320	12	500
10	150	6.3 x 6	E06	UVR157M1AE06	27	2320	12	500
10	330	8 x 12	F12	UVR337M1AF12	14	4390	12	660
10	470	8 x 12	F12	UVR477M1AF12	25	3500	12	940
16	39	6.3 x 6	E06	UVR396M1CE06	50	1620	12	500
16	68	6.3 x 6	E06	UVR686M1CE06	30	2200	12	500
16	100	6.3 x 6	E06	UVR107M1CE06	25	2700	12	500
16	150	8 x 8	F08	UVR157M1CF08	22	3150	12	500
16	180	8 x 12	F12	UVR187M1CF12	16	4040	12	576
16	220	8 x 8	F08	UVR227M1CF08	22	3150	12	704
16	220	8 x 10.2	FT2	UVR227M1CFT2	22	3450	12	704
16	220	8 x 12	F12	UVR227M1CF12	22	3450	12	704
16	270	8 x 10.2	FT2	UVR277M1CFT2	20	3600	12	864
16	270	8 x 12	F12	UVR277M1CF12	13	5200	12	864
16	330	8 x 12	F12	UVR337M1CF12	16	4720	12	1056
16	330	10 x 12.5	G1B	UVR337M1CG1B	13	5200	12	1056
16	470	8 x 12	F12	UVR477M1CF12	14	4700	12	1504
16	470	10 x 12.5	G1B	UVR477M1CG1B	13	5200	12	1504
16	680	10 x 12.5	G1B	UVR687M1CG1B	18	4750	12	2176

Specifications are subject to change without notice. Should a safety or technical concern arise regarding the product, please be sure to contact our sales offices or agents immediately.

總公司 HEAD OFFICE

香港

HONG KONG

萬裕電子有限公司

香港柴灣嘉業街10號

益高工業大廈16字樓

Man Yue Electronics Co., Ltd.

16/F., Yiko Industrial Building,

10 Ka Yip Street, Chai Wan, Hong Kong

電話 TEL: (852) 2897 5277

傳真 FAX: (852) 2558 6299

分公司 BRANCH OFFICE

香港

HONG KONG

X-CON電子有限公司

香港柴灣嘉業街10號

益高工業大廈19字樓C室

X-CON Electronics Ltd.

Unit C, 19/F., Yiko Industrial Building,

10 Ka Yip Street, Chai Wan, Hong Kong

電話 TEL: (852) 2897 5277

傳真 FAX: (852) 2558 6299

台灣

TAIWAN

香港商萬裕國際電子有限公司台灣分公司

台灣新北市23553中和區

連城路258號13樓之1

郵政編碼: 23553

Man Yue Electronics Co., Ltd.

Taiwan Branch (H.K.)

13F-1, No. 258 Liancheng Road,

Zhonghe District, New Taipei City,

Taiwan 23553, R.O.C.

Postal Code: 23553

電話 TEL: 886 (02) 8227 2227

傳真 FAX: 886 (02) 8227 2226

中國深圳 SHENZHEN, CHINA

萬晉電子(深圳)有限公司

中國深圳市羅湖區

寶安南路2014號振業大廈B座913·915

郵政編碼: 518000

Man Jin Electronics (Shenzhen) Co., Ltd.

Rm 913 & 915, Block B, 9/F., Zhenye Tower,

2014 Baoan South Road,

Luohu, Shenzhen City,

Guangdong Province, PR China

Postal Code: 518000

電話 TEL: 86 (755) 2586 2216

傳真 FAX: 86 (755) 2586 2239

中國上海

SHANGHAI, CHINA

萬發國際貿易(上海)有限公司

中國江蘇省無錫市錫山經濟開發區

東亭鎮春暉東路148號

郵政編碼: 214101

Man Fat International Trading

(Shanghai) Co., Ltd.

148 Chunhui East Road, Dongting Town,

Xishan Economic Development Zone,

Wuxi, Jiangsu Province, PR China

Postal Code: 214101

電話 TEL: 86 (510) 8866 2688

傳真 FAX: 86 (510) 8865 2933

中國上海市寶山區

共和新路4995號611室

郵政編碼: 200435

Room 611,

No.4995 Gong He Xin Road,

Baoshan District,

Shanghai, PR China

Postal Code: 200435

電話 TEL: 86 (021) 6639 2180

傳真 FAX: 86 (021) 6639 2180

中國廠址 PRC MANUFACTURING PLANTS

中國東莞

DONGGUAN, CHINA

萬星光電子(東莞)有限公司

中國廣東省東莞市長安鎮烏沙村

興發南路新星工業園

郵政編碼: 523857

Starzeon Electronics (Dongguan) Co., Ltd.

Xin Xing Industrial Area,

Xing Fa South Road, Wu Sha Village,

Changan Town, Dongguan,

Guangdong Province, PR China

Postal Code: 523857

電話 TEL: 86 (769) 8115 2888

傳真 FAX: 86 (769) 8542 1790

萬裕三信電子(東莞)有限公司

中國廣東省東莞市長安鎮烏沙村

興發南路新星工業園

郵政編碼: 523857

Samxon Electronics (Dongguan) Co., Ltd.

Xin Xing Industrial Area,

Xing Fa South Road, Wu Sha Village,

Changan Town, Dongguan,

Guangdong Province, PR China

Postal Code: 523857

電話 TEL: 86 (769) 8228 6000 / 8532 3339

傳真 FAX: 86 (769) 8541 6401

www.manyue.com

X-ON Electronics

Largest Supplier of Electrical and Electronic Components

Click to view similar products for [Aluminum Electrolytic Capacitors - Leaded](#) category:

Click to view products by [Man Yue](#) manufacturer:

Other Similar products are found below :

[LXY50VB4.7M-5X11](#) [MAL203125221E3](#) [MAL204216159E3](#) [ESMG101ETD100MF11S](#) [RBC-25V-10UF-4X7](#) [RE3-35V222MJ6#](#) [RFO-100V471MJ7P#](#) [B41041A2687M8](#) [B41041A7226M8](#) [B41044A7157M6](#) [EKRG250ELL100MD07D](#) [EKXG201EC3101ML20S](#)
[EKXG351ETD6R8MJ16S](#) [EKZM160ETD471MHB5D](#) [EPA-201ELL151MM25S](#) [NCD681K10KVY5PF](#) [NRLF103M25V35X20F](#)
[KM4700/16](#) [KME50VB100M-8X11.5](#) [RXJ222M1EBK-1625](#) [SG220M1CSA-0407](#) [ES5107M016AE1DA](#) [ESX472M16B](#) [MAL211929479E3](#)
[40D506F050DF5A](#) [TE1202E](#) [36DA273F050BB2A](#) [KME25VB100M-6.3X11](#) [511D336M250EK5D](#) [511D337M035CG4D](#)
[515D477M035CG8PE3](#) [052687X](#) [EKMA500ELL4R7ME07D](#) [EKRG100ETC221MF09D](#) [NRE-S560M16V6.3X7TBSTF](#)
[ERZA630VHN182UP54N](#) [MAL214099813E3](#) [MAL211990518E3](#) [MAL204281229E3](#) [NEV680M35EF](#) [686KXM050M](#) [ERS1VM222L30OT](#)
[EGW2GM150W16OT](#) [EGS2GM6R8G12OC](#) [EHS2GM220W20OT](#) [ERF1VM222L30OT](#) [ERF1KM151G20OT](#) [EKZE500ELL101MHB5D](#)
[EKMM251VSN221MP25S](#) [RGA221M1HBK-1016G](#)