

Sensitivity Wavelength Range: 250-1100nm

The MT03-021 is a square (1.1 x1.1) 1.2mm² active area Silicon Photodiode in a surface mount package with clear encapsulation. It is optimized for applications requiring high sensitivity in the 300 to 500nm region (UVA, Blue & Green).

Features

- > Ultra Low Noise
- > High Shunt Resistance
- > Wide Dynamic Range
- > 365nm & Blue/Green Enhanced

Applications

- > Flame Detection
- > Currency Authentication
- > Spectroscopy Equipment
- > Fluorescence

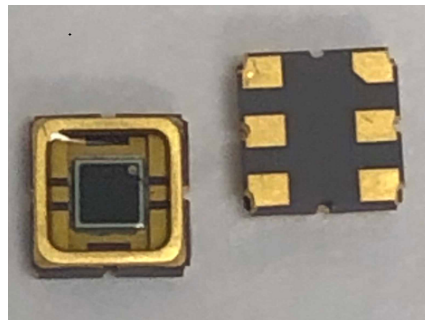

Absolute Maximum Ratings



Items	Symbol	Rating	Unit
Reverse Voltage	V _R	50	V
Operating Temperature Range	T _{opr}	-40 ~ +100	°C
Storage Temperature Range	T _{stg}	-55 ~ +125	°C
Lead Soldering Temperature*1	T _{ls}	260	°C

*1: Time 5 Sec max, Position: Up to 3mm from the body.

Electrical & Optical Characteristics (T_a = 23°C)

Items	Symbol	Conditions	MIN	TYP	MAX	Unit
Dark Current	I _d	V _R =5V	--	0.2	1.0	nA
Breakdown Voltage	V _(BR)	I _R =10μA	50	--	--	V
Spectral Sensitivity	λ	--	--	250-1100	--	nm
Peak Sensitivity	λ _p	--	--	950	--	nm
Wavelength Responsivity	R	V _R =0V, λ=365nm	--	0.22	--	A/W
Responsivity	R	V _R =0V, λ=633nm	--	0.40	--	A/W
Response Time @635nm	T _r	R _L =50Ω, V _R =5V	--	20	--	ns
Junction Capacitance	C _j	@ 1MHz, V _R =0V	--	20	--	pF
Junction Capacitance	C _j	@ 1MHz, V _R =5V	--	6	8	pF
Shunt Resistance	R _{sh}	V _R =10mV	500	800	--	MΩ

SMD Package Dimensions (6 Pads)

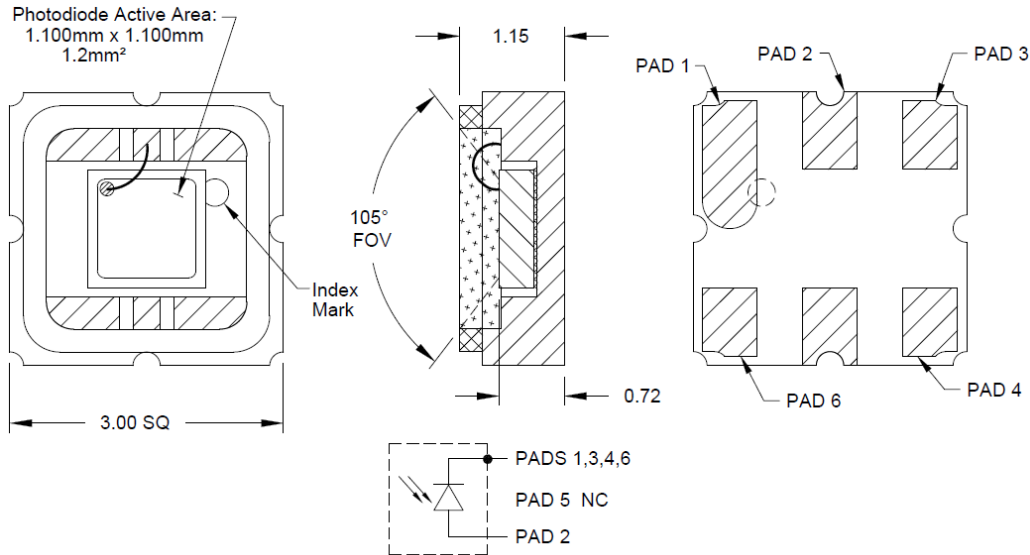

Capacitance vs Reverse Bias

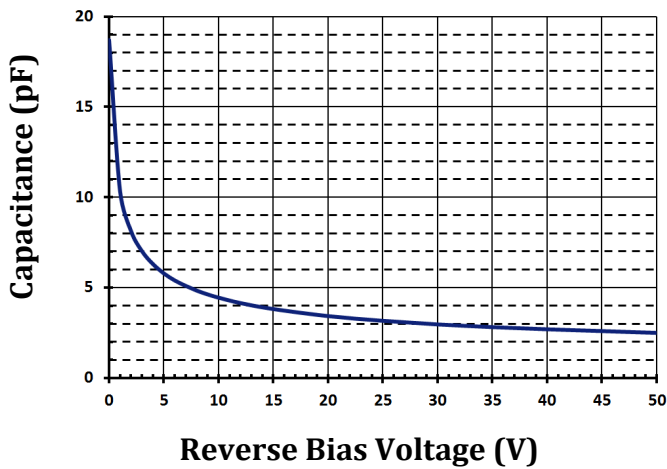

Dark Current vs Reverse Bias (23°C)

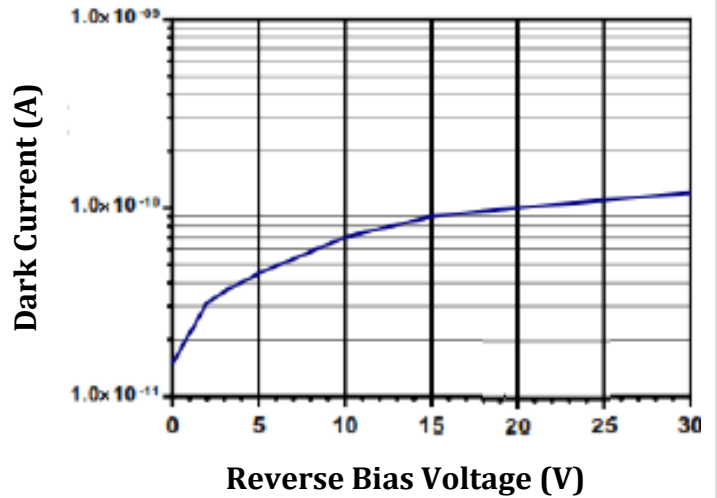

Dark Current vs Temperature ($V_r=10V$)

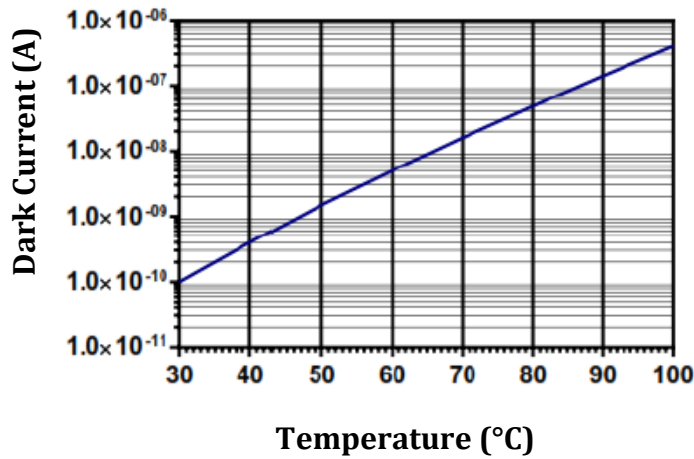

Series 4 Quantum Efficiency (23°C)

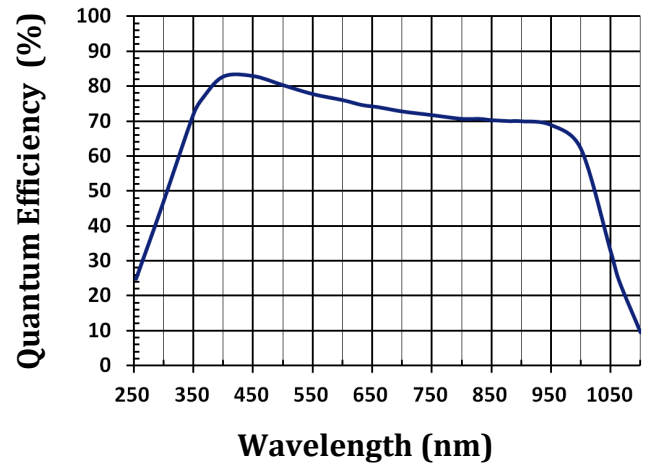

Photodiode Responsivity by Series

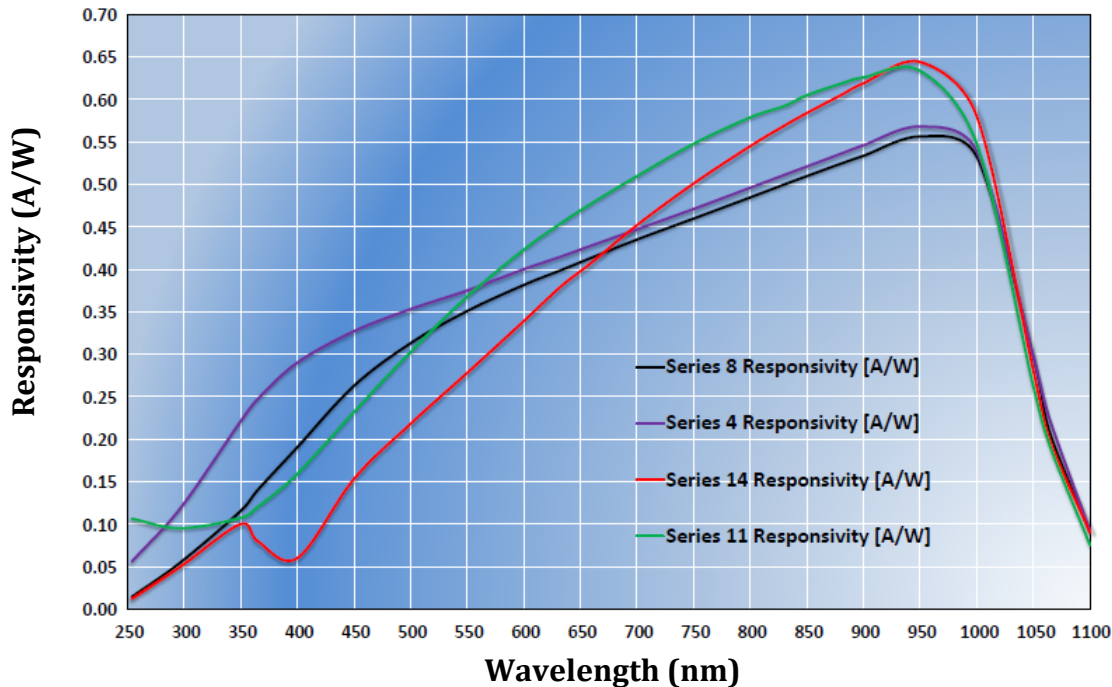

The information contained herein is subject to change without notice.

2019-03

X-ON Electronics

Largest Supplier of Electrical and Electronic Components

Click to view similar products for [Photodiodes](#) category:

Click to view products by [Marktech](#) manufacturer:

Other Similar products are found below :

[LTR-526AD](#) [OED-SP-7L](#) [LTR-536AB](#) [LTR-743DBM1-TA](#) [67-21SYGC-S349-TR8](#) [SFH 2200 A01](#) [HFD3081-108-XBA](#) [BPW 34 S E9601](#)
[SFH 2713](#) [SFH 2703](#) [LTR-546AD](#) [BPV23FL](#) [BPW 34 FAS](#) [BPW 34 FS](#) [IG17X1000S4I](#) [IG22X250S4I](#) [VTD205H](#) [VTD205KH](#)
[VTP1232FH](#) [VTP4085H](#) [SFH 2400](#) [OP913WSL](#) [OPF794](#) [PD70-01C/TR7](#) [LTR-536AD](#) [VTP8651H](#) [VTD206KH](#) [VTB1013H](#) [BPV23NF](#)
[OP905](#) [LTR-516AD](#) [BPW 34 FS-Z](#) [VTD34FH](#) [QSB34CGR](#) [SFH 2500 FA](#) [PD15-22C/TR8](#) [VEMD5510C](#) [SFH 2200](#) [VEMD5510CF](#)
[SAH230M](#) [SAH230M2](#) [SAH500M2](#) [MTAPD-07-010](#) [BP 104 FS](#) [BPV22F-AS12](#) [BPW 21](#) [BPW 34 SR-Z](#) [BPX 65](#) [HSDL-5400#011](#) [BPW](#)
[34 FASR](#)