

Peak Sensitivity Wavelength: 905nm

The MTAPD-07-xxx is a circular ($\Phi 500\mu\text{m}$) .2 mm² active area Avalanche Photodiode with optimized sensitivity at 905nm & housed in a LCC6 SMD package. It is well suited for applications requiring High Speed & Low Noise in visible-near IR applications.

FEATURES

- >Fast Rise Time
- >Ultra Low Noise
- >Low Capacitance
- >High Gain
- >Optimum Gain M100

- >Operating Voltages:
120v - 160v
160v - 200v
Other Voltages Available

APPLICATIONS

- >Optical rangefinders
- >High speed optical communications
- >Medical Equipment
- >Bar Code Readers

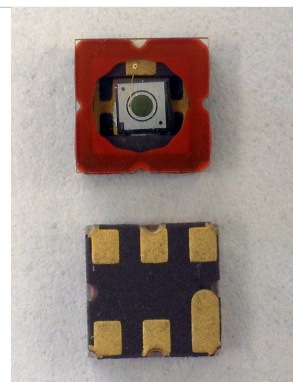

Absolute Maximum Ratings



ITEMS	SYMBOL	RATINGS	UNIT
Storage Temperature	Tstg	-55 ~ +125	°C
Operating Temperature	Topr	-20 ~ +85	°C
Power Dissipation	Pd	1	mw
Forward Current	If	1	mA
Operating Voltage	Vop	0.95 x Vbr	V
Solder Reflow Temperature *1	Stemp	260	°C

*1: Time 5 Sec max

Electrical & Optical Characteristics (Ta=23°C)

ITEMS	SYMBOL	CONDITIONS	MIN.	TYP	MAX.	UNIT
Spectral Response	λ	--		400 - 1100		nm
Active Area		--		Diameter 500		um
Responsivity	Re	$\lambda=905\text{nm}$, $\varphi_e=1\mu\text{W}$, M=100	50	55	--	A/W
Rise Time	tR	f=1MHz, RL=50Ω, $\lambda=905\text{nm}$	--	0.6	--	ns
Dark Current	I _D	M=100	0.1	0.4	1.0	nA
Capacitance	Cj	M=100, f=1MHz		1.2		pF
Optimal Gain	M	--		100		
Breakdown Voltage	Vbr	IR=2uA	80	--	200	V
Temperature Coefficient		Tc=-40°C - 85°C		0.9		V/°C

LCC6 SMD Package Dimensions (6 Pin)

MTAPD-07-015 Vbr=120-160V
MTAPD-07-016 Vbr=160-200V

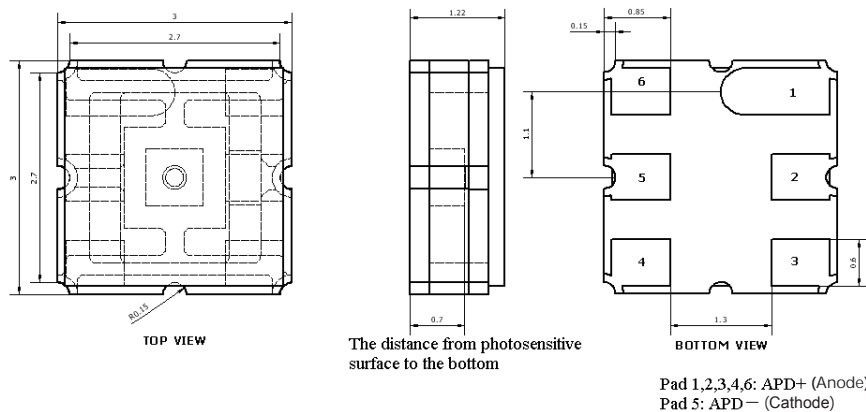

Unit: mm, Tolerance: ± 0.2

Fig 1 Responsivity, Vr=0V

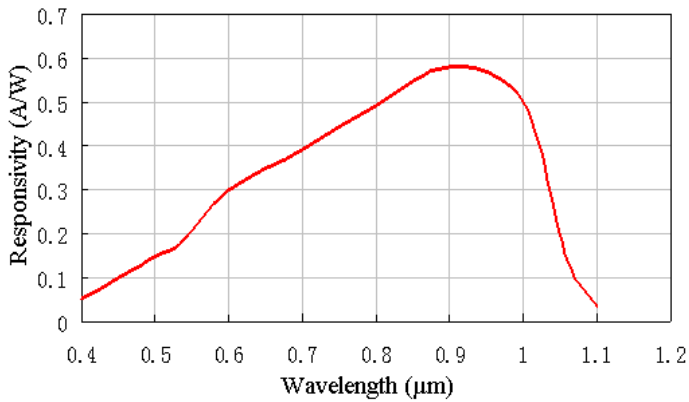

Fig 2 Dark Current

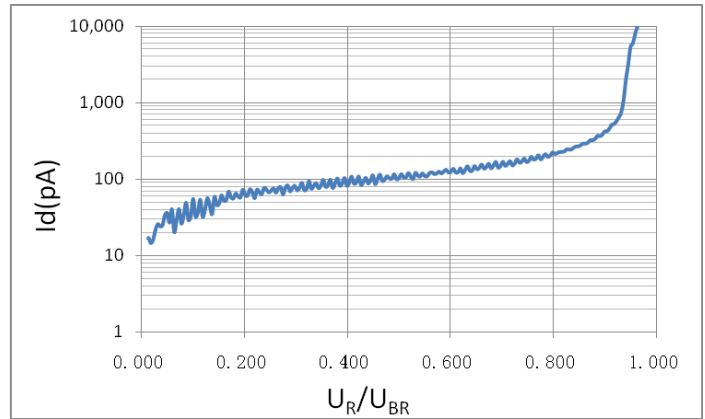

Fig 3 Multiplication

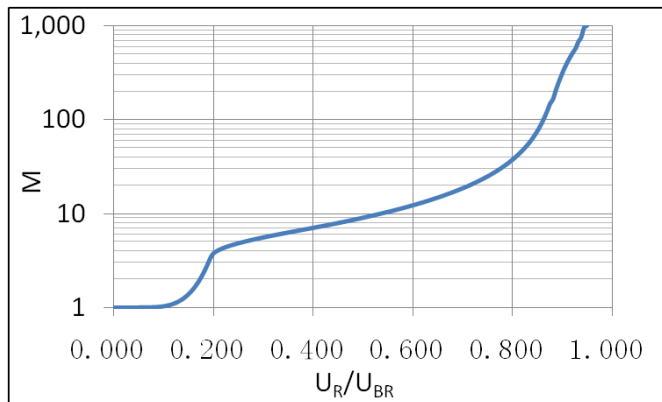
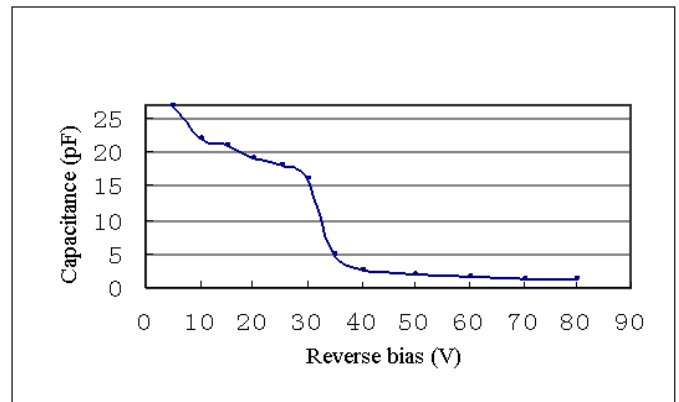
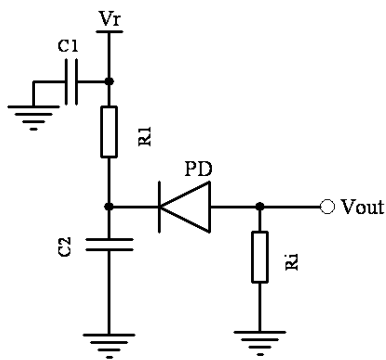

Fig 4 Capacitance



Applications Diagram



- Notes: C1 - Filter capacitor, filter noise from Vr.
 C2 - bypass capacitor, the loop to ground for AC signal.
 R1 - current-limiting resistor, protect APD from higher voltage.
 Ri - sampling resistor, convert the current signal into a voltage signal.

Equivalent Circuit Diagram

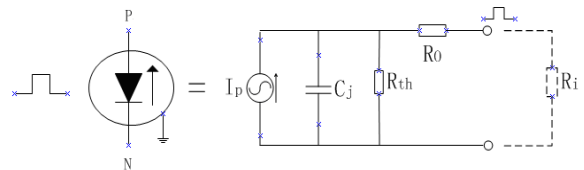

X-ON Electronics

Largest Supplier of Electrical and Electronic Components

Click to view similar products for [Photodiodes](#) category:

Click to view products by [Marktech](#) manufacturer:

Other Similar products are found below :

[LTR-526AD](#) [OED-SP-7L](#) [LTR-536AB](#) [LTR-743DBM1-TA](#) [67-21SYGC-S349-TR8](#) [SFH 2200 A01](#) [HFD3081-108-XBA](#) [BPW 34 S E9601](#)
[SFH 2713](#) [SFH 2703](#) [LTR-546AD](#) [BPV23FL](#) [BPW 34 FAS](#) [BPW 34 FS](#) [VTD205H](#) [VTD205KH](#) [VTP1220FBH](#) [VTP1232FH](#) [VTP4085H](#)
[OP913WSL](#) [LTR-536AD](#) [VTP8651H](#) [VTD206KH](#) [VTB1013H](#) [BPV23NF](#) [OP905](#) [LTR-516AD](#) [BPW 34 FS-Z](#) [VTD34FH](#) [QSB34CGR](#)
[PD15-22C/TR8](#) [VEMD5510C](#) [SFH 2200](#) [VEMD5510CF](#) [APS5130PD7C-P22](#) [SAH230M](#) [SAH230M2](#) [SAH500M2](#) [BP 104 FS](#) [BPW 21](#)
[BPW 34 SR-Z](#) [BPX 65](#) [HSDL-5400#011](#) [SFH 2430](#) [OP993](#) [OPF420](#) [OPF430](#) [OPF472](#) [OPR2101](#) [PC10-6B-TO5](#)