

Peak Sensitivity Wavelength: 880nm

The MTD6100PT is a photo diode in a hermetically sealed pigtail package. It is well suited for high reliability and high sensitivity applications.

FEATURES

- > Linearity of Ee vs IL
- > Low Dark Current / Metal Can Package
- > Narrow Angular Response
- > High Reliability in Demanding Environments

APPLICATIONS

- > Optical Switches
- > Edge Sensing
- > Fiber Optical Communications
- > Smoke Detectors



Absolute Maximum Ratings (Ta=25°C)



ITEMS	SYMBOL	RATINGS	UNIT
Reverse Voltage	VR	30	V
Power Dissipation	PD	100	mW
Operating Temperature Range	Topt	-30 ~ +100	°C
Storage Temperature Range	Tstg	-40 ~ +125	°C
Junction Temperature	Tj	125	°C
Lead Soldering Temperature*1	Tls	260	°C

*1: Time 5 Sec max, Position: Up to 3mm from the body.

Electrical & Optical Characteristics (Ta = 25°C)

ITEMS	SYMBOL	CONDITIONS	MIN	TYP	MAX	UNIT
Open Circuit Voltage	Voc	Ee=5mW/cm ² *1	0.35	--	--	V
Light Current	IL	*1, *2	--	10	--	μA
Dark Current	ID	VR=10V	--	--	10	nA
Curve Factor	CF	Ee=5mW/cm ² *1	0.55	--	--	--
Spectral Sensitivity	λ	--	--	400~1100	--	nm
Peak Sensitivity Wavelength	λp	--	--	880	--	nm
Switching Time (Rise Time)	Tr	R=1000Ω, Vr=10V	--	6	--	nS
Switching Time (Fall Time)	Tf	R=1000Ω, Vr=10V	--	6	--	nS
Angular Response	θ	--	--	±10	--	deg
Junction Capacitance	Cj	at 1MHz, V=5V	--	5	10	pF

*1: Color Temperature=2870°K Standard Tungsten Lamp, *2: VR=10V, Ee=5mW/cm².

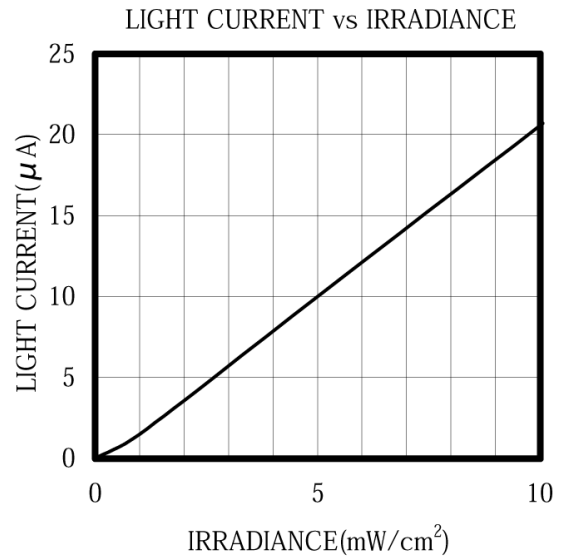
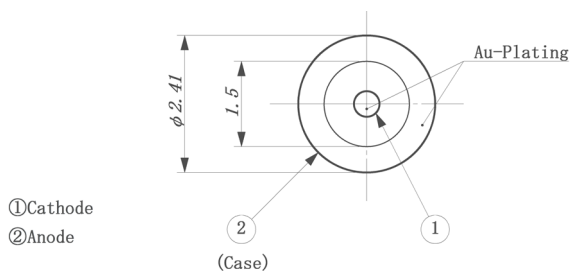
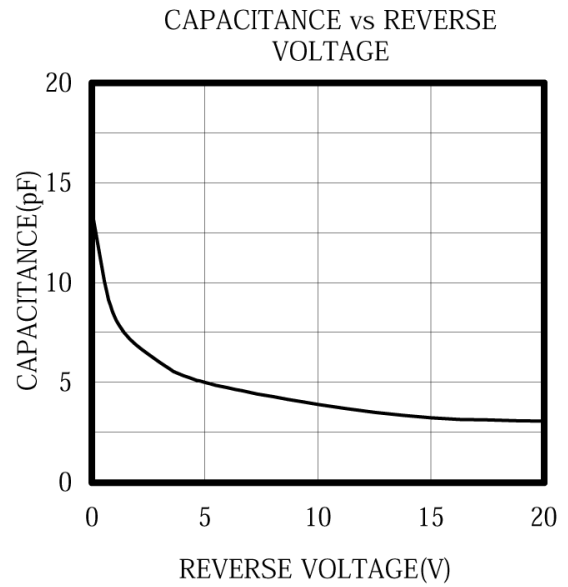
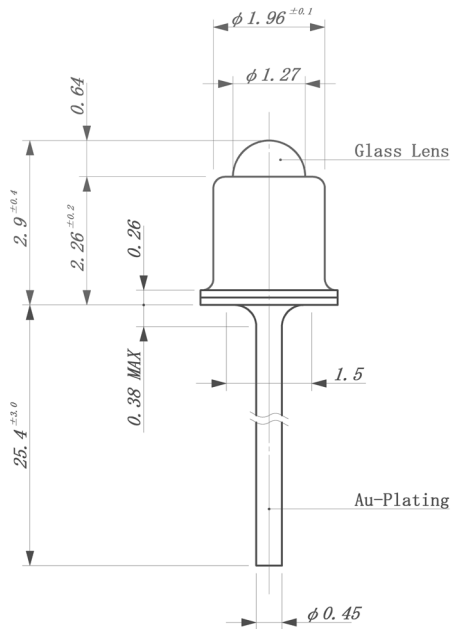

Unit: mm, Tolerance: ± 0.2

ANGULAR DISPLACEMENT

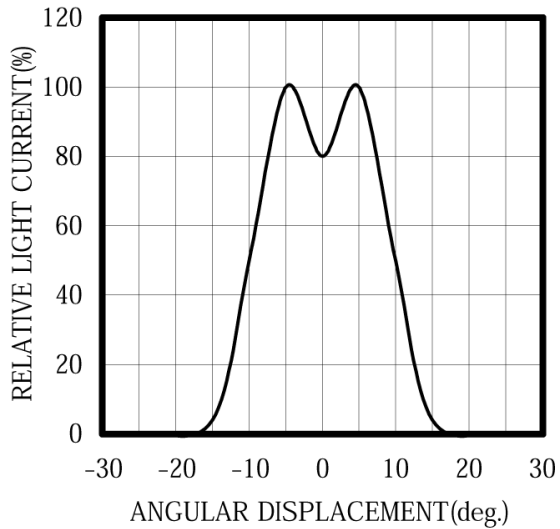

THERMAL DERATING CURVE

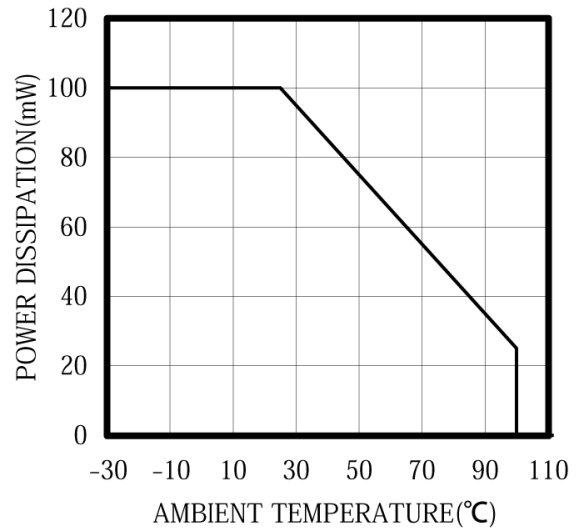

RESPONSIVITY

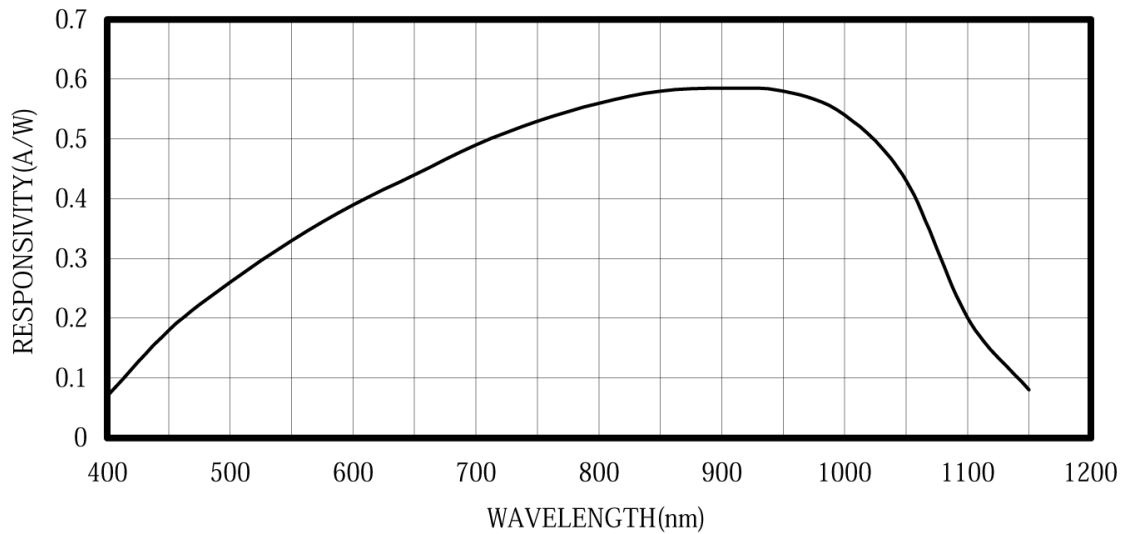

X-ON Electronics

Largest Supplier of Electrical and Electronic Components

Click to view similar products for [Photodiodes](#) category:

Click to view products by [Marktech](#) manufacturer:

Other Similar products are found below :

[LTR-526AD](#) [OED-SP-7L](#) [LTR-536AB](#) [LTR-743DBM1-TA](#) [67-21SYGC-S349-TR8](#) [SFH 2200 A01](#) [HFD3081-108-XBA](#) [BPW 34 S E9601](#)
[SFH 2713](#) [SFH 2703](#) [LTR-546AD](#) [BPV23FL](#) [BPW 34 FAS](#) [BPW 34 FS](#) [VTD205H](#) [VTD205KH](#) [VTP1220FBH](#) [VTP1232FH](#) [VTP4085H](#)
[OP913WSL](#) [LTR-536AD](#) [VTP8651H](#) [VTD206KH](#) [VTB1013H](#) [BPV23NF](#) [OP905](#) [LTR-516AD](#) [BPW 34 FS-Z](#) [VTD34FH](#) [QSB34CGR](#)
[PD15-22C/TR8](#) [VEMD5510C](#) [SFH 2200](#) [VEMD5510CF](#) [APS5130PD7C-P22](#) [SAH230M](#) [SAH230M2](#) [SAH500M2](#) [BP 104 FS](#) [BPW 21](#)
[BPW 34 SR-Z](#) [BPX 65](#) [HSDL-5400#011](#) [SFH 2430](#) [OP993](#) [OPF420](#) [OPF430](#) [OPF472](#) [OPR2101](#) [PC10-6B-TO5](#)