

## Peak Emission Wavelength: 660nm

The MTE5066C-UR is a red T 1, 3mm water clear emitter designed for applications requiring high power output and high reliability in a narrow angle package. It can be custom sorted for specific power output ranges.

### FEATURES

- > High Reliability
- > High Power Output
- > Compact

### APPLICATIONS

- > Optical Sensing
- > Optical Instruments
- > Linear & Rotary Encoder
- > Machine Vision / CCD

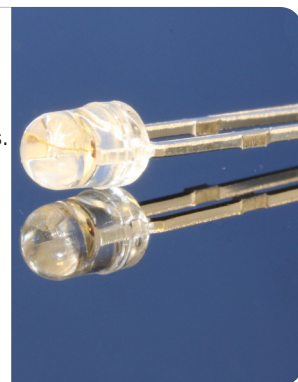

## Absolute Maximum Ratings (Ta=25°C)



ITEMS	SYMBOL	RATINGS	UNIT
Forward Current (DC)	IF	50	mA
Forward Current (Pulse)*1	IFP	0.5	A
Reverse Voltage	VR	5	V
Power Dissipation	PD	110	mW
Operating Temperature Range	Topr	-20 ~ +80	°C
Storage Temperature Range	Tstg	-30 ~ +100	°C
Junction Temperature	Tj	100	°C
Lead Soldering Temperature*2	Tls	260	°C

\*1: Tw=10μsec, T=10msec; \*2: Time 5 Sec max, Position: Up to 3mm from the body.

## Electrical & Optical Characteristics (Ta = 25°C)

ITEMS	SYMBOL	CONDITIONS	MIN	TYP	MAX	UNIT
Power Output	PO	IF=20mA	4.0	7.0	--	mW
Forward Voltage	VF	IF=20mA	--	1.8	2.2	V
Reverse Current	IR	VR=5V	--	--	100	μA
Peak Emission Wavelength	λp	IF=20mA	--	660	--	nm
Spectral Line Half Width	Δλ	IF=20mA	--	25	--	nm
Half Intensity Beam Angle	Θ	IF=20mA	--	±18	--	deg
Rise Time	Tr	IFP=20mA	--	30	--	nS
Fall Time	Tf	IFP=20mA	--	30	--	nS
Junction Capacitance	Cj	1MHz, V=0V	--	20	--	pF
Temperature Coefficient of PO	P/T	IF=10mA	--	-0.5	--	%/°C
Temperature Coefficient of VF	V/T	IF=10mA	--	-1.5	--	mV/°C

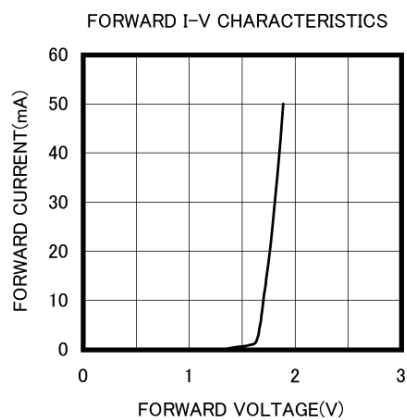
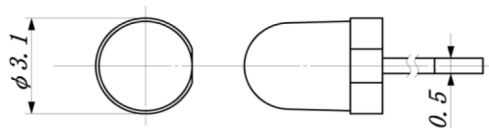
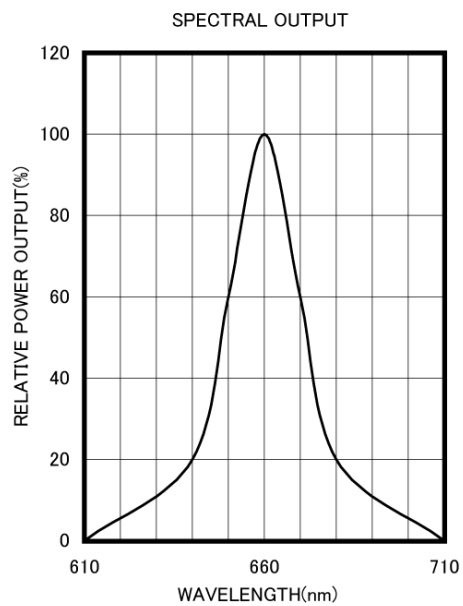
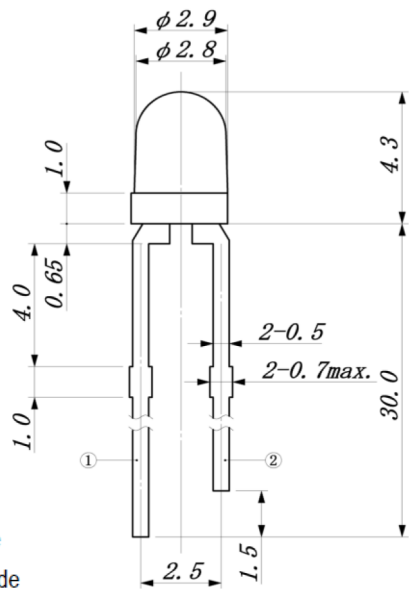

Unit: mm, Tolerance:  $\pm 0.2$

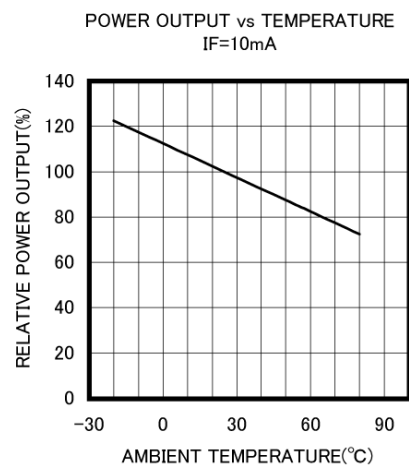
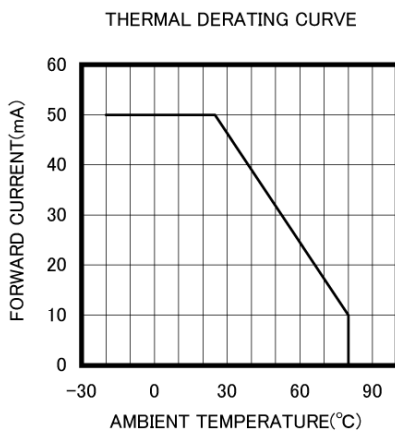
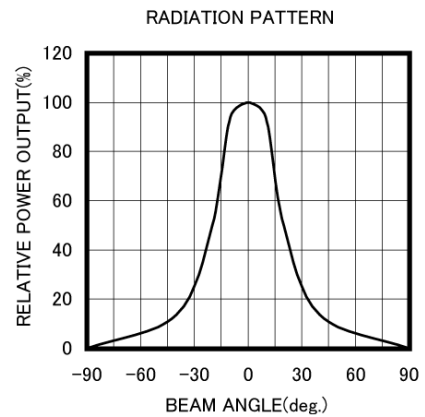
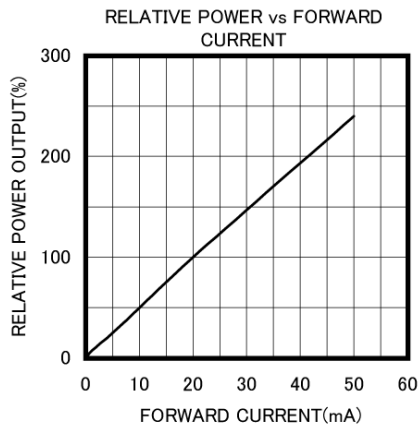

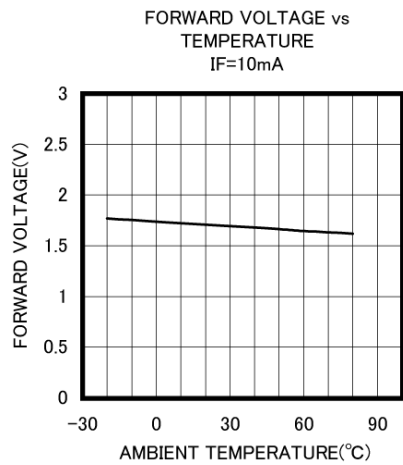

## X-ON Electronics

Largest Supplier of Electrical and Electronic Components

*Click to view similar products for [Standard LEDs - Through Hole category:](#)*

*Click to view products by [Marktech manufacturer:](#)*

Other Similar products are found below :

[LTL-10254W](#) [LTL-1214A](#) [LTL-2231AT](#) [LTL-3251A](#) [LTL-4262N](#) [LTL-433P](#) [LTL-5234](#) [LTL87HTBK](#) [LTX-87HD4B](#) [HLMP-EL30-PS0DD](#) [1L0532V23G0TD001](#) [NSPW500CS](#) [LD CQDP-1U3U-W5-1-K](#) [LP379PPG1C0G0300001](#) [SLR-342MC3F](#) [SLX-LX3044GD](#) [SLX-LX3044ID](#) [SLX-LX3044YD](#) [1.90690.3330000](#) [SSS-LX4673ID-410B](#) [1L0532Y24I0TD001](#) [264-7SYGD/S530-E2](#) [HLMP-1301-G00FG](#) [HLMP1385](#) [LTL-10224W](#) [LTL-1224A](#) [LTL-1234A](#) [LTL-2251AT](#) [LTL-403HR](#) [LTL-4222](#) [LU7-E-B](#) [4380H1](#) [HLMP-3962-F0002](#) [HLMP-GG15-R0000](#) [323-2SURD/S530-A3](#) [L53SRC/E-Z](#) [L-7679C1ZGC](#) [4302T1-5V](#) [4306D23](#) [4363D1/5](#) [WP1503SRC/J4](#) [WP153YDT](#) [WP1543SGC](#) [WP1543SURC](#) [WP53MGD](#) [WP7113HD](#) [WP7113MBD](#) [WP7113MGC](#) [WP7143SEC/H](#) [Z-221A](#)