

Peak Emission Wavelength: 1070nm

The MTE7110N5 consists of a 1070nm high output infrared die in a water-clear 5mm plastic molded dome shaped package. Custom package solutions and sorting are available.

FEATURES

- > High Output Power
- > Narrow Beam Angle
- > High Reliability

APPLICATIONS

- > Optical Switches & Sensors
- > Fiber Optical Communication
- > Bar-code Reader

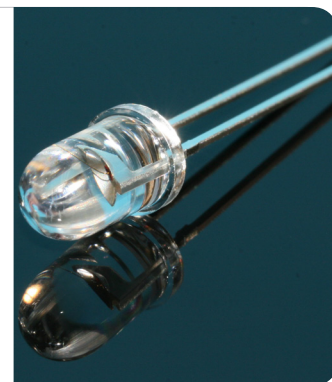

Absolute Maximum Ratings (Ta=25°C)



ITEMS	SYMBOL	RATINGS	UNIT
Forward Current (DC)	IF	100	mA
Forward Current (Pulse)*1	IFP	1	A
Reverse Voltage	VR	5	V
Power Dissipation	PD	140	mW
Operating Temperature Range	Topr	-20 ~ +80	°C
Storage Temperature Range	Tstg	-30 ~ +100	°C
Junction Temperature	Tj	100	°C
Lead Soldering Temperature*2	Tls	260	°C

*1: Tw=10μsec, T=10msec. *2: Time 5Sec max, Position: Up to 3mm from the body.

Electrical & Optical Characteristics (Ta = 25°C)

ITEMS	SYMBOL	CONDITIONS	MIN	TYP	MAX	UNIT
Power Output	PO	IF=20mA	--	12	--	mW
Power Output	PO	IF=50mA	--	30	--	mW
Forward Voltage	VF	IF=20mA	--	1.25	--	V
Forward Voltage	VF	IF=50mA	--	1.30	--	V
Reverse Current	IR	VR=5V	--	--	100	μA
Peak Emission Wavelength	λp	IF=50mA	--	1070	--	nm
Spectral Line Half Width	Δλ	IF=50mA	--	45	--	nm
Half Intensity Beam Angle	Θ	IF=50mA	--	±5	--	deg

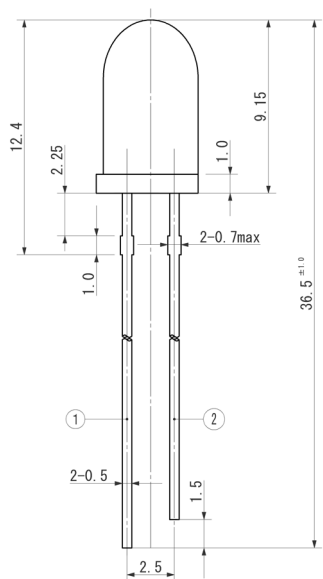

SPECTRAL OUTPUT

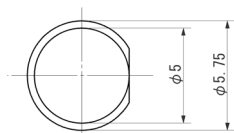
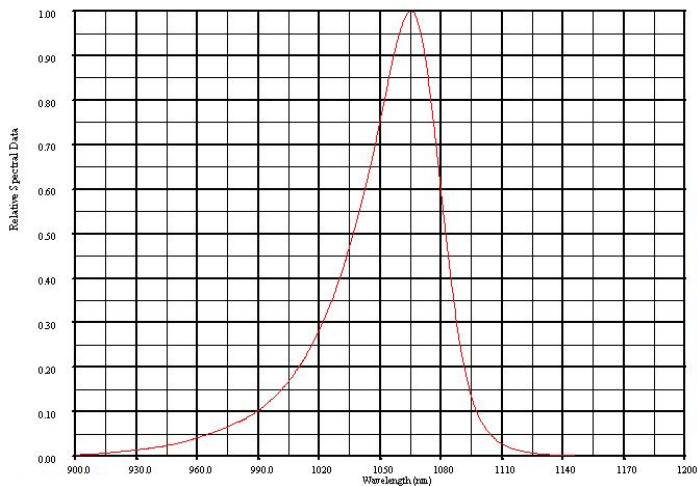

Forward I-V Characteristics

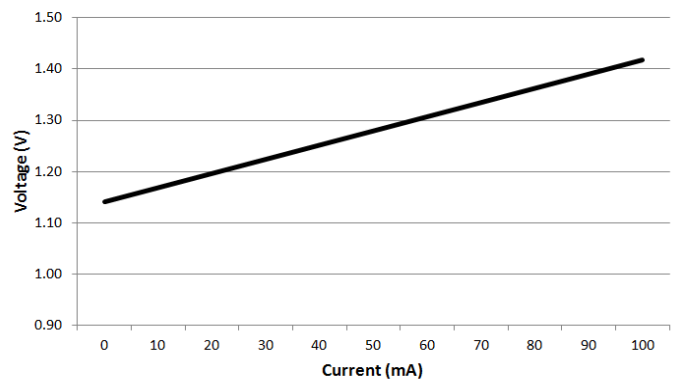

Unit: mm, Tolerance: ± 0.2

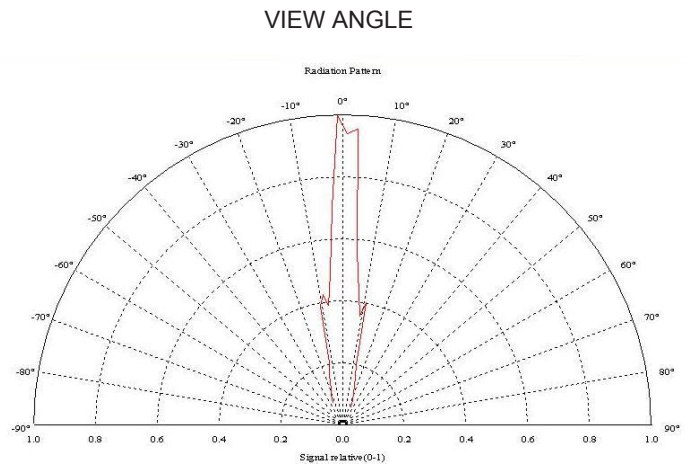
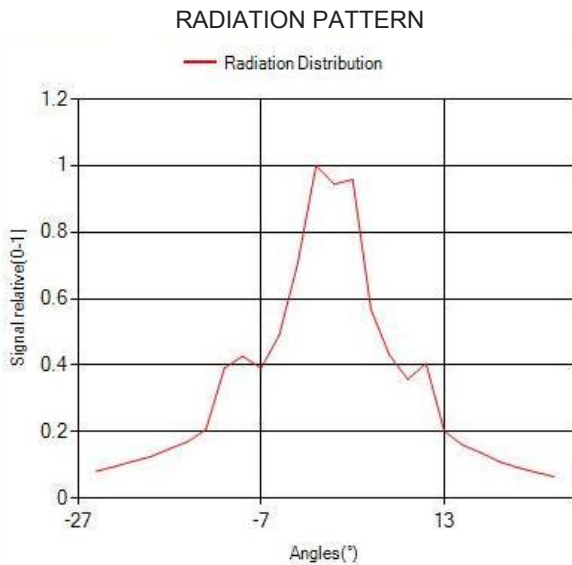
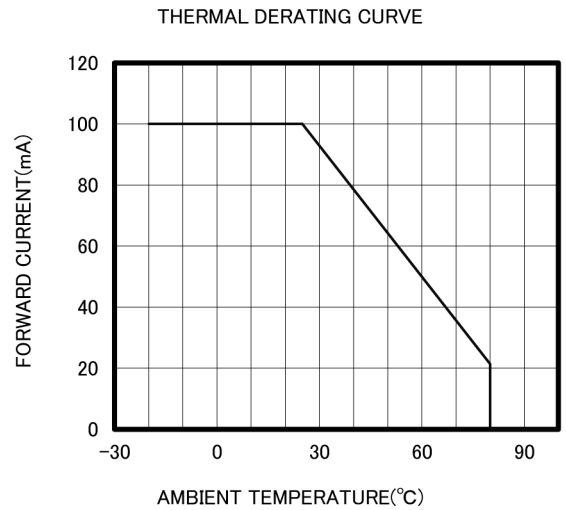

The information contained herein is subject to change without notice.

2019-06-18

X-ON Electronics

Largest Supplier of Electrical and Electronic Components

Click to view similar products for [Infrared Emitters](#) category:

Click to view products by [Marktech](#) manufacturer:

Other Similar products are found below :

[LTE-3279K](#) [LTE-4206C](#) [LTE-4208C](#) [IR333C](#) [LTE-2871C](#) [LTE-4238](#) [ASDL-4264-C22](#) [OED-EL305F4C50-HT](#) [LTE-3376](#) [IN-S126ETIR](#)
[IN-S126DSHIR](#) [IN-S126ETHIR](#) [IN-P32ZTHIR](#) [IN-S42CTQHIR](#) [IN-S126BTHIR](#) [IN-S63DTHIR](#) [IN-S85BTHIR](#) [IN-S63FTHIR](#)
[EAIST3535A4](#) [VSMA1085250](#) [VSMA1085400](#) [VSMA1085600](#) [VSMA1094250](#) [VSMA1094400](#) [VSMA1094600](#) [XL-1608HIRC-850](#) [XL-](#)
[2012HIRC-850](#) [LTE-C216-P-W](#) [ZIR-1608C-06A-Z4](#) [ZIR-3528C-18-Z2](#) [ZIR-3216C-19-R15](#) [XL-2012IRC-940](#) [XL-3216IRC-940](#) [XL-](#)
[3216HIRC-850](#) [LTE-C9901](#) [MHT130ZVRCT](#) [DY-IRS302320C/3T](#) [APDA3020F3C-P22](#) [APHD1608F3C-P22](#) [APD2520F3C03-P22](#)
[APHD1608SF4CPRV-P22](#) [APD2520SF4C03-P22](#) [AN1102W-TR](#) [MTE8560MT-BK](#) [MTPS8085WS-WRC](#) [MTSM5010-199-IR](#) [MTE5010-](#)
[995-IR](#) [MTE7110N5](#) [MTE7110D4](#) [MTE5115C2](#)