

Peak Emission Wavelength: 950nm

The MTE9460N2 consists of a 950nm high output infrared die in a water-clear 5mm flat top plastic molded package. Custom package solutions and sorting are available..

FEATURES

- > High Output Power
- > High Reliability
- > Compact
- > Wide Beam Angle

APPLICATIONS

- > Optical Switches
- > Optical Sensors
- > Fiber Optical Communication

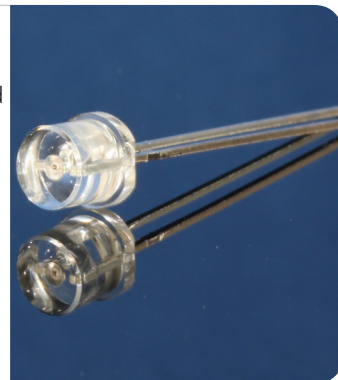

Absolute Maximum Ratings (Ta=25°C)



ITEMS	SYMBOL	RATINGS	UNIT
Forward Current	IF	100	mA
Forward Current (Pulse)*1	IFP	1	A
Reverse Voltage	VR	5	V
Power Dissipation	PD	190	mW
Operating Temperature Range	Topr	-20 ~ +85	°C
Storage Temperature Range	Tstg	-30 ~ +100	°C
Junction Temperature	Tj	100	°C
Lead Soldering Temperature*2	Tls	260	°C

*1: Tw=10μsec, T=10msec; *2: Time 5 Sec max, Position: Up to 3mm from the body.

Electrical & Optical Characteristics (Ta = 25°C)

ITEMS	SYMBOL	CONDITIONS	MIN	TYP	MAX	UNIT
Power Output	PO	IF=50mA	--	24	--	mW
Forward Voltage	VF	IF=50mA	--	1.30	1.90	V
Reverse Current	IR	VR=5V	--	--	10	μA
Peak Emission Wavelength	λp	IF=50mA	--	950	--	nm
Spectral Line Half Width	Δλ	IF=50mA	--	40	--	nm
Half Intensity Beam Angle	Θ	IF=50mA	--	±50	--	deg

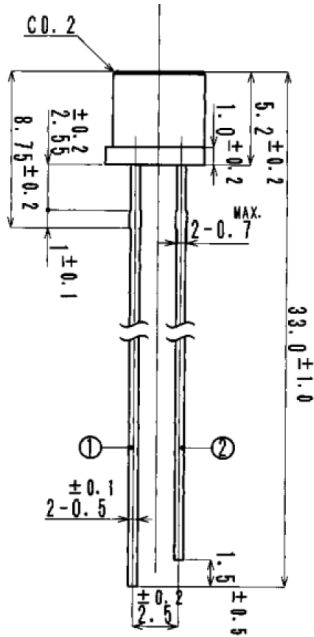

- ① Anode
- ② Cathode

SPECTRAL OUTPUT

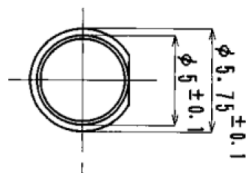
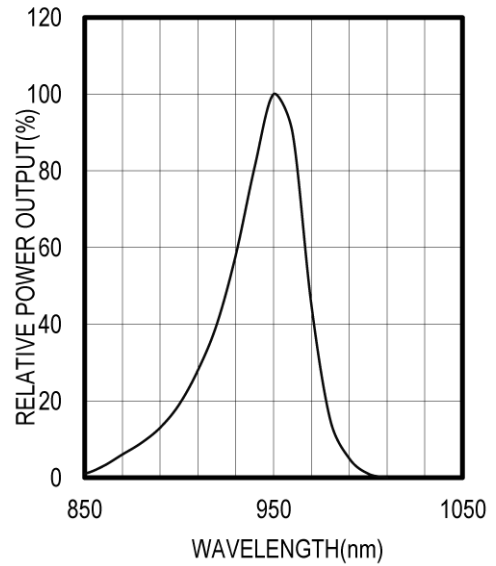

FORWARD I-V CHARACTERISTICS

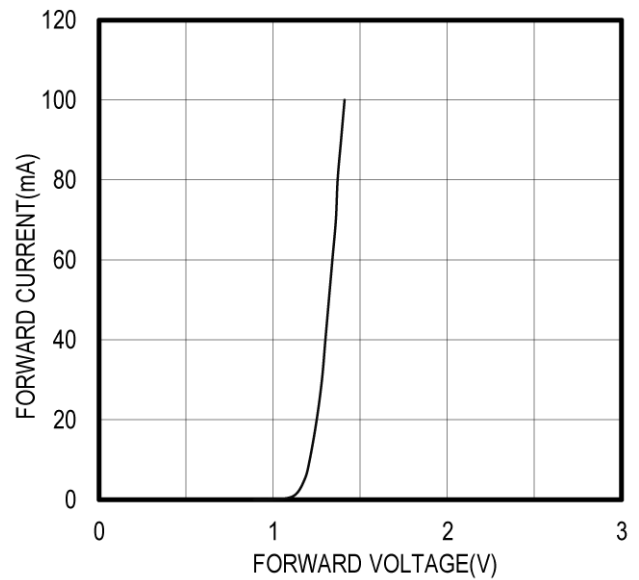

Unit: mm, Tolerance: ± 0.2

RELATIVE POWER vs FORWARD CURRENT

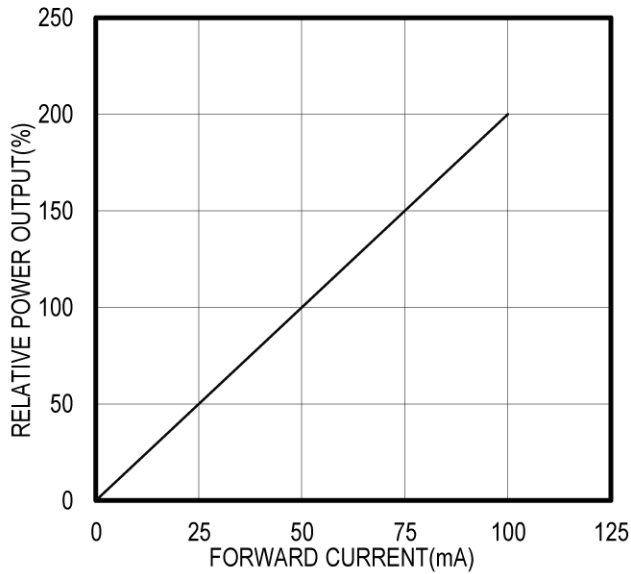

THERMAL DERATING CURVE

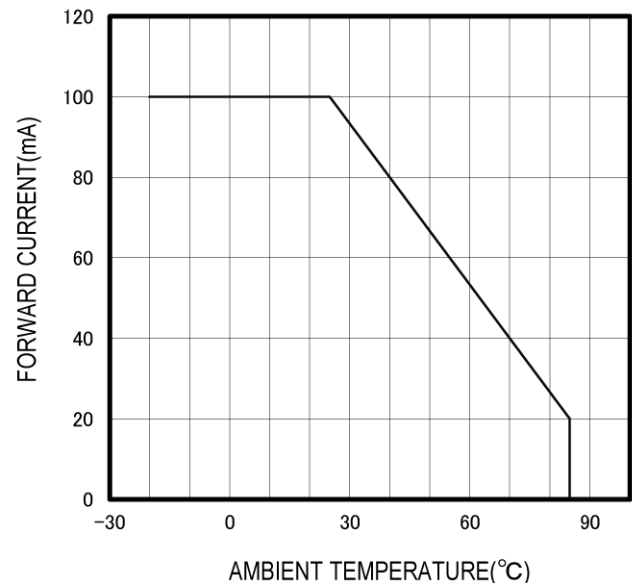

RADIATION PATTERN

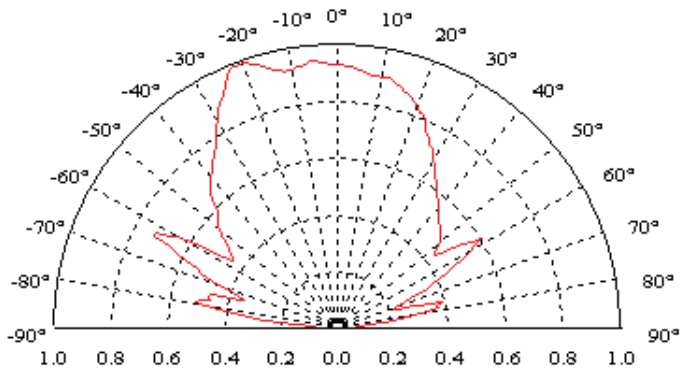

The information contained herein is subject to change without notice.

2013-05-07

X-ON Electronics

Largest Supplier of Electrical and Electronic Components

Click to view similar products for [Infrared Emitters - High Power](#) category:

Click to view products by [Marktech](#) manufacturer:

Other Similar products are found below :

[QED123UL](#) [TSHA6201](#) [TSHA6202](#) [SFH 4030](#) [SFH 4060](#) [SFH 4775S A01](#) [SFH 4726AS](#) [SFH 4717AS](#) [SFH 4725AS](#) [VSMY2890GX01](#)
[VSMY2890RGX01](#) [QEE123](#) [TSHA6200](#) [TSML1030](#) [VTE1291W-2H](#) [LL-304IRC4B-2AD](#) [LL-503HIRT2E-1CC](#) [LL-503IRC2E-2AC](#) [LL-503IRC2V-2AD](#) [LL-503IRT2E-2AC](#) [LL-503IRT2E-2AE](#) [LL-S170IRC-2A](#) [SFH 4259](#) [VSMB1940ITX01](#) [TSHA5500](#) [VTE1295H](#)
[TSAL6200-ES21](#) [KP-2012F3C](#) [SFH 4256](#) [SFH 4256-R](#) [SFH 4356-UV](#) [TSAL6100-AS12Z](#) [TSAL6100-MS12](#) [SFH 4651-UV](#) [SFH 4253 R-R](#)
[SFH 4059S-RS](#) [SFH 4715S-CBDA](#) [SFH 4716AS-BBCA](#) [SFH 4715A-CBDA](#) [SFH 4640-UV](#) [SFH 4243-Q1R2](#) [SFH 4059SR-RS](#) [TSHA6203-CS21](#) [LL-S150IRC-2A](#) [SFH 4253](#) [VTE3324LAH](#) [SFH 4247](#) [SFH 4250-R2/S](#) [LL-304HIRC4B-1CD](#) [LL-304HIRT4B-1CD](#)