

Sensitivity Wavelength Range: 600nm ~ 1750nm

The 1346 series from Marktech, a high sensitivity and high reliability product series, is ideally suited for Optical Communication devices. Custom packaging options for this die are also available.

FEATURES

- > High Speed Response (Max: 1Gbps)
- > TO-46 Metal Can Package
- > Active Area of 0.3mm / High Sensitivity
- > Spectral Range 600nm -- 1750nm

APPLICATIONS

- > High Speed Optical Communications
- > Optical LAN
- > Optical Switches
- > Ethernet Fiber Channel

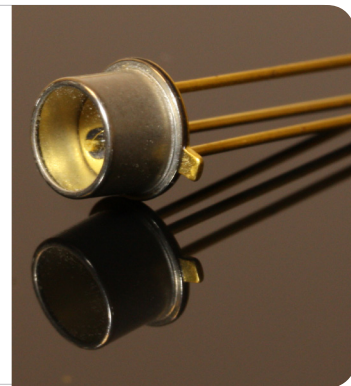

Absolute Maximum Ratings (Ta=25°C)

ITEMS	SYMBOL	RATINGS	UNIT
Active Area	Φ	0.3	mm
Operating Temperature Range	Topr	-40 ~ +85	°C
Storage Temperature Range	Tstg	-40 ~ +125	°C

Electrical & Optical Characteristics (Ta = 25°C)

ITEMS	SYMBOL	CONDITIONS	MIN	TYP	MAX	UNIT
Breakdown Voltage	VR	IR=10μA	5	--	--	V
Sensitivity Range	λ	VR=0V	600	--	1750	nm
Dark Current	ID	VR=2V	--	--	1.0	μA
Junction Capacitance	Cj	VR=0V	--	15	--	pF
Photo Current at 1300nm *1	IL	*2	--	30	--	μA

*1: As mounted on TO-46 gold header without resin coating. *2, VR=5V, Ee=1mW/cm²

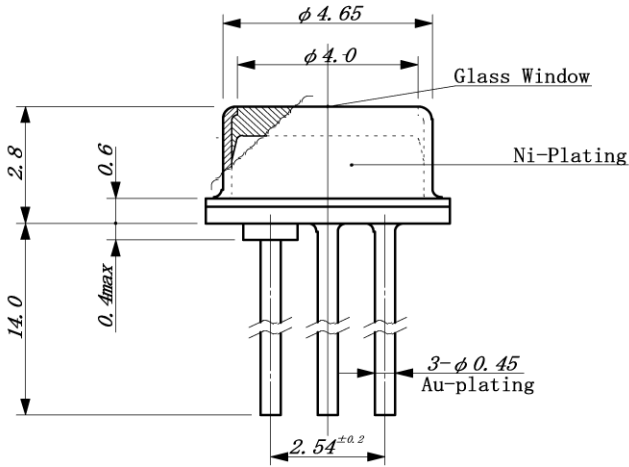

Unit: mm, Tolerance: ± 0.2

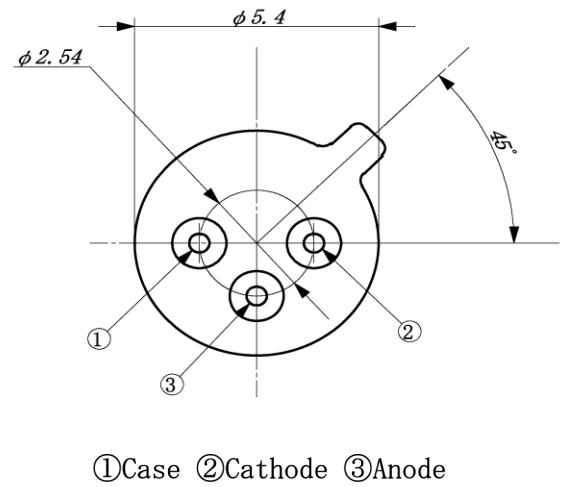

①Case ②Cathode ③Anode

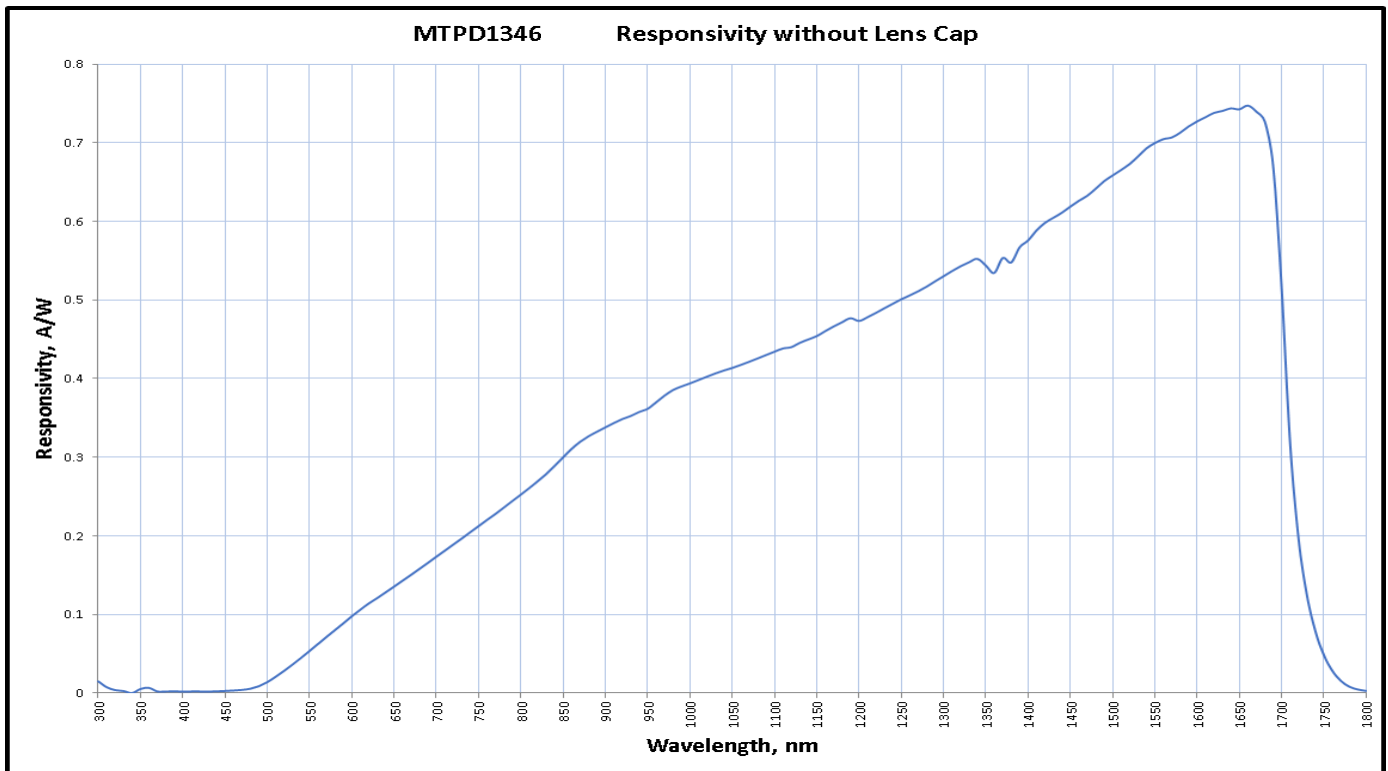

The information contained herein is subject to change without notice.

2019-02-14

X-ON Electronics

Largest Supplier of Electrical and Electronic Components

Click to view similar products for [Photodiodes](#) category:

Click to view products by [Marktech](#) manufacturer:

Other Similar products are found below :

[LTR-526AD](#) [OED-SP-7L](#) [LTR-536AB](#) [LTR-743DBM1-TA](#) [67-21SYGC-S349-TR8](#) [SFH 2200 A01](#) [HFD3081-108-XBA](#) [BPW 34 S E9601](#)
[SFH 2713](#) [SFH 2703](#) [LTR-546AD](#) [BPV23FL](#) [BPW 34 FAS](#) [BPW 34 FS](#) [IG17X1000S4I](#) [IG22X250S4I](#) [VTD205H](#) [VTD205KH](#)
[VTP1232FH](#) [VTP4085H](#) [SFH 2400](#) [OP913WSL](#) [OPF794](#) [PD70-01C/TR7](#) [LTR-536AD](#) [VTP8651H](#) [VTD206KH](#) [VTB1013H](#) [BPV23NF](#)
[OP905](#) [LTR-516AD](#) [BPW 34 FS-Z](#) [VTD34FH](#) [QSB34CGR](#) [SFH 2500 FA](#) [PD15-22C/TR8](#) [VEMD5510C](#) [SFH 2200](#) [VEMD5510CF](#)
[SAH230M](#) [SAH230M2](#) [SAH500M2](#) [MTAPD-07-010](#) [BP 104 FS](#) [BPV22F-AS12](#) [BPW 21](#) [BPW 34 SR-Z](#) [BPX 65](#) [HSDL-5400#011](#) [BPW](#)
[34 FASR](#)