

Peak Emission Wavelength: 855nm

The 850nm Point Source Series is designed for applications requiring high accuracy and precision as well as uniform spectral emission. Custom package solutions and sorting are available.

FEATURES

- > Hermetically Sealed Pigtail Package
- > Emitting Window Diameter Φ 150 μ m
- > Gold Plated Dome Lens
- > High Reliability / High Output Power

- > Extremely Narrow Radiation Pattern

APPLICATIONS

- > Optical Scanning / Optical Sensors
- > Linear & Rotary Encoder
- > Edge Sensing

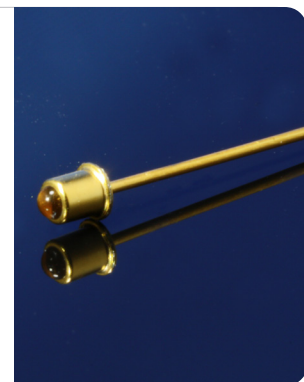

Absolute Maximum Ratings (Ta=25°C)



ITEMS	SYMBOL	RATINGS	UNIT
Forward Current (DC)	IF	80	mA
Forward Current (Pulse)*1	IFP	0.4	A
Reverse Voltage	VR	5	V
Power Dissipation	PD	140	mW
Operating Temperature Range	Topr	-20 ~ +85	°C
Storage Temperature Range	Tstg	-30 ~ +100	°C

*1: Tw=10 μ sec, T=10msec.

Electrical & Optical Characteristics (Ta = 25°C)

ITEMS	SYMBOL	CONDITIONS	MIN	TYP	MAX	UNIT
Power Output	PO	IF=50mA	1.2	2.0	--	mW
Forward Voltage	VF	IF=50mA	--	1.7	2.2	V
Reverse Current	IR	VR=5V	--	--	100	μ A
Peak Emission Wavelength	λ_p	IF=50mA	--	855	--	nm
Spectral Line Half Width	$\Delta\lambda$	IF=50mA	--	30	--	nm
Half Intensity Beam Angle	Θ	IF=50mA	--	± 5	--	deg

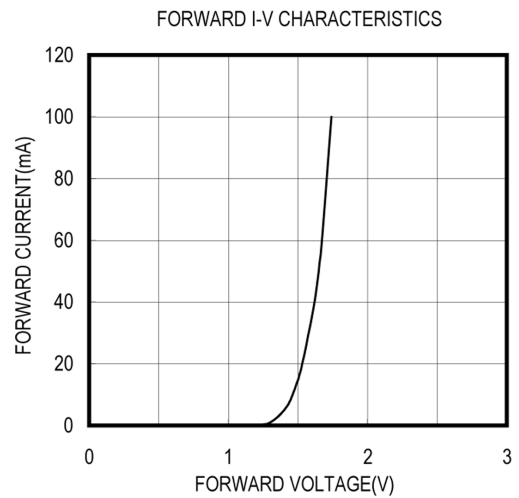
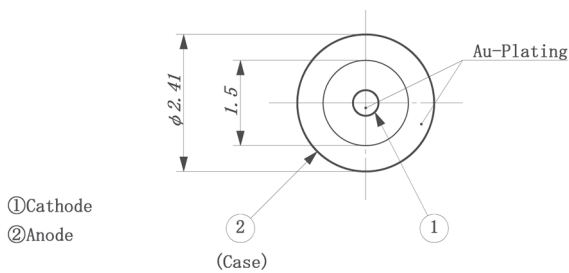
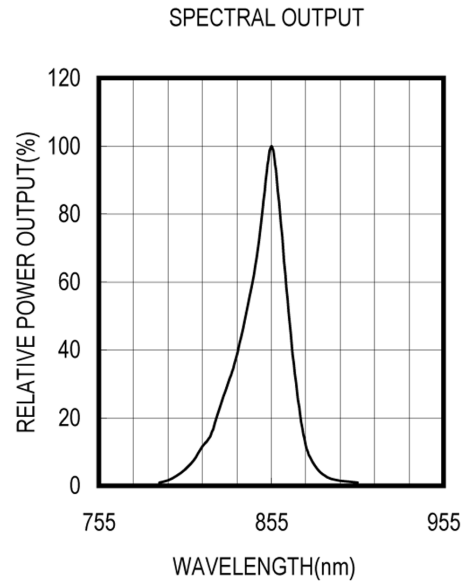
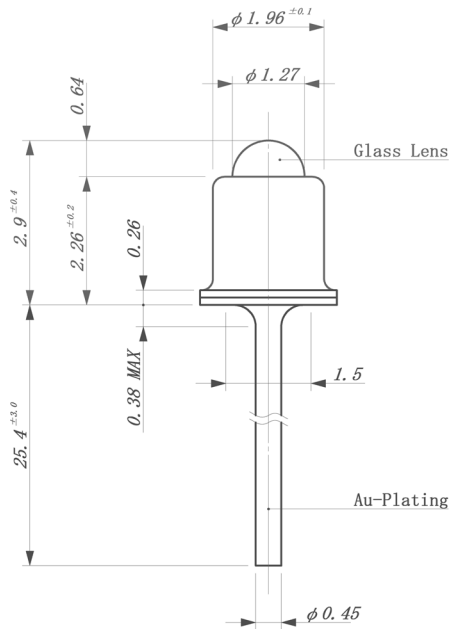

Unit: mm, Tolerance: ±0.2

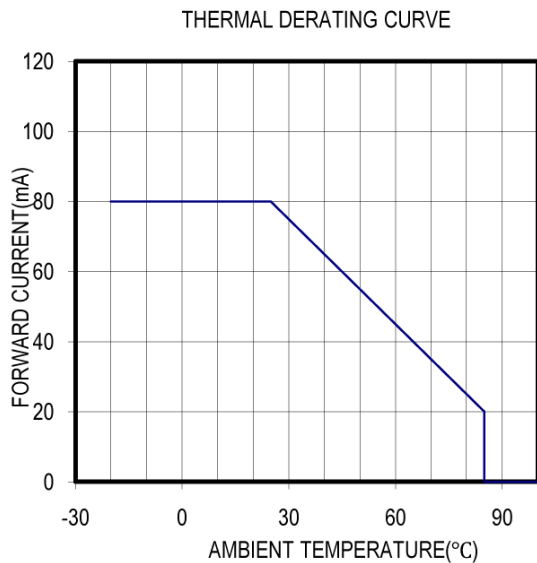
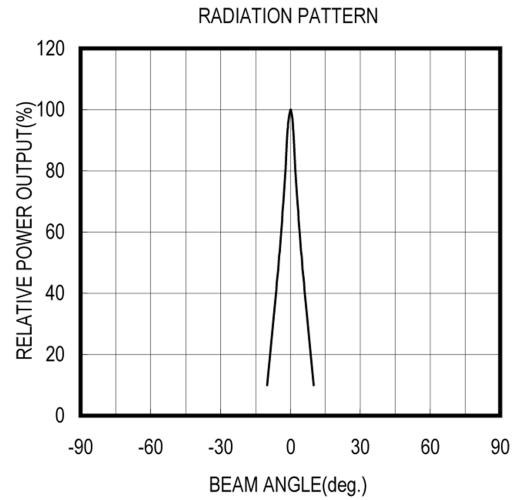
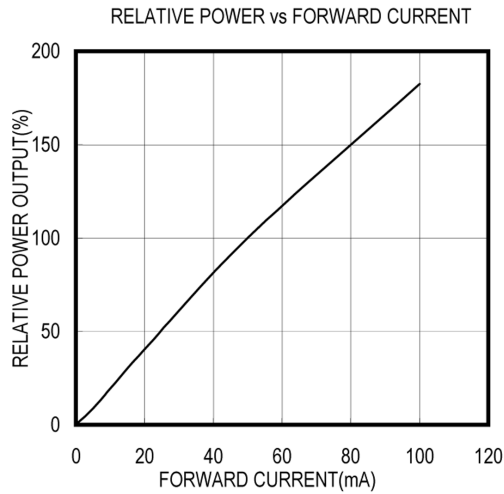

The information contained herein is subject to change without notice.

2011-05-23

X-ON Electronics

Largest Supplier of Electrical and Electronic Components

Click to view similar products for [Infrared Emitters](#) category:

Click to view products by [Marktech](#) manufacturer:

Other Similar products are found below :

[LTE-309](#) [LTE-3279K](#) [LTE-4206C](#) [LTE-4208C](#) [EAILP03RDAA6](#) [LTE-2871C](#) [LTE-4238](#) [ASDL-4264-C22](#) [OED-EL305F4C50-HT](#) [OP216-004](#) [LTE-3376](#) [EEL109](#) [HL-PST-1608IR1C-L4](#) [SFH 7016](#) [IN-S126DSHIR](#) [IN-S126ETHIR](#) [IN-S42CTQHIR](#) [IN-S63FTHIR](#) [MHT153IRCT](#) [MHS153IRCT](#) [HIR204C/H0](#) [LTE-209](#) [IR12-21C/TR8](#) [IR17-21C/TR8](#) [IR26-21C/L110/TR8](#) [IR91-21C/TR10](#) [L-53F3BT](#) [WP3A10F3C](#) [LTE-4208](#) [IR42-21C/TR8](#) [HSDL-4261](#) [APA3010F3C-GX](#) [SE2460-140](#) [OP266-905](#) [OP280D](#) [LTE-2871](#) [HIR8323/C16](#) [KP-2012SF4C](#) [KPA-3010F3C](#) [HIR19-21C/L11/TR8](#) [IR19-21C/TR8](#) [IR11-21C/TR8](#) [IR204/H60](#) [HIR204C](#) [WP7113SF6BT-P22](#) [AP2012SF4C-P22](#) [AA3528SF4S](#) [350-00003](#) [AP2012F3C](#) [MTE6000L-HP](#)