

Peak Sensitivity Wavelength: 855nm

The 855nm Point Source Series is designed for applications requiring high output and precise optical / mechanical axis alignment. Custom package solutions and sorting are available.

FEATURES

- > TO-18 Metal Can Package
- > Emitting Window Diameter $\Phi 150\mu\text{m}$
- > High Reliability
- > Wide Beam Angle

APPLICATIONS

- > Optical Switches / Security Systems
- > Linear & Rotary Encoder
- > Remote Controls / Robotics
- > Fiber Applications

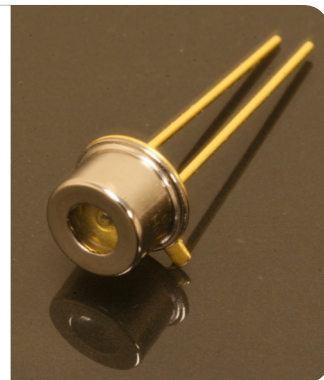

Absolute Maximum Ratings (Ta=25°C)



ITEMS	SYMBOL	RATINGS	UNIT
Forward Current	IF	100	mA
Forward Current (Pulse)*1	IFP	0.8	A
Reverse Voltage	VR	5	V
Power Dissipation	PD	190	mW
Operating Temperature Range	Topr	-20 ~ +85	°C
Storage Temperature Range	Tstg	-30 ~ +100	°C
Junction Temperature	Tj	100	°C
Lead Soldering Temperature*2	Tls	260	°C

*1: Tw=10μsec, T=10msec. *2: Time 5 Sec max, Position: Up to 3mm from the body.

Electrical & Optical Characteristics (Ta = 25°C)

ITEMS	SYMBOL	CONDITIONS	MIN	TYP	MAX	UNIT
Power Output	PO	IF=50mA	--	2.70	--	mW
Forward Voltage	VF	IF=50mA	--	1.59	--	V
Reverse Current	IR	VR=5V	--	--	100	μA
Peak Emission Wavelength	λ_p	IF=50mA	--	855	--	nm
Spectral Line Half Width	$\Delta\lambda$	IF=50mA	--	31	--	nm
Half Intensity Beam Angle	Θ	IF=50mA	--	+/-50	--	deg

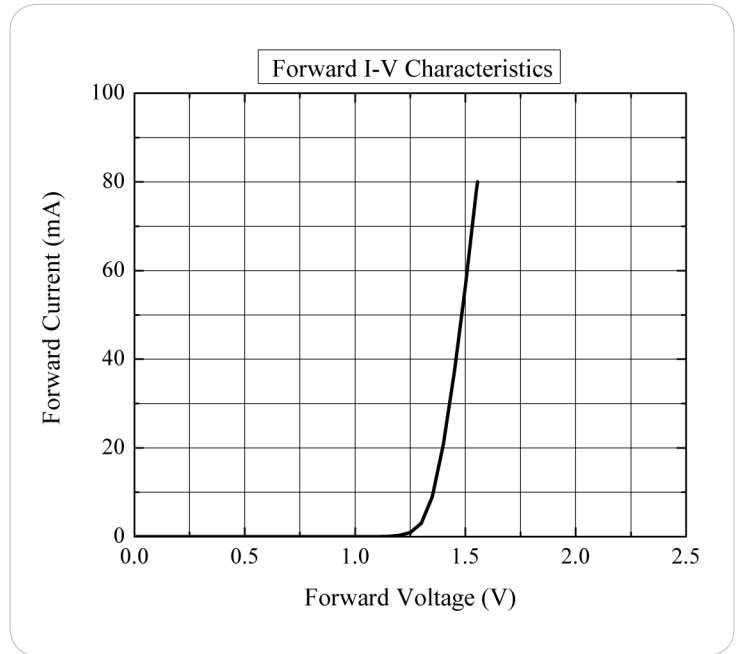
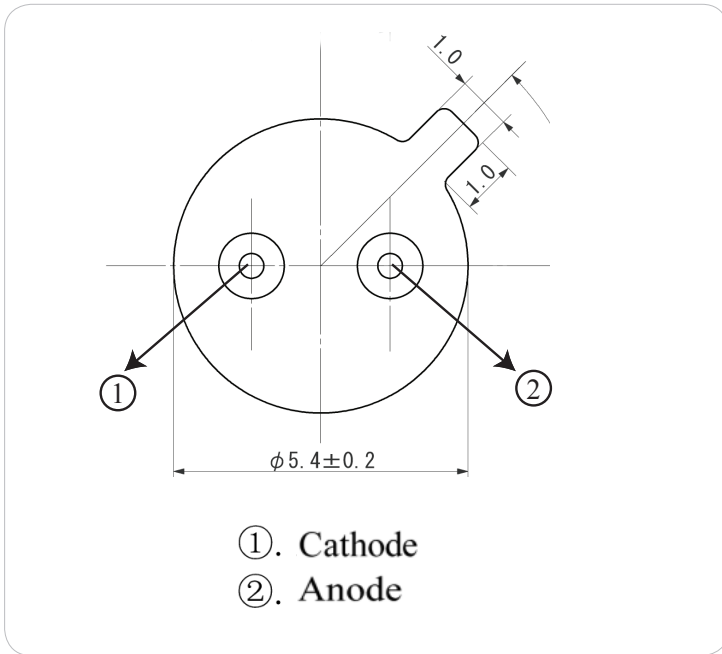
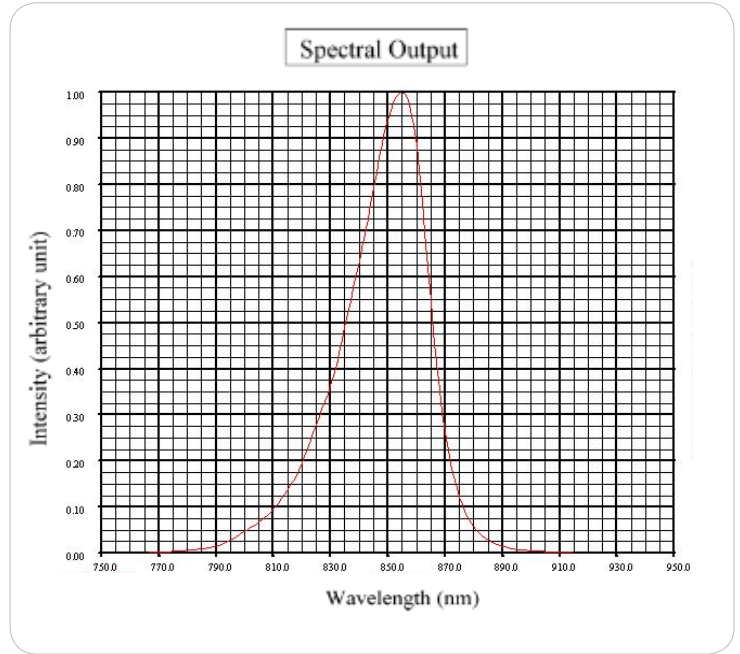
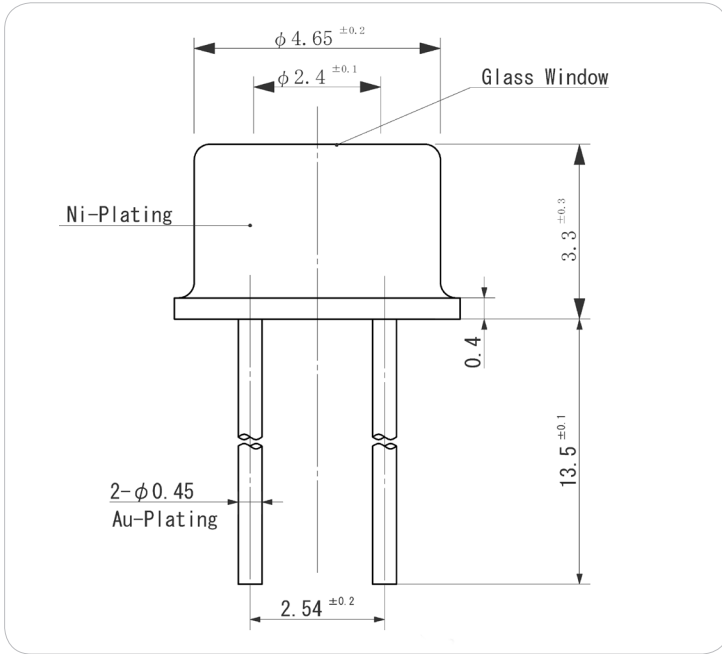

Unit: mm, Tolerance: ± 0.2

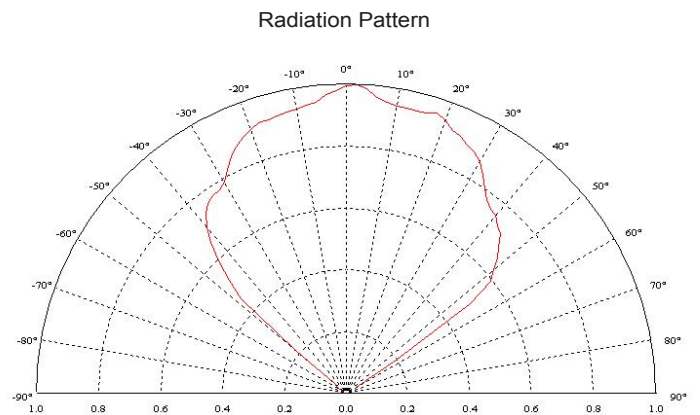
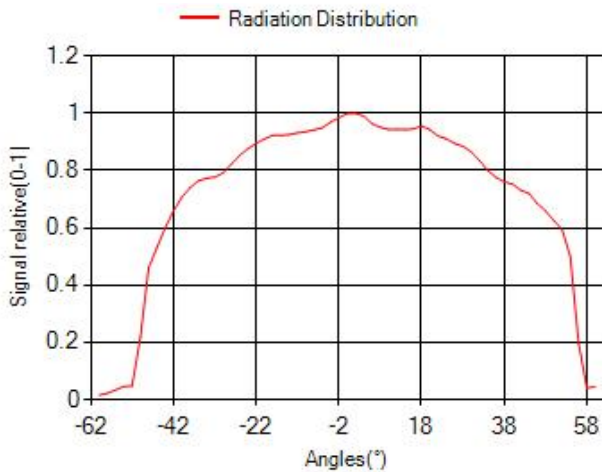
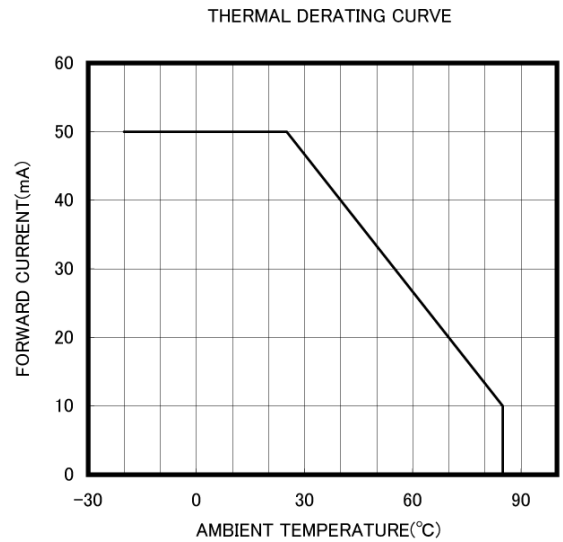
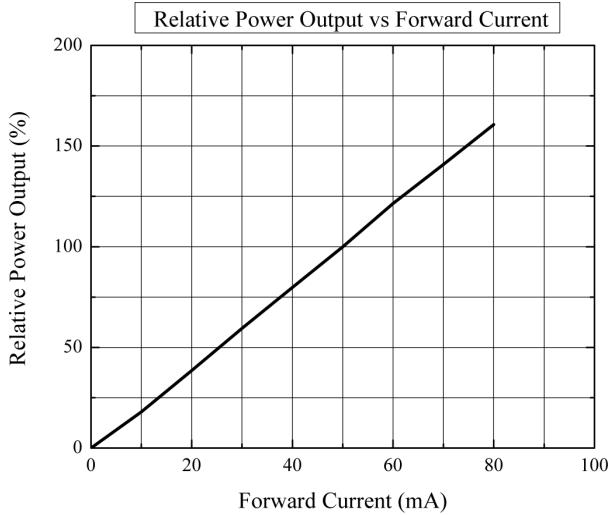

The information contained herein is subject to change without notice.

2018-07-12

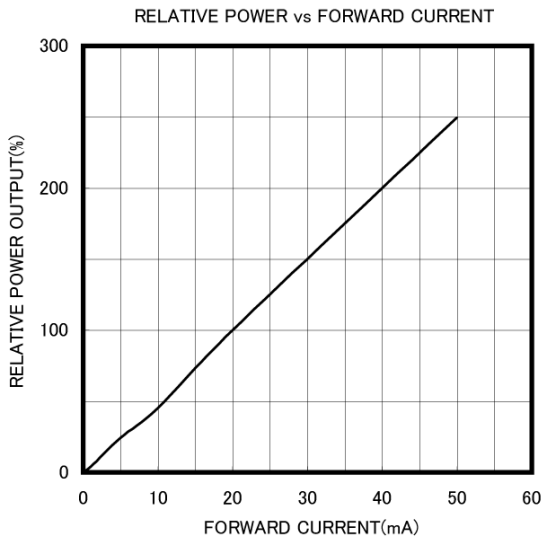

The information contained herein is subject to change without notice.

2018-07-12

X-ON Electronics

Largest Supplier of Electrical and Electronic Components

Click to view similar products for [Infrared Emitters](#) category:

Click to view products by [Marktech](#) manufacturer:

Other Similar products are found below :

[LTE-3279K](#) [LTE-4206C](#) [LTE-4208C](#) [IR333C](#) [LTE-2871C](#) [LTE-4238](#) [ASDL-4264-C22](#) [OED-EL305F4C50-HT](#) [LTE-3376](#) [IN-S126ETIR](#)
[IN-S126DSHIR](#) [IN-S126ETHIR](#) [IN-P32ZTHIR](#) [IN-S42CTQHIR](#) [IN-S126BTHIR](#) [IN-S63DTHIR](#) [IN-S85BTHIR](#) [IN-S63FTHIR](#)
[EAIST3535A4](#) [XL-1608HIRC-850](#) [XL-2012HIRC-850](#) [LTE-C216-P-W](#) [ZIR-1608C-06A-Z4](#) [ZIR-3528C-18-Z2](#) [ZIR-3216C-19-R15](#) [XL-](#)
[2012IRC-940](#) [XL-3216IRC-940](#) [XL-3216HIRC-850](#) [LTE-C9901](#) [MHT130ZVRCT](#) [DY-IRS302320C/3T](#) [HIR204C/H0](#) [HIR323C](#) [LTE-209](#)
[IR12-21C/TR8](#) [IR17-21C/TR8](#) [IR26-21C/L110/TR8](#) [IR91-21C/TR10](#) [KM-4457F3C](#) [L-53F3BT](#) [WP3A10F3C](#) [LTE-4208](#) [OP235W](#) [IR42-](#)
[21C/TR8](#) [HSDL-4261](#) [APA3010F3C-GX](#) [SE2460-140](#) [KP-2012SF4C](#) [KPA-3010F3C](#) [L-7113SF6C](#)