

## Peak Emission Wavelength: 1625nm

The MTRS5116C reflective sensor consists of a 1625nm infrared emitter and high sensitivity InGaAs photodiode in the same package. The black molded housing reduces the effect of external ambient light. Custom emitter/detectors are available.

### FEATURES

- > 1.00mm Active Area
- > 5.1 x 3.3mm Surface Mount Package
- > Short Detection Distance Optimum 0.5-1.5mm

### APPLICATIONS

- > Card Reader
- > Bar-code Reader
- > Edge Sensing / Money-bill Reader

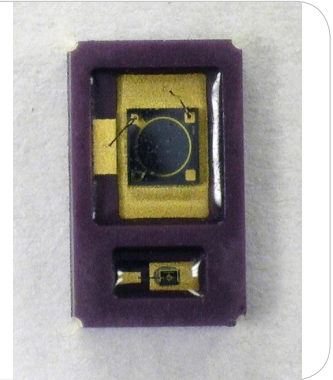

## Absolute Maximum Ratings (Ta=25°C)



ITEMS	SYMBOL	RATINGS	UNIT
Forward Current (LED)	IF	40	mA
Pulse Forward Current (LED)*1	IFP	0.5	A
Reverse Voltage (LED)	VR	5	V
Power Dissipation (LED)	PD	100	mW
Reverse Voltage (PD)	VR (IR=10uA)	3	V
Reverse Current (LED)	IR (VR=5V)	10	uA
Operating Temperature Range	Topr	-20 to +80	°C
Storage Temperature Range	Tstg	-30 to +100	°C

\*1: Tw=10µsec, T=10msec.

## Electrical & Optical Characteristics (Ta = 25°C)

ITEMS	SYMBOL	CONDITIONS	MIN	TYP	MAX	UNIT
Forward Voltage (LED)	VF	IF=20mA	--	0.87	--	V
Peak Emissions Wavelength (LED)	$\lambda_p$	IF=20mA	--	1625	--	nm
Spectral Line Half Width (LED)	$\Delta\lambda$	IF=20mA	--	120	--	nm
Power Output (LED)	PO	IF=20mA	--	0.71	--	mW
Reverse Dark Current (Iceo)	ID	VR=1V	--	2.0	--	uA
Light Current @1300nm	IL	$\lambda=1300\text{nm}$ ; VR=2V	--	180	--	uA
Shunt Resistance	RSH	VR=10mV	--	2	--	MΩ
Sensitivity Range	V	VR=0V	600	--	1750	nm
Responsivity	R	$\lambda=1550\text{nm}$	--	0.70	--	A/W
Quantum Efficiency	QE	$\lambda=1660\text{nm}$	--	55	--	%
Total Capacitance	CT	VR=0V	--	60	--	pF
Rise/Fall Time (10 to 90%)	Tr, Tf	VR=10V, IF=20mA, RL=1KΩ	--	--	--	uS

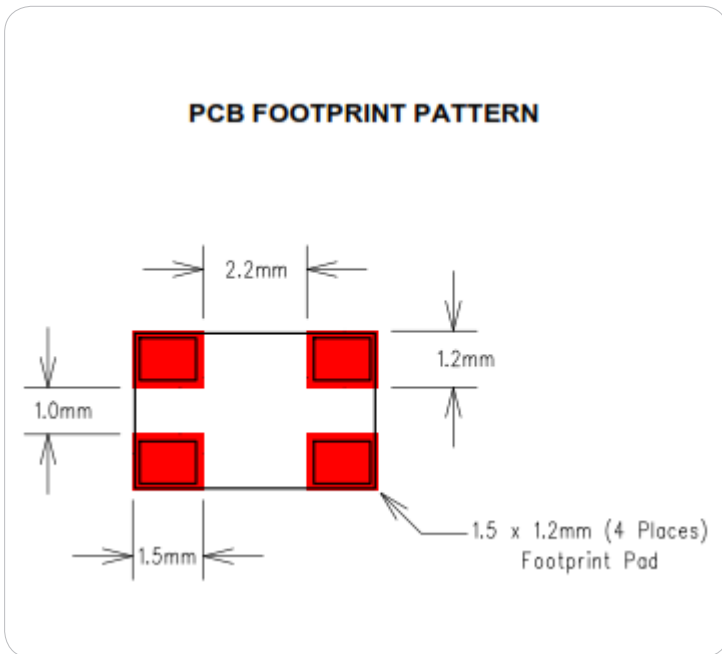
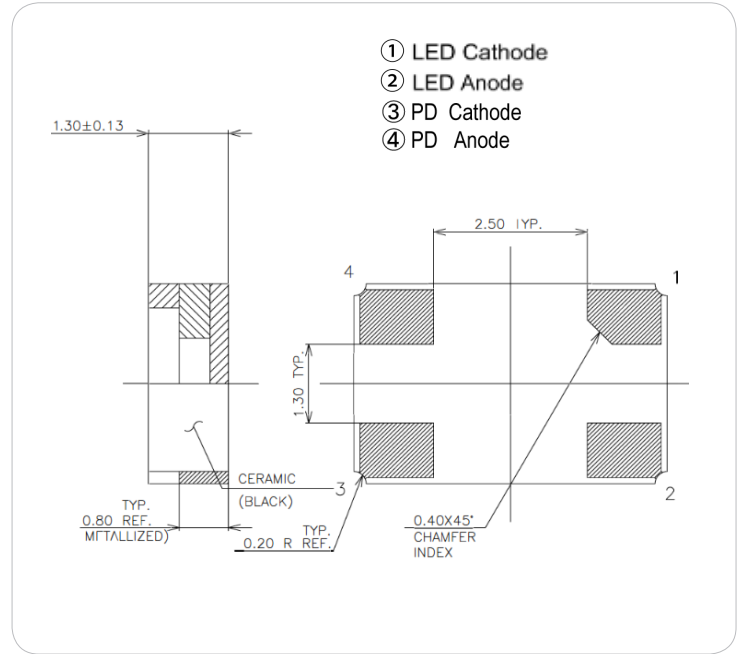
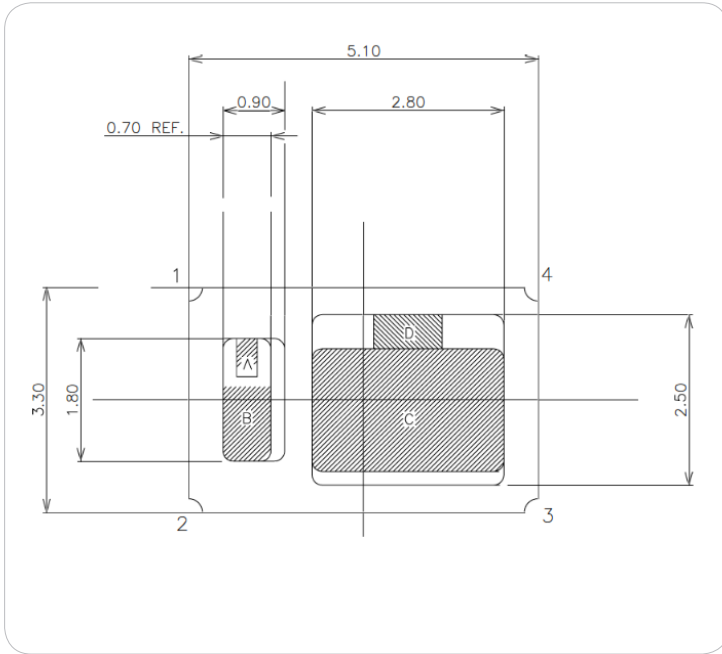

Unit: mm, Tolerance: ±0.2

2021-05-27

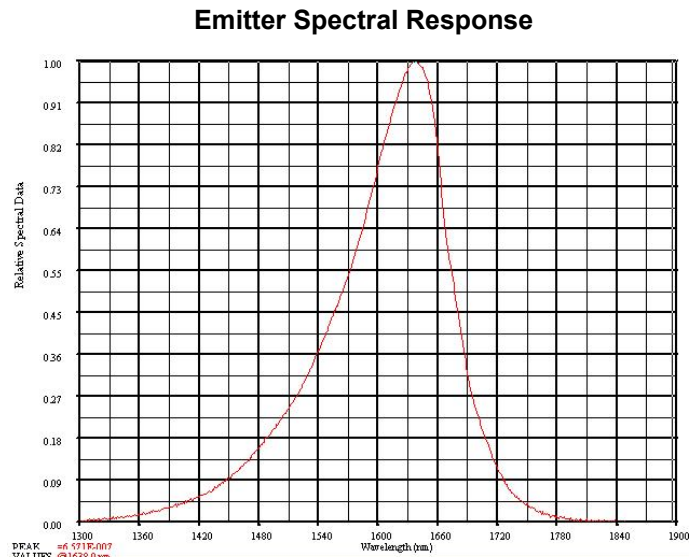
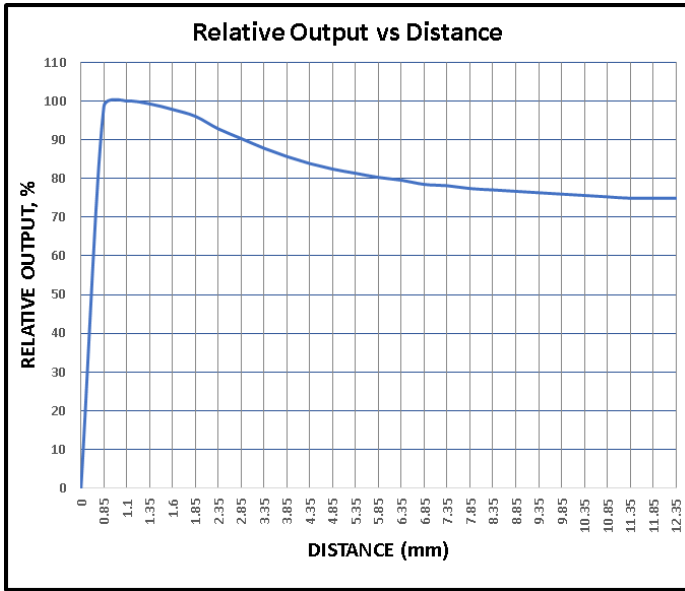

Unit: mm, Tolerance: ±0.2

2021-05-27

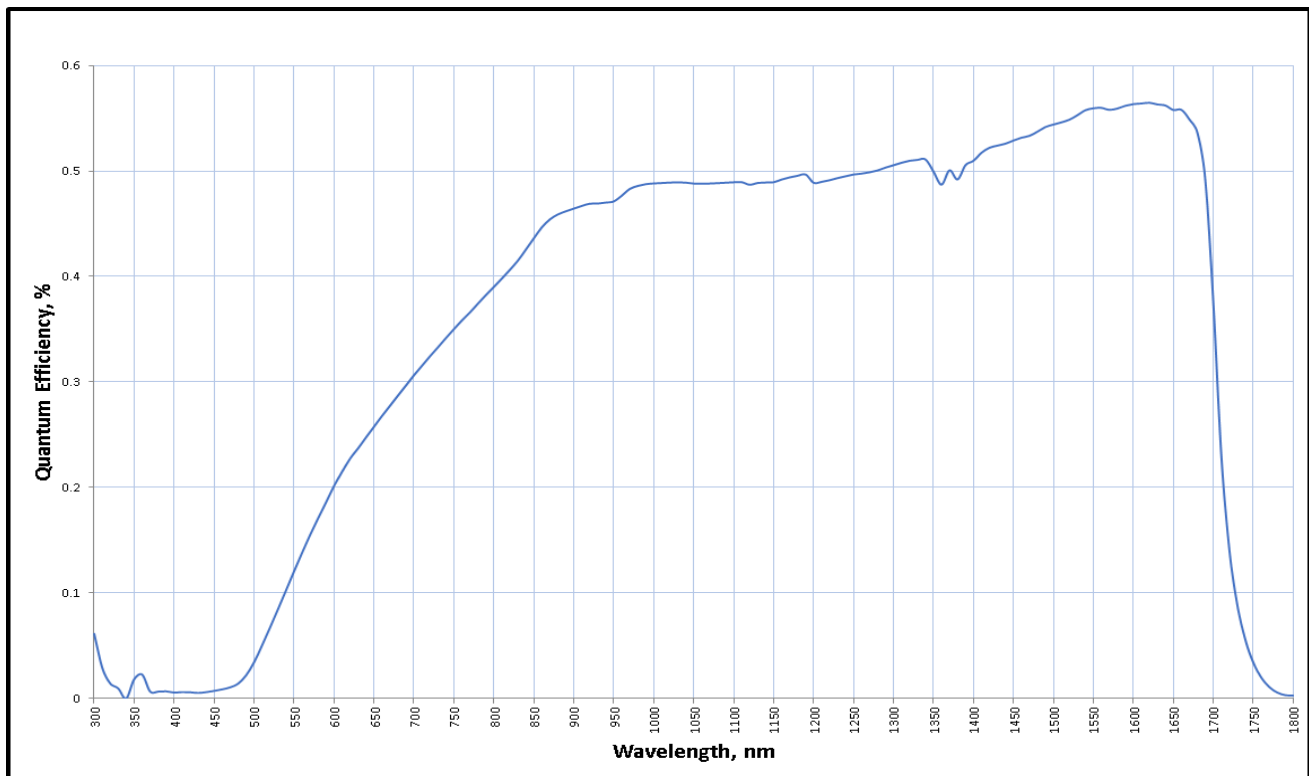
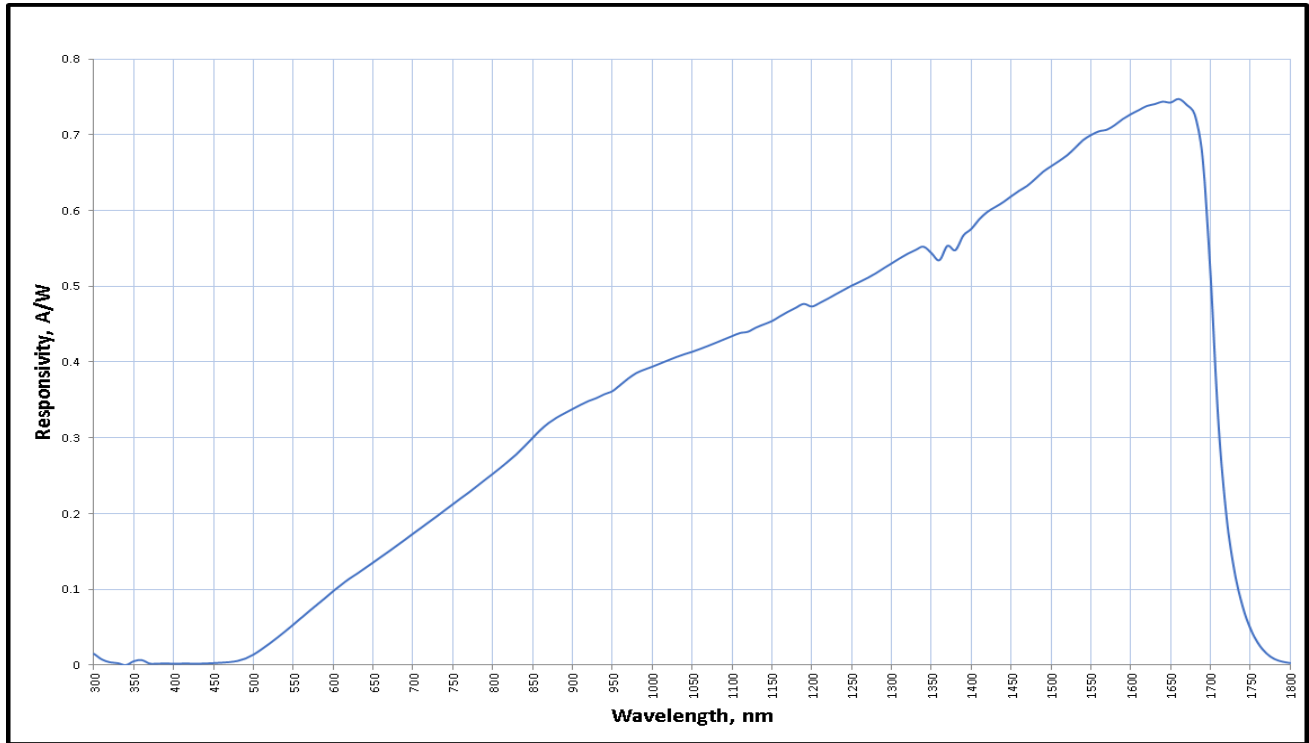

2021-05-27

## **X-ON Electronics**

Largest Supplier of Electrical and Electronic Components

*Click to view similar products for [Optical Switches](#), Specialised *category*:*

*Click to view products by [Marktech](#) manufacturer:*

Other Similar products are found below :

[HOA6394-001](#) [HOA6506-001](#) [HOA6241-003](#) [HOA6109-002](#) [HOA6323-101](#) [MTRS6660](#) [MTRS5250D](#) [MTRS4720D](#) [MTRS6660D](#)  
[MTRS0012C](#) [MTRS0013C](#) [MTRS5116C](#) [MTRS4010C](#) [MTRS7010C](#) [MTRS9520D](#) [NJL5310R-TE1](#) [EE-SPZ301](#) [OPB355T](#) [TCND5000](#)  
[OPB621](#)