

### Sensitivity Wavelength Range: 800nm~2600nm

The MTSM2601SMF1-030 from Marktech, a high sensitivity and high reliability product series, is ideally suited for Optical Communication devices. Custom packaging options for this die is also available.

**FEATURES**

- > High Speed Response
- > 3mm x 3mm Seam Welded Surface Mount Package
- > Active Area of 0.3mm  $\Phi$  / High Sensitivity
- > Spectral Range 800nm - 2600nm
- > Hermetically Sealed

**APPLICATIONS**

- > High Speed Optical Communications
- > Industrial Controls
- > Gas/Water Analysis
- > LIDAR
- > Medical

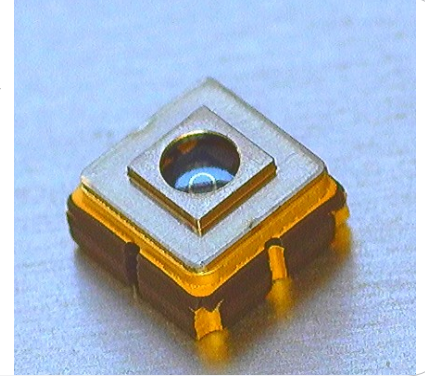

### Absolute Maximum Ratings (Ta=25°C)



ITEMS	SYMBOL	RATINGS	UNIT
Active Area	$\Phi$	0.3	mm
Operating Temperature Range	Topr	-40 to +85	°C
Storage Temperature Range	Tstg	-40 to +125	°C

### Electrical & Optical Characteristics (Ta = 25°C)

ITEMS	SYMBOL	CONDITIONS	MIN	TYP	MAX	UNIT
Breakdown Voltage	VR	IR=100uA	--	--	1	V
Sensitivity Range	$\lambda$	VR=0V	800	--	2600	nm
Dark Current	ID	VR=0V	--	1	--	nA
Dark Current	ID	VR=1V	--	43	--	uA
Capacitance	C	VR=0V	--	150	--	pF
Capacitance	C	VR=1V	--	20	--	pF
Responsivity	R	$\lambda=2400\text{nm}$	--	1.24	--	A/W
Shunt Resistance	RS	VR=10mV	--	9	--	kOhm
Quantum Efficiency	QE	$\lambda=1840\text{nm}$	--	72	--	%
Light Current @ $\lambda=1300\text{nm}$	IL	If=10mA	--	25	--	$\mu\text{A}$
Light Current @ $\lambda=1300\text{nm}$	IL	If=20mA	--	50	--	$\mu\text{A}$

Package Dimensions

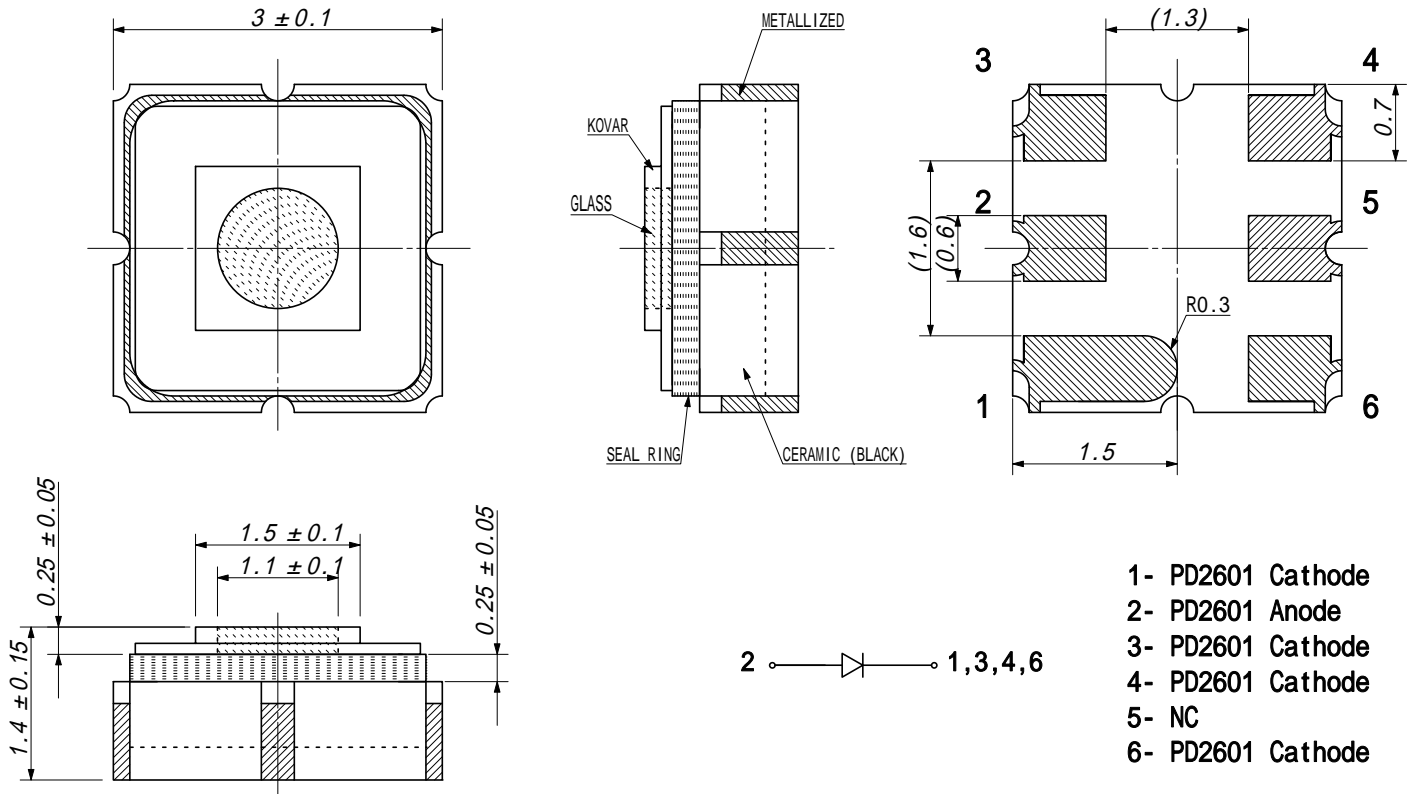

- 1- PD2601 Cathode
- 2- PD2601 Anode
- 3- PD2601 Cathode
- 4- PD2601 Cathode
- 5- NC
- 6- PD2601 Cathode

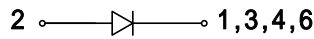

Unit: mm, Tolerance: ±0.2

The information contained herein is subject to change without notice.

2022-12-8

### Spectral Responsivity

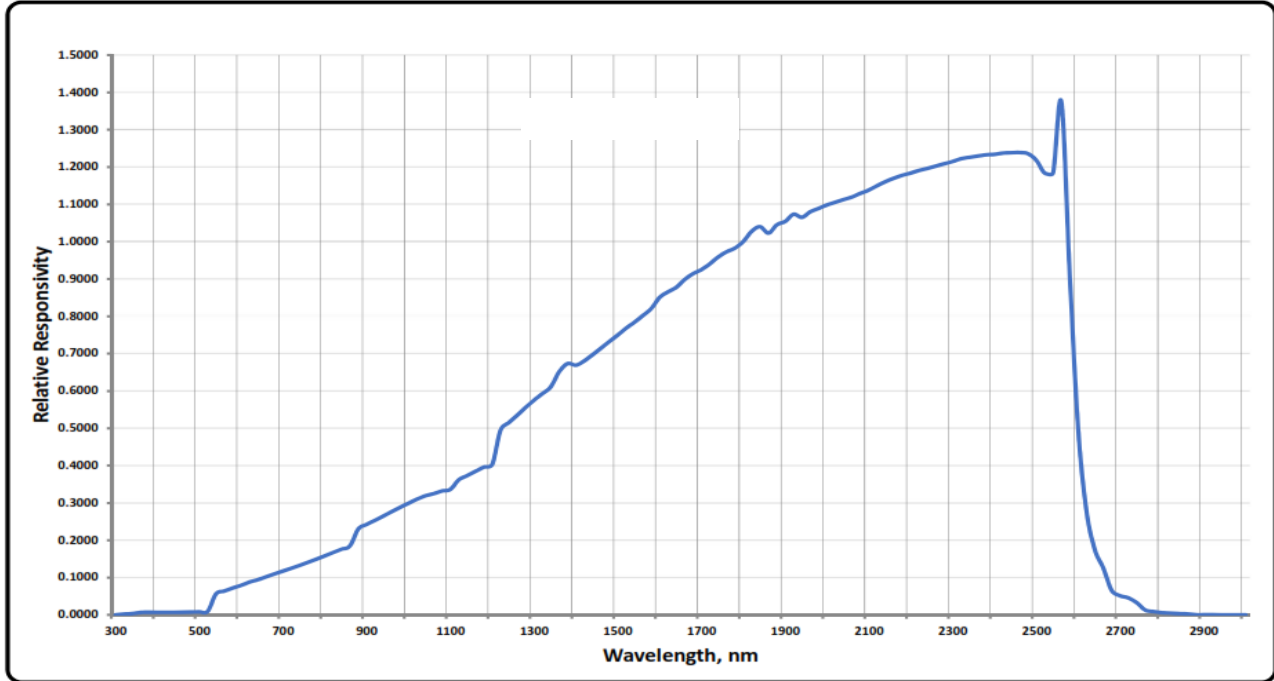

### Quantum Efficiency

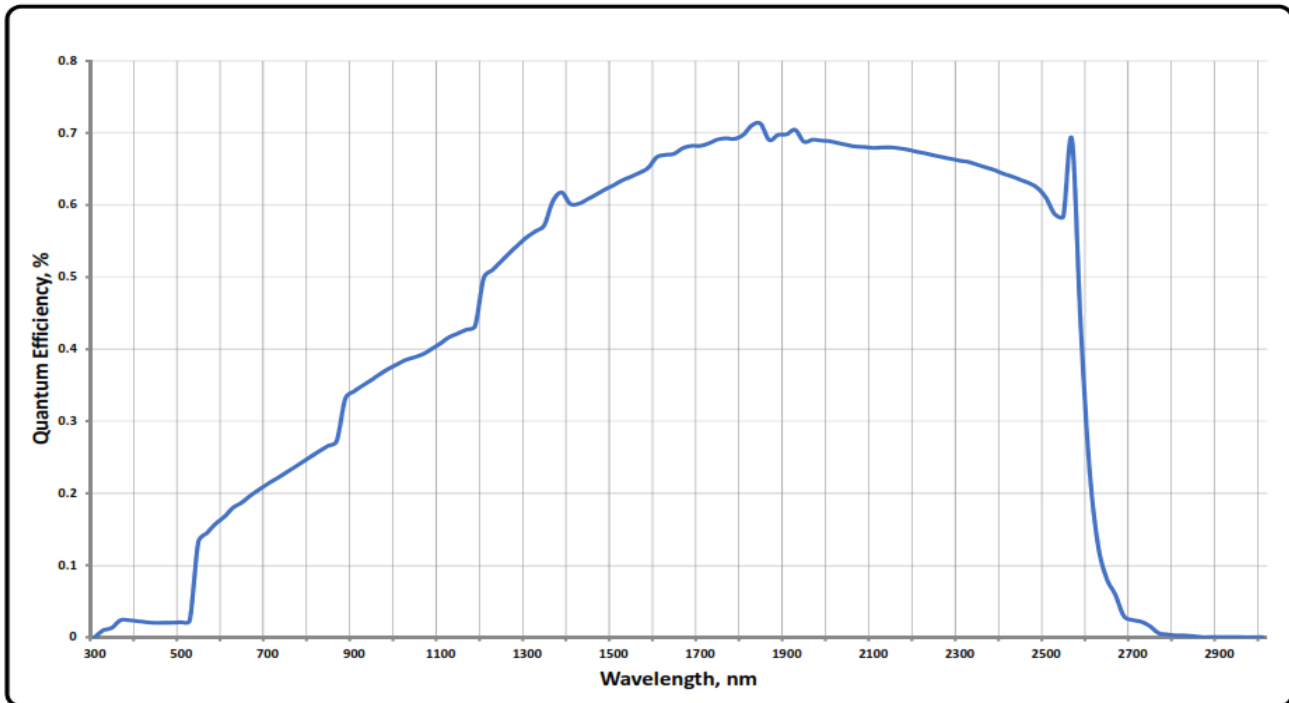

The information contained herein is subject to change without notice.

2022-12-8

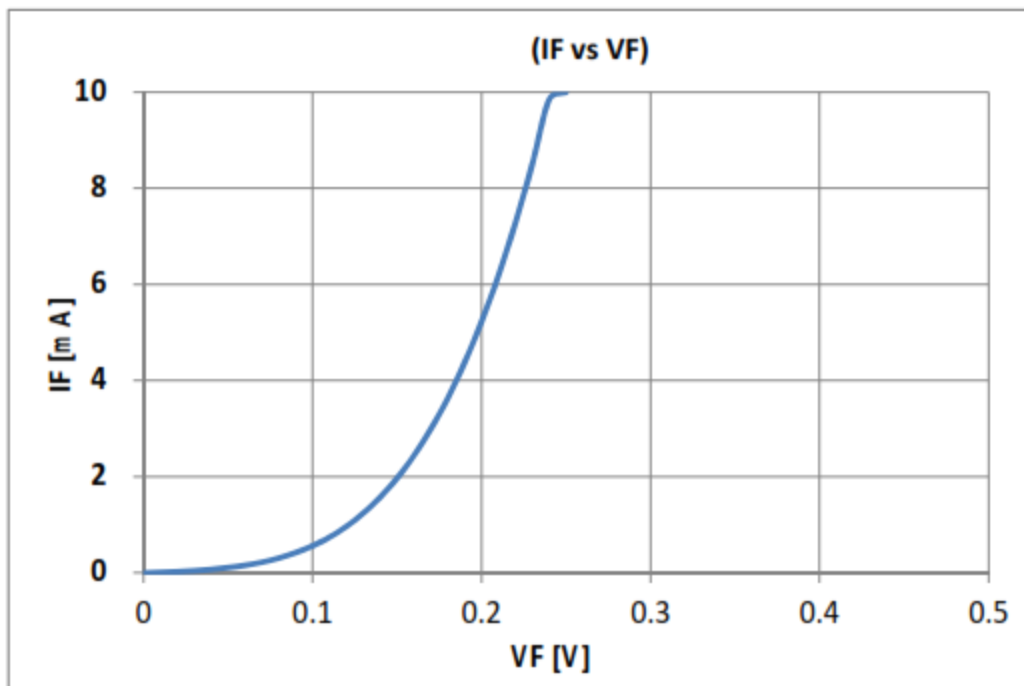
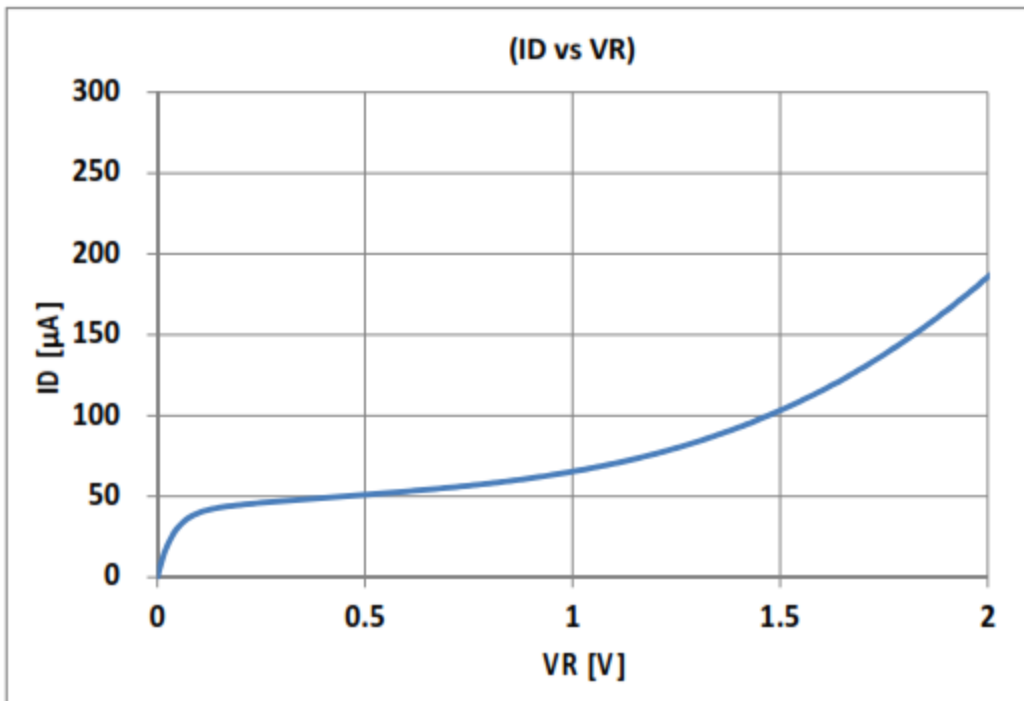

The information contained herein is subject to change without notice.

2022-12-8

## X-ON Electronics

Largest Supplier of Electrical and Electronic Components

*Click to view similar products for [Photodiodes](#) category:*

*Click to view products by [Marktech](#) manufacturer:*

Other Similar products are found below :

[BPW 34 FAS-Z](#) [67-21SYGC-S349-TR8](#) [HFD3081-108-XBA](#) [BPW 34 S E9601](#) [MICROFJ-60035-TSV-TR](#) [ZSPD-Z3215B-10-Z2](#) [PT908-7B\(BIN4\)](#) [PT204-6B\(BY\)\(K\)](#) [PT928-6C/MA\(XBY\)](#) [PT908-7C\(BIN5\)](#) [PT968-8B\(6-2\)](#) [PT968-8C\(6-1\)](#) [PT204-6B\(BY\)\(J\)](#) [PT968-8B\(6-1\)](#) [PD70-01C/TR7\(BY\)](#) [PT968-8C\(6-2\)](#) [XYC-PD3020F90-S3](#) [ZSPD-Z3215C-10A-Z2](#) [ZSPD-Z3227B-10C-Z3](#) [ZSPD-Z3227C-10-Z3](#) [PD15-22C/TR8\(BY\)](#) [ZPD-Z3224B-T26-T15\(YPX\)](#) [ZSPD-Z5042C-A10-Z1](#) [ZSPD053B-S40](#) [PT334-6C\(BY\)\(K\)](#) [PT968-8C\(X1-X4\)XBY](#) [PT334-6B\(BY\)\(K\)](#) [PT928-6C\(5-2\)](#) [PT334-6B\(BY\)\(L\)](#) [PT333-3B\(BY\)\(K\)](#) [PT334-6B\(BY\)\(M\)](#) [XYC-PD2835F30-F1](#) [XYC-PD204B-L1](#) [XYC-PD3A940FC-F1](#) [XYC-PD4335F90-E2](#) [ZSPD808B](#) [ZSPD818B](#) [ZSPD034B-N](#) [ZSPD888C](#) [ZSPD053B-90-S90](#) [PD234-6B/L3](#) [PD70-01C/TR7\(ORI\)](#) [NCD2516RGI1](#) [NCD3220S1](#) [NCD4437S1](#) [NCD1816RGI1](#) [XYC-PD333B-L2](#) [XYC-PD5AB940DC-E9](#) [XL-504PDC](#) [XL-304PDC](#)